

HPVS / EVS v3-6 1991-1998 ***TECHNICAL DOCUMENTATION***

Descriptions
Working
Maintenance
Diagnosis
Operation

© 2005 Ginaf Trucks bv, Veenendaal, The Netherlands.

Ginaf reserves the right to change specifications or products at any time without prior notice.

No part of this publication may be reproduced and/or published by printing, by photocopying, on microfilm or in any way whatsoever without the prior consent in writing of Ginaf Trucks bv

OG0000088888

Contents

Preface	1-1
1.1 General	1-1
1.2 List of versions	1-1
Power supply	2-1
HPVS	3-1
3.1 Description	3-1
3.1.1 Suspension	3-1
3.1.2 Damping	3-2
3.1.3 Stabilisation	3-2
3.1.4 Height control	3-2
3.1.5 Lateral control	3-3
3.2 Components	3-3
3.2.1 Spring cylinders	3-4
3.2.2 Hoses and pipes	3-5
3.2.3 Test nipples	3-5
3.2.4 Accumulators	3-5
3.2.5 Hydraulic pump-unit	3-7
3.2.6 Filtering	3-7
3.2.7 Oil	3-7
3.2.8 ALR (hydraulic control)	3-8
3.3 Operation	3-8
3.3.1 Height control	3-8
3.3.2 Hydraulic lateral stabilisation	3-11
3.3.3 Hydraulic lateral stabilisation: superstab	3-12
3.3.4 Lateral levelling control	3-13
3.3.5 Container lifting system	3-13
3.3.6 Lifting axle (v3/3)	3-13
3.3.7 Manifold-block	3-16
3.3.8 Hydraulic diagrams	3-17
EVS	4-1
4.1 General	4-1
4.2 Description of components	4-2
4.2.1 Steering cylinders	4-2
4.2.2 Emergency steering accumulator	4-3
4.2.3 Sensors	4-3
4.2.4 ECU	4-4
4.3 Operation; EVS cylinders	4-5
4.3.1 Centre position	4-5
4.3.2 Steering left	4-6
4.3.3 Steering right	4-7
4.4 Operation; hydraulic diagram	4-8
4.4.1 The steering system	4-8

4.4.2	The emergency steering system	4-9
4.4.3	Steering left	4-12
4.4.4	Steering right	4-13
4.4.5	Rear axle in centre position	4-14
4.4.6	Rear axle in centre position, high speed	4-15
4.4.7	Change of position of the EVS switch	4-16

Electrical system

5.1	Components	5-1
5.1.1	Proximity switches (height control)	5-1
5.1.2	Fuses	5-3
5.2	Functions	5-3
5.2.1	Lateral levelling control	5-3
5.2.2	Container lifting system	5-4
5.2.3	Hydraulic lateral stabilisation	5-4
5.2.4	Hydraulic lateral stabilisation: superstab	5-5
5.3	Switches and warning lamps	5-5
5.3.1	G-series switches until 1995	5-5
5.3.2	G-series warning lamps until 1995	5-7
5.3.3	M and G-series switches from 1995 to 1998	5-7
5.3.4	M and G-series warning lamps from 1995 to 1998	5-9
5.4	Software	5-9
5.4.1	Zero point hysteresis	5-9
5.4.2	Counter-steering factor	5-10
5.4.3	Proportional back-steering effect	5-10
5.4.5	Correction factor	5-10
5.4.6	Synchronisation of both cylinders	5-11
5.4.7	Existing hysteresis	5-11
5.5	Fault messages	5-11
5.5.1	Via the DCS-1 diagnostics unit	5-11
5.5.2	Via flashing code	5-12
5.5.3	Overview of fault messages	5-13
5.6	Electrical diagrams	5-17
5.6.1	Overview of connectors and trimming potentiometers in e3 ECU	5-18
5.6.2	Overview of circuit diagrams for M series	5-18
5.6.3	Overview of circuit diagrams for G series	5-38

Chapter1

Preface

Since 1986 GINAF Trucks has used the Hydro-Pneumatic Vehicle Suspension (HPVS) on various models of vehicle. This involved replacing the conventional (mechanical or air) suspension system by hydraulic cylinders.

In 1991 the Electronic Vehicle Steering (EVS) system was launched, which in combination with HPVS makes for sophisticated possibilities.

In this documentation attention will be given to the description, functioning, maintenance, diagnostics and operation of the HPVS and EVS.

1.1 General

This documentation contains information about the HPVS suspension system and the EVS steering system that were used on GINAF vehicles from about 1991 until 1998. During these production years different variants of the system were used, i.e. versions 3/3 and v6/0. Both of these variants will therefore be discussed.

Since the various versions can be used on different GINAF models, only “versions” will be referred to in this and subsequent chapters. For clarity’s sake, however, section 1.2 gives a list of which version corresponds to which vehicle model. In exceptional cases, though, this list may not reflect the actual situation!

1.2 List of versions

This documentation is applicable to vehicles in the G series (with DAF 95 cab) and in the M series (with DAF 85 cab), built between 1991 and 1998.



G-series (10x8)



M-series (8x4)

From 1986 to 1992 vehicles with HPVS were built with an electronics unit as illustrated below. The unit is mounted against the rear wall of the cab.



“Old” unit

This documentation is not applicable to vehicles on which this “old” unit is fitted.

The documentation does however apply to vehicles built in 1991-1998 that are fitted with the “e3” Electronic Control Unit (ECU), illustrated below, with **three** blue blocks with set screws under the cover.



e3 ECU

This ECU is located under the co-driver’s seat or in the fuse box in the dashboard on the co-driver’s side.

Once it has been ascertained that an e3 ECU is fitted, it is important to find out which hydraulics version the vehicle has. We have the following variants:

- v3/3: HPVS suspension with 2 or 3 axles, 1 of which is a lifting axle. The lifting axle can be raised irrespective of the weight of the axle load.
- v6/0: HPVS suspension with 2 axles without lifting axle.

Vehicle models with a “-S” in the type designation are fitted with both HPVS and EVS.

The following table shows which hydraulics version corresponds to which vehicle model.

Vehicle model	Vehicle configuration	ECU version	Hydraulics version
G 3233-S	6x4	e3	v 6/0
G 3333-S / G 3335-S	6x6	e3	v 6/0
G 4243-S	8x4	e3	v 6/0
G 4443-S / G 4446-S	8x8	e3	v 6/0
G 5247 / G 5250	10x4	e3	v 3/3
G 5447 / G 5450	10x8	e3	v 3/3
G 5450-S	10x8	e3	v 3/3
M 3233-S	6x4	e3	v 6/0
M 3333-S / M 3335-S	6x6	e3	v 6/0
M 4243-S	8x4	e3	v 6/0

Chapter 2

Power supply

The power is supplied by a hydraulic pump unit. This unit is driven by the vehicle's engine and supplies power for the HPVS and also for the EVS, if fitted.

The pump unit consists of a controlled axial plunger pump driven by a V-belt, a separate HPVS/EVS oil reservoir, a pressure filter and a manifold block with, among other things, a bypass valve (SP12).

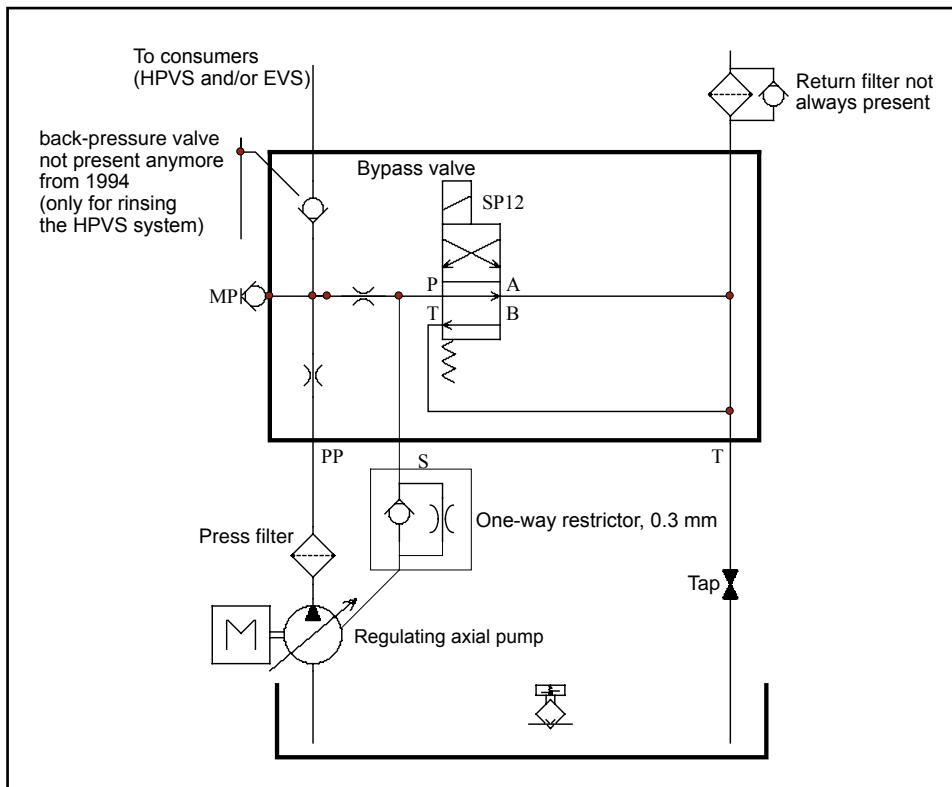

Pump-unit

The axial plunger pump has a combined pressure and flow regulator so as to provide a constant flow above a certain speed, irrespective of the engine speed. Depending on the set maximum flow, the flow will then remain constant above a certain speed (500 rpm is approx. 9 l/min).

The maximum pressure can be set by means of the bottom set screw. This pressure will be achieved when the pump is 'switched on' while the oil cannot escape (e.g. when the spring cylinders have been slid out to the maximum distance while the highest position is still being operated).

The maximum flow can be set by means of the upper adjusting screw (within certain limits). This is done as follows: Internally, at the pressure output of the pump, a branch (A) has been made to the regulator and the pump pressure in the regulator is applied to the left-hand side of control plungers. Outside the pump two throttles are placed in the main flow. Depending on

connected to A. This means that the oil can return to the reservoir via the throttle in the branch to SP12.

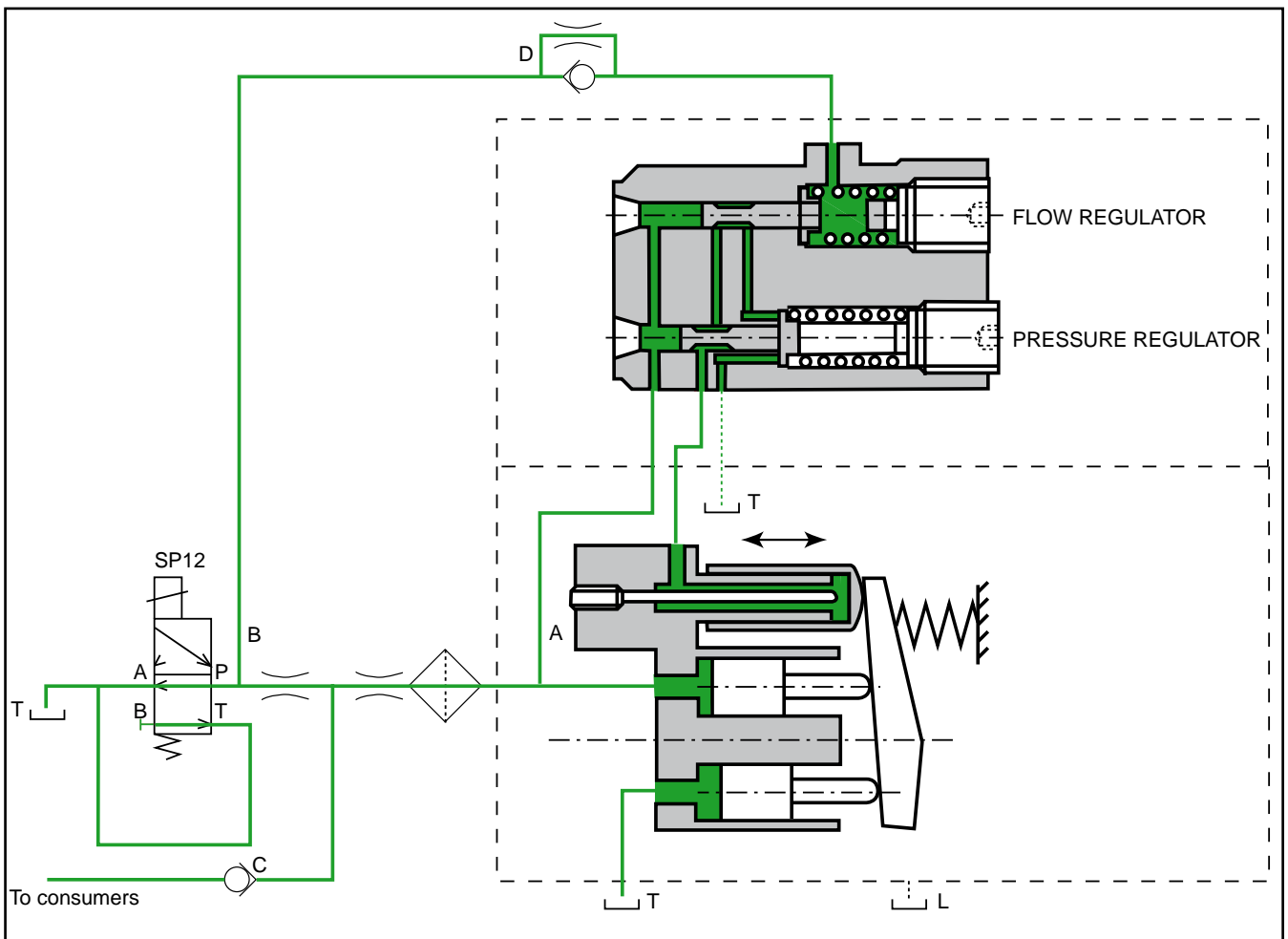

Pump control; SP12 not energised

A non-return valve (C) can be placed in the oil flow to the consumers. The purpose of this is to rinse the system and ensure that no oil from the rinsing system can be forced back to the reservoir.

Throttle non-return valve (D) (used since 1996) in the activation lead to the flow regulator ensures that when SP12 is deactivated the pressure in the regulator is not decreased too rapidly, so that the control plunger comes up hard against its stop. This can result in damage, so that the regulator may jam.

The pressure filter is fitted between the pump and the main throttle. This means that all the oil delivered by the pump will always be filtered, so that optimal oil cleanliness and hence also the service life of all hydraulic components are assured.

The filter also functions as a throttle. If the filter is clean the pressure drop will be small and will therefore have virtually no effect on the maximum flow. When the filter gets full, the pressure drop across the filter will be such that even at a much lower flow it will be equal to the set control pressure. As a consequence, the pump will deliver much less oil. The result of this may be, for instance, that the lifting axle rises more slowly or (with EVS) the axle steers more slowly.

Chapter 3

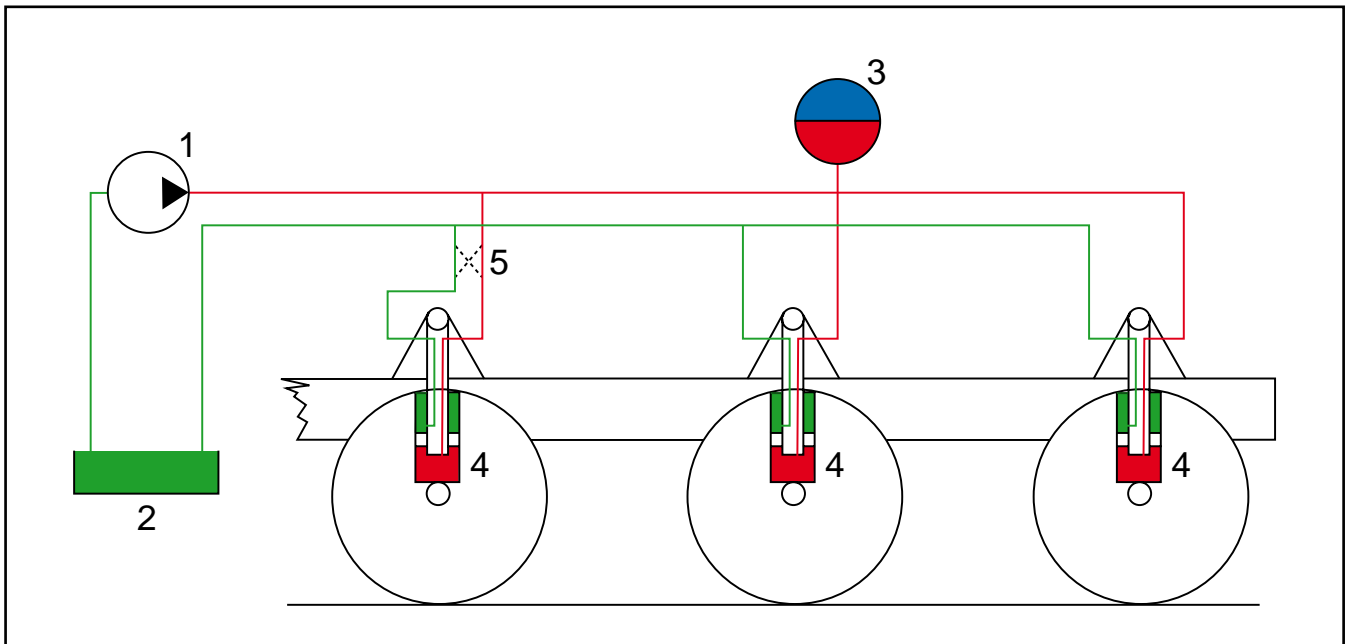
HPVS**3.1 Description**

HPVS circuit diagram

The hydraulic spring cylinders (4) form the connection between the axle and the chassis. However, the spring cylinders are not responsible for the suspension. The system is kept at the correct pressure by a pump (1), which is mounted separately and is driven by the engine. The system has a separate oil reservoir (2). A spring accumulator (3) is also mounted on each side of the vehicle.

The spring cylinders (4) on the right and left of the vehicle are hydraulically separated. The chassis weight brings about a certain oil pressure (red) via the piston rod and piston. Since all cylinders are connected to one another in the longitudinal direction of the vehicle, the pressure in each cylinder will be the same. If all cylinders have the same diameter, the axle pressures will also be the same (compensation). On some vehicles spring cylinders with a smaller diameter are mounted on one axle so as to create a lower axle pressure on that axle.

The deployment of hydraulics enables a variety of circuits to be used on the basic system. For example, an axle can easily be raised by reversing the oil flow of that axle's cylinders (5). The oil under the piston is then depressurised and the oil pressure on the rod side increases, so that the axle is raised..

3.1.1 Suspension

The spring accumulator (3) is a steel cylinder with a piston. On one side of the piston there is nitrogen, which is at a specified initial pressure. On the other side there is the

oil, which is connected to the oil in the spring cylinders. When an axle is compressed, the oil on the piston side of the spring cylinders will be forced out. This causes an increase in pressure, so that the nitrogen is compressed via the piston of the spring accumulator. This means that the nitrogen is the spring element.

3.1.2 Damping

Thanks to the correct dimensioning of the cylinders and pipes, damping is normally built in to such an extent that additional shock absorbers are not needed. Only in special cases are extra damping valves used in the HPVS system, but never separate shock absorbers.

3.1.3 Stabilisation

The HPVS system itself provides so much stability that no extra stabiliser rods are necessary.

3.1.4 Height control

A vehicle with HPVS has as standard an automatic height control system. While driving, the system automatically adopts a standard driving height. On each side of the vehicle there is an HPVS cylinder with proximity switches (see figure). These switches emit a signal when the cylinder approaches the switch. The switches are fitted on the protective sleeve of the cylinder, with a height difference of 5 mm. If the vehicle drops below the standard driving height (for instance as a result of an internal leak), the cylinder will approach the top switch. The ECU receives this signal and ensures that the pump is activated and the height (on the correct side) is adjusted. As soon as the cylinder has passed the top switch, the pump will stop again.

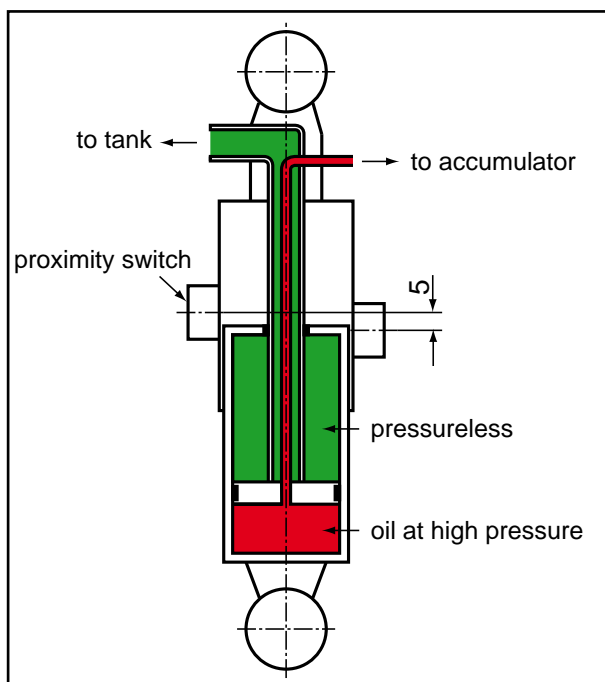

Spring cylinder circuit diagram

As an option, the height control system can be extended by the addition of a container lifting system. This system facilitates lifting and lowering containers. Since in this process the rear of the chassis drops to a few centimetres above the rear axle, the height by which the container has to be moved is reduced. The chassis is placed at an angle during this procedure. The system ensures that the axle load is evenly distributed over the rear axles.

For a detailed description of the operation of these systems, see section 3.3.

3.1.5 Lateral control

If additional stability is required (for example when tipping) a hydraulic lateral stabilisation system can be added as an option. The hydraulic lateral stabilisation system ensures that when the vehicle is stationary the oil on the rod side of the cylinders can no longer escape. The outgoing stroke of the cylinders is then blocked, but compression is still possible. This brings about a considerable increase in stability in the lateral direction.

Another popular option is the lateral levelling control system. The purpose of this control system is primarily to make tipping safer. To compensate for the chassis falling away at an angle near the rear axles, it can (where possible) be levelled in the lateral direction.

For a detailed description of the operation of these systems, see section 3.3.

3.2 Components

The HPVS suspension system consists of the following basic components:

- spring cylinders (connection between axle and chassis)
- hydraulic hoses and pipes
- test nipples
- nitrogen accumulators
- hydraulic pump unit
- one or more manifold valve blocks with hydraulic valves, pressure switches, safety devices, test connections, etc.
- various filters (pressure, return, aeration)
- oil
- electronic control unit (ECU), incl. wiring
- various sensors
- software, incl. diagnostics

3.2.1 Spring cylinders

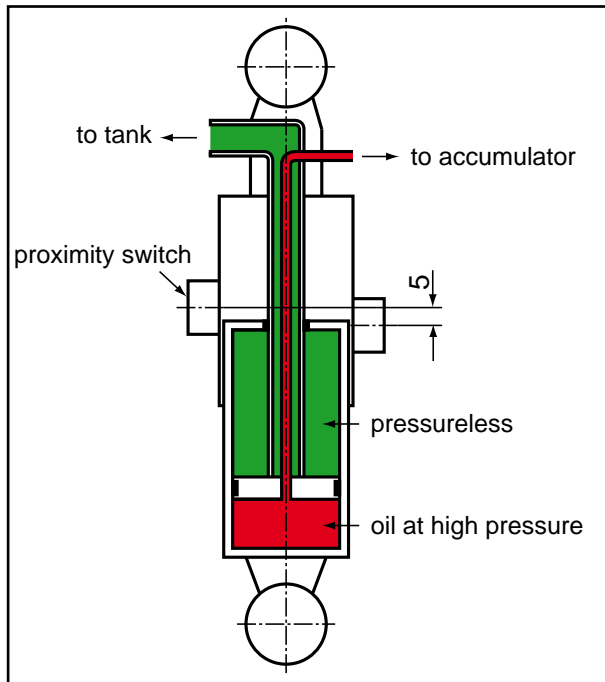

Spring cylinder

There are various types of spring cylinder. Internally they consist of largely the same components, viz.:

- ball joint at top and bottom, including fastening
- cylinder tube
- piston, including guide rings and seals
- piston rod
- rod guide, including guide rings, seal and scraper
- connection block for feeding and draining the hydraulic oil and guide to prevent the cylinder from turning
- protective sleeve

Within the cylinder family a number of variants are available, depending on hydraulics variant, vehicle type and application:

Stroke length: 180 / 259 / 359 mm (reduced / standard / enlarged stroke)

Piston diameter: 65 / 80 mm (65 : 80 mm = ratio of 7.5 tons :11.5 tons)

Protective sleeve: with / without proximity switches (2 per cyl. = height control, 1 per cyl. = lifting axle or container lifting system, no switch = control on other cylinder).

The drawing shows that the cylinder is designed to be dual-operating. This is necessary for the spring cylinders of a lifting axle. As a result, the chamber marked as depressurised in the drawing is pressurised, while the chamber under the piston

is connected to the reservoir. For the other cylinders, however, dual operation is not necessary, as these axles cannot be and do not need to be raised.

The reasons why the cylinders are nevertheless designed to be dual-operating are:

- 1 If oil leaks out past the piston seal, it is led back to the oil reservoir, so that no oil will leak to the outside.
- 2 Because the cylinders are designed in this way they are identical except for the cylinder tube and rod, making production more economical.
- 3 It makes lateral stabilisation possible.

3.2.2 Hoses and pipes

All pipes, hoses and couplings are dimensioned in such a way that leaks and/or fractures will not occur under normal circumstances. Should this nevertheless happen, a check must be made to find the cause so as to prevent further problems. The vehicle can suffer serious damage as a result of this!

Fractures or excessive leakage may have several causes. Examples include:

- extreme operating conditions (e.g. driving at high speed over heavy terrain or when heavily overloaded)
- poor/insufficient maintenance

3.2.3 Test nipples

There are a number of test nipples on the manifold block for checking the operation of the hydraulic system.

These test nipples are of the Minimes type, vers. 400, with a test connection with an M16x1.5 external screw thread.

The function of the various measuring points will be discussed in greater detail where necessary.

3.2.4 Accumulators

With HPVS, hydraulic spring accumulators are used for the suspension.

A spring accumulator is a steel cylinder with a piston. On one side of the piston there is nitrogen, which is at a specified initial pressure. On the other side there is the oil, which is connected to the oil in the spring cylinders. When an axle is compressed, the oil on the piston side of the spring cylinders will be forced out. This causes an increase in pressure, so that the nitrogen is compressed via the piston of the spring accumulator. This means that the nitrogen is the spring element.

One accumulator is mounted on each side of the vehicle. The initial pressure of the nitrogen can be displayed via the diagnostics cabinet (see Chapter 9 - Technical data). If in doubt, enquire at GINAF Trucks bv.

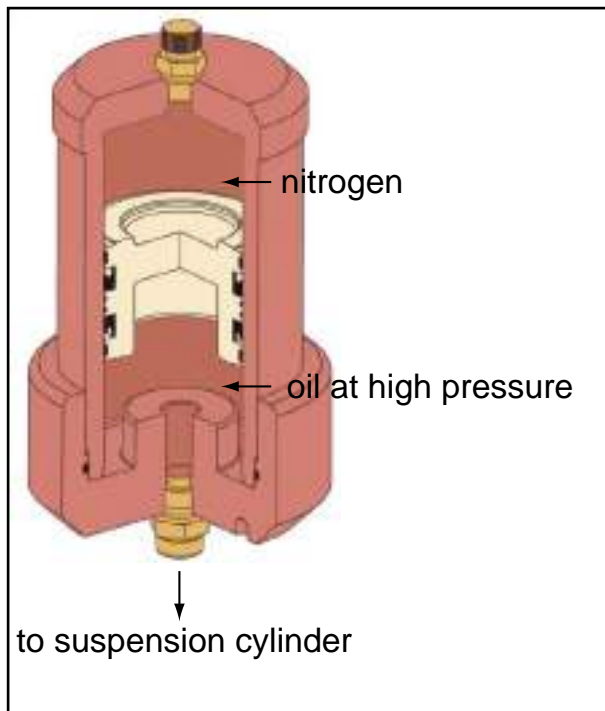

Spring accumulator

Operation of the suspension:

If the oil pressure is lower than the nitrogen pressure, the piston will touch the bottom of the accumulator (the side to which the oil pressure is connected). As long as the oil pressure is below the nitrogen initial pressure the piston will not move and the vehicle will not have any suspension. Normally this situation does not occur, because the nitrogen pressure is approx. 10-15 bar, whereas the oil pressure is always approx. 5 bar above this when unladen. This situation can only arise if for example the initial pressure of the spring accumulators is too high or if the vehicle is in the lowest position. The nitrogen initial pressure is always checked when the piston is on the bottom, i.e. with the vehicle in the lowest position.

If the oil pressure is greater than the nitrogen pressure, the piston is forced away from the bottom of the accumulator, thereby compressing the nitrogen. This produces the actual suspension.

The suspension that then arises is highly progressive. At low pressures, e.g. when the vehicle is unladen (oil pressure approx. 15 bar), a pressure increase of 15 bar (i.e. 100%) will mean that the gas will decrease to 50% of the original volume. This makes for soft suspension.

With a vehicle laden to the maximum (oil pressure approx. 120 bar), a pressure increase of 15 bar represents a rise of only 11%. This means that the nitrogen will only be compressed a little, making for rigid suspension behaviour.

This means: unladen vehicle - soft suspension behaviour with large spring travels
 laden vehicle - rigid suspension behaviour with small spring travels.

This makes for a comfortable suspension that allows little rolling of the vehicle when

fully laden, so that excellent vehicle stability is obtained.

3.2.5 Hydraulic pump-unit

The power is supplied by a hydraulic pump unit. This unit is driven by the vehicle's engine and supplies power for the HPVS and also for the EVS (if fitted).

The pump unit consists of a controlled axial plunger pump driven by a V-belt, a separate HPVS/EVS oil reservoir, a pressure filter and a manifold block with, among other things, a bypass valve.

3.2.6 Filtering

Possibly the most important component in a hydraulic system is the filter. A general characteristic of hydraulics is reasonably problem-free operation and long service life as *long as there is no dirt in the system*.

The greatest care must therefore always be taken when working on the hydraulic system, since any dirt that gets into the system causes a very high degree of wear! Remember that such wear can be caused by dirt that is invisible to the naked eye (0.01 mm!!).

Since in practice this can never be entirely avoided and wear in the system itself also causes dirt, very fine filtering has been opted for with the HPVS. The system contains several filters, designed to remove any dirt that enters or is already there.

Filters:

- aeration filter: MANN paper filter element, not washable or - if integrated in filler cap - washable to a limited extent
- filler filter in reservoir: gauze filter, washable
- pressure filter: replaceable element
- return filter: replaceable element (if fitted)

When the pressure filter starts to get full, its position will cause the output in the pump control circuit (see Chapter 2) to decline, which could give rise to malfunctions. With lifting axles, for instance, the axle may rise only slowly and in some cases it may even not rise to its maximum lift.

If this happens, the pressure filter element must be replaced (older vehicles sometimes have an indicator, possibly with a lamp, but because problems usually occurred before this lamp came on this was discontinued).

3.2.7 Oil

Bear in mind the following points when oil needs to be added:

- Only add oil using a carefully cleaned funnel and a filter (e.g. a paint filter) or filtered oil.

- Use the correct type of oil (2 possible base oils!): see Chapter 9.
- The reason for topping up. The hydraulic system must be externally leak-free, so check for external leakage.

3.2.8 ALR (hydraulic control)



Hydraulically controlled ALR

A hydraulically controlled load-dependent brake control system (ALR) is fitted on vehicles with HPVS. A normal ALR controlled by the compression cannot be used because HPVS includes an automatic height control system. As a result, a constant driving height will be obtained irrespective of the vehicle's load, so that an ALR controlled by compression will not register any load difference and will thus not make any adjustment.

For the hydraulically controlled ALR a Wabco ALR is used, which is normally meant for air-sprung vehicles. Since in this case the control has to be provided by the hydraulic cylinder pressure rather than the pneumatic pressure from air bellows, the air cylinder that is normally mounted on the ALR was replaced by a small hydraulic cylinder.

Note: near the activation lead (diameter 10 mm) a throttle is mounted in the connection nipple on the ALR cylinder (this is to prevent damage caused by pressure surges).

3.3 Operation

3.3.1 Height control

The height control system for the rear of a vehicle with HPVS is split into two identical systems that operate independently of one another on the left and right.

Height control valves::

4/3 control slide with 2-sided magnet energisation and spring-loaded positioning in the centre position + pressure-controlled non-return valve + throttle.

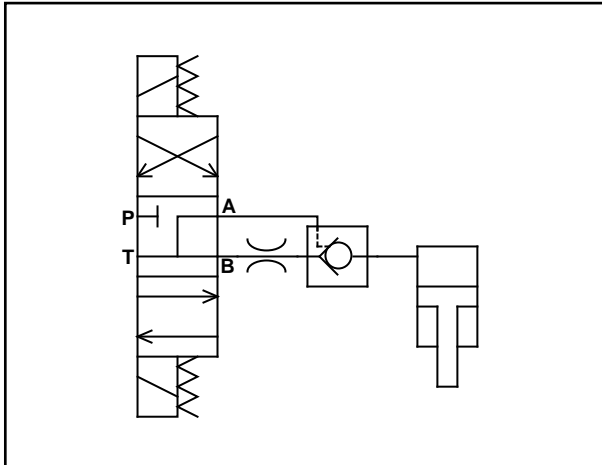

4/3 valve with throttle, controlled non-return valve and spring cylinder

Switching positions:

- No voltage on either magnet:
Valve in centre position due to spring-loaded return. No adjustment.
- Voltage on magnet on 'cross side':
Valve in switched state. Cross mode activated. Inflating (extra oil to the relevant side).
- Voltage on magnet on 'parallel side':
Valve in switched state. Parallel mode activated. Draining (oil from the respective side to the reservoir).

The vehicle's height control system operates completely independently on each side and is activated by the proximity switches on the cylinders (both height control system and container lifting system) or by the lateral levelling control system (if fitted).

With the cross mode activated (inflating), oil will flow from the pump via P to B and will then be fed to the cylinders on one side via the controlled non-return valve.

With both magnets unenergised, the valve will be in rest state = centre position. In this position ports A, B and T are interconnected, while P is separated from the others. The pressure-controlled non-return valve (virtually leak-free) prevents the oil from ever going back from the cylinders to the control side of the height control system. The A port is also connected to T so as to make absolutely certain that no pressure is applied to A when the height control slide is not energised. Otherwise, due to leakage from P to A when the pump has to deliver pressure for another function, the controlled non-return valve would be opened, allowing oil to flow out from B to T.

When the parallel mode is activated (draining), oil will drain from the cylinders via B to T, after which it will flow back to the reservoir. The pressure-controlled non-return valve will now be opened because the pump pressure is on port A.

The pump is activated, so that pressure can be built up.

To understand the operation properly, a basic characteristic of the control slides used is necessary:

CONTROL SLIDES ARE NEVER INTERNALLY LEAK-FREE

This means that oil from a port with a higher pressure will always flow to a port with a lower pressure.

This explains why even when the height control system is not activated (for instance at speeds below 5 km/h), a change can still be made in the height of the vehicle. This is because the pressures on the various ports are different. These differences are highly dependent on the load condition of the vehicle.

For example: at a pressure on port P of 190 bar (pump activated), the pressure on A(=B=T) is 20-25 bar.

When P has a pressure greater than the pressure of B and A, oil will leak internally from P to B and from P to A. However, since they are connected to the T port, this oil will be led directly back to the reservoir. Due to the construction of the control slides, no oil can leak directly from P to T, but it will go via A and via B.

Conclusion: when the pump delivers pressure for a purpose other than the height control of the side that is already at the correct height, a small amount of oil will always leak past the plunger. As a result, the available oil flow for certain purposes will not be entirely the same as the pump output. However, the differences will scarcely be noticeable as long as no excessive wear to the control slides has occurred.

It should also be mentioned that if the pressure in B exceeds that in P (which can happen with very heavy loads) no oil can flow back from B to P (P=190 bar = 20 tons per axle!).

These pressures can occur, for example, in off-road situations (raised lifting axle $v3/3$) or when the lateral levelling control system is activated, since then almost all the load often rests on one side, so that the entire tonnage is on only 2 or 3 cylinders.

The throttle used with the height control valves ensures that inflation and draining are carried out smoothly. Particularly when the pressure differences between P and B are large (P high and B low + inflation activated) or there is a high pressure on B and T=0 bar and then draining is activated, without any throttle this makes for a jerky result, since the valves provide very little resistance (approx. 10 bar at 60 l/min).

3.3.2 Hydraulic lateral stabilisation

Lateral stabilisation can also be provided as an extra on all vehicles with HPVS.

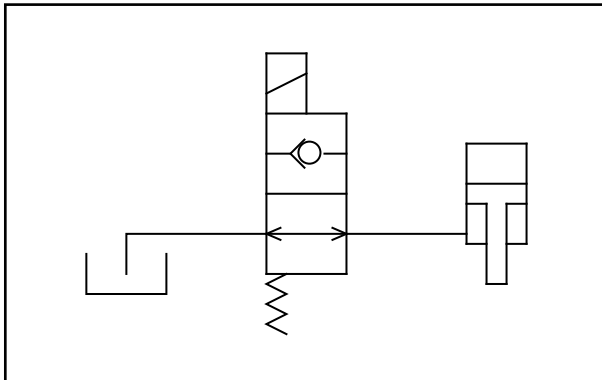

2/2 valve with spring cylinder, normally open (lateral stabilisation)

Switching positions:

- No voltage on magnet:
Valve open on two sides. Lateral stabilisation deactivated.
- Voltage on magnet:
Valve open on one side. Rod side spring cylinders hydraulically locked. Lateral stabilisation activated.

Lateral stabilisation is automatically activated at vehicle speeds of less than 5 km/h.

If the valves are open on two sides (lateral stabilisation deactivated), the oil can flow freely from the reservoir to the rod side of the HPVS cylinder(s) and back. When the valves are open on one side (lateral stabilisation activated), oil can only flow from the reservoir to the rod side of the HPVS cylinders, but cannot now flow the other way.

It is therefore now possible to pull the HPVS cylinders, so that a very roll-stiff vehicle is obtained. The vehicle will now be given a tilt line around the tyres (approx. 2-2.5 m) instead of around the HPVS cylinders (approx. 0.95 m).

Compensation between HPVS cylinders (rod side) on each side simply continues to be possible. The spring cylinders can also still compress. A vacuum is then created on the rod side.

This system is of particular interest for vehicles with a tipper bed, since stability is greatly enhanced during tipping.

3.3.3 Hydraulic lateral stabilisation: superstab

Lateral stabilisation in the “superstab” version can also be provided as an extra on all vehicles with HPVS. The system works largely in the same way as the hydraulic lateral stabilisation system, except that the valves work conversely.

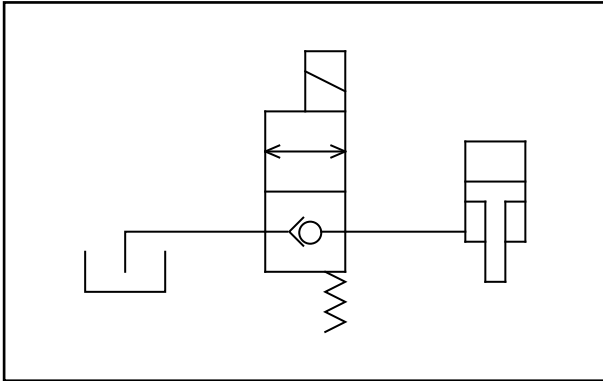

2/2 valve with spring cylinder, normally closed (superstab)

Switching positions:

- No voltage on magnet:
Valve open on one side. Rod side spring cylinders hydraulically locked. Superstab activated.
- Voltage on magnet:
Valve open on two sides. Superstab deactivated.

Superstab is automatically activated if a certain turning radius and vehicle speed occur.

If the valves are open on two sides (superstab deactivated), the oil can flow freely from the reservoir to the rod side of the HPVS cylinder(s) and back. When the valves are open on one side (superstab activated), oil can only flow from the reservoir to the rod side of the HPVS cylinders, but cannot now flow the other way.

It is therefore again possible to pull the HPVS cylinders, so that a very roll-stiff vehicle is obtained, as with lateral stabilisation.

This system is of particular interest for vehicles with a high centre of gravity or moving load (such as liquid), since cornering stability is greatly improved.

3.3.4 Lateral levelling control

Lateral levelling control can also be provided as an extra on all vehicles with HPVS. When the lateral levelling control system is activated, the normal height control system is deactivated. The vehicle is then levelled in the lateral direction from the levelling unit (fitted under the rear chassis cross member).

During adjustment the ECU instructs the height control valve on the side that is too high to drain and at the same time instructs the height control valve on the side that is too low to inflate. As long as the vehicle is at an angle, a yellow warning lamp on the dashboard will light up, showing R or L, meaning that the right-hand or left-hand side is too low. As long as one of these lamps is on, the switch must be held. When they are both off the vehicle is level.

3.3.5 Container lifting system

This system facilitates lifting and lowering containers.

Since the rear of the chassis drops to a few centimetres above the rear axle, the height by which the container has to be moved is reduced. The chassis is placed at an angle during this procedure.

If the vehicle is put in the very lowest position while a container is being lifted or lowered, the rear axle rests fully against the chassis. This means there is no more compensation, so that this axle has to bear the full weight, which is not desirable.

When the container lifting system is being used, compensation remains possible, i.e. the axle load remains evenly distributed over the rear axles.

3.3.6 Lifting axle (v3/3)

Purpose of the lifting axle:

- 1 To improve the vehicle's off-road capability. By raising the axle, the axle pressure on the other axles is increased, so that a greater driving power can be transmitted by the driven axles. This also eliminates unnecessary resistance from the non-driven wheels.
- 2 To reduce tyre wear (on an unladen vehicle).

In order to provide optimal off-road performance when driving with a raised axle, the axle is first uncoupled hydraulically from the other axles before being raised. This is done for each side of the vehicle, independently of one another. After the uncoupling procedure the actual raising operation is carried out. The instruction to do this comes from a 4/2 valve (the centre valve in the manifold block).

Uncoupling:

The uncoupling operation is carried out by means of the outer valves on the manifold block, consisting on each side of a 3/2 valve, a controlled non-return valve and an ordinary non-return valve.

Switching positions:

- No voltage on the magnet:
Coupling the axle. Valve in rest state by means of spring loading. Connection between lifting axle cylinder and non-lifting axle cylinders via controlled non-return valve and via the P-B connection by way of the non-return valve cartridge in the 3/2 valve.

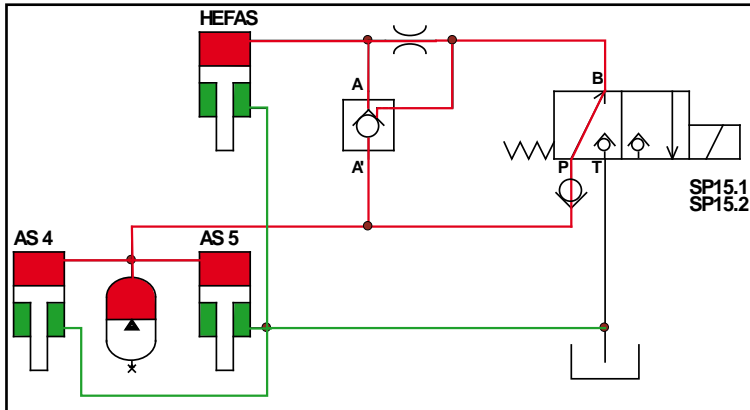

- Voltage on the magnet:
Valve in switched state. Lifting axle cylinder uncoupled from the other cylinders because the controlled non-return valve closes and the oil on the piston side of the lifting axle cylinder is depressurised via B-T.

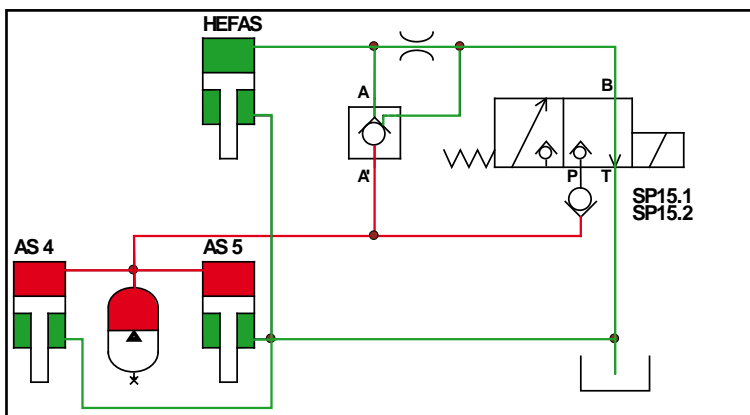

The throttle ensures that the controlled non-return valve closes properly. This is because the activation is on the side of the 3/2 valve connected to the reservoir. Since the rod side of the lifting axle cylinders is pressurised during the actual raising operation, without any throttle the oil from the piston side would not be entirely pressureless when the controlled non-return valve was activated. This non-return valve might then not close properly, so that the oil from other spring cylinders could also drain to the reservoir.

When the lifting axle is uncoupled from the other axles, the oil on the piston side of the lifting axle's spring cylinder is pressureless. This means that the axle is still on the ground, but there is no more axle pressure. The next step is that the axle is raised.

Raising:

The raising operation is done by means of a 4/2 valve (this is the centre valve on the manifold block), together with a non-return valve and a throttle.

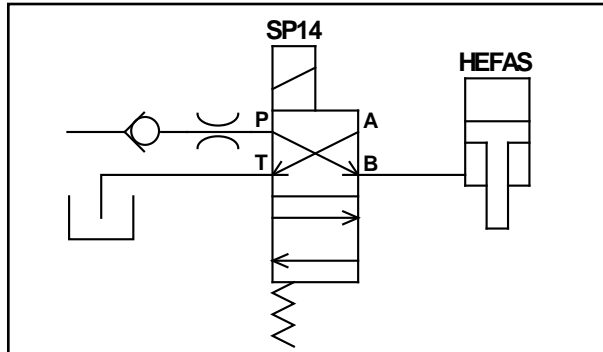

Raising the axle

Coil SP14 is operated. This connects P to B, so that pressure is built up from the pump on the rod side of the lifting axle's cylinders. This raises the axle. This works one way only because of the non-return valve (provided the pump pressure is less than the pressure on the rod side of the lifting axle's cylinders). This may happen, say, when the height control system is adjusting the height with an unladen vehicle. Port A is connected to the piston side of the lifting axle cylinder via the uncoupling valve, so the oil on the piston side of the cylinder can flow back to the reservoir during the lifting operation.

The pump will be activated for approx. 20 seconds after the lifting axle switch is activated in order to try to raise the axle. This will then be repeated every 6-13 minutes. SP14 will continue to be operated.

Lowering:

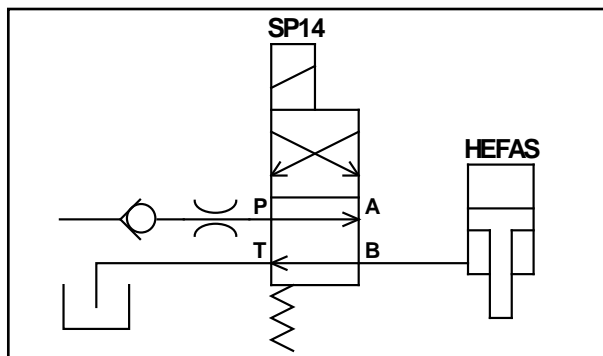

Lowering the axle

Magnet coil SP14 is no longer energised, so that the valve returns to the neutral position. The pump is connected to A via P, while B is connected to the reservoir via T. This means that oil is fed to the piston side of the lifting axle's cylinders via the uncoupling valves. At the same time, oil from the rod side of the lifting axle's cylinders is depressurised because it can drain away to T via B and thence to the reservoir: the lifting axle is lowered. Since the lifting axle falls faster than the pump can feed oil, due to its own weight, during the lowering operation no pressure will yet be built up in the lifting

axle's cylinders. Only when the axle is on the ground and the cylinders are completely filled will there be any build-up of pressure. This is because the pump can now only get rid of its oil by pushing the lifting axle's cylinders out further, so that the vehicle is 'lifted up' by this axle. The cylinders are now coupled again:

The pressure on the piston side of the lifting cylinders will increase. When this pressure reaches a value of approx. 1/3 of the pressure in the non-lifting cylinders, the pressure-driven non-return valve in the uncoupling section will be opened, so that oil can flow from the non-lifting axle cylinders to the lifting axle cylinders. The pressure on both sides of the controlled non-return valve will be the same, so that the control pressure of this valve will also be the same as the pressure in the suspension system.

The controlled non-return valve is now in a state of equilibrium.

The lifting axle has now been coupled. During coupling it makes no difference whether or not the 3/2 valves are energised. This means it is not possible to have very high pressures in the lifting cylinder because the axle couples automatically. Even if the pressure builds up very quickly, as when lowering the lifting axle whilst driving, nothing can happen: the activation of the controlled non-return valve is not rapid (due to the A-B throttle), but the non-return valve can also be opened in the direction from lifting axle cylinder to non-lifting axle cylinders, so that the lifting axle can never be subjected to extreme pressures.

If the coupling occurs before the maximum time has elapsed, oil will be added to the overall suspension system via the 3/2 valves: the vehicle will be raised. The height control system will compensate for this at speeds in excess of approx. 5 km/h.

If coupling takes place electrically before the hydraulic system does it, the lifting axle will immediately be coupled to the other cylinders. This is because the 3/2 valves return to their neutral position, so that the P-B connection is made. As P is under pressure from the operating spring cylinders, oil will now go via the non-return valve cartridge to B, which is itself again connected to the activation plunger of the controlled non-return valve. This will open and make the connection between the lifting axle cylinder and other cylinders. This can only happen as a result of a wire breakage in the respective magnet coils, failure of the magnets, etc. This means that, say, tipping with a raised axle always entails a certain risk.

While driving, the P-B connection ensures that the controlled non-return valve is opened if the valve wants to close, owing to a high pressure drop across this controlled non-return valve due to very high oil flows (from non-lifting axle cylinders to the lifting axle cylinder). If in the most extreme case the valve were to close anyway, this is no problem, as the spring accumulator is mounted on the side of the non-lifting axle cylinders. This can therefore absorb the high pressures.

3.3.7 Manifold-block

The HPVS sub-systems described above are assembled in a manifold block.

3.3.8 Hydraulic diagrams

The hydraulic diagrams for v3/3 and v6 are shown on the following pages.

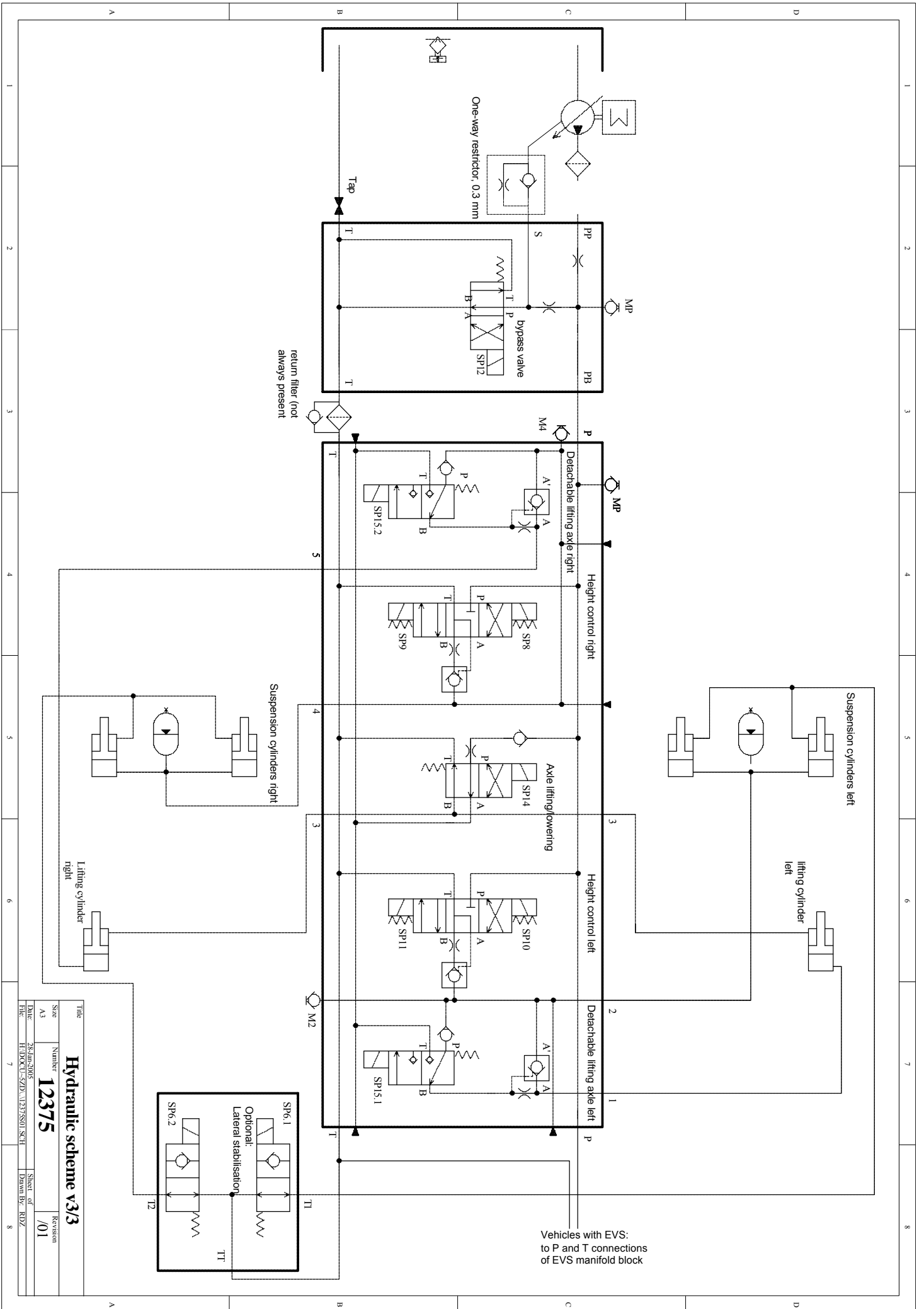

Title		Hydraulic scheme v3/3	
Size	Number	Revision	
A3	12375	/01	
Date	28.06.2005	Sheet of	
File	H:\DOCU-Z\12375\SOI_SCH	Drawn by	RJZ

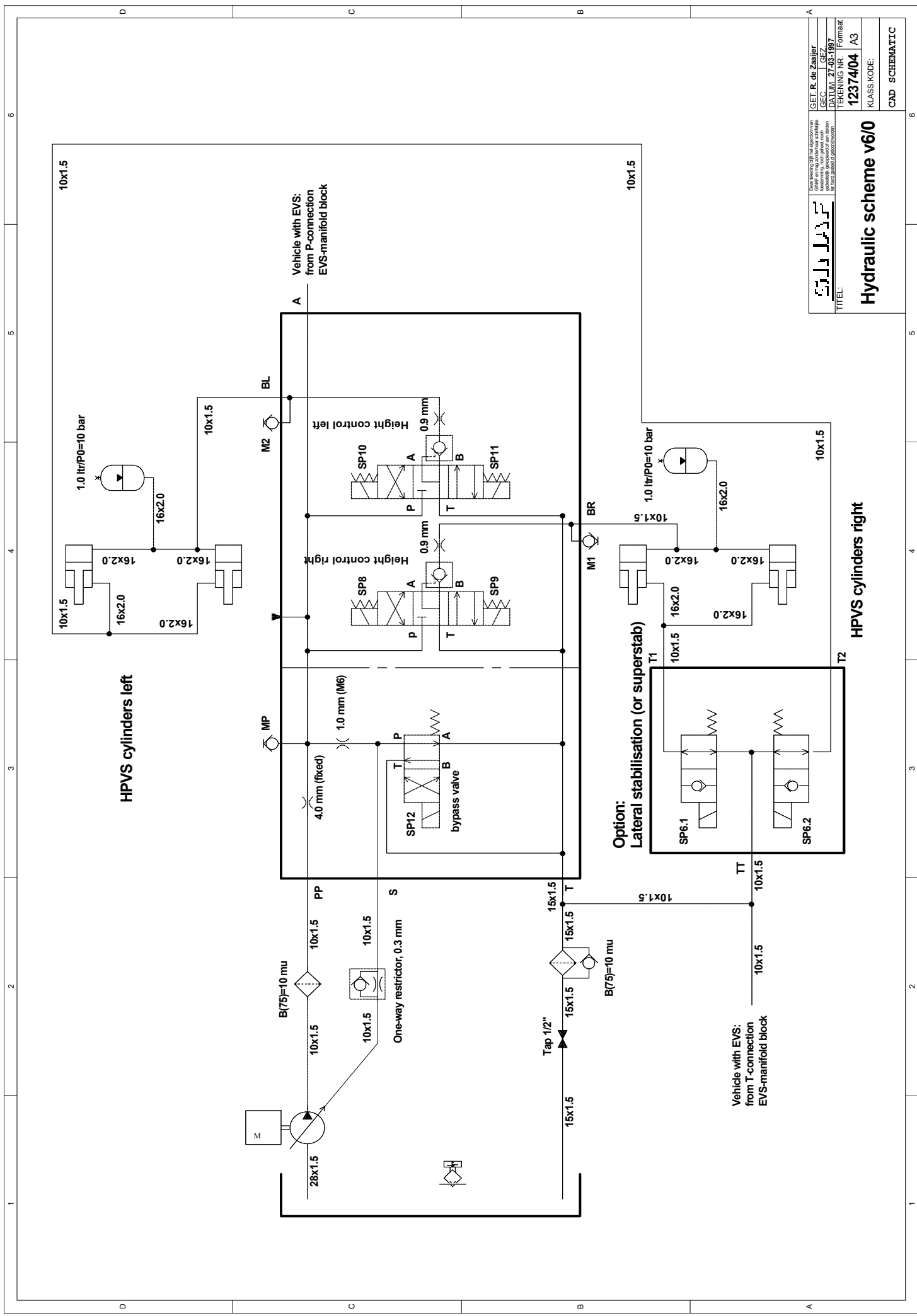

		GET. R. de Zaalijer GEC. M. 27-03-1997 TEKENING NR. 12374/04 Formaat A3 KLASSE: 12374/04 KLASSE: A3 KLASSE: A3
TITEL:		CAD SCHEMATIC

Hydraulic scheme v6/0

HPVS cylinders right

HPVS cylinders left

**Option:
Lateral stabilisation (or superstab)**

Vehicle with EVS:
from T-connection
EVS-manifold block

Vehicle with EVS:
from P-connection
EVS-manifold block

Chapter 4

EVS**4.1 General**

EVS (Electronic Vehicle Steering) is an electronically controlled, speed-dependent steering system for a rigid rear axle, driven or otherwise. This rear axle is controlled by two hydraulic cylinders.

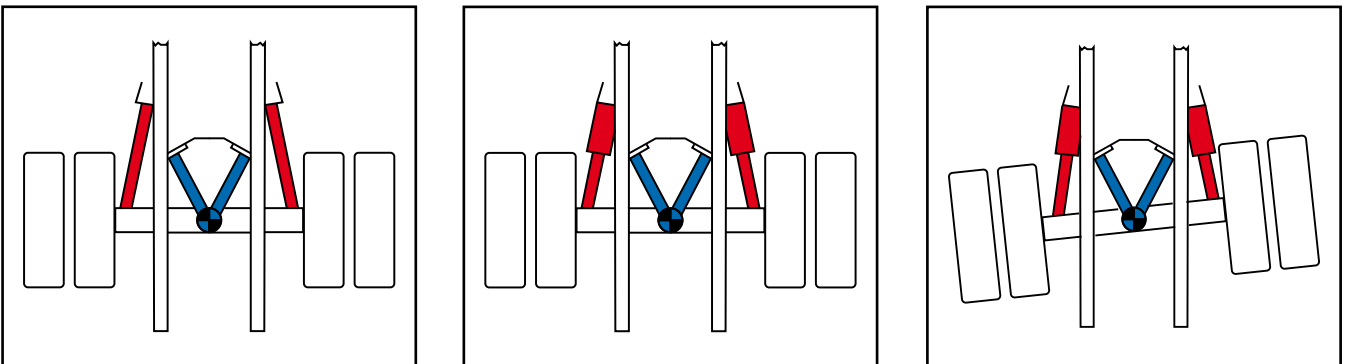

The basis for this is a standard rear axle suspension with a V-rod (blue) in the centre of the axle on top and with two torque rods (red) on the left and right underneath. With this arrangement the V-rod absorbs longitudinal and lateral forces, while the torque rods absorb only longitudinal forces. With EVS the lower torque rods are replaced by special hydraulic cylinders that give the axle a steering motion due to the change in length (one longer and the other shorter by the same amount). The axle turns about the ball of the V-rod, which is attached to the axle.

When the EVS is switched on, the rear axle steers at speeds of a maximum of approx. 25 km/h. From 25 - 45 km/h the steering angle of the rear axle is continually decreased further in respect of the steering angle of the front axle. This is called the transition speed. At 45 km/h the rear axle is hydraulically locked in the straight-ahead position. Above 45 km/h, then, the axle does not steer, which makes for improved directional stability.

The EVS can be activated and deactivated by means of a switch. With normal vehicle usage it is recommended that the switch should always be left "on". The steering of the rear axle then proceeds fully automatically. Occasionally the EVS may be deactivated. The axle then steers immediately to the centre position.

When the vehicle is started with EVS deactivated, the buzzer will sound briefly. When the EVS is reactivated, the rear axle will only start steering again after the front axle has been in the straight-ahead position.

4.2 Description of components

The EVS consists of three main parts:

- two steering cylinders (1 per side)
- drive system:
hydraulic pump, reservoir, various hydraulic valves
- steering system:
angle and length sensors, ECU, various sensors and software for steering and security

4.2.1 Steering cylinders

A steering cylinder consists of two oil circuits, assembled in a single cylinder:

- steering system
- emergency steering system or centring system

The steering system is the centre section with connections X1 and X2.

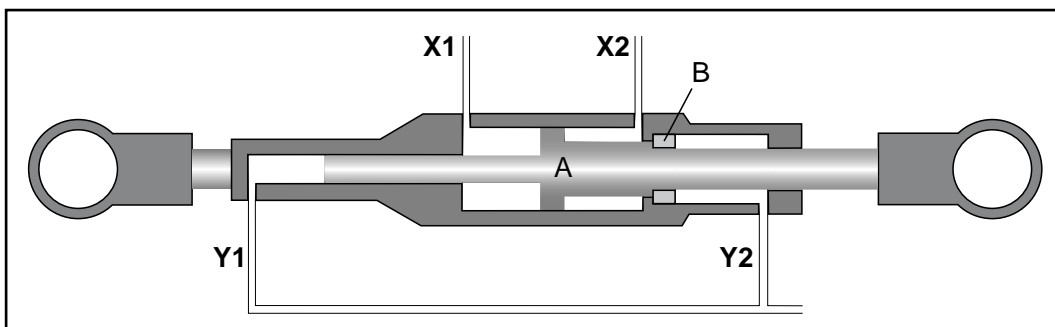

EVS cylinder

Steering system:

The steering system consists of the piston (A), which is operated via line connections X1 and X2. Connections X1 and X2 are alternately connected to the pressure line and the return line by a steering valve, depending on the required steering direction. As a result, the EVS cylinder slides in or out.

Emergency steering/centring system:

The emergency steering/centring system is connected to the emergency steering circuit via the line connection Y1/Y2. The function of the emergency steering/centring system is to return to and lock the EVS cylinder in the centre position. The emergency steering system consists of two chambers, with on one side a rod surface and on the other side a floating piston (B).

4.2.2 Emergency steering accumulator



Emergency steering accumulator

The emergency steering accumulator is a pressure vessel consisting of two parts. The two parts are separated from one another by a diaphragm. The upper part of the accumulator is filled with oil. The lower part of the accumulator is filled with nitrogen under a certain initial pressure.

If the oil pressure in the emergency steering system is higher than the nitrogen pressure in the accumulator (because oil is pressed out of the EVS cylinders while steering), oil flows to the accumulator and is stored there. This results in the diaphragm compressing the nitrogen, as a result of which the gas pressure is increased.

If the pressure in the emergency steering circuit is decreased (because the EVS cylinder has returned to the centre position), the nitrogen presses oil out of the accumulator back into the emergency steering circuit via the diaphragm.

In this way the pressure in the emergency steering circuit is maintained.

4.2.3 Sensors

To determine the front axle angle and the rear left and rear right cylinder length, angle and length sensors respectively are used in the form of high-quality potentiometers. At 1 steering motion per second these potentiometers have a service life of at least 8.5 years, based on 1600 hours/year.

Since voltage differences of as little as 0.01 V produce a change in the measured angle, only gold contacts are used in the connectors in the circuit (primarily against corrosion), while high-quality steering cable is used as the cable (with a metal braided sheath whose purpose is to combat external radiation). When replacing the cable or connectors, then, only the original GINAF parts may be used, since correct, constant

angle/length measurement is of essential importance for the steering and hence for the safety of the driver, freight and vehicle!

Position sensors: front axle angle sensor, separate or integrated in an idler arm. The sensor consists of a high-quality potentiometer (2500 ohm, a 500 ohm input resistor and a 1000 ohm output resistor). Adjustment by rotating lever with respect to axle (for separate version) or carrier (for integrated version).

The cylinder length sensors are integrated in the cylinders (not available loose), including 500 ohm input resistor and 1000 ohm output resistor. These sensors cannot be adjusted.

4.2.4 ECU

The control unit for the EVS and HPVS (or only the HPVS) is a microprocessor-controlled unit that on the basis of a computer program and input parameters ensures that EVS and HPVS valves are operated correctly.

The ECU consists of a number of main components:

- 1 Voltage converter and voltage stabiliser
- 2 Main circuit
- 3 Input circuit
- 4 Output circuit
- 5 Safety circuit
- 6 Communications circuit

4.3 Operation; EVS cylinders

4.3.1 Centre position

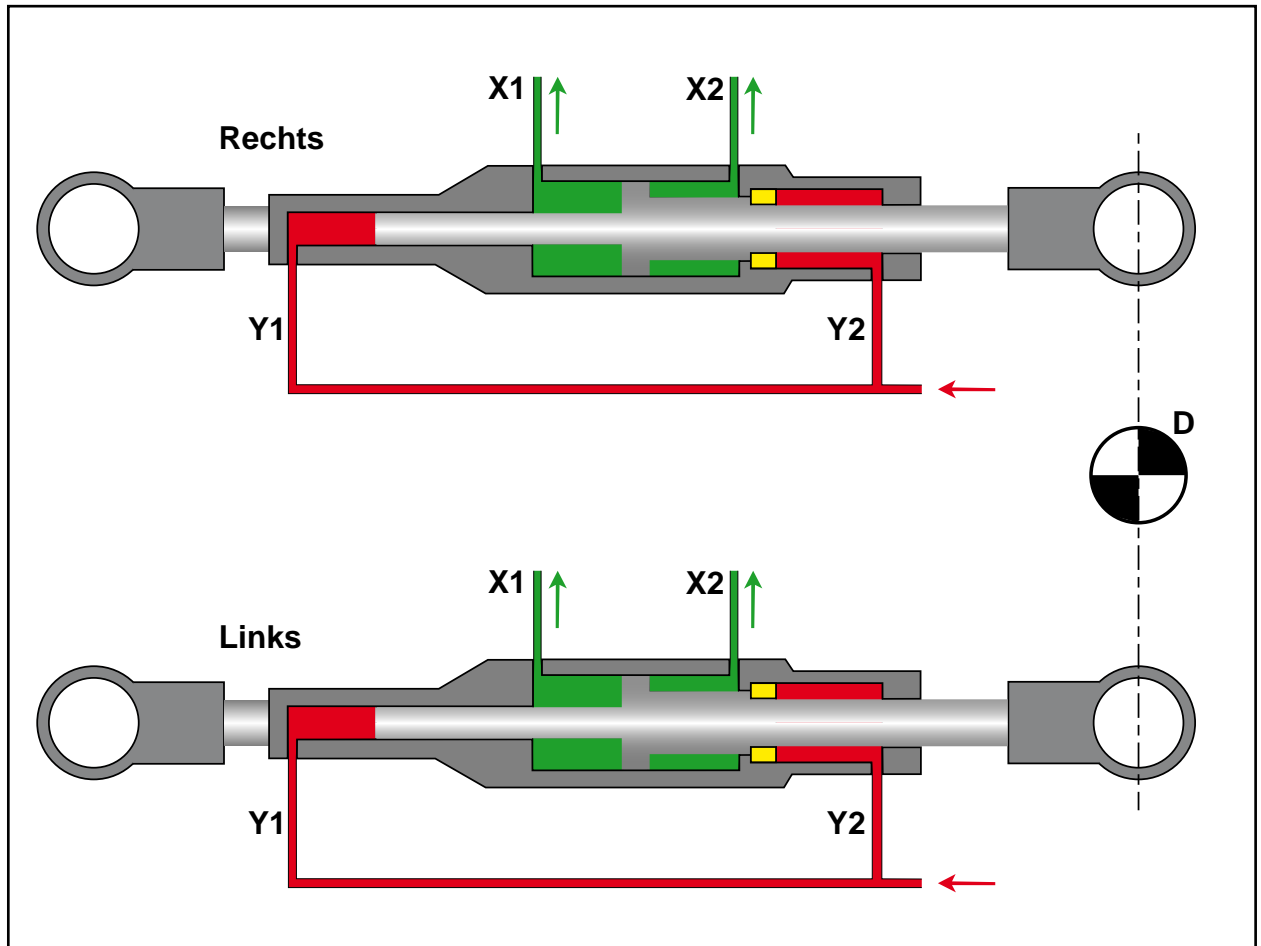

EVS; centre position

Connections X1 and X2 of both cylinders are connected to the reservoir. Connections Y1 and Y2 of both cylinders are kept under pressure by the emergency steering accumulator. This pressure is applied to the piston rod via connection Y1 and to the floating piston (shown in yellow) via Y2. Because the surface area of the floating piston is approximately twice as large as the surface area of the piston rod, the floating piston will carry the main piston to the left until the floating piston rests against the stop. At the same time, at Y1 the main piston is pushed to the right with half the force. The EVS cylinder is now fixed. This situation occurs when driving straight ahead at the transition speed or when the EVS switch on the control panel is off. When the transition speed is exceeded, i.e. the vehicle speed is higher than 45 km/h, the system will ensure that connections X1 and X2 are closed, so that the oil can no longer escape from the steering compartments. The cylinders are now subjected to dual hydraulic locking.

4.3.2 Steering left

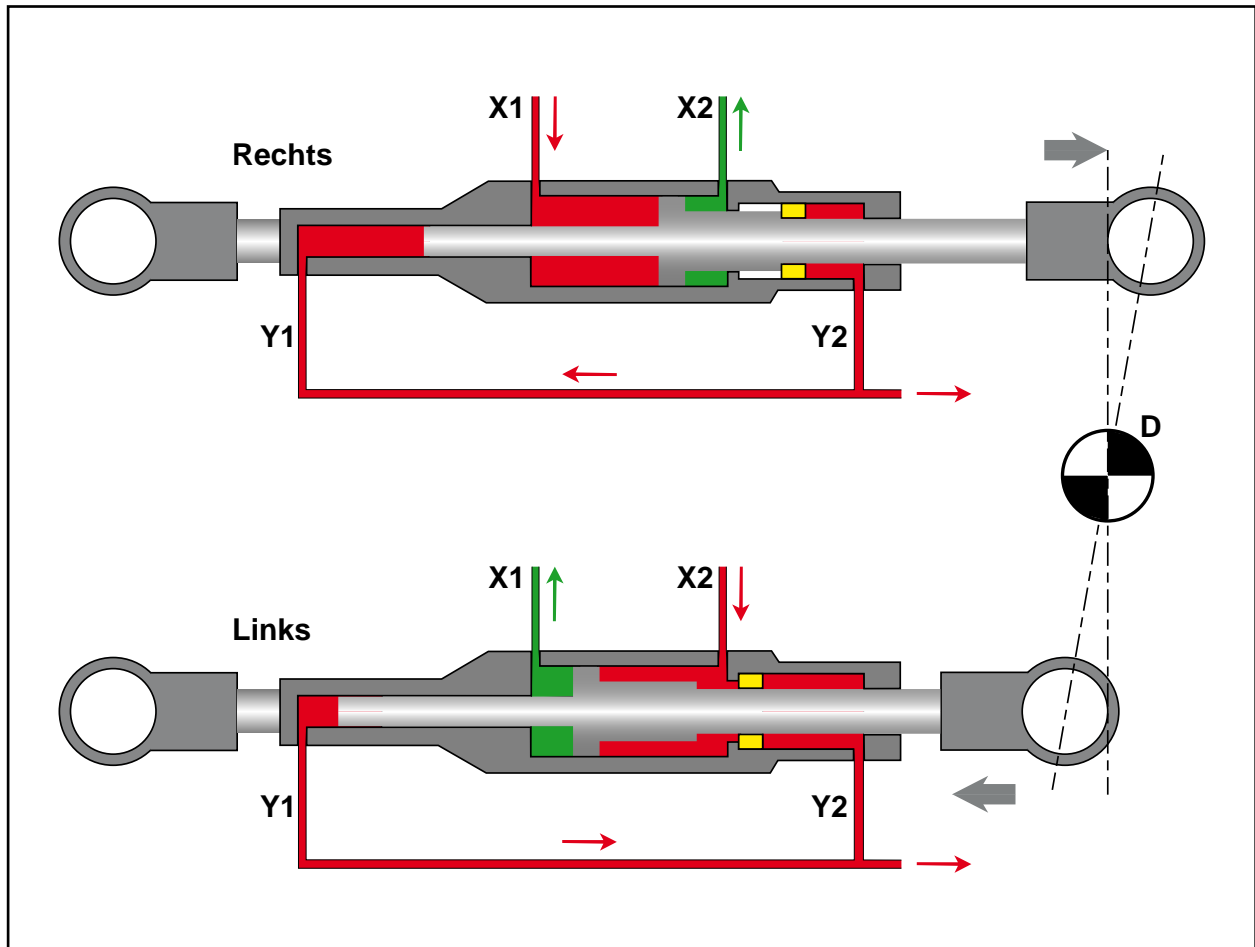

EVS; steering left

When the vehicle is steering left (the rear axle must then steer right about pivoting point D), oil is fed to connections X1 (right) and X2 (left). The oil reaches connection X1 from the right-hand EVS cylinder and will push the piston out. This forces the oil at connection X2 into the reservoir. If the vehicle is steered to the left from the centre position, the main piston will carry the floating piston to the right. The oil is forced out of emergency steering compartment Y2 and partially fills emergency steering compartment Y1. The remaining oil volume returns to the emergency steering accumulator. At the left-hand EVS cylinder the oil reaches connection X2 and the piston will slide in. This forces the oil at connection X1 into the reservoir.

The oil is forced out of emergency steering compartment Y1. Since the volume in emergency steering compartment Y2 does not change (the floating piston stays in place), all of it will flow back to the emergency steering accumulator. The difference in surface area of the main piston at the X1 and X2 side is compensated for by the difference in surface area of the main piston at Y1 and Y2 (ring surface area of floating piston).

4.3.3 Steering right

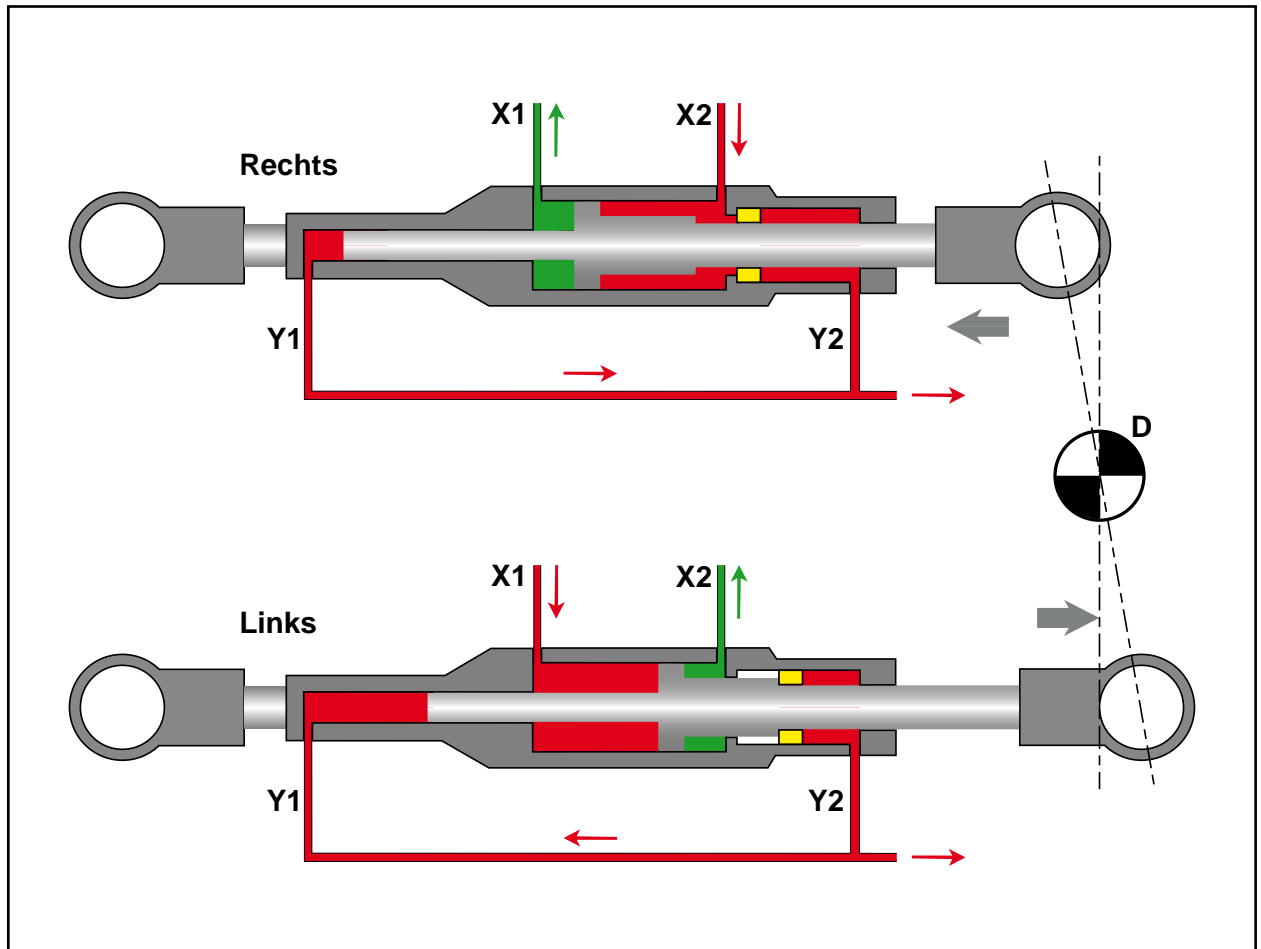

EVS; steering right

When the vehicle is steering right (the rear axle must then steer left about pivoting point D), oil is fed to connections X1 (left) and X2 (right). The oil reaches connection X1 from the left-hand EVS cylinder and will push the piston out. This forces the oil at connection X2 into the reservoir. If the vehicle is steered to the right from the centre position, the main piston will carry the floating piston to the right. The oil is forced out of emergency steering compartment Y2 and partially fills emergency steering compartment Y1. The remaining oil volume returns to the emergency steering accumulator. At the right-hand EVS cylinder the oil reaches connection X2 and the piston will slide in. This forces the oil at connection X1 into the reservoir.

The oil is forced out of emergency steering compartment Y1. Since the volume in emergency steering compartment Y2 does not change (the floating piston stays in place), all of it will flow back to the emergency steering accumulator. The difference in surface area of the main piston at the X1 and X2 side is compensated for by the difference in surface area of the main piston at Y1 and Y2 (ring surface area of floating piston).

4.4 Operation; hydraulic diagram

4.4.1 The steering system

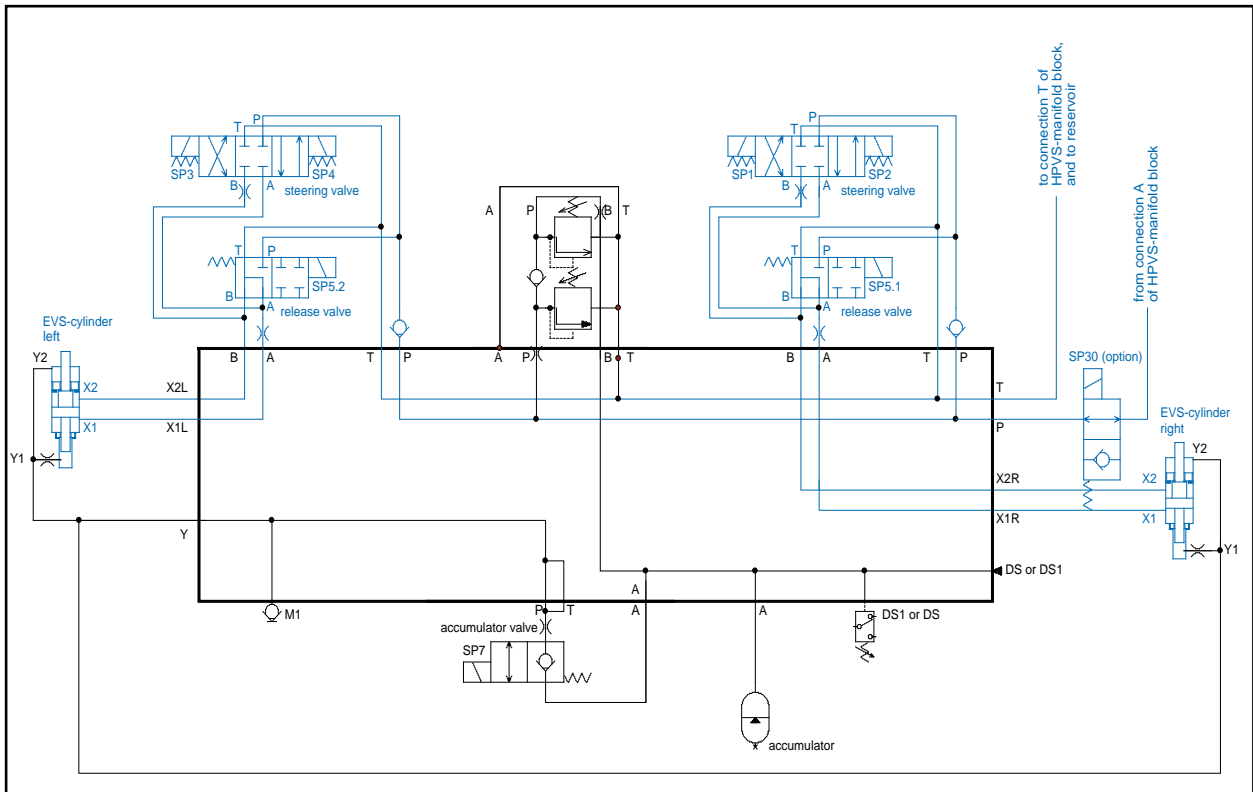

EVS hydraulic diagram: steering system (blue)

The steering system consists of a delivery and return connection from the HPVS manifold block, two steering valves with coils SP1, 2, 3 and 4 and two release valves SP5.1 and 5.2.

The purpose of the steering valves is to operate the steering cylinders.

If the release valves are not energised, the steering system is pressureless and steering is not possible, even if SP1, 2, 3 or 4 is energised. The X1 and X2 pipes are pressureless.

If the release valves are energised, the pump is activated by means of SP12 (see Chapter 2) and one or two of coils SP1 to 4 are energised, oil pressure may be built up in the cylinder(s) so as to make the axle steer.

In order to avoid unwanted oil flows, two throttles have been fitted (at SP1, 2 and SP3, 4). The non-return valves may be in the form of block construction (loose sandwich element) or a cartridge; in the latter case they are fitted in release valves SP5.1 and SP5.2. A few throttles have also been fitted so as to damp the oil flows.

SP5.1 and SP5.2 are connected in series and are therefore fitted with 12 volt magnets to ensure good wire breakage/short-circuit notification.

4.4.2 The emergency steering system

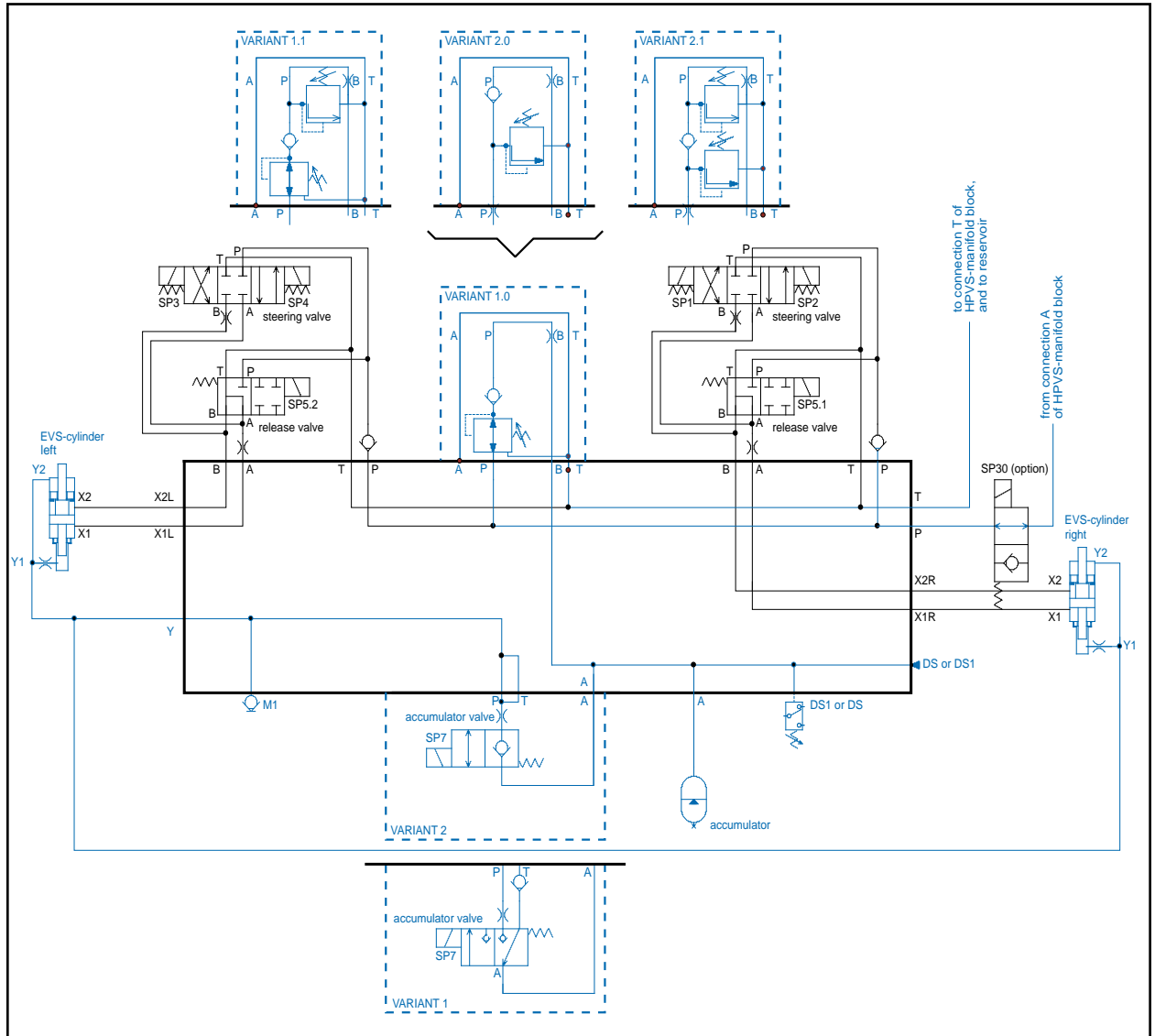

EVS hydraulic diagram: emergency steering system (blue)

EVS hydraulic diagram: emergency steering system (blue)

The emergency steering system consists of an accumulator, pressure switch (DS1 or DS), throttle (B), non-return valve in T and a 3/2 valve SP7. Since the start of 1994 the non-return valve in T, the throttle and the 3/2 valve have been combined in a single valve, a 2/2 valve (variant 2). The operation is identical.

A quantity of oil is constantly stored under pressure in the accumulator and is checked by the pressure switch. Via SP7 there is always pressure on connections Y1 and Y2, so that there is always a centring force on the steering (see also section 4.3.1). When SP7 is energised, oil from the emergency steering system can flow to the accumulator if the pressure in the emergency steering system is higher than the pressure in the accumulator. The axle can steer when the steering system is correctly activated.

When SP7 is not energised, oil can flow only to the emergency steering system, but

not back because of the non-return valve. The axle can only be put more accurately in the straight-ahead position but can never steer (unless there is air in the emergency steering system).

To enable the oil in the emergency steering system to be replenished in the event of a leak, a pressure reduction valve has also been fitted ("variant 1.0"), which allows oil to flow into the system up to a certain maximum preset pressure. The oil cannot flow back due to a non-return valve. There must then be pressure build-up for this valve, so the bypass valve (SP12) must be activated. Activation of this is via the pressure switch and the ECU. Topping up the emergency steering system is done with a high degree of throttling by means of a small throttle. As a result, the pump can still maintain pressure for the normal steering system in the event of a serious leak in the emergency steering system.

The problem with variant 1.0 is that the reduction valve is too slow due to the low level of oil flow. In the event of sudden pressure surges (which happen frequently), the reduction valve closes too late, thereby allowing a small amount of oil to pass. Since in practice the emergency steering system scarcely loses any oil after the non-return valve, the pressure can increase sharply. The results of this may be: steering too slowly, greatly increased wear on the emergency steering accumulator and leakage from the steering cylinders. A new variant was developed because of this problem:

Variant 2.0

In this variant the reduction valve is replaced by a pressure relief valve. This reacts almost immediately (even opening by a small amount is sufficient to stop the pressure from rising). Now, however, the steering pressure could not exceed the preset value, since all the oil can escape to T. To prevent this effect, just before the pressure relief valve a throttle is screwed into the manifold block. It is so small (< 0.5 mm) that the internal oil loss is zero. This will mean, however, that it will take a little longer to fill the emergency steering system (e.g. following a gas initial pressure check). Adjustment is as for the original variant (1.0).

Because of the throttle screwed into the manifold, variant 2.0 cannot be mounted at a later date on vehicles with variant 1.0, because no screw thread has been tapped in these manifolds.

In practice, however, the same problems occurred with this solution as with variant 1.0, though to a lesser extent: here too the emergency steering pressure was able to increase gradually.

Variant 1.1 (replacement for variant 1.0)

An additional pressure relief valve is fitted, after the non-return valve. This ensures that the pressure in the emergency steering system cannot exceed approx. 200 bar. During steering this will mean that the emergency steering system 'blows off' oil. When the axle is then back in the centre position, the emergency steering pressure will be approx. 90-95 bar. After this the pressure can again increase slowly (over a few months) until it is again so high that the pressure relief valve will again blow off.

Variant 2.1 (replacement for variant 2.0)

With variant 2.1 the same modification was made as with the transition from 1.0 to 1.1. After the non-return valve an additional pressure relief valve is fitted, which can blow off the emergency steering pressure if it increases. Otherwise the operation is the same as for variant 1.1.

4.4.3 Steering left

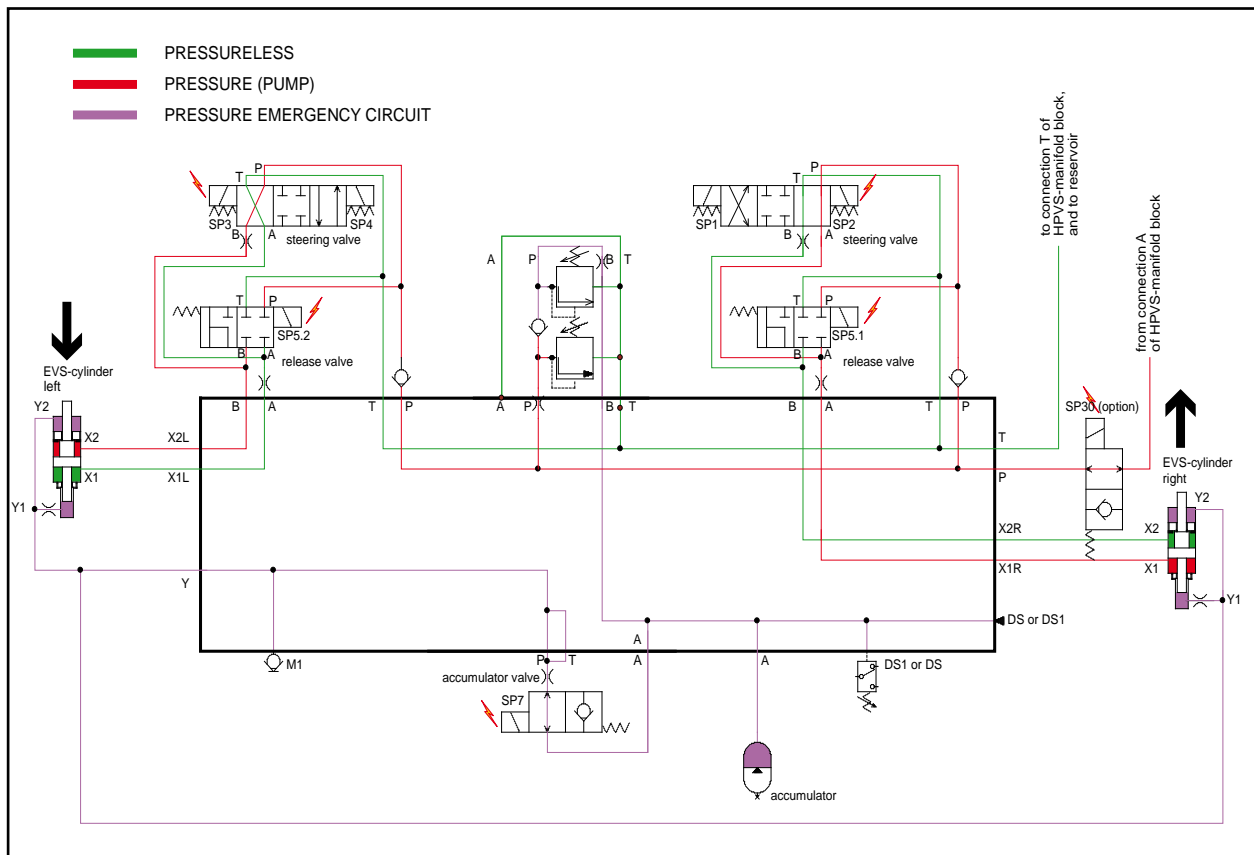

EVS hydraulic diagram: steering left

Steering left from centre position, speed lower than transition speed

When steering left the left-hand cylinder must slide in and the right-hand cylinder slide out. The emergency steering system must be able to release oil to the accumulator. The main steering system must be activated. See also section 4.3.2: Steering left.

Switched valves:

- SP5.1 and SP5.2 so that pressure can be built up in the steering system
- SP7 so that the oil can escape from the emergency steering system of the cylinders towards accumulator
- SP2 oil to X1R, right-hand cylinder slides out
- SP3 oil to X2L, left-hand cylinder slides in
- SP12 so that the pump can build up pressure
- SP30 (if fitted) so that pressure can be built up in the steering system

In practice SP2 may be activated instead of SP1 (or SP4 instead of SP3). This can happen because the cylinder then “overshoots its target” so that it has to go back again. It is also the case that some cylinders slide in and out more easily than others. If there is too much difference between the cylinders, the one that is closest to its target will be

deactivated so as to allow the other one to catch up.

4.4.4 Steering right

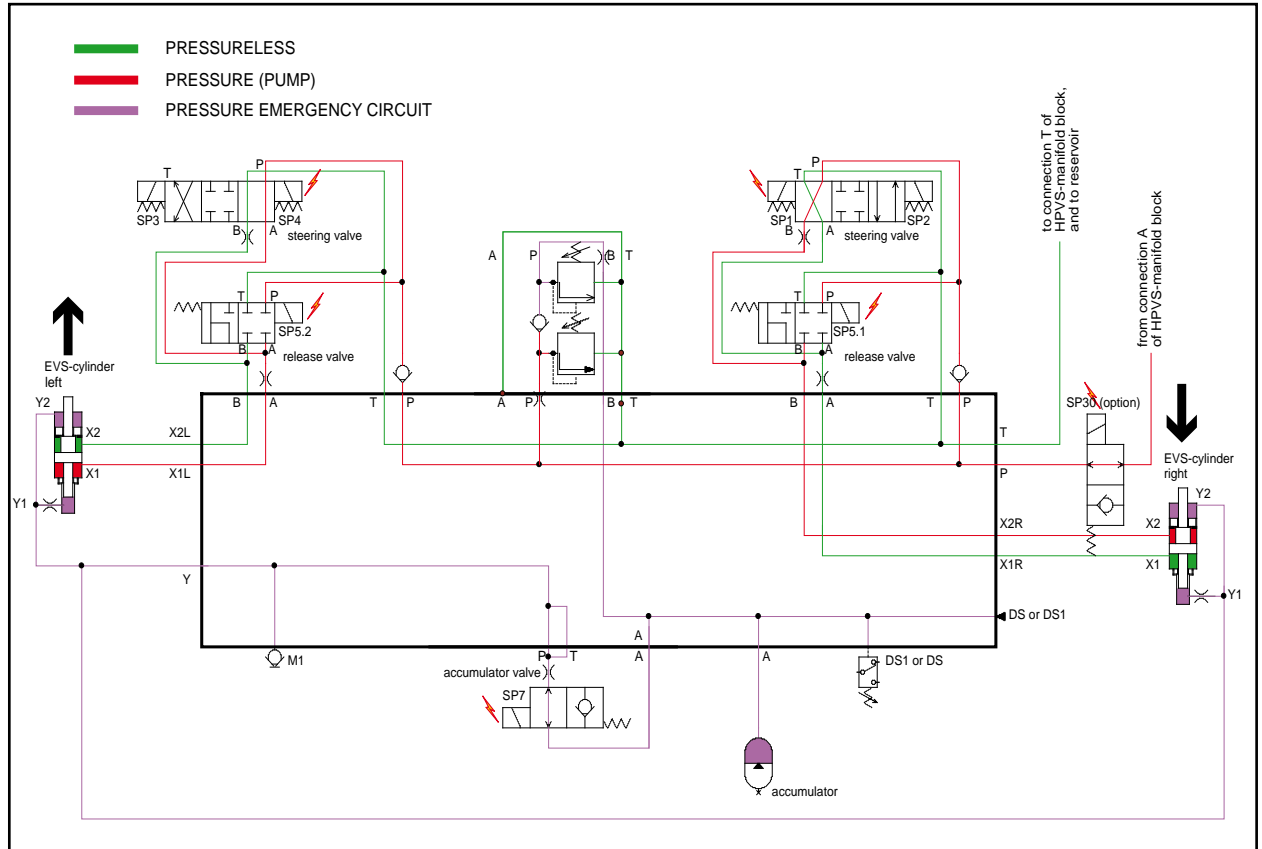

EVS hydraulic diagram: steering right

Steering right from centre position, speed lower than transition speed

When steering right the right-hand cylinder must slide in and the left-hand cylinder slide out. The emergency steering system must be able to release oil to the accumulator. The main steering system must be activated. See also section 4.3.3: Steering right.

Switched valves:

- SP5.1 and SP5.2 so that pressure can be built up in the steering system
- SP7 so that the oil can escape from the emergency steering system of the cylinders towards accumulator
- SP1 oil to X2R, right-hand cylinder slides out
- SP4 oil to X1L, left-hand cylinder slides in
- SP12 so that the pump can build up pressure
- SP30 (if fitted) so that pressure can be built up in the steering system

4.4.5 Rear axle in centre position

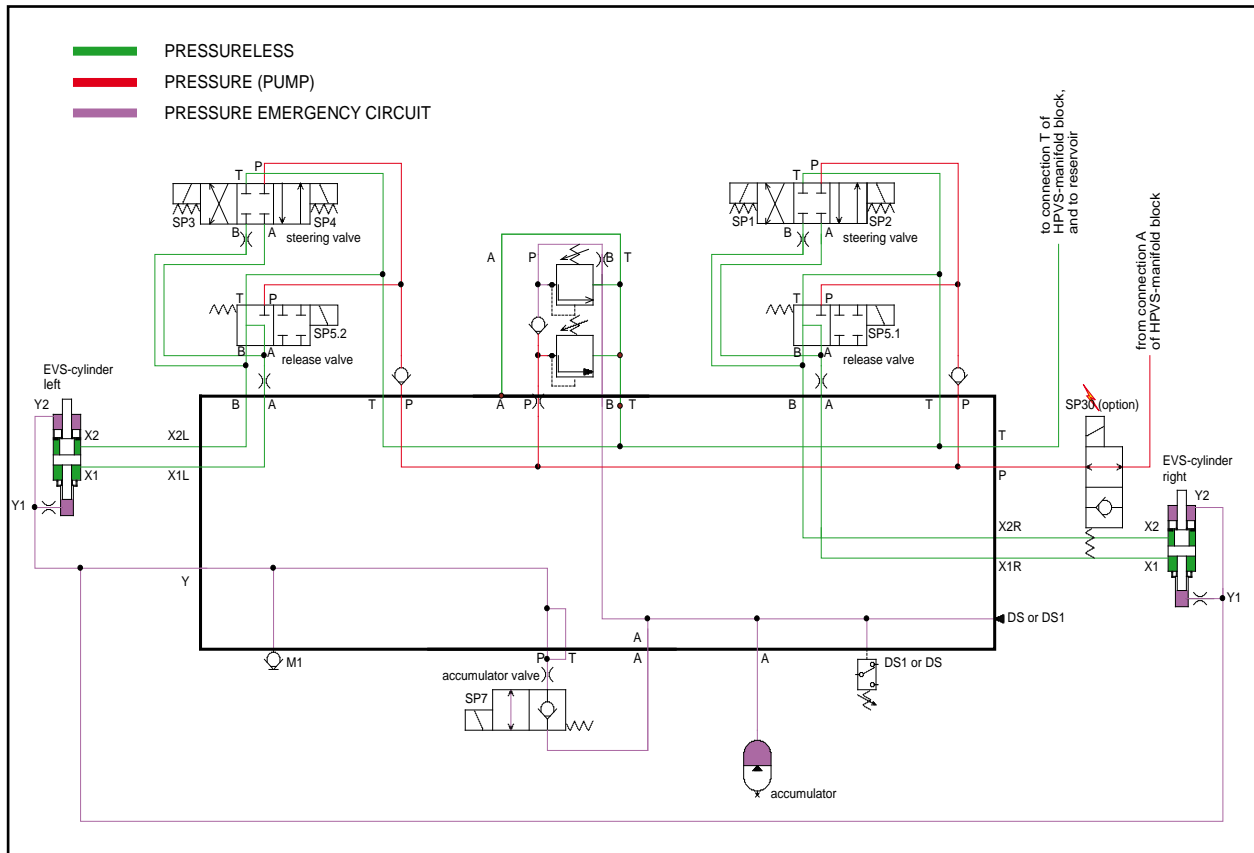

EVS hydraulic diagram: centre position

Front axle around the centre position (driving roughly straight ahead, small corrections permitted), speed lower than transition speed

When the vehicle is being driven roughly straight ahead, steering by the rear axle is not desirable: it must then be 100% straight. This is achieved by deactivating the main steering system and having the rear axle centred by the emergency steering system. When this is done oil must not be allowed to flow to the accumulator as a result of external forces. If the EVS steering switch is 'off', the same situation applies.

Switched valves:

SP30 (if fitted) so that pressure can be built up in the emergency steering system

SP5.1 and SP5.2 are deactivated. Even if SP12 and/or valves SP1 to SP4 are switched on, no pressure is built up.

SP7 is deactivated so as to prevent oil from the emergency steering system from flowing to the accumulator. Oil can now go only from the accumulator to emergency steering connections Y1 and Y2 of the cylinders and not vice versa.

Because of the oil that is under initial pressure in the accumulator, the axle will back-steer until the centre position is reached.

SP12 is also not activated. Note: SP12 can be activated if the HPVS suspension system requests this (e.g. for adjusting the chassis height).

4.4.6 Rear axle in centre position, high speed

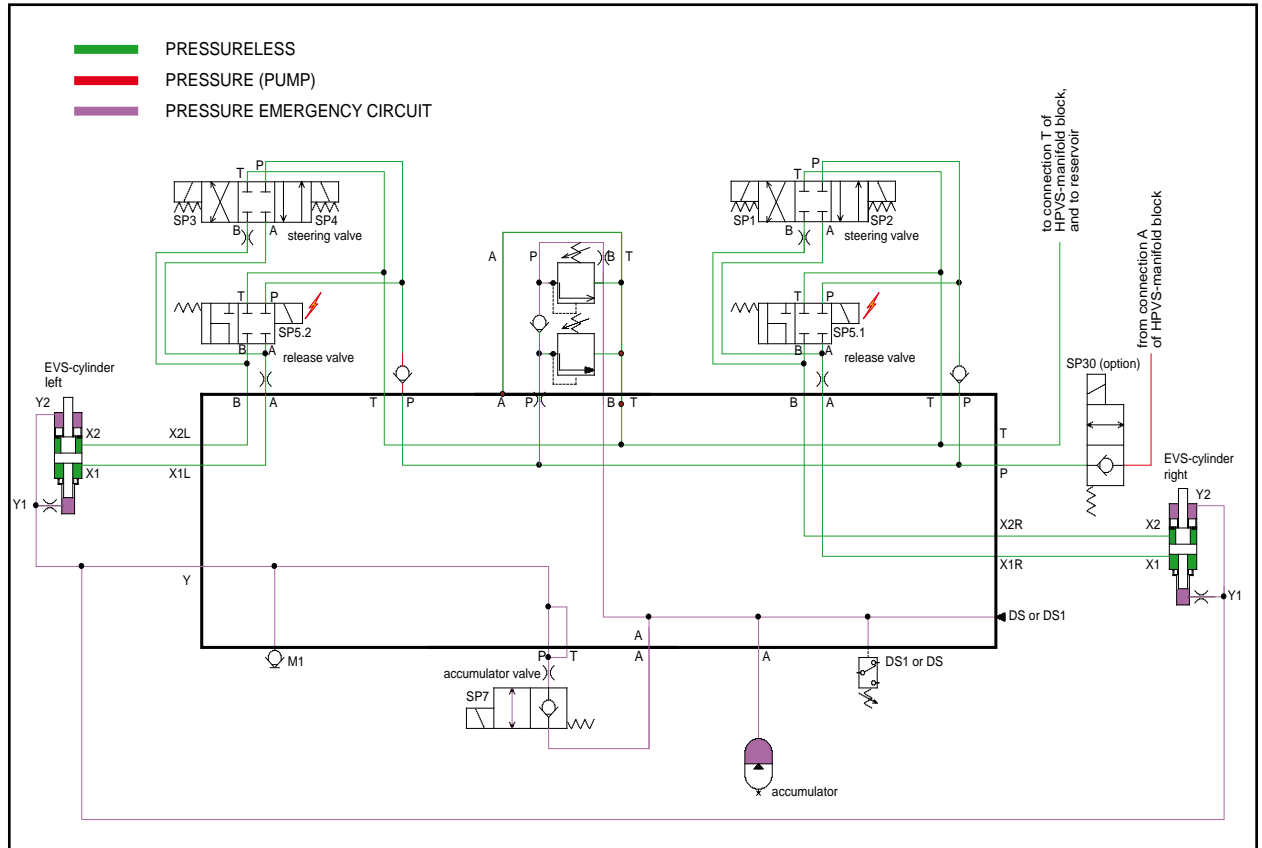

EVS hydraulic diagram: centre position above transition speed

Front axle in any position, speed higher than transition speed

At speeds in excess of the transition speed, the rear axle must not steer so as to assure good vehicle stability. The rear axle is now subjected to dual hydraulic blocking. When the emergency steering system is locked an additional lock is created by activating SP 5.1 and 5.2.

Until end of 1994: from the “rear axle in centre position” situation (see 4.4.5), SP5.1 and 5.2 are energised above 45-50 km/h; SP30 is not fitted.

This causes the X1 and X2 ports to be completely uncoupled, so that the oil can no longer escape from the steering compartments of the cylinders. The same had happened earlier with the emergency steering compartments when SP7 was deactivated. This brings about the dual hydraulic locking. SP12 can still be activated by the HPVS system.

From end of 1994 to end of 1995: ditto, but SP12 could no longer be activated. This is because it was possible for a situation to occur in which SP12 was activated, while a steering valve (SP1 to 4) was inactive. In that eventuality the rear axle starts to steer against the emergency steering pressure; this is not desirable. At vehicle speeds in

excess of 45-50 km/h SP12 is deactivated by the ECU and by an external relay that is activated by the speed signal.

From end of 1995: protection by an additional valve, SP30, which is now energised by the external relay at speeds below 50 km/h and no longer energised at speeds above that. As a result, no oil feed to the EVS manifold block is possible, not even if bypass valve SP12 is energised. This means that SP12 and hence the height control system can also remain active above 50 km/h.

Switched valves:

SP5.1 and SP5.2 so that connections X1 and X2 are uncoupled. This causes the rear axle to be locked by the main steering system.

4.4.7 Change of position of the EVS switch

When the EVS switch is 'off', the system reacts as though the front axle were straight ahead, so that the rear axle is also in the centre position.

The switch can always be operated, though a switch from 'off' to 'on' will only be accepted if the vehicle is being driven at crawling speed; this is so as to avoid dangerous situations. The rear axle will also only steer again when the front axle has been in the straight-ahead position. From 'on' to 'off', however, is accepted at any speed.

Note: the electronics continues to operate, so the HPVS simply remains activated!

Chapter 5

Electrical system

5.1 Components

5.1.1 Proximity switches (height control)

The height control of the HPVS system is usually provided by four proximity switches on two cylinders. Two proximity switches are fitted for each cylinder of the controlled axle.

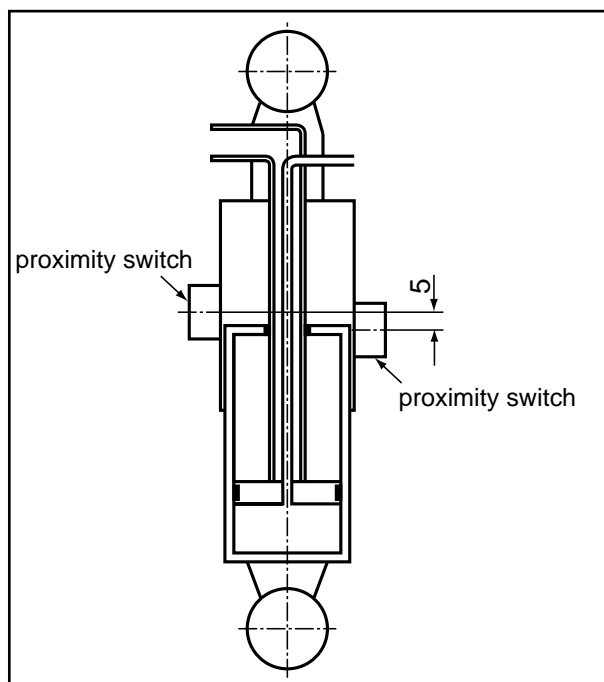

HPVS cylinder with proximity switch

The proximity switches for the height control are basically normal switches with an internal changeover contact. In addition to a power supply wire and an earth wire, two output wires are fitted. Depending on the position of the switch, a voltage that is approx. 0.5 V lower than the supply voltage will be applied to one of the output wires.

The changeover switch does not switch over because a mechanical contact takes place, but because an object is approaching. This proximity switch reacts only to metals. The changeover switch will switch over when metal comes within 12 mm of the sensitive side.

Irrespective of the position of the switch, voltage will always be applied to one output wire and not to the other. The proximity switches are 5 mm apart. The switches with housing are fitted on the cylinder's protective sleeve, in which holes have been made. As a result, they will not switch in reaction to the metal of the protective sleeve. The proximity switches will however switch when the cylinder tube comes past during rebound and compression because it is within the switching distance of 12 mm.

When the chassis is in the driving position the cylinder will be positioned in such a way with respect to the proximity switches that the lowest proximity switch is activated, while the other one is not. Of the output wires, the one that (in the driving position) has no voltage applied to it is now connected to the ECU. For the lowest switch, then, one output (white) is connected, while for the highest one the other output (black) is used.

If the chassis is too low, the spring cylinder is pushed in further. The lowest switch is then switched. This is also the case at driving height, so the output (white) continues to have no voltage applied to it. The output of the highest switch (black) is now also switched, which is not the case at driving height. As a result, the ECU 'sees' that the chassis is too low on the side in question.

If the chassis is too high, the cylinder is pushed out further. The highest switch is then not switched. This is also the case at driving height, so the output (black) continues to have no voltage applied to it. The output of the lowest switch (white) is also not switched, though at driving height it is. As a result, the ECU 'sees' that the chassis is too high on the side in question.

Note! The proximity switches must be accurately positioned in front of the holes in the sleeve, as otherwise the switches will react to the metal in the sleeve rather than the cylinder. The highest and lowest ones must also not be reversed, because the system would then no longer work: there would even be a chance that the vehicle would continually inflate, drain, inflate, drain and so on.

Overview of wiring in proximity switch

4 connecting wires per proximity switch, one of which is always disconnected.

Brown: power supply 24 VDC

Blue: earth

Black: output: 0 V (not switched), approx. 23.5 V (switched)

White: output: approx. 23.5 V (not switched), 0 V (switched)

Wiring in top switch: brown, blue, black

Wiring in bottom switch: brown, blue, white

Only one axle is fitted with height control. The height control system only works at speeds in excess of 5 km/h. The reason for this is that when the vehicle is stationary the controlled axle may be on a bump or in a hollow. With the height control activated this axle would then try to lift or lower the vehicle.

Above 5 km/h the height control system works with a time lag of 3-5 sec between the signal being sent from the proximity switches and the actual activation of the hydraulic valves. This means that they are not activated unnecessarily frequently.

As there is a height difference of 5 mm between the proximity switches, in the most extreme case there could be a difference in chassis height on the left and on the right of 5 mm without it being corrected. Normally, however, this will be barely noticeable.

5.1.2 Fuses

Extra fuses in separate fuse holder in DAF fuse box:

fuse 1 = EVS external power supply (valves, etc.)	24V switched
fuse 2 = EVS internal power supply (5V-24V) + height control + levelling control + switches	24V switched
fuse 3 = heater power supply in ECU	24V switched

5.2 Functions

5.2.1 Lateral levelling control

The levelling unit is completely moulded in a 2-component synthetic resin and is maintenance-free. If the unit fails to function or does not function properly, the entire unit must be replaced.

If the vehicle is on a slope in the lateral direction and the lateral levelling control system is activated by the driver, the ECU activates the height control valves. These ensure that the side that is too high is drained, while at the same time the side that is too low is inflated. While the system is being operated a yellow warning lamp on the dashboard will light up, showing R or L, meaning that the right-hand or left-hand side is too low. As long as one of these lamps is on, the switch must be held. When both lamps are off the vehicle is level.

5.2.2 Container lifting system

A switch for activating this mode is fitted in the cab. The control system only works at speeds below 5 km/h. This means that if the vehicle drives off with the container mode activated it will be deactivated at 5 km/h, so that the chassis is brought back to normal driving height.

The system works by means of two extra proximity switches, one per cylinder, on both cylinders of the last axle. These proximity switches are of a different type to those in the height control system and are therefore not interchangeable with them. When the container lifting mode is activated, the proximity switches on the last axle take over height control. Because the vehicle is stationary (or almost stationary), the normal height control system does not work. This means that the low sensors now do not emit any voltage when there is metal in the vicinity. As the container position sensors are fitted very high up on the protective sleeve of the cylinders, the vehicle must first be lowered before metal comes close. The position has been selected in such a way that it corresponds to a chassis height that is just above the stops.

Overview of wiring in proximity switch of container lifting system

Brown: power supply 24 VDC

Blue: earth

White: output: approx. 23.5 V (not switched), 0 V (switched)

Wiring in switch of container lifting system: brown, blue, white

When this mode is activated the chassis is lowered to approx. 3 cm above the stop bosses. This driving position is maintained, even when the vehicle is moving.

On vehicles with the HPVS v6/0 system both extra proximity switches are connected to the computer.

If fixed (not spring-loaded) switches are fitted (before end of 1993), the lateral control system cannot be operated when the container lifting mode is activated. If the vehicle moves off with the container lifting mode activated, the chassis automatically goes to the driving position. As soon as the vehicle is stationary again, the chassis is lowered back down to the 'container lifting height'.

On vehicles with spring-loaded switches (from end of 1993), the container lifting system is operated in the same way. As soon as another HPVS switch is operated, the container lifting system will be deactivated. If the vehicle moves off with the container lifting mode activated, the chassis automatically goes to the driving position. When the vehicle is stationary again, the chassis is not lowered to the 'container lifting height', but if needed it must be activated again.

5.2.3 Hydraulic lateral stabilisation

Magnet coils SP6.1 and 6.2 are activated. The lateral stabilisation system can be activated by operating a switch. This can be done at any speed; it ensures that rebounding is now impossible or virtually impossible (compression is possible to

a limited extent thanks to the progressive nature of the HPVS). When the lateral stabilisation system is activated, height control, lateral control and highest/lowest position are no longer possible: the computer does not accept them. This is possible with later versions.

Version: series connection of magnet coils 12 VDC.

5.2.4 Hydraulic lateral stabilisation: superstab

Magnet coils SP6.1 and 6.2 are not activated. Superstab is automatically activated and deactivated by the computer, depending on vehicle speed and turning radius (front axle steering angle). It is also possible to activate this mode by operating a switch (if fitted and included in parameter list).

The superstab version can be identified by the fact that when stationary the magnet coils are energised, i.e. the system is not activated unless the circumstances require it or the switch is operated. When the superstab is activated, height control, lateral control and highest/lowest position are no longer possible: the computer does not accept them. This is possible with later versions.

Version: series connection of magnet coils 12 VDC.

5.3 Switches and warning lamps

5.3.1 G-series switches until 1995

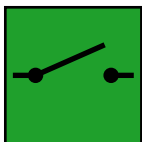

EVS on/off (fixed two-position switch)

'On' = rear axle steering activated. Voltage to the ECU.

'Off' = rear axle steering deactivated. No voltage to the ECU.

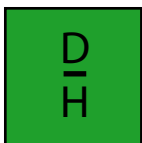

Height control/lateral levelling control (three-position switch), spring return to centre position from D-position (until end of 1993) or spring return to centre position from D and H-positions (from end of 1993).

Centre position = automatic height control at speeds > 5 km/h. No voltage to ECU.

Position 'H' = chassis manually to driving height. Voltage to ECU.

Spring-loaded switch: pressing 1x, mode remains activated until either another switch is operated or the speed becomes > 5 km/h.

Position 'D' = lateral levelling control: vehicle is levelled by means of level sensor provided speed is approx. 0 km/h. Otherwise 'aut. height control' is automatically activated. Voltage to ECU.

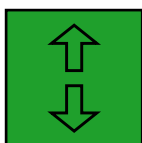

Highest/lowest position (three-position switch, remains in selected position (until end of 1993) or returning to centre position (from end of 1993))

Centre position = operation according to D/H switch. No voltage to ECU.

Position '↑' = highest position (both HPVS valves 'inflating'). Voltage to ECU.

Spring-loaded switch: pressing 1x, mode remains activated until either another switch is operated or the speed becomes > 5 km/h.

Position '↓' = lowest position (both HPVS valves 'draining'). Voltage to ECU.

Spring-loaded switch: pressing 1x, mode remains activated until either another switch is operated or the speed becomes > 5 km/h.

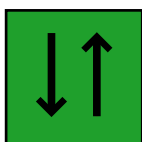

Raising/lowering lifting axle (three-position switch, returning to the centre position)

Centre position = lifting axle not operated, no voltage to ECU

Position '↑': pressing 1x; raising axle, voltage to ECU.

Position '↓': pressing 1x; lowering axle, voltage to ECU (only at speeds < 20 km/h).

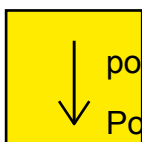

Container lifting system (two-position switch, remains in selected position (until end of 1993) or spring-loaded (from end of 1993)).

Position 'on' = container lifting mode. Voltage to ECU.

Spring-loaded switches: pressing 1x, mode remains activated until either another switch is operated or the speed becomes > 5 km/h.

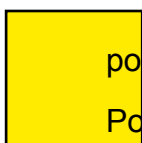

Lateral stabilisation system (two-position switch) remains in selected position (until end of 1993) or spring-loaded (from end of 1993).

Position 'off' = lateral stabilisation. Voltage to ECU.

Spring-loaded switch: pressing 1x, mode remains activated until the switch is again operated (minimum interval: approx. 2 sec.).

5.3.2 G-series warning lamps until 1995



EVS/HPVS oil level

Activation from ECU (vehicles without lifting axle), lamp stays on until reset + enough oil.

Activation from float switch via relay (vehicles with lifting axle), lamp is on as long as oil level is too low.

Fault message stays in ECU memory.



EVS/HPVS pressure filter

Activation via pressure filter indicator. Only on vehicles built prior to 1993.



Lateral levelling control, left side too low



Lateral levelling control, right side too low

Activation from the level sensor: these lamps can only come on if the vehicle is sloping towards one side and if the lateral control system is activated (D on the D/H switch).

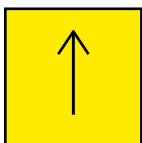

Lifting axle raised

Activation when axle is raised.

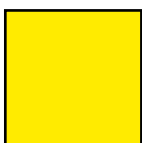

Lateral stabilisation

Warning lamp in the switch.

5.3.3 M and G-series switches from 1995 to 1998

Remarks:

The system reacts to switches being operated only at vehicle speeds below 1 km/h (except for lateral stabilisation: at any speed).

Any function can be deactivated by pressing lateral levelling control 1x.

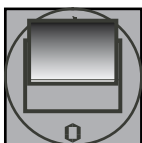

EVS on/off (fixed two-position switch)

'1' = steering activated. Voltage to the ECU.

'0' = steering deactivated. No voltage to the ECU.

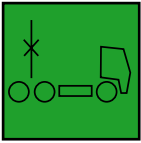

Height control (spring-loaded switch)

After the vehicle is started the automatic height control system is activated at speeds > 5 km/h.

When height control is operated 1x it stays activated until another switch is operated or until the speed becomes > 5 km/h. Voltage to ECU as long as switch is pressed.

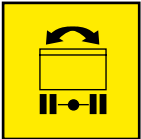

Lateral levelling control

As long as the switch is pressed, the vehicle is levelled by means of the level sensor, provided the speed is approx. 0 km/h. Otherwise the automatic height control system is automatically activated. Voltage to ECU as long as switch is pressed.

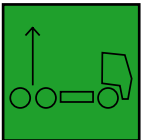

Highest position (spring-loaded switch)

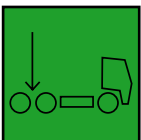

Lowest position (spring-loaded switch)

When highest or lowest position is operated 1x, it stays activated until another switch is operated or the speed becomes > 5 km/h. Voltage to ECU as long as switch is pressed.

From end of 1995: mode remains activated as long as switch is pressed.



Container lifting system (spring-loaded switch)

When operated 1x, container lifting mode is activated (chassis is lowered to approx. 3 cm above axle stops). Voltage to ECU as long as switch is pressed.

This position stays activated until another switch is operated or the speed becomes > 5 km/h.



Raising lifting axle (spring-loaded switch)

When operated 1x, lifting axle is raised. Voltage to ECU as long as switch is pressed.

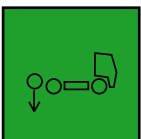

Lowering lifting axle (spring-loaded switch)

When operated 1x, lifting axle is lowered and with HPVS version v3/3 is coupled. Voltage to ECU as long as switch is pressed.

Remarks:

On some vehicles only "raising lifting axle" is available. The axle is lowered when the same switch is operated (minimum interval approx. 2 sec.).

The lifting axle can only be lowered at speeds < 20 km/h.

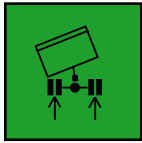

Lateral stabilisation (spring-loaded switch)

When operated 1x, lateral stabilisation is activated; when operated again, lateral stabilisation is deactivated (minimum interval approx. 2 sec.). Voltage to ECU as long as switch is pressed.

5.3.4 M and G-series warning lamps from 1995 to 1998



EVS/HPVS oil level

Activation from ECU (vehicles without lifting axle), lamp stays on until reset + enough oil.

Activation from float switch via relay (vehicles with lifting axle), lamp is on as long as oil level is too low.

Fault message stays in ECU memory.



Lateral levelling control, left side too low



Lateral levelling control, right side too low

Activation from the level sensor: these lamps can only come on if the vehicle is sloping towards one side and if the lateral control system is activated (D on the D/H switch).

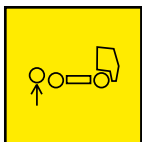

Lifting axle raised

Activation when axle is raised.

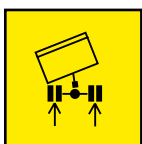

Lateral stabilisation

Warning lamp in the switch.

5.4 Software

Due to the complexity of the system software it is beyond the scope of this document to describe it in detail. Still, we would like to focus on a number of aspects that are important for understanding the steering.

5.4.1 Zero point hysteresis

When a vehicle is driving in approximately a straight line, the rear axle does not need to steer and indeed this may even have detrimental effects. A “nervy” type of behaviour will

result because a small degree of steering is still taking place. As a result, the rear axle steering angle will also constantly be modified.

In addition, the sensors may vary slightly, i.e. the electronic centre position is no longer the same as the actual centre position. For the cylinders the harmful effect of this is avoided by having the centre position calculated by the emergency steering system when driving straight ahead.

Zero point hysteresis means that the front axle can be steered to the left and to the right by approx. 3 degrees in respect of the centre position without the rear axle steering. This makes for smooth driving and steering behaviour and insensitivity to sensor deviations, while excessive wear is also avoided.

5.4.2 Counter-steering factor

This is the factor by which the relationship between the rear axle angle and the front axle angle can be set. The relationship can be set according to the wheel base, the front axle wheel deflection (which determines the calculation front axle angle) and the distance from the non-steered rigid axle to the rigid axle steered by EVS.

Example: given the same front axle angle the rear axle angle must be larger with a short wheel base than it is for the same vehicle with a longer wheel base. On very long vehicles it may even be the case that the maximum rear axle angle is too large, so that at the maximum front axle angle the rear axle does not have to steer to the maximum.

5.4.3 Proportional back-steering effect

To prevent a sudden transition from 'steering' to 'not steering', EVS uses a so-called proportional back-steering effect.

If the front axle steering angle is kept constant and at the same time the vehicle speed is increased, the rear axle steering angle gradually decreases until the steering angle is 0 degrees at the transition speed from steering to non-steering. Back-steering takes place in 13 stages, so that the driver experiences this as a continuous process. The stages are laid down in the parameters.

5.4.4 Rear axle steering angle limit

The full steering angle that the cylinders can attain cannot be utilised because with standard tyres the steering angle has to be limited. This is because with a large oscillating angle and full steering the wheels can touch the cylinders. The distance that the rear axle can steer is therefore laid down in the program by means of parameters.

5.4.5 Correction factor

Factor that is determined for each vehicle by starting up the 'CORR' utility program in the test box.

By steering both the front axle and the rear axle fully, the divergence of the sensor in respect of "ideal" is determined. The factor determined from this adjusts the measured

values in such a way that the actual values are changed to the ideal maximums when steering is also actually at a maximum.

This means that in the event of any changes in the sensors this program must be used afresh. This utility program must also be used when the fault message “corr. factoren zijn niet meer geldig” (“corr. factors are no longer valid”) is displayed.

5.4.6 Synchronisation of both cylinders

The hydraulic steering system is designed in such a way that the cylinder that requires the lowest pressure to move will also move first. This causes the axle to tilt. To prevent this, an electronic alignment device is fitted. If one cylinder gets too far ahead of the other, the one nearest to its target will ‘wait’ for the other one.

This means that if one cylinder does not move (jammed control slide, too little force in the case of very heavy rutting) the other one moves briefly but then stops while it waits for the first one. This may be followed by a fault code (discrepancy too large between target and actual = target-actual fault).

5.4.7 Existing hysteresis

Built into almost all the values that are related to the steering system is a hysteresis, the purpose of which is to ensure that the steering system does not work in a jerky fashion. The existing throttles in the system flatten out any pressure peaks that may occur in the system.

5.5 Fault messages

Fault messages can be displayed in two ways:

5.5.1 Via the DCS-1 diagnostics unit



DCS-1 diagnostics unit

The diagnostics unit enables the fault messages stored in the ECU’s memory to be displayed by selecting ‘FOUT’ (‘FAULT’). After the list has been displayed there is the option of deleting the fault messages from the memory or leaving them there. If the fault message ‘correctiefactoren niet geldig’ (‘correction factors not valid’) is shown, the

correction factors must be entered again using the 'CORR' utility program, since this fault message can only be removed by having the correction factors determined afresh.

Connecting DCS-1 diagnostics unit

To prevent problems with the memory from arising due to static electricity, the following procedure must be followed when connecting the diagnostics unit:

1. Connect the DCS-1 to the ECU.
2. Switch the vehicle ignition on. The DCS-1 is ready for use.

5.5.2 Via flashing code

Any stored fault messages in the ECU can also be displayed via the alarm lamp on the dashboard. After the display procedure is started up the lamp can indicate which fault messages are present by flashing a certain number of times.

Displaying fault messages with flashing code

1. Make sure the vehicle is stationary, the vehicle ignition is on and the lifting axle (if fitted) is down.
2. Press the "lateral levelling control" and "highest or lowest position" switches simultaneously and hold them down for 3-5 seconds until a pulsing buzzer signal is heard.
3. Release the switches.

The system is now in "display flashing code" mode. If there are no fault messages stored in the ECU, the buzzer will give two short signals. If there are, the alarm lamp will start flashing.

4. Count the number of times the lamp flashes until the buzzer gives a short signal. If there are further fault messages in the ECU, the next fault message is shown. This is repeated until all fault messages have been displayed. The buzzer then again gives several short signals.
5. See table below for which fault message corresponds to which flashing code.

Deleting the faults stored in the ECU

Display the fault code by following the above procedure. Press the "lateral levelling control" and "highest or lowest position" switches simultaneously and hold them down as soon as the buzzer gives several short signals at the end of the display procedure. After about 5 seconds the buzzer will again emit a signal. Release the switches. All fault messages have now been deleted; this can be checked by trying to display them again.

5.5.3 Overview of fault messages

The following table gives a brief description of all possible fault messages. Below the table a more detailed description of each message can be found.

Code no.	Number of flashes	Description
1	1	Emergency steering system pressure too low, $v > 5$ km/h
2	2	Oil level too low
3.1	3	Left-rear target-actual discrepancy too large
3.2	3	Right-rear target-actual discrepancy too large
4	4	Speed measured too irregular
5.1	5	Value of front corner sensor too small
5.2	5	Value of front angle sensor too large
6.1	6	Value of length sensor in left-rear cylinder too small
6.2	6	Value of length sensor in left-rear cylinder too large
7.1	7	Value of length sensor in right-rear cylinder too small
7.2	7	Value of length sensor in right-rear cylinder too large
8.1	8	Wire breakage/short-circuit in SP1
8.2	8	Wire breakage/short-circuit in SP2
8.3	8	Wire breakage/short-circuit in SP3
8.4	8	Wire breakage/short-circuit in SP4
9	9	Wire breakage/short-circuit in SP5.1 and/or SP5.2
10	10	Wire breakage/short-circuit in SP7
11.1	11	Wire breakage/short-circuit in SP8
11.2	11	Wire breakage/short-circuit in SP9
11.3	11	Wire breakage/short-circuit in SP10
11.4	11	Wire breakage/short-circuit in SP11
12	12	Wire breakage/short-circuit in SP12
13	13	Wire breakage/short-circuit in SP13
14	14	Wire breakage/short-circuit in SP6.1 and/or SP6.2
15	15	Lateral levelling and height control activated simultaneously
16.1	16	Both proximity switches on left activated
16.2	16	Both proximity switches on right activated
17	17	Both level sensors activated
18	18	Wire breakage/short-circuit in SP14
19	19	Wire breakage/short-circuit in SP15.1 and/or SP15.2
20	0 (via DCS-1)	Correction factors no longer valid

Fault code 1

The pressure in the emergency steering system is monitored by the pressure switch mounted on DS1 or DS (depending on vehicle type and superstructure). If this pressure becomes too low, the pressure switch switches after approx. 8 sec. provided the speed is in excess of 5 km/h. Below 5 km/h no fault message is triggered because owing to

slight internal leakage oil may leak out of the emergency steering system while the ignition is on and the engine off.

When the pressure switch switches, the steering system is put in the straight-ahead position and bypass valve SP12 is activated in order to compensate for the leak. If this is not successful within approx. 3 sec. at $v = 5$ to 45 km/h, a fault message is generated: the main steering system ensures that the axle is put in the straight-ahead position.

Fault code 2

If the oil level as measured with a float switch remains below the minimum for longer than 10 seconds, a fault message is generated and the emergency steering system is activated in order to steer the rear axle to the centre position. The HPVS control system is also deactivated. Lowest position and lowering lifting axle (if fitted) are operations that are still possible!

Fault code 3.1

The ECU continuously examines whether the difference between the desired value (target) and the actual value (actual) is not too large. The difference between these values can also be too large without this being due to a fault, for example if the ignition is on with the engine off. This is why no check is run at $v < 5$ km/h.

It may also happen that with rapid steering and a low engine speed the rear axle cannot steer quickly enough. In this situation the system must not generate a fault message. A target-actual fault message may arise as a result of another fault, for example wire breakage in the angle sensor at left or right rear. The emergency steering system is activated until the axle is in the straight-ahead position. SP5.1 and SP5.2 are not activated, not even at high speed. The reason for this is that when bypass valve SP12 is activated for, say, HPVS the cylinders will still attempt to steer against the locked emergency steering system if, for instance, a steering valve (SP1 to 4) is jammed in the switched state.

(Before mid-1993 SP5.1 and SP5.2 were activated at high speed when this fault code was generated).

Fault code 3.2

As for fault code 3.1, for right rear.

Fault code 4

The ECU receives the speed signal via D3 in the tachograph or via the DAF system's CTE (central time unit). The pulses from D3 or from the CTE are not received, or only very irregularly, on the ECU. The system reacts as for fault code 3.1, though now with dual locking by activation of SP5.1 and SP5.2.

Fault code 5.1

Wire breakage or short-circuit in the circuit of the front angle sensor. The system reacts as for fault code 4.

Fault code 5.2

Wire breakage or short-circuit in the circuit of the front angle sensor. The system reacts as for fault code 4.

Fault code 6.1

Wire breakage or short-circuit in the circuit of the length sensor in the left rear cylinder. The system reacts as for fault code 3.1.

Fault code 6.2

Wire breakage or short-circuit in the circuit of the length sensor in the left rear cylinder. The system reacts as for fault code 3.1.

Fault code 7.1

Wire breakage or short-circuit in the circuit of the length sensor in the right rear cylinder. The system reacts as for fault code 3.1.

Fault code 7.2

Wire breakage or short-circuit in the circuit of the length sensor in the right rear cylinder. The system reacts as for fault code 3.1.

Fault code 8.1

A check is run for this when the valve is activated. Voltage must be constantly present for approx. 1 sec. The system reacts as for fault code 4.

Fault code 8.2

As for fault code 8.1, for SP2.

Fault code 8.3

As for fault code 8.1, for SP3.

Fault code 8.4

As for fault code 8.1, for SP4.

Fault code 9

A check is run for this when the valve is activated. Voltage must be constantly present for approx. 1 sec. The system reacts as for fault code 3.1.

Fault code 10

A check is run for this when the valve is activated. Voltage must be constantly present for approx. 1 sec. The system reacts as for fault code 4.

Fault code 11.1

A check is run for this when the valve is activated. Voltage must be constantly present for approx. 1 sec. The steering system remains activated.

Fault code 11.2

As for fault code 11.1, for SP9.

Fault code 11.3

As for fault code 11.1, for SP10.

Fault code 11.4

As for fault code 11.1, for SP11.

Fault code 12

A check is run for this when the valve is activated. Voltage must be constantly present for approx. 1 sec. The system reacts as for fault code 2.

Fault code 13

Hier wordt op gecontroleerd wanneer de klep wordt aangestuurd. Er moet ca. 1 sec. A check is run for this when the valve is activated. Voltage must be constantly present for approx. 1 sec. The system remains activated, the buzzer gives a signal.

Note: on M series, and from end of 1993, SP13 is no longer fitted.

Fault code 14

A check is run for this when the valve is activated. Voltage must be constantly present for approx. 1 sec. Where superstab is fitted: as for fault code 11.1, otherwise the system continues to work as normal.

Fault code 15

Height and lateral levelling control systems are deactivated, steering system continues to function.

Note: on vehicles with 'spring-loaded switches' this fault code is not possible.

Fault code 16.1

Height control is deactivated, lateral levelling control and steering system are working normally.

Fault code 16.2

As for fault code 16.2, for right-hand side.

Fault code 17

Lateral levelling control is deactivated, height control and steering system are working normally.

Fault code 18

A check is run for this when the valve is activated. Voltage must be constantly present for approx. 1 sec. Raising the lifting axle is deactivated.

Fault code 19

A check is run for this when the valve is activated. Voltage must be constantly present for approx. 1 sec. Raising and lowering the lifting axle are deactivated.

Fault code 20

This fault code can only be displayed by means of DCS-1. The correction factors stored in the ECU are no longer valid. The computer then uses the default values to make calculations, as though ideal sensors were fitted. No system reaction (also no buzzer).

Remarks:

The system's reaction in the event of a particular fault message applies only to that specific fault message. It may be that one fault message is the result of another fault message. Example: fault code 1: leakage in emergency steering system - as a result, oil level too low after a while: fault code 2. **If several fault messages are given, then, it is important to find the primary cause during diagnostics!**

From end of 1995: some fault messages only become active when they have occurred 5x in quick succession. After a fault message the system resets itself and on the 5th time the fault is reported to the driver. Obviously this does not apply to fault messages that could be dangerous, such as AL1, AL2 (emergency steering pressure too low, oil level too low respectively) and AL20 (correction factors no longer valid).

In general, the driver will get a signal when a fault occurs or has occurred. In the case of EVS faults, both the alarm lamp and the buzzer will be activated, while in the event of HPVS faults only the alarm lamp will come on.

5.6 Electrical diagrams

The circuit diagrams are arranged in such a way that the ECU is considered to be a black box. This means that only the connections that are outside the ECU are shown. The diagrams are also split into section diagrams so as to make things easier to read.

The colour of the wiring can be identified in the diagrams by a code consisting of the first and last letters of the colour, e.g. "red" = "rd", etc.

5.6.1 Overview of connectors and trimming potentiometers in e3 ECU

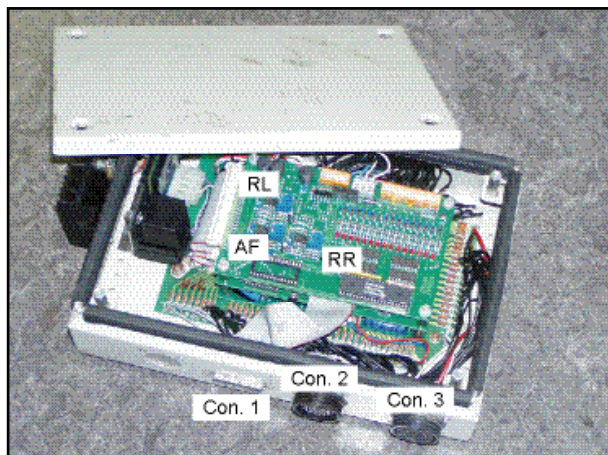

Con. 1: Connector 1 (for DCS-1)

Con. 2: Connector 2

Con. 3: Connector 3

RL: Length sensor EVS cylinder left

RR: Length-sensor EVS cylinder right

AF: Front angle potentiometer

5.6.2 Overview of circuit diagrams for M series

Diagram number	Description
11314	Connection to coils for HPVS and EVS valves
11315	Connection to potentiometers
11316	Connection to height control system
11317	Connection to proximity switches
11318	Connection to warning lamps, buzzer and nightlight switches
11319	Connection to lateral levelling control system, pressure switches, float switch, flow indicator, tachograph
11320	Power supply to ECU
11321	Power supply to ECU with lifting axle
13128	Connection to container lifting system

The diagrams mentioned can be found on the following pages.

Diagram 11314/01

Connection to coils for HPVS and EVS valves

SP1	EVS valve in rear right cylinder for sliding in
SP2	EVS valve in rear right cylinder for sliding out
SP3	EVS valve in rear left cylinder for sliding in
SP4	EVS valve in rear left cylinder for sliding out
SP5	Release valves: these are connected in series (12 volt coils)
SP6	Lateral stabilisation valves: these are connected in series (12 volt coils)
SP7	Accumulator valve
SP8	Valve for HPVS inflating, right
SP9	Valve for HPVS draining, right
SP10	Valve for HPVS inflating, left
SP11	Valve for HPVS draining, left
SP12	Bypass valve
SP14	Lifting valve: see also diagram 11328, connection to warning lamp, lifting axle up
SP15	Uncoupling valves: these are connected in series (12 volt coils). See also diagram 11321
SP30	Valve for closing EVS system

Connector	No. of pins	Shape	Position
Con. 2	37 bk	round	ECU
Con. 4	39 bk	round	Behind bulkhead on co-driver's side

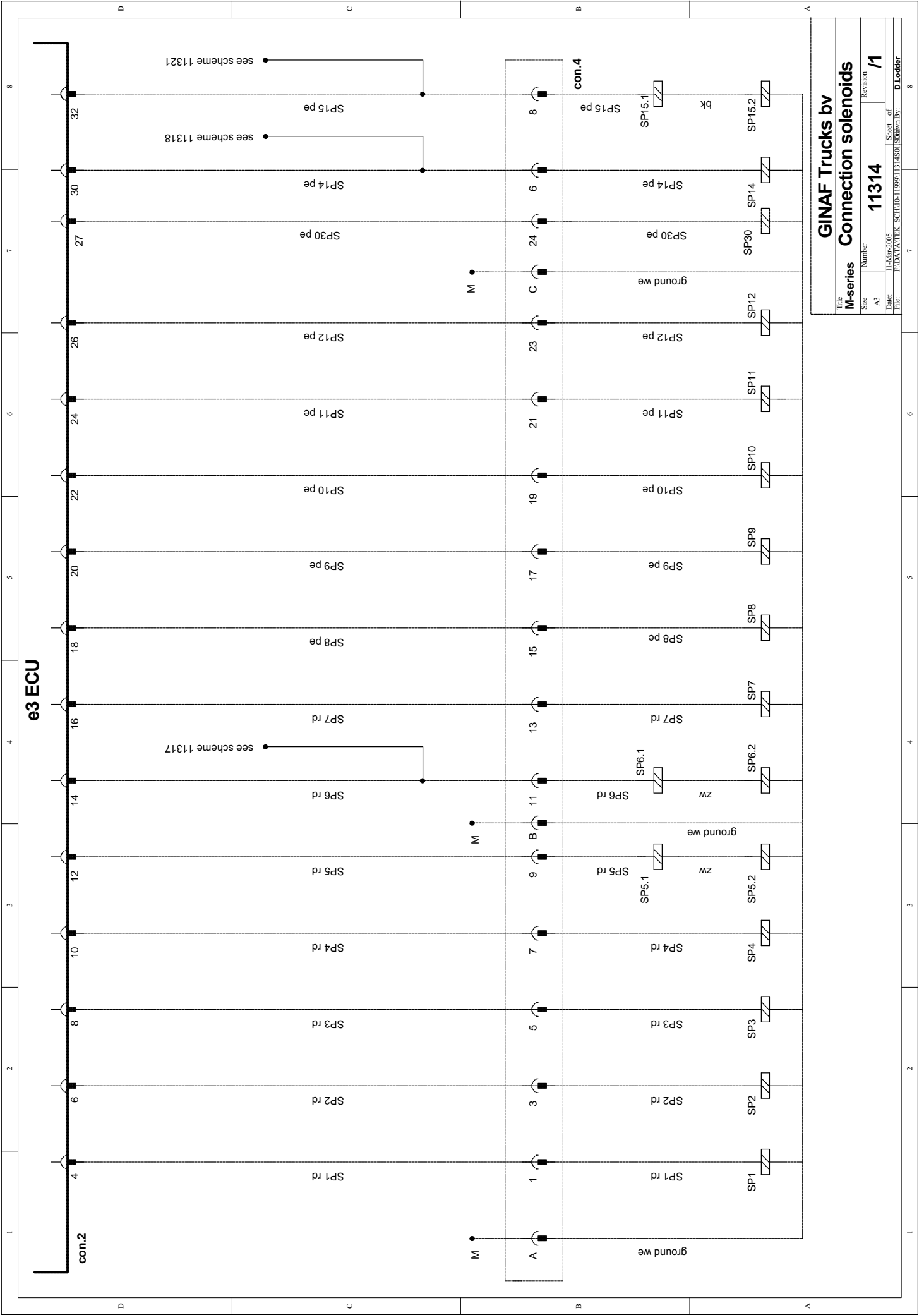

GINAF Trucks by

M-series Connection solenoids

Title	M-series	Revision	/1
Size	A3	Number	
Date	11-Mar-2005	Sheet of	
File	P:\DATA\VEK_SCH\1119901131\AS01\Solenvi.BY: D.Loider		

Diagram 11315/00

Connection to potentiometers

Potm front Front angle sensor

Potm rear left Length sensor for rear left cylinder

Potm rear right Length sensor for rear right cylinder

Connector	No. of pins	Shape	Position
Con. 3	37 bk	round	ECU
Con. 5	14 bk	round	Behind bulkhead on co-driver's side
Con. 6	4 bk	round	Near steering box
Con. 7	4 yw	round	On V-rod, 2nd tandem axle
Con. 8	4 we	round	On V-rod, 2nd tandem axle

G = Central earthing point, cab behind bulkhead, co-driver's side

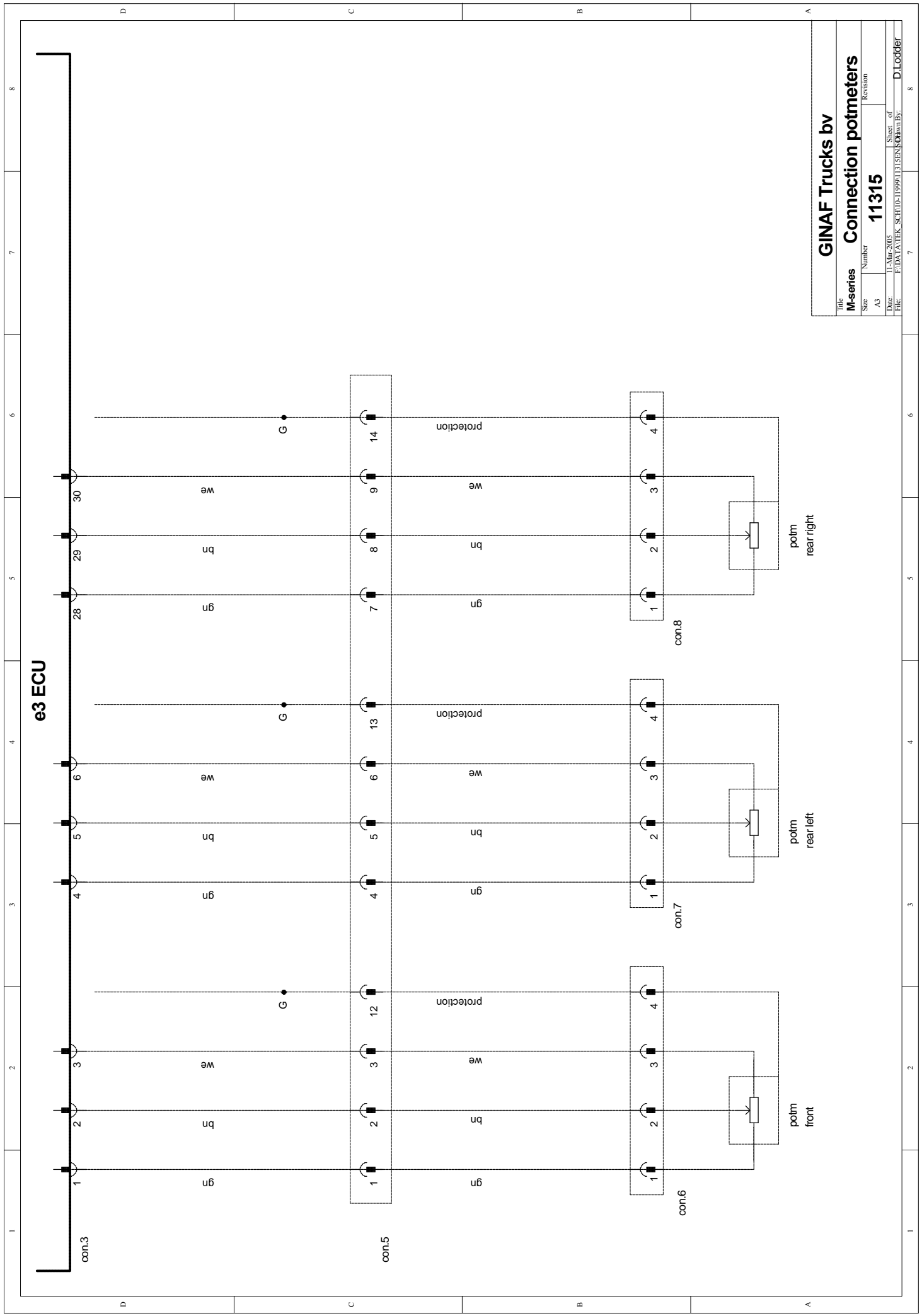

GINAF Trucks by			
Title	M-series Connection potmeters		
Size	Number	Revision	
A3	11315		
Date:	1-Mar-2005	Sheet of	
File:	F:\DATA\VEK_SCH\101999\11315\EN\SCH\wv1.bv	D.Lodder	

Diagram 11316/00

Connection to height control system

Switch	Description
B 1	Proximity switch for inflating, left
B 2	Proximity switch for draining, left
B 3	Proximity switch for inflating, right
B 4	Proximity switch for draining, right
B 5	Proximity switch for draining, left, for container lifting system. If a lifting axle is fitted, this switch is used for checking the lifting axle
B 6	Proximity switch for draining, right, for container lifting system.

Connector	No. of pins	Shape	Position
Con. 2	37 bk	round	ECU
Con. 4	39 bk	round	Behind bulkhead on co-driver's side
Con. 9	4 bk	round	Inside of chassis on left near 1st tandem axle
Con. 10	4 bk	round	Inside of chassis on right near 1st tandem axle
Con. 11	4 bk	round	In trlr tow bar

G = Central earthing point, cab behind bulkhead, co-driver's side

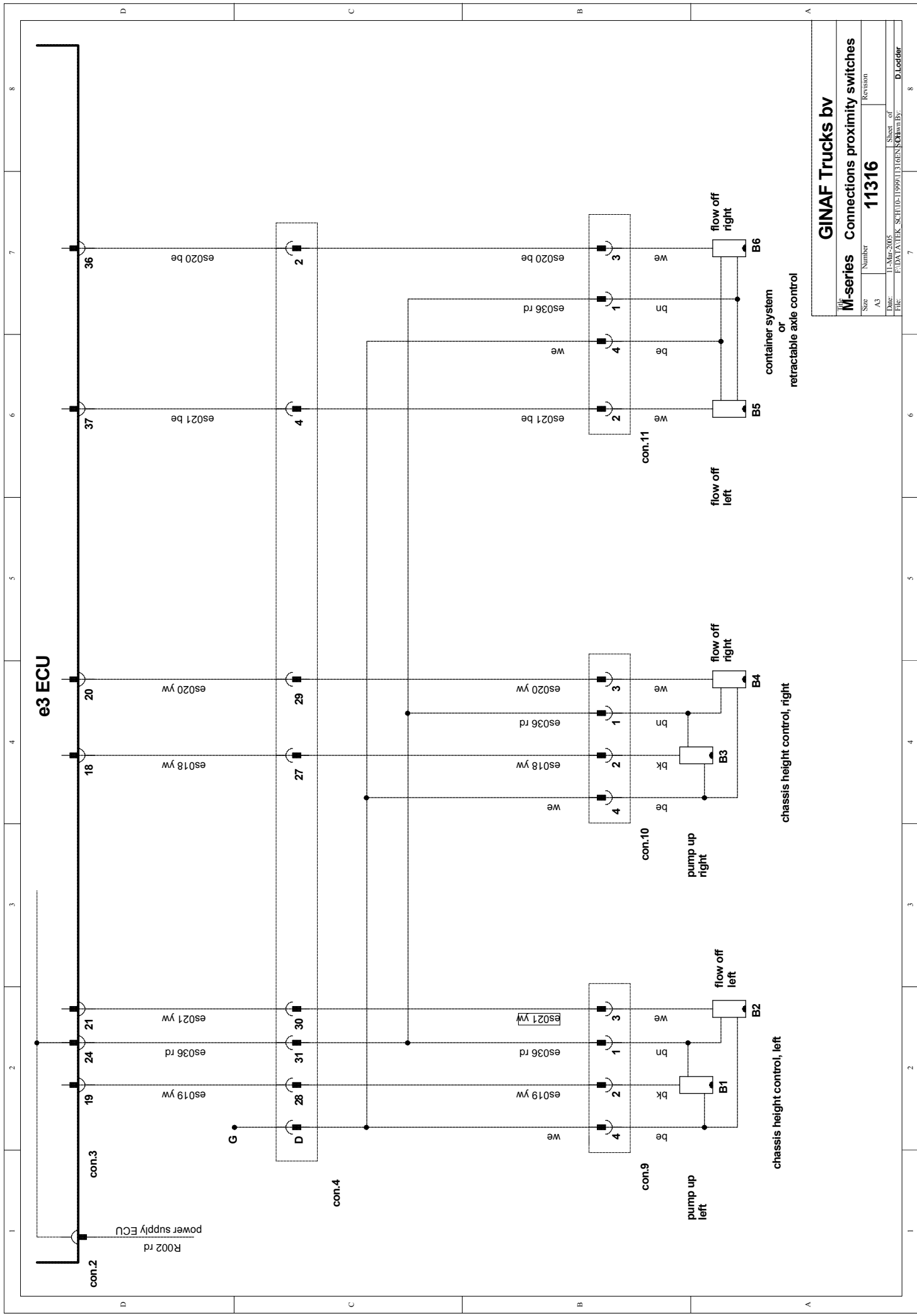

GINAF Trucks bv	
M-series	Connections proximity switches
Size A3	Revision
Date: 11-Mar-2005	Sheet of
File: F:\DATA\TEK_SCH\111999\11306\ES_SCH\wv1.bv	11316
D.Lordor	

Diagram 11317/00

Connection to switches

Switch	Description
S 1	Switch for highest position
S 2	Switch for lowest position
S 3	Switch for driving position
S 4	Switch for lateral levelling control
S 5	Switch for raising lifting axle
S 6	Switch for lowering lifting axle
S 7	Switch for container lifting system
S 8	Switch for lateral stabilisation
S 9	Switch for EVS on/off

Connector	No. of pins	Shape	Position
Con. 2	37 bk	round	ECU
Con. 3	37 bk	round	ECU
Con. 12	20 we	rectangular	Behind CWS (panel with warning symbols in dashboard)

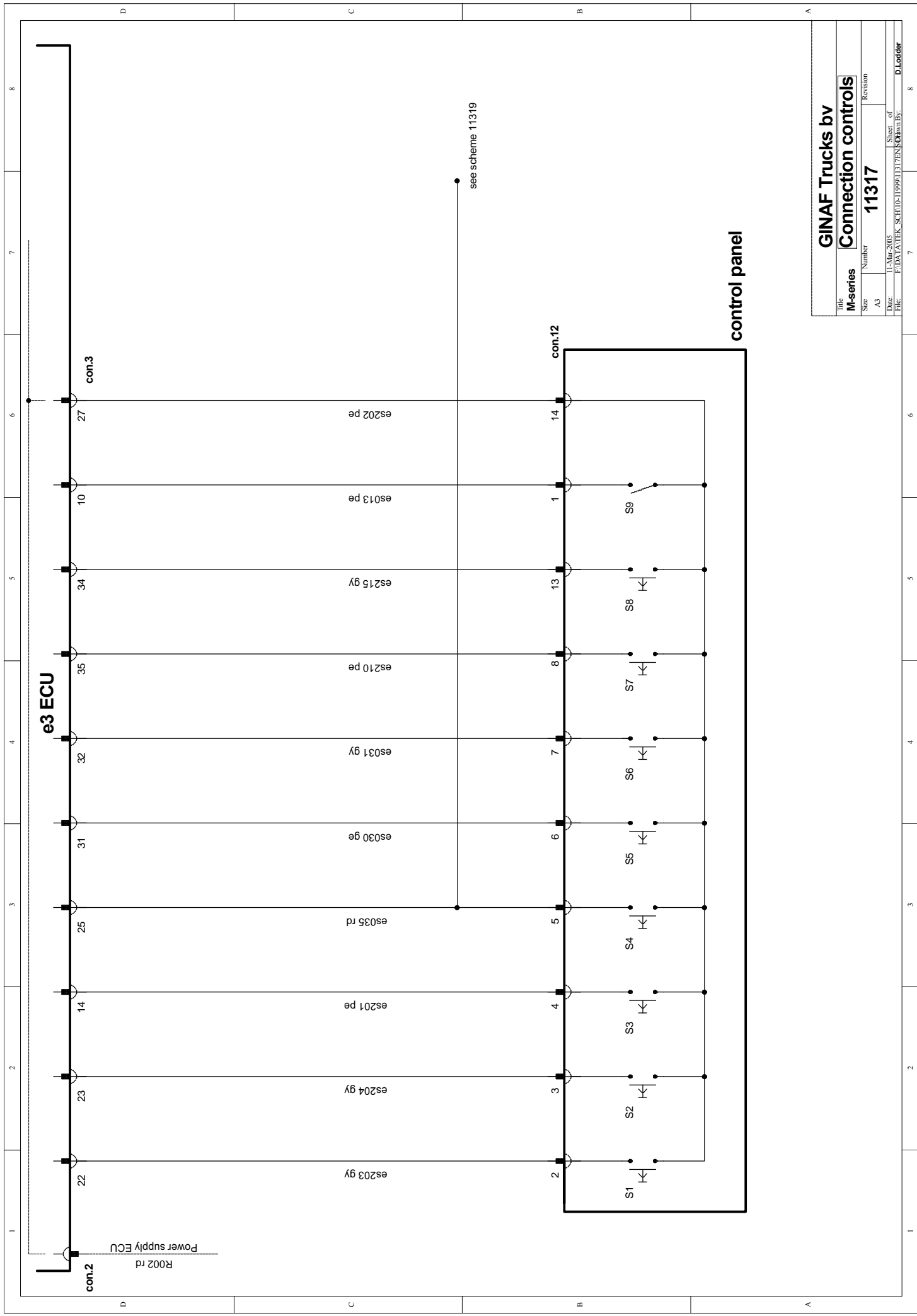

Title		GINAF Trucks by	
M-series		Connection controls	
Size	Number	Revision	
A3		11317	
Date:	1-Mar-2005	Sheet of	
File:	F:\DATA\VEK_SCH\11317\EN\SCH\11317.D	D.Loader	

Diagram 11318/00

Connection to warning lamps

Lamp	Description
L 1	Warning lamp indicating HPVS/EVS fault message
L 2	Warning lamp indicating oil level too low
L 3	Warning lamp indicating left side of vehicle too low
L 4	Warning lamp indicating right side of vehicle too low
L 5	Lifting axle warning lamp
L 6	Lateral stabilisation warning lamp
L 7	Nightlight switches on control panel

Connector	No. of pins	Shape	Position
Con. 2	37 bk	round	ECU
Con. 3	37 bk	round	ECU
Con. 4	39 bk	round	Behind bulkhead on co-driver's side
Con. 13	20 we	rectangular	Behind CWS (panel with warning symbols in dashboard)
Con. 14	15 we	rectangular	On fuse panel, position 205
Buzzer		round/red	In fuse box

G = Central earthing point, cab behind bulkhead, co-driver's side

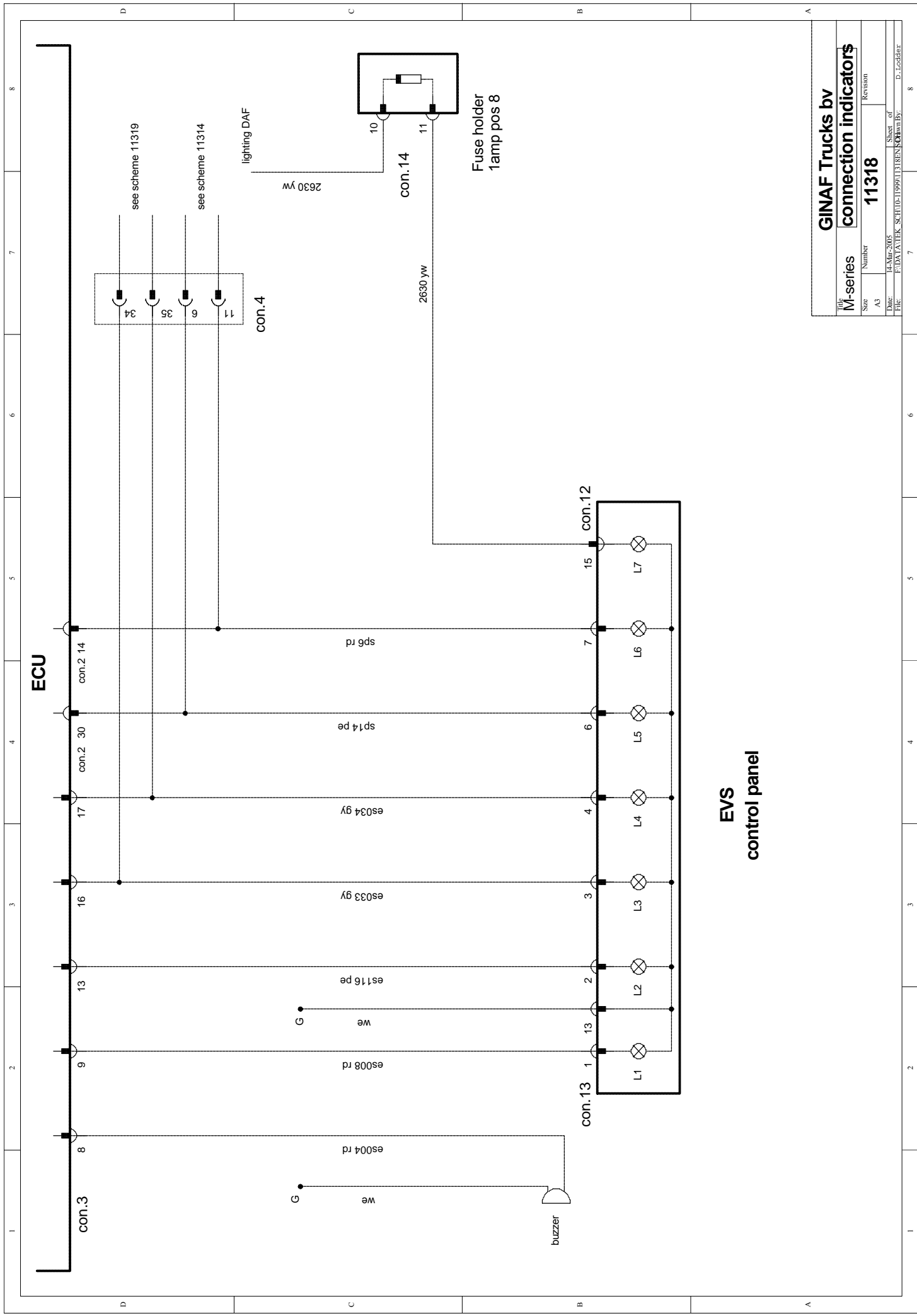

GINAF Trucks by			
connection indicators			
Title		Revision	
M-series	Number	11318	
Size	A3	Sheet of	
Date	14-Mar-2005	D. Logdax	
File	F:\DATA\VEK_SCH\11318\11318SCH.WM	D. Logdax	

Diagram 11319/00

Connection to lateral levelling control system, pressure switches, oil level, flow indicator and tachograph

Switch	Description
--------	-------------

S 10	Pressure switch, emergency steering system
------	--

S 11	Switch for oil level or flow indicator
------	--

W.p.d.reg	Sensor for lateral levelling control
-----------	--------------------------------------

Connector	No. of pins	Shape	Position
Con. 3	37 bk	round	ECU
Con. 4	39 bk	round	Behind bulkhead on co-driver's side
Con. 15	4 rd	round	In trlr tow bar
Con. 16	20 we	rectangular	In fuse box

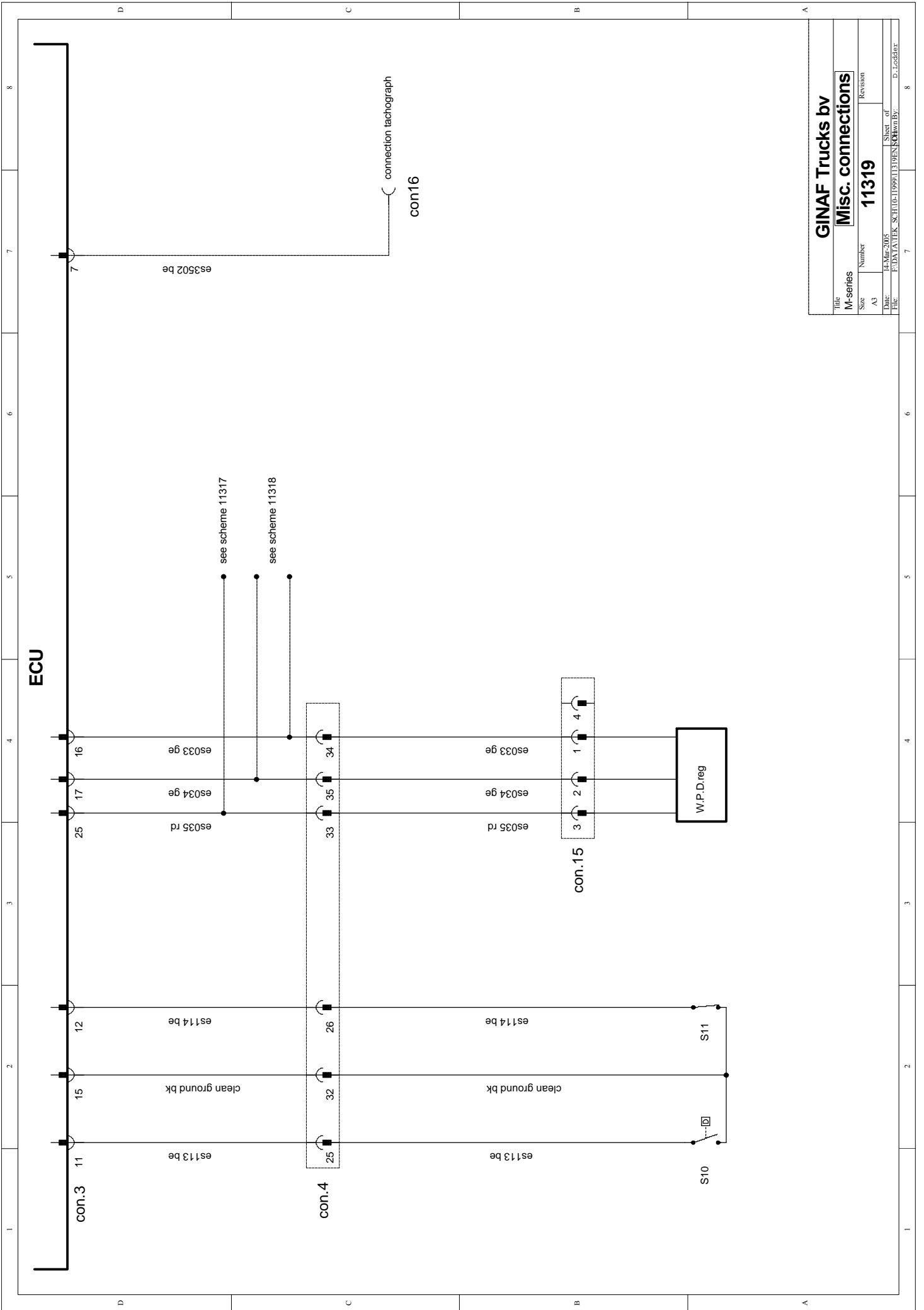

GINAF Trucks bv	
Title	Misc. connections
Size	A3
Date	14-Mar-2005
File	F:\DATA\TEK_SCH\TD1999\1319EN\SCH\wv1.bv
Number	11319
Revision	
Sheet of	8
D. Ledger	

Diagram 11320/01

Power supply to ECU

Comp.	Description
Z 1	Fuse for heating element
Z 2	Fuse for ECU internal circuit and for power supply to switches and proximity switches
Z 3	Fuse for coils
rd	DAF contact relay

Connector	No. of pins	Shape	Position
Con. 2	37 bk	round	ECU
Con. 14	15 we	rectangular	On fuse panel, position 205

G = Central earthing point, cab behind bulkhead, co-driver's side

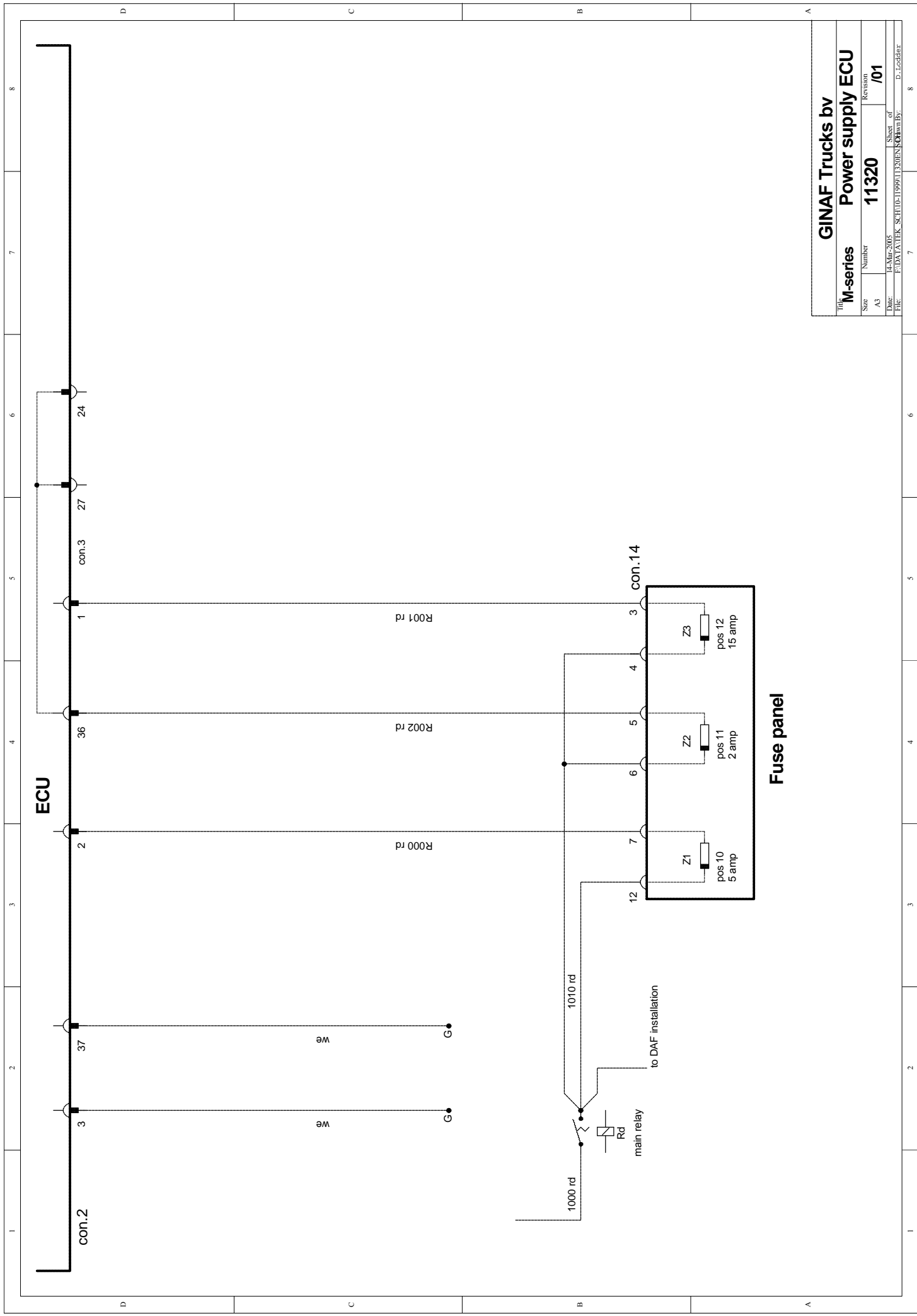

Title		GINAF Trucks by	
M-series		Power supply ECU	
Size	Number	Revision	
A3	11320		/01
Date:	14-Mar-2005	Sheet of	
File:	F:\DATA\TEK_SCH\11320\11320E\SCH\11320E.SCH	Drawn By:	D. Ledger

Diagram 11321/01

Power supply to ECU with lifting axle

Lamp	Description
Z 1	Fuse for heating element
Z 2	Fuse for ECU internal circuit and for power supply to switches and proximity switches
Z 3	Fuse for coils
D 1	Single diode
R 1	Changeover relay
R 2	Changeover relay
R 3	Changeover relay

Connector	No. of pins	Shape	Position
Con. 2	37 bk	round	ECU
Con. 3	37 bk	round	ECU
Con. 4	39 bk	round	Behind bulkhead on co-driver's side
Con. 12	20 we	rectangular	Behind CWS (panel with warning symbols in dashboard)
Con. 14	15 we	rectangular	On fuse panel, position 205

G = Central earthing point, cab behind bulkhead, co-driver's side

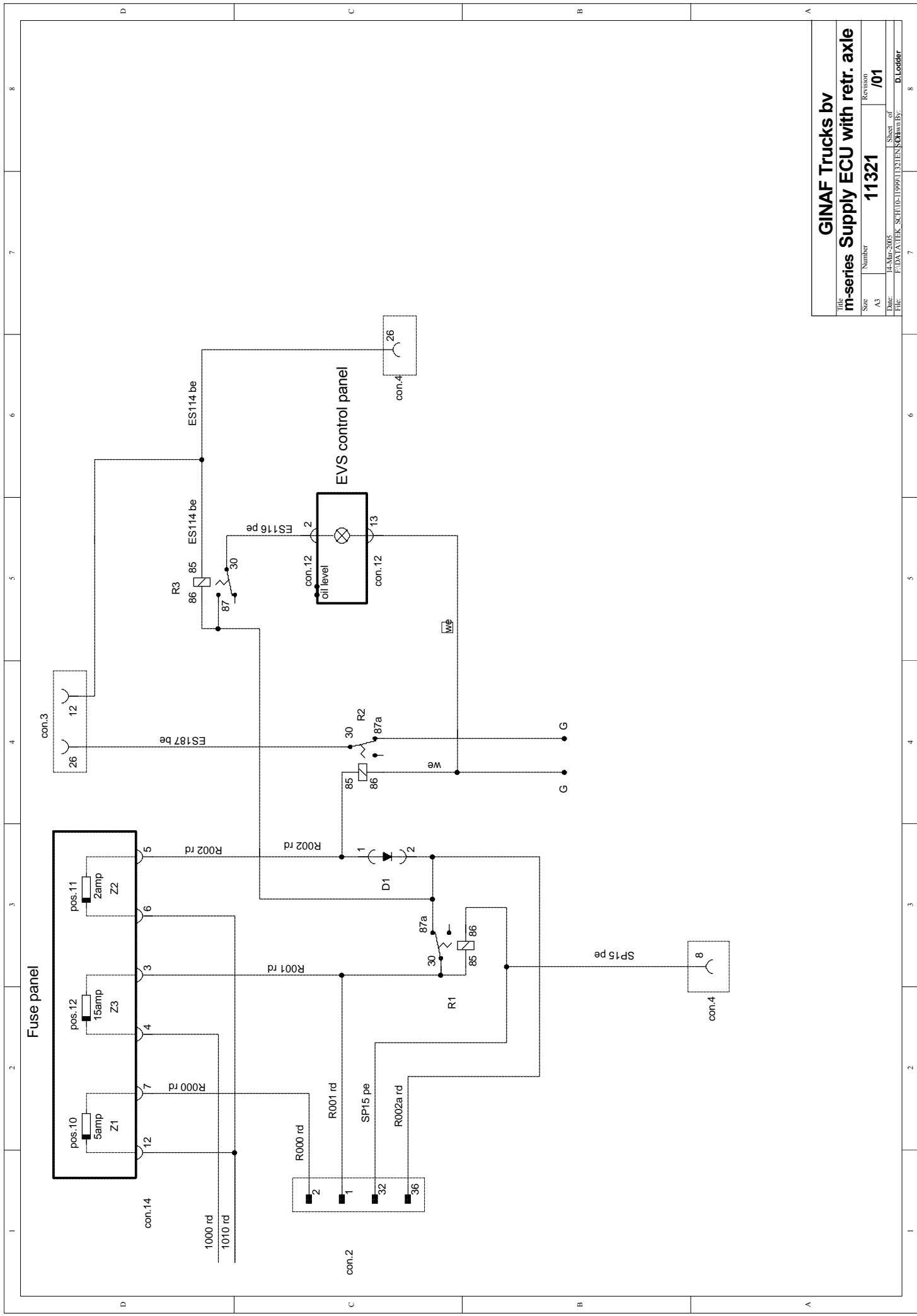

Title		GINAF Trucks by	
m-series		Supply ECU with retr. axle	
Size	Number	Revision	
A3	11321	/01	
Date:	14-Mar-2005	Sheet of	8
File:	F:\DATA\VEK_SCH\11321\11321EVS.SCH	Drawn By:	D.Lodder

Diagram 13128/00

Connection to container lifting system (vehicle with lifting axle)

The relays are located in the fuse panel.

Diode D1 is located in the control panel.

5.6.3 Overview of circuit diagrams for G series

Diagram number	Description
11322	Connection to coils for HPVS and EVS valves
11323	Connection to potentiometers
11324	Connection to height control system
11325	Connection to proximity switches
13369	Connection to operating switches, version from 1995
11326	Connection to warning lamps, buzzer and nightlight switches
13370	Connection to warning lamps, buzzer and nightlight switches, version from 1995
11327	Connection to lateral levelling control system, pressure switches, oil level, flow indicator and tachograph
11328	Power supply to ECU
11329	Power supply to ECU with lifting axle
13371	Power supply to ECU, version from 1995
13372	Power supply to ECU with lifting axle, version from 1995
13128	Connection to container lifting system

The diagrams mentioned can be found on the following pages.

Diagram 11322/01

Connection to coils for HPVS and EVS valves

Coil	Description
SP1	EVS valve in rear right cylinder for sliding in
SP2	EVS valve in rear right cylinder for sliding out
SP3	EVS valve in rear left cylinder for sliding in
SP4	EVS valve in rear left cylinder for sliding out
SP5	Release valves: these are connected in series (12 volt coils)
SP6	Lateral stabilisation valves: these are connected in series (12 volt coils)
SP7	Accumulator valve
SP8	Valve for HPVS inflating, right
SP9	Valve for HPVS draining, right
SP10	Valve for HPVS inflating, left
SP11	Valve for HPVS draining, left
SP12	Bypass valve
SP14	Lifting valve: see also diagram 11328, connection to warning lamp, lifting axle up
SP15	Uncoupling valves: these are connected in series (12 volt coils)
SP30	Valve for closing EVS system

Connector	No. of pins	Shape	Position
Con. 2	37 bk	round	ECU
Con. 4	39 bk	round	Behind bulkhead on co-driver's side

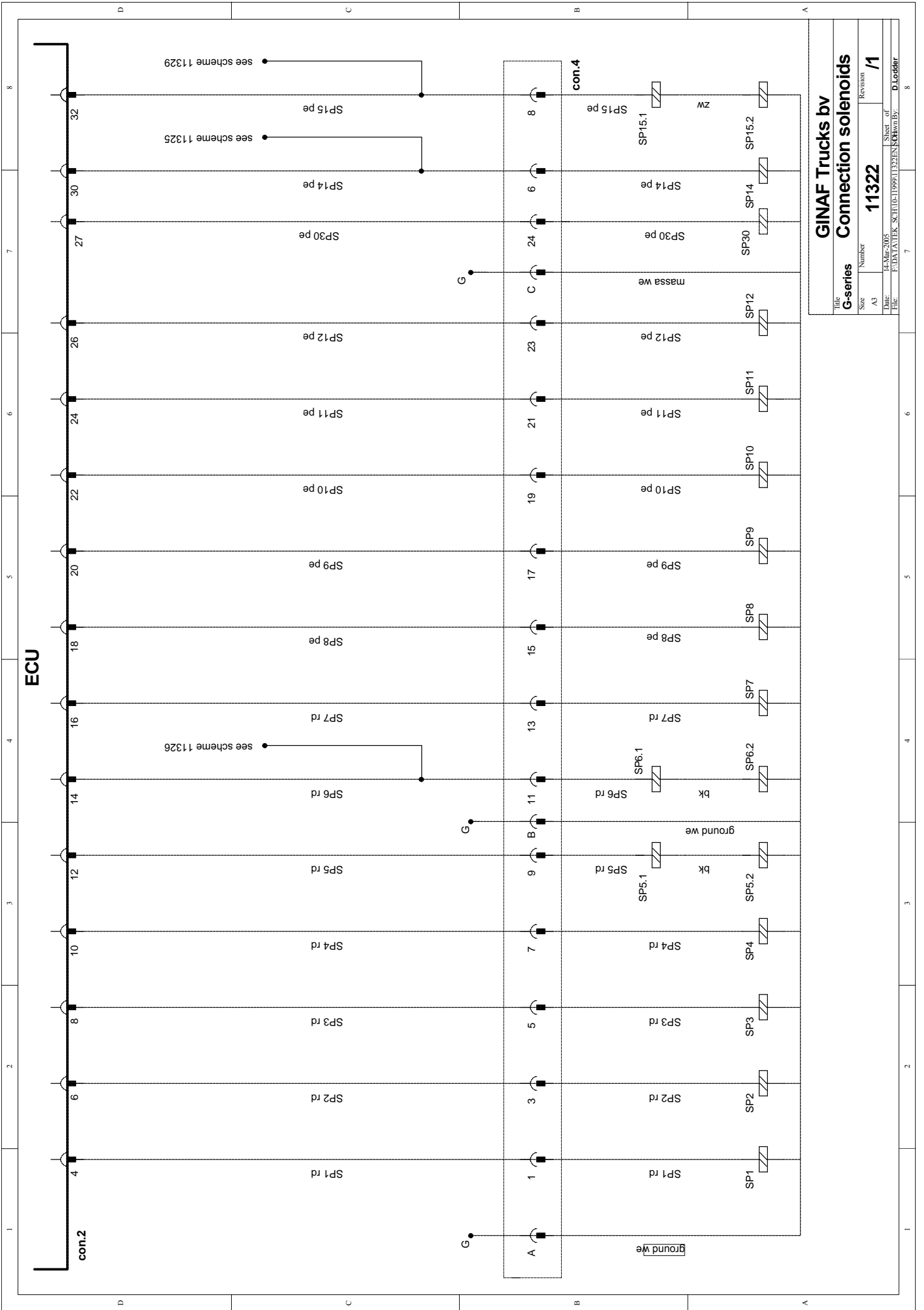

Title		GINAF Trucks by	
Size		G-series	
Number		Connection solenoids	
Revision		/1	
Date:	14-Mar-2005	Sheet of	
File:	F:\DATA\TEK_SCH\11325\11325E\SCHW1.BY		
		D.Lodder	

Diagram 11323/00

Connection to potentiometers

Potm front	Front angle sensor
Potm rear left	Length sensor for rear left cylinder
Potm rear right	Length sensor for rear right cylinder

Connector	No. of pins	Shape	Position
Con. 3	37 bk	round	ECU
Con. 5	14 bk	round	Behind bulkhead on co-driver's side
Con. 6	4 bk	round	Near steering box
Con. 7	4 yw	round	On V-rod, 2nd tandem axle
Con. 8	4 we	round	On V-rod, 2nd tandem axle

G = Central earthing point, cab behind bulkhead, co-driver's side

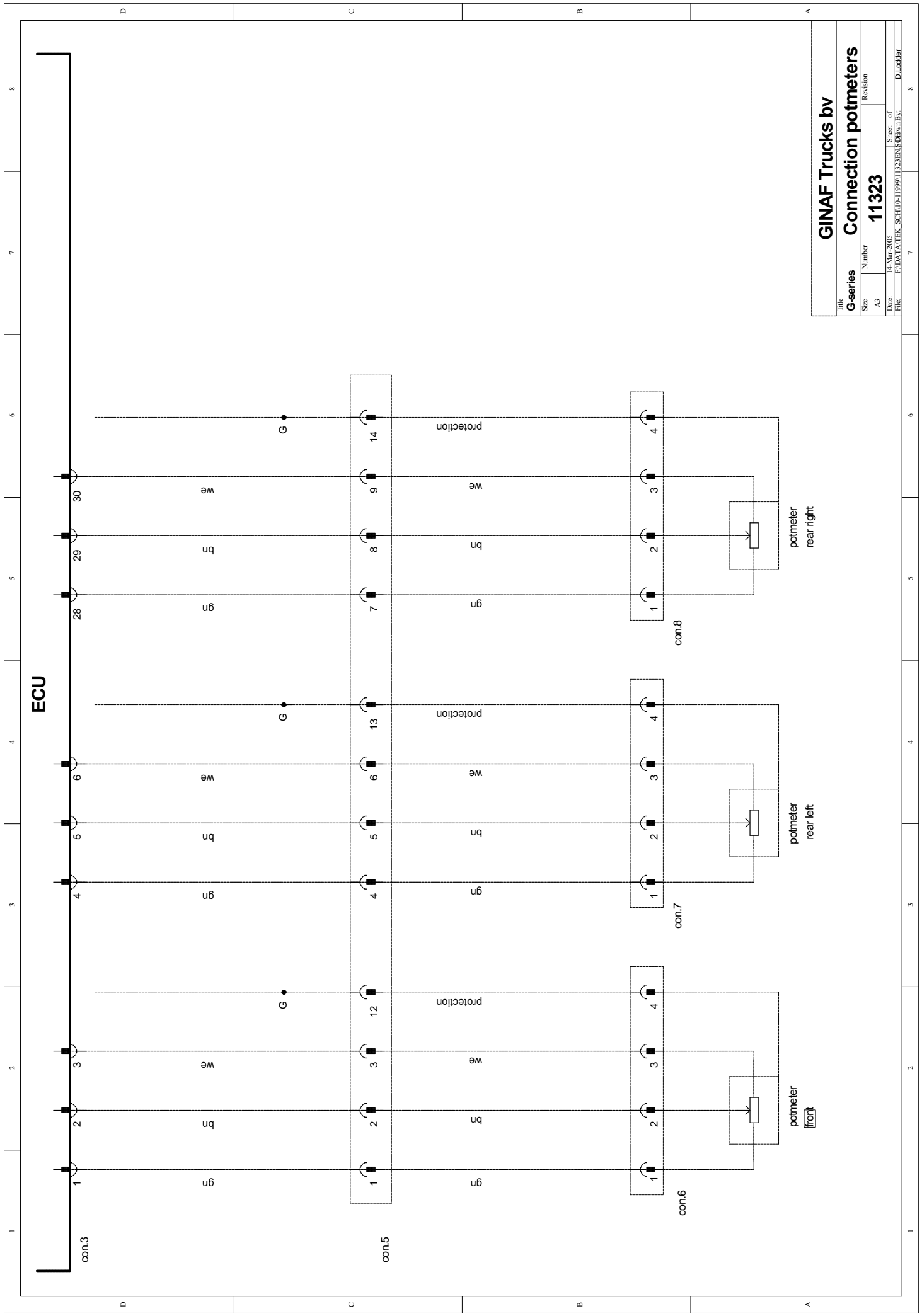

GINAF Trucks bv			
Title	G-series Connection potmeters		
Size	Number	Revision	
A3	11323		
Date:	14-Mar-2005	Sheet of	8
File:	F:\DATA\VEK_SCHU\11323\EN\SCHUWV.BV	Drawn by:	D.Lodder

Diagram 11324/00

Connection to height control system

Switch	Description
B 1	Proximity switch for inflating, left
B 2	Proximity switch for draining, left
B 3	Proximity switch for inflating, right
B 4	Proximity switch for draining, right
B 5	Proximity switch for draining, left, for container lifting system. If a lifting axle is fitted, this switch is used for checking the lifting axle
B 6	Proximity switch for draining, right, for container lifting system.

Connector	No. of pins	Shape	Position
Con. 2	37 bk	round	ECU
Con. 4	39 bk	round	Behind bulkhead on co-driver's side
Con. 9	4 bk	round	Inside of chassis on left near 1st tandem axle
Con. 10	4 bk	round	Inside of chassis on right near 1st tandem axle
Con. 11	4 bk	round	In trlr tow bar

G = Central earthing point, cab behind bulkhead, co-driver's side

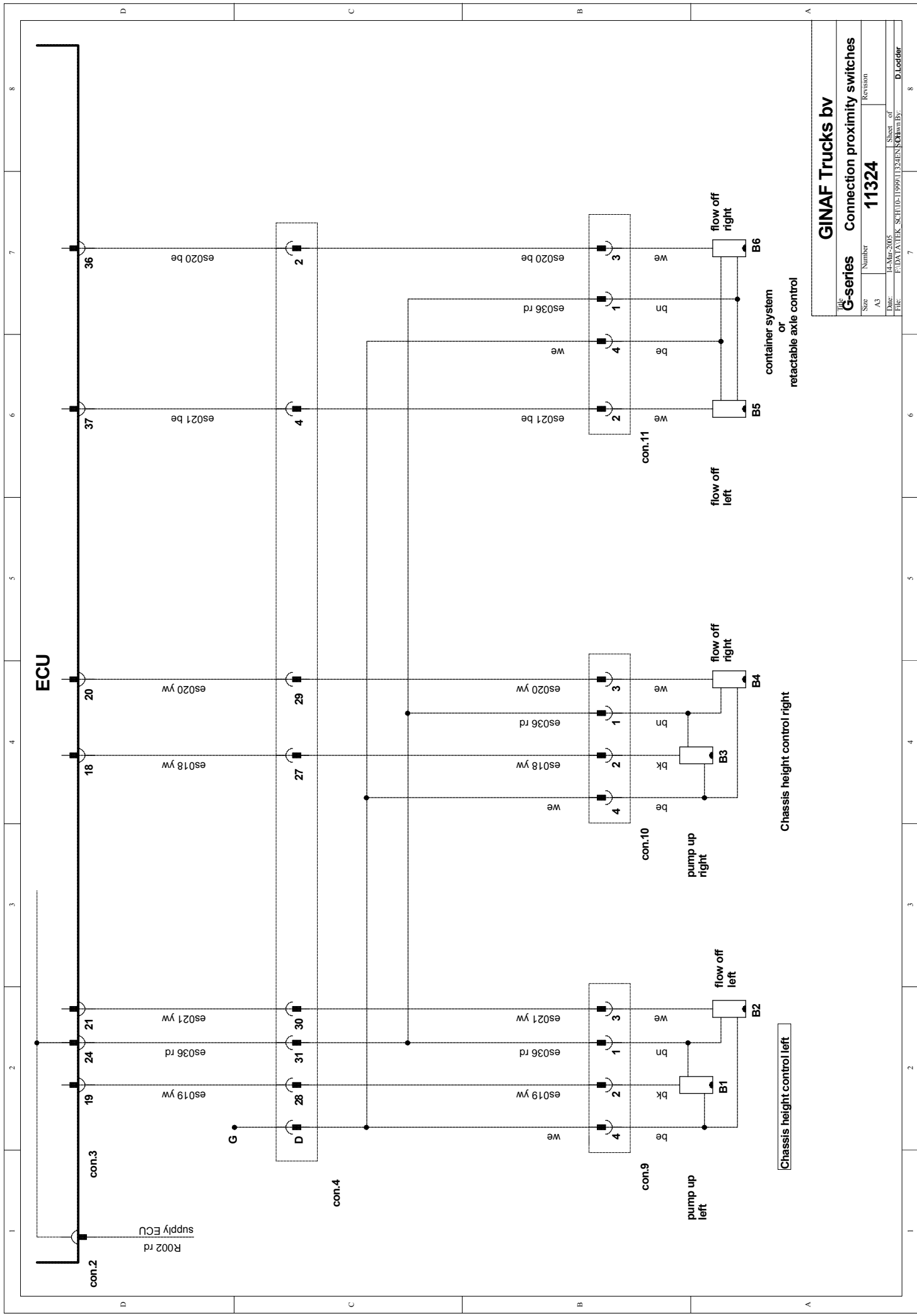

Title		GINAF Trucks bv	
Size	Number	Revision	
A3	11324		
Date:	14-Mar-2005	Sheet of	
File:	F:\DATA\VEK_SCHU\11324\11324EN.SCHW\Bv	D.Lordar	

Diagram 11325/00

Connection to switches (switches in dashboard)

Switch	Description
S 1	Switch for highest position (1) and lowest position (7)
S 2	Switch for driving position (7) and lateral levelling control (1)
S 3	Switch for raising lifting axle (1) and lowering lifting axle (7)
S 4	Switch for container lifting system
S 5	Switch for lateral stabilisation
S 6	Switch for EVS on/off

Connector	No. of pins	Shape	Position
Con. 3	37 bk	round	ECU

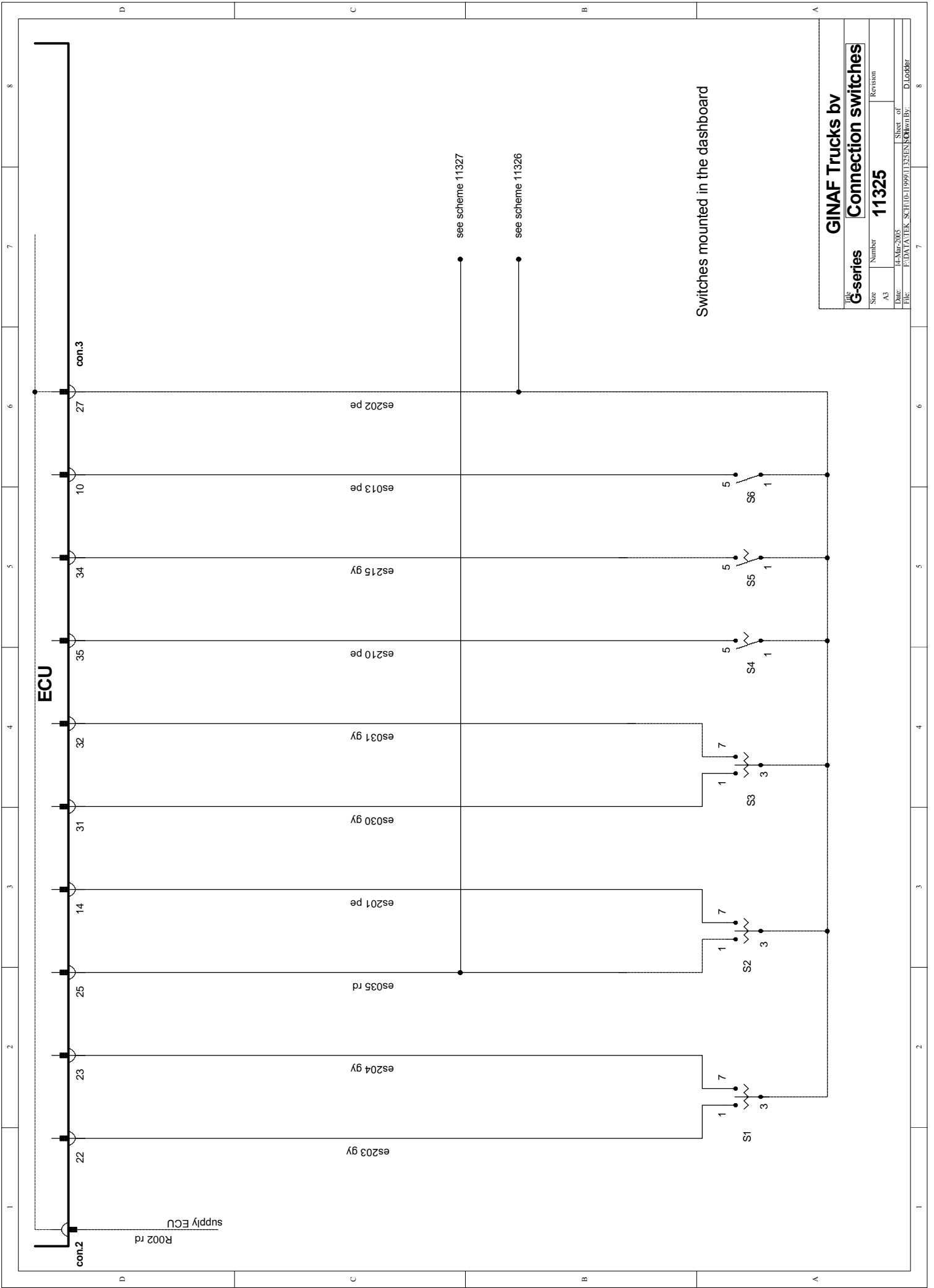

Switches mounted in the dashboard

GINAF Trucks by		
File	G-series Connection switches	
Size	Number	Revision
A3	11325	
Date:	14-Mar-2005	Sheet of
File:	F:\DATA\TEK_SCH\10-1999\11325\KAWA.DB	Drawn by:
		D. Lochter

Diagram 13369/00

Connection to switches (separate control panel, version from 1995)

Switch	Description
S 1	Switch for highest position
S 2	Switch for lowest position
S 3	Switch for driving position
S 4	Switch for lateral levelling control
S 5	Switch for raising lifting axle
S 6	Switch for lowering lifting axle
S 7	Switch for container lifting system
S 8	Switch for lateral stabilisation
S 9	Switch for EVS on/off

Connector	No. of pins	Shape	Position
Con. 2	37 bk	round	ECU
Con. 3	37 bk	round	ECU
Con. 12	20 we	rectangular	Behind CWS (panel with warning symbols in dashboard)

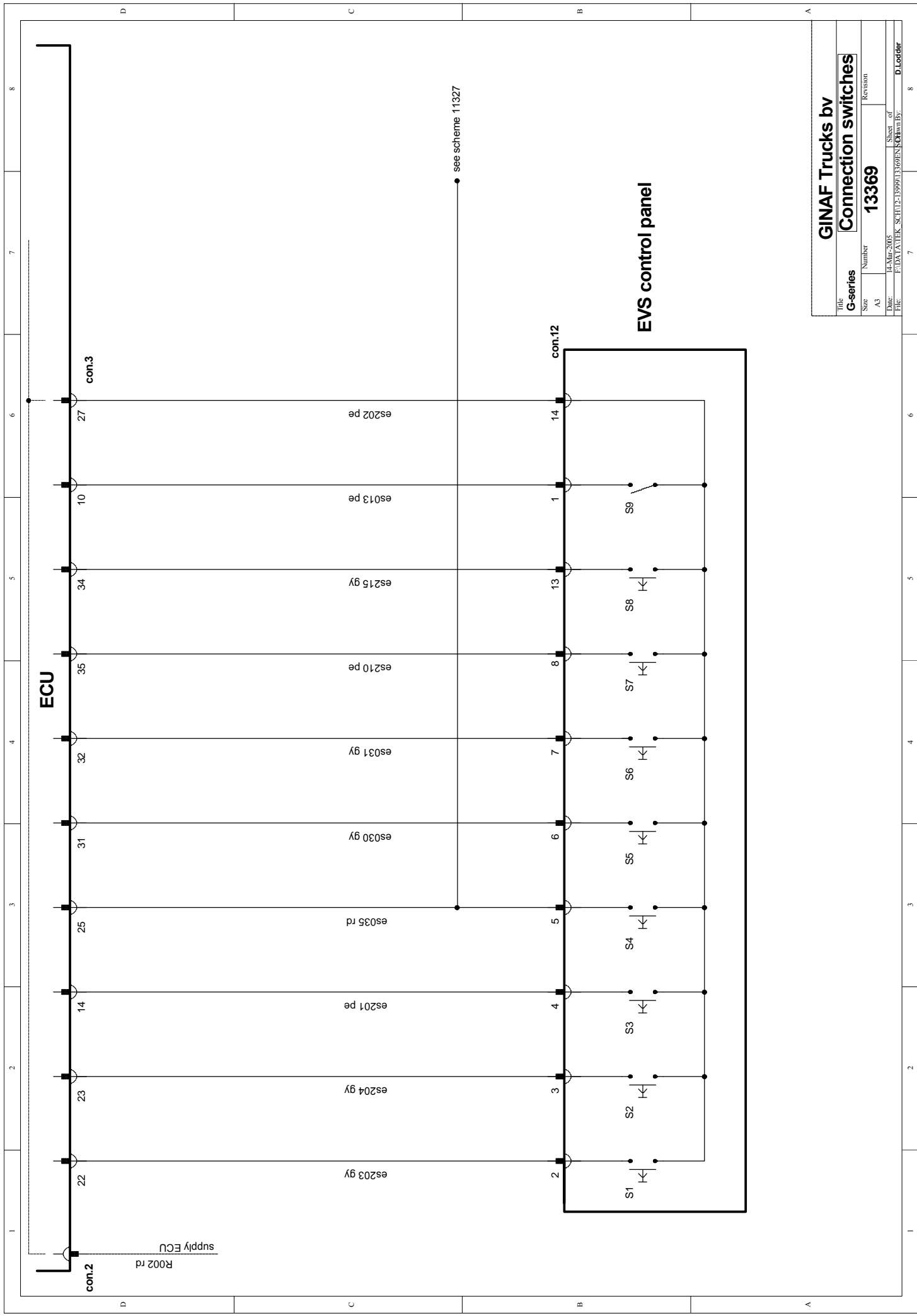

Title		GINAF Trucks by	
Size		Connection switches	
Date		13369	
Revision		Revision	
Sheet of		Sheet of	
D.Lodder		D.Lodder	

Diagram 11326/00

Connection to warning lamps (warning lamps in dashboard)

Lamp	Description
L 1	Warning lamp indicating HPVS/EVS fault message
L 2	Warning lamp indicating oil level too low
L 3	Warning lamp indicating left side of vehicle too low
L 4	Warning lamp indicating right side of vehicle too low
L 5	Lifting axle warning lamp
L 6	Lateral stabilisation warning lamp
L 7	Nightlight switches on control panel
L 8	Warning lamp for pressure filter
Buzzer	Alarm signal

Connector	No. of pins	Shape	Position
Con. 2	37 bk	round	ECU
Con. 3	37 bk	round	ECU
Con. 4	39 bk	round	Behind bulkhead on co-driver's side
Con. 14	15 we	rectangular	On fuse panel, position 205
VL			Nightlight connection connected to cigar lighter
Buzzer		round/red	On hand brake support

G = Central earthing point, cab behind bulkhead, co-driver's side

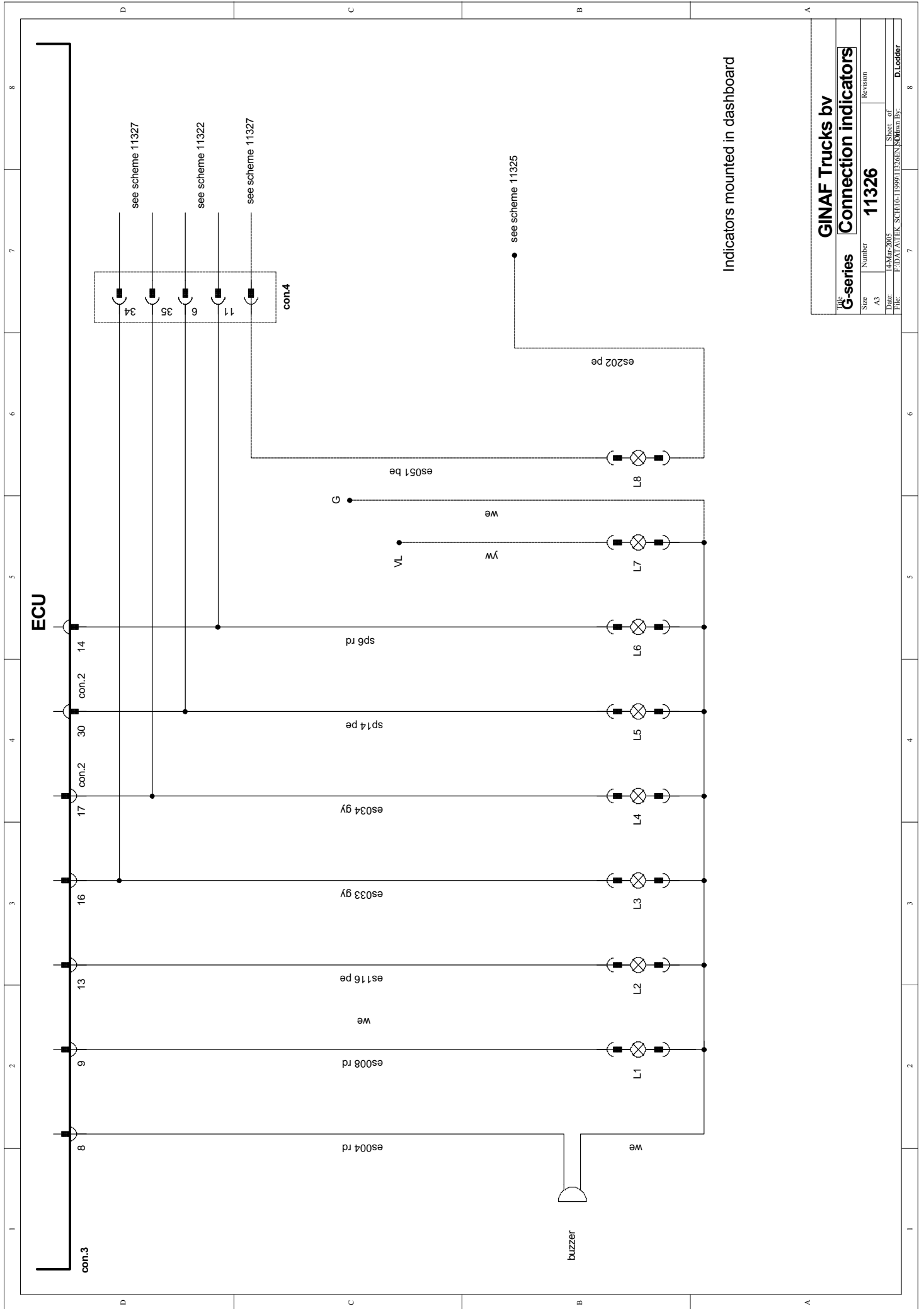

Indicators mounted in dashboard

GINAF Trucks by	
G-series	Connection indicators
Size	Revision
A3	
Date:	Sheet of
File:	Number of
F:\DATA\TEK_SCH\10-11999\11326\IN	D.Lodder

Diagram 13370/00

Connection to warning lamps (separate control panel, version from 1995)

Lamp	Description
L 1	Warning lamp indicating HPVS/EVS fault message
L 2	Warning lamp indicating oil level too low
L 3	Warning lamp indicating left side of vehicle too low
L 4	Warning lamp indicating right side of vehicle too low
L 5	Lifting axle warning lamp
L 6	Lateral stabilisation warning lamp
Buzzer	Alarm signal

Connector	No. of pins	Shape	Position
Con. 2	37 bk	round	ECU
Con. 3	37 bk	round	ECU
Con. 4	39 bk	round	Behind bulkhead on co-driver's side
Con. 13	20 we	rectangular	Behind CWS (panel with warning symbols in dashboard)
Con. 14	15 we	rectangular	On fuse panel, position 205
Buzzer		round/red	In fuse box

G = Central earthing point, cab behind bulkhead, co-driver's side

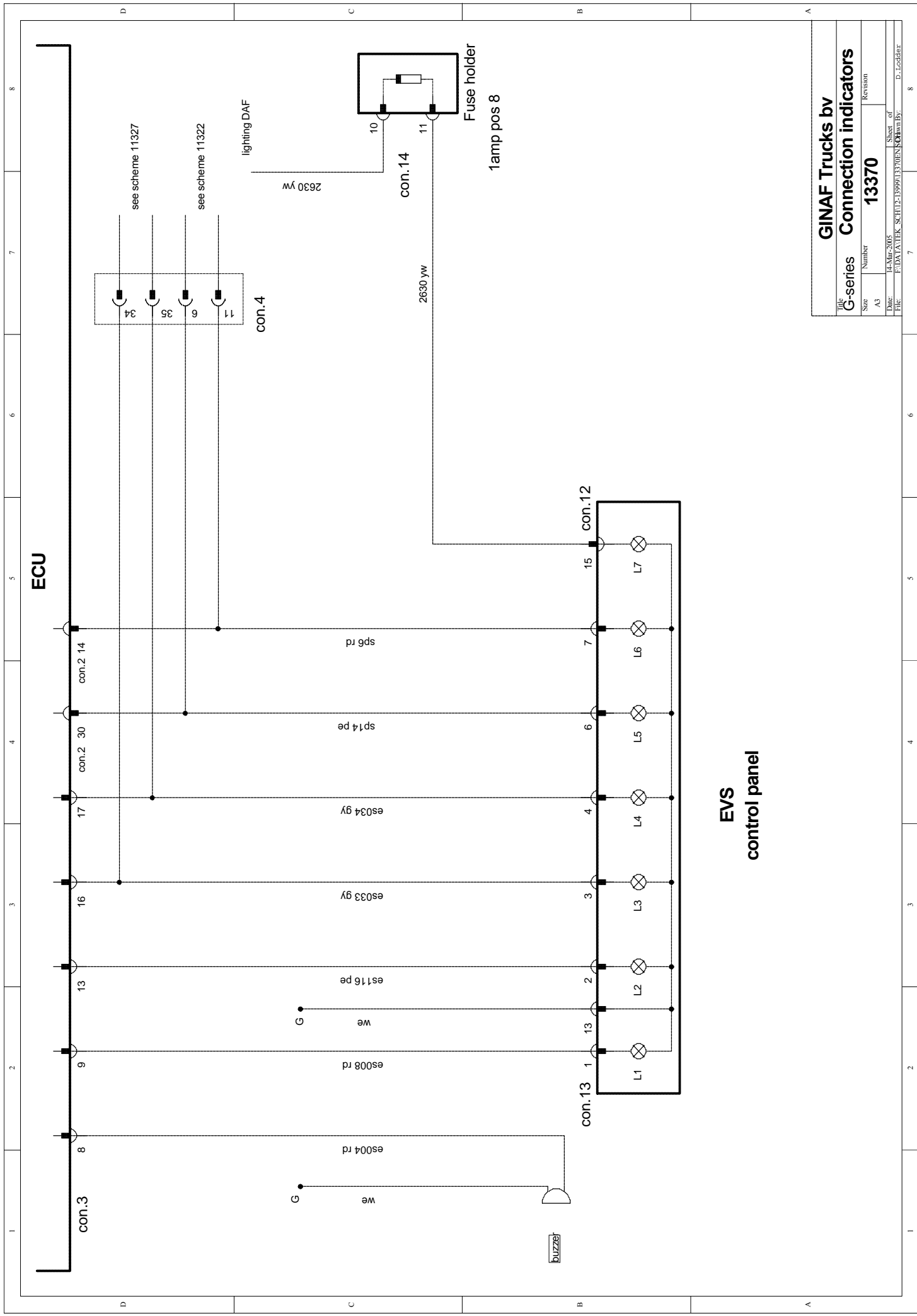

GINAF Trucks by			
Title		Connection indicators	
Size	Number	Revision	
A3	13370		
Date	Sheet of		
14-Mar-2005	1		
File	Path	D. Ledger	
F:\DATA\VEK_SCH\12-1899013370\K13370\B1			

Diagram 11327/00

Connection to lateral levelling control system, pressure switches, oil level, flow indicator and tachograph

Switch	Description
--------	-------------

S 10	Pressure switch, emergency steering system
------	--

S 11	Switch for oil level or flow indicator
------	--

W.p.d.reg	Sensor for lateral levelling control
-----------	--------------------------------------

Connector	No. of pins	Shape	Position
Con. 3	37 bk	round	ECU
Con. 4	39 bk	round	Behind bulkhead on co-driver's side
Con. 15	4 rd	round	In trlr tow bar
Con. 16	20 we	rectangular	In fuse box

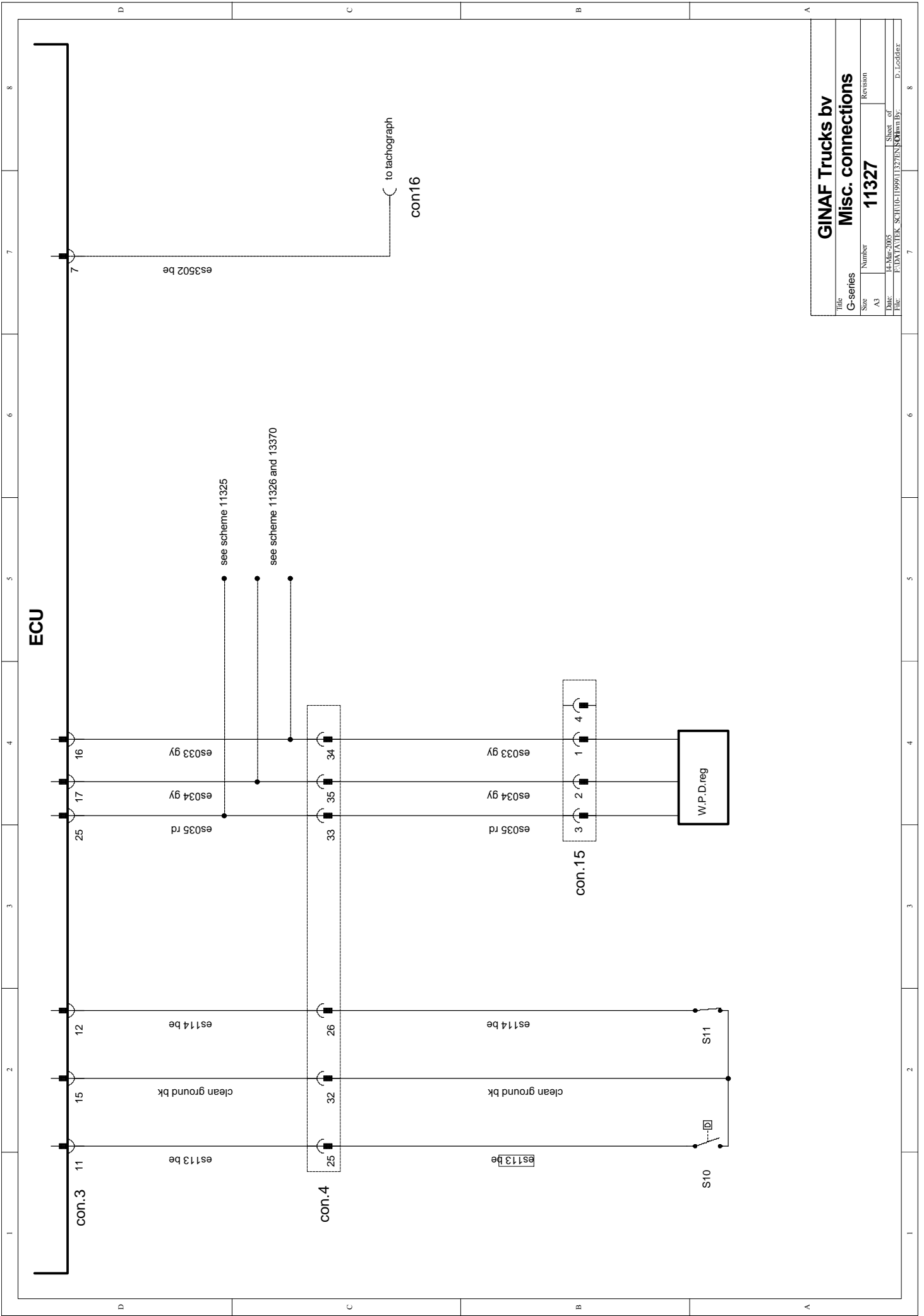

Title		GINAF Trucks by	
G-series		Misc. connections	
Size	Number	Revision	
A3	11327		
Date:	14-Mar-2005	Sheet of	
File:	F:\DATA\TEK_SCH\11327\EN\SCH\HW1.BY	D. Lodder	

Diagram 11328/01

Power supply to ECU

Comp.	Description
Z 1	Fuse for ECU internal circuit and for power supply to switches and proximity switches
Z 2	Fuse for coils
Z 3	Fuse for heating element
rd	DAF contact relay

Connector	No. of pins	Shape	Position
Con. 2	37 bk	round	ECU

G = Central earthing point, cab behind bulkhead, co-driver's side

Diagram 11329/01

Power supply to ECU with lifting axle

Lamp	Description
Z 1	Fuse for ECU internal circuit and for power supply to switches and proximity switches
Z 2	Fuse for coils
Z 3	Fuse for heating element
D 1	Single diode
R 1	Changeover relay
R 2	Changeover relay
R 3	Changeover relay
L 2	Lifting axle warning lamp

(D 1 and R 1 to R 3 are fitted in the fuse box)

Connector	No. of pins	Shape	Position
Con. 2	37 bk	round	ECU
Con. 3	37 bk	round	ECU
Con. 4	39 bk	round	Behind bulkhead on co-driver's side

G = Central earthing point, cab behind bulkhead, co-driver's side

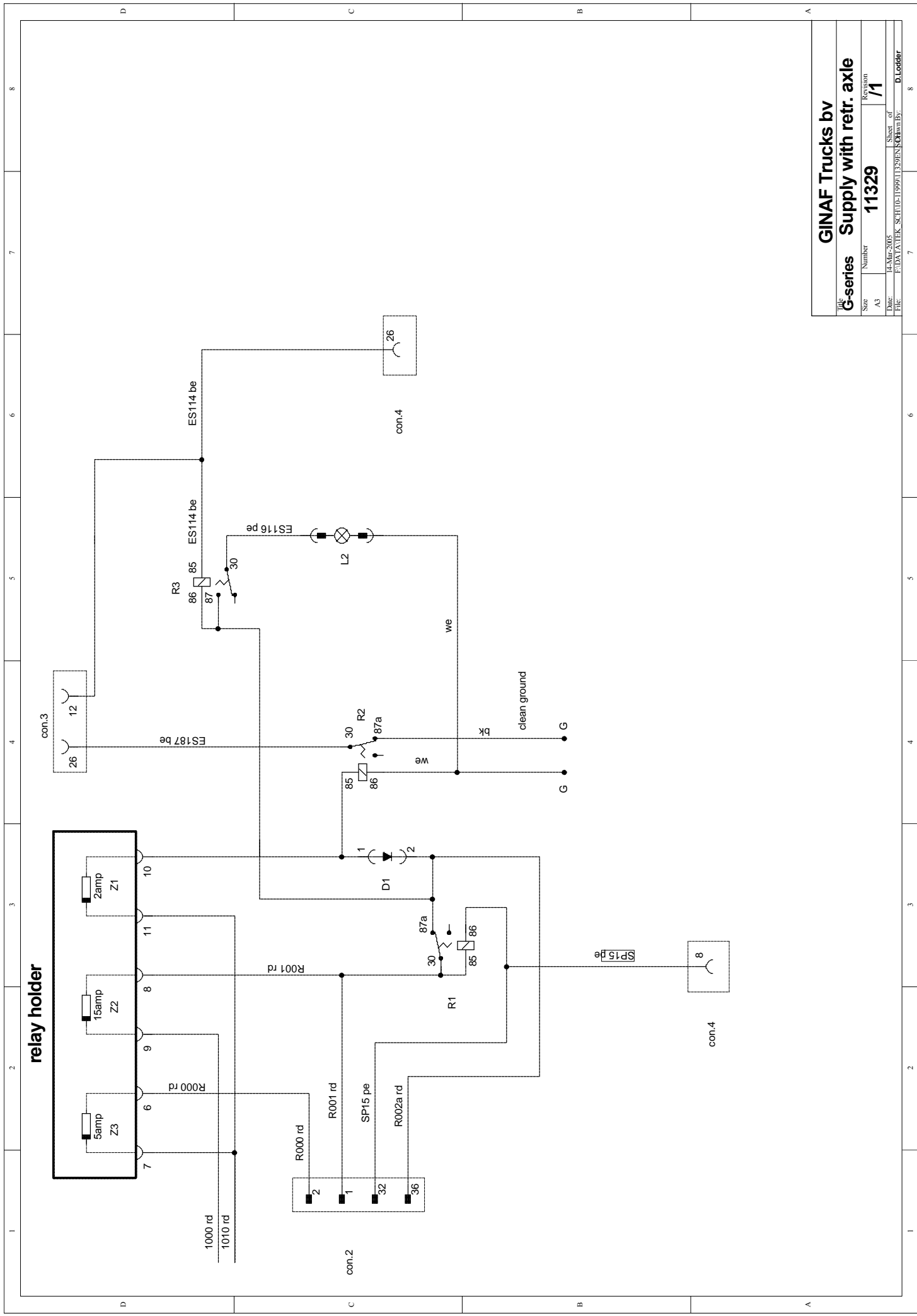

Title		GINAF Trucks by	
Size		Supply with retr. axle	
A3	Number	11329	Revision
			/1
Date:	14-Mar-2005	Sheet of	
File:	F:\DATA\VEK_SCH\1011329\EN\SCH\wv1.bv	Drawn by:	D.Lodder

Diagram 13371/00

Power supply to ECU (version from 1995)

Comp.	Description
Z 1	Fuse for heating element
Z 2	Fuse for ECU internal circuit and for power supply to switches and proximity switches
Z 3	Fuse for coils
rd	DAF contact relay

Connector	No. of pins	Shape	Position
Con. 2	37 bk	round	ECU
Con. 14	15 we	rectangular	On fuse panel, position 205

G = Central earthing point, cab behind bulkhead, co-driver's side

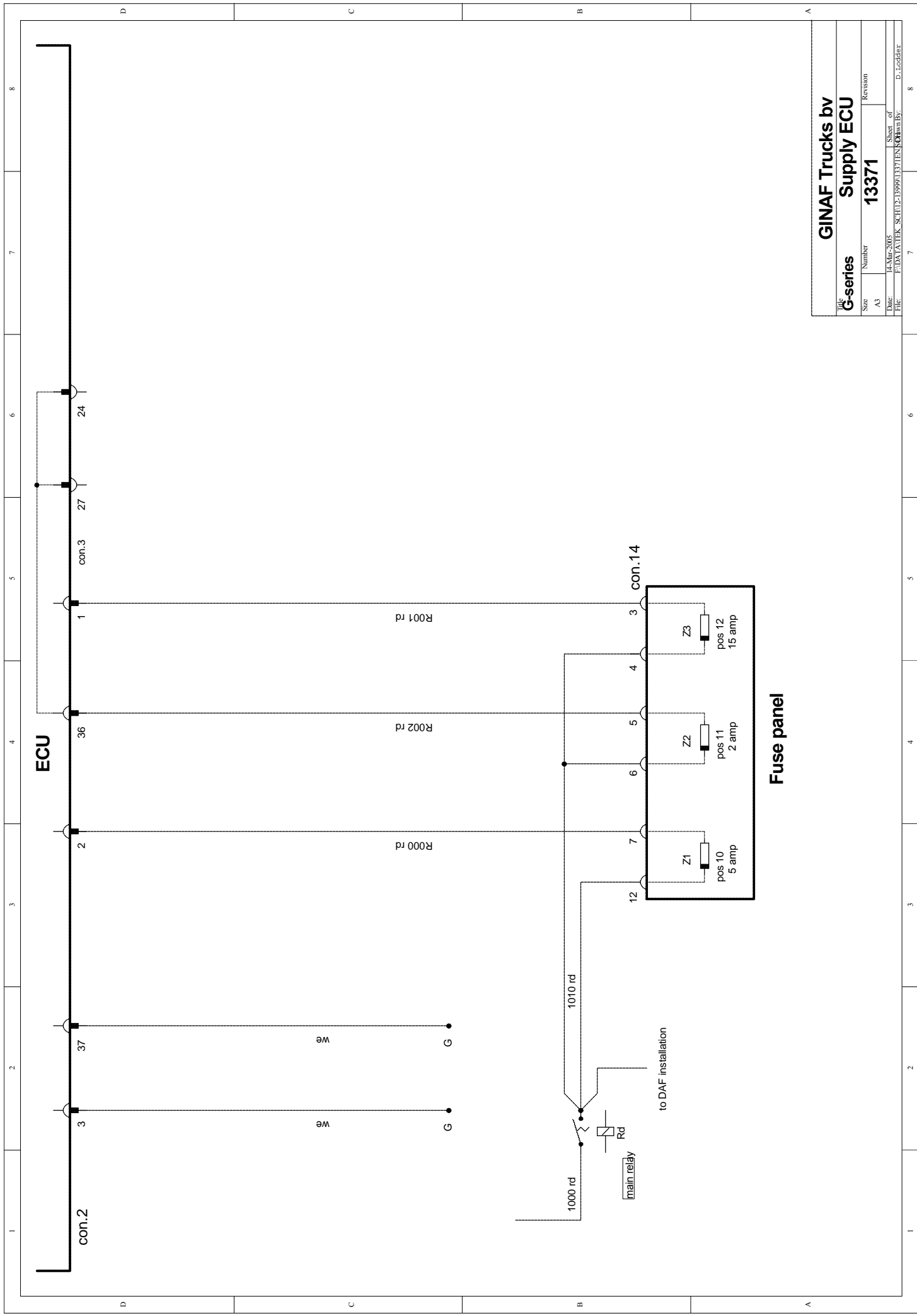

GINAF Trucks by Supply ECU			
Title G-series		Revision	
Size A3	Number 13371		
Date 14-Mar-2005	Sheet of 1		
File P:\DATA\TEK_SCH\12-1399\013371EN\SCH\w1.BV	Drawn By D. Ledger		

Diagram 13372/00

Power supply to ECU with lifting axle (version from 1995)

Lamp	Description
Z 1	Fuse for heating element
Z 2	Fuse for ECU internal circuit and for power supply to switches and proximity switches
Z 3	Fuse for coils
D 1	Single diode
R 1	Changeover relay
R 2	Changeover relay
R 3	Changeover relay

Connector	No. of pins	Shape	Position
Con. 2	37 bk	round	ECU
Con. 3	37 bk	round	ECU
Con. 4	39 bk	round	Behind bulkhead on co-driver's side
Con. 12	20 we	rectangular	Behind CWS (panel with warning symbols in dashboard)
Con. 14	15 we	rectangular	On fuse panel, position 205

G = Central earthing point, cab behind bulkhead, co-driver's side

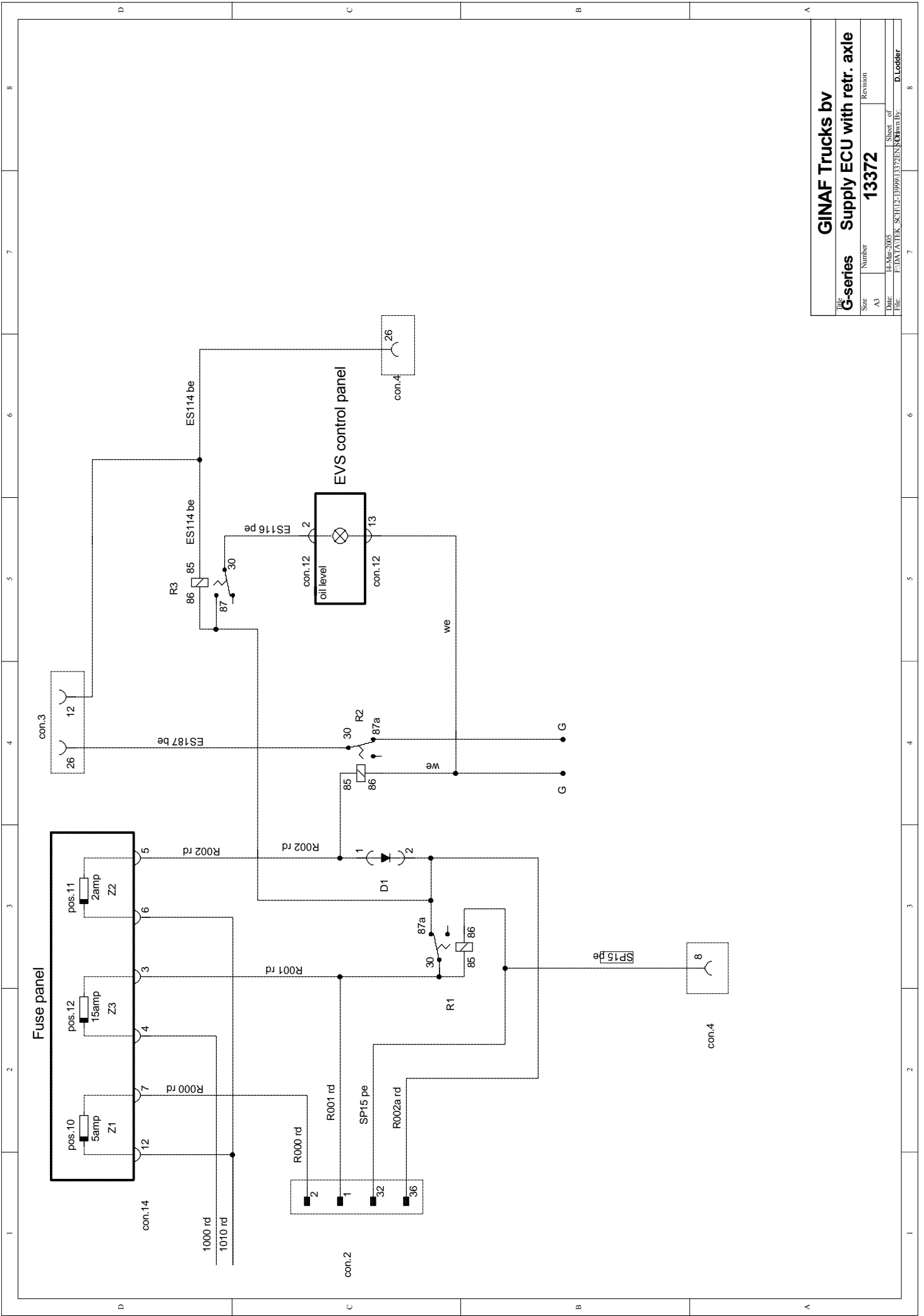

Title			
GINAF Trucks by			
G-series		Supply ECU with retr. axle	
Size	Number	Revision	
A3	13372		
Date:	14-Mar-2005	Sheet of	
File:	F:\DATA\VEK_SCH\12-1399\013372\EN\SCH\wv.BV	Drawn by:	D.Lodder

Diagram 13128/00

Connection to container lifting system (vehicle with lifting axle)

The relays are located in the fuse panel.

Diode D1 is located in the control panel.

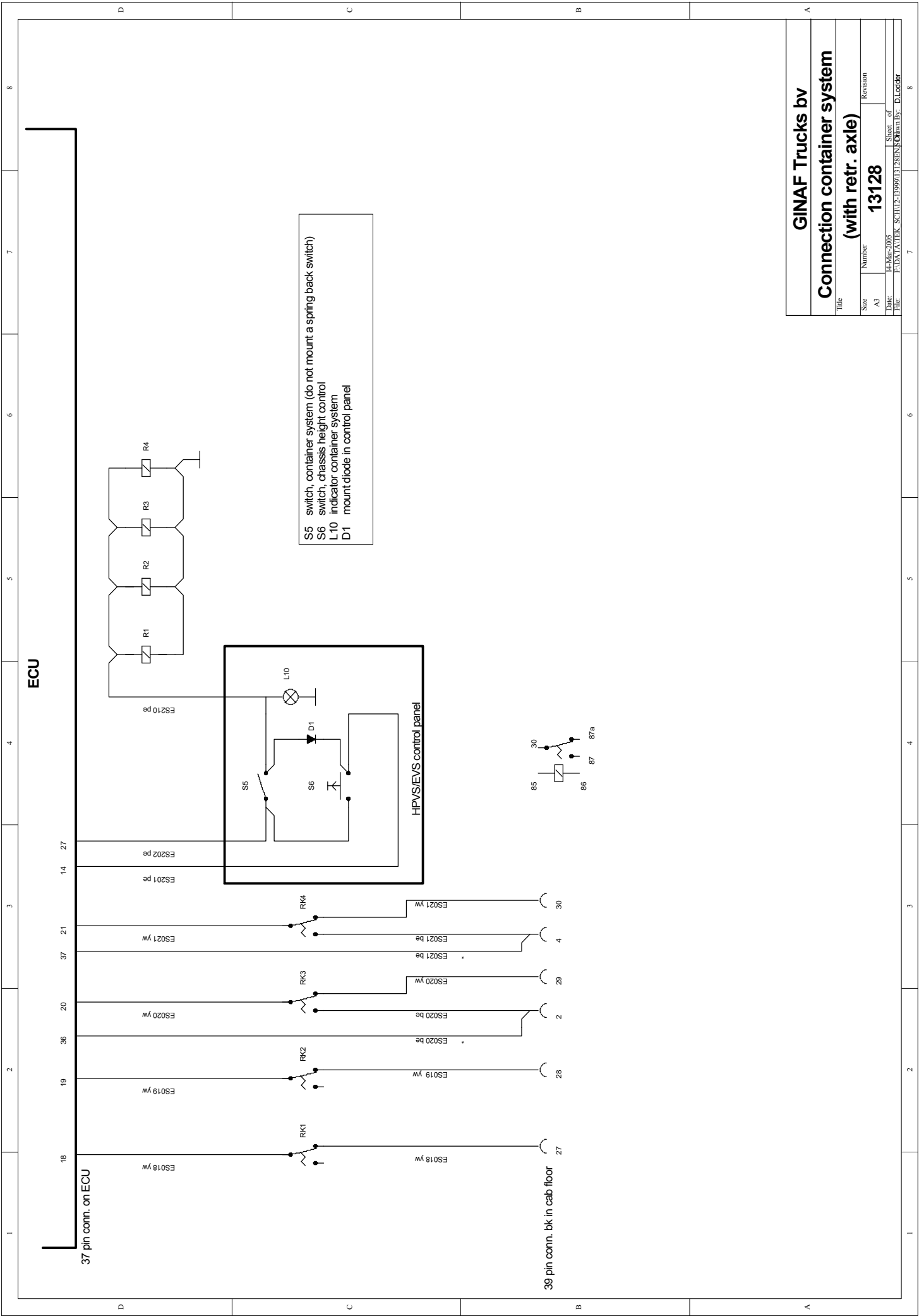

GINAF Trucks by	
Connection container system	
(with retr. axle)	
Title	Revision
Size	Number
A3	13128
Date: 14-Mar-2005	Sheet of
File: F:\DATA\VEK_SCH\12-13999\01328\EN\SCH\wv1.bv	D.Lodder