

AVANT[®]

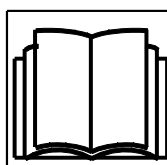

Operator's Manual 2017-



Read this Operator's Manual, safety decals, and other safety related instructions before operating the loader. If you do not obey these instructions, there is a risk of serious injury. Keep all manuals for reference.

TABLE OF CONTENTS

INTRODUCTION	3	Options	39
Foreword	3	OPERATING INSTRUCTIONS	43
Make sure all relevant manuals are available.....	4	Starting the loader	44
Intended use	5	Ignition key.....	44
Avant warranty	7	Battery disconnect switch.....	45
SAFETY FIRST	8	Stopping the loader (Safe stopping procedure).....	45
General safety instructions.....	8	Drive control.....	46
Operation on uneven surfaces, gradients, and near excavations	11	Material handling.....	50
Personal safety and protective equipment.....	12	In case the machine tips over.....	52
Electric system and handling of the battery pack.....	14	Transport instructions and tie down points	53
DESCRIPTION OF THE LOADER	17	Lifting.....	54
Identification of the loader	17	Storage	55
Main parts of the loader	18	WORKING WITH ATTACHMENTS	56
Signs and decals	19	Requirements for attachments	56
Technical specifications	22	Coupling the attachments	57
General specifications	23	Coupling the hydraulic hoses of the attachment	60
Auxiliary hydraulics oil flow	24	Using the auxiliary hydraulics.....	61
Tyres.....	25	Releasing the residual pressure of hydraulic system	62
Wheel spacers	25	BATTERY AND CHARGING	63
Tipping load	27	Charging the battery.....	65
Tipping load - load chart	28	Charger plug type.....	66
Rated operating capacity	29	Battery maintenance - water refill	68
CONTROLS AND OPTIONS OF THE LOADER	30	Watering procedure.....	69
Dashboard.....	31	SERVICE AND MAINTENANCE	70
Control of loader boom, auxiliary hydraulics and other functions	32	Access to electric motor compartment.....	71
Parking brake switch	35	Installing of service support and frame lock.....	72
Multi-function display	35	Daily inspections.....	73
Electric 12 V outlet.....	35	Maintenance schedule	75
Seat - Seat belt and seat adjustments.....	36	Loader maintenance	76
Seat heater	36	Battery maintenance.....	82
Lights	37	Electric system & fuses	85
CAB L (optional extra).....	38	TROUBLESHOOT	87
		SERVICES MADE	89
		INDEX	94

Introduction

Foreword

AVANT TECNO OY wants to thank you for purchasing this fully electrically powered AVANT loader. It represents a new level of quiet operation with no local emissions and low operating costs. The battery powered model line is designed and built upon Avant's long experience with compact loaders and is manufactured in Finland. We ask you that you read and understand the contents of this manual completely before operating the loader. This operator's manual is intended to help you to:

- operate this machine safely and efficiently
- observe and prevent situations that may cause a risk or danger
- keep the machine in good condition and its life span as long as possible

The following warning symbols are used throughout this manual to indicate factors that must be considered to reduce the risk of personal injury or damage to property:

	<p>WARNING:</p>
	<p>This safety symbol refers to important safety information in this manual. It warns of an immediate hazard that could cause serious personal injury.</p> <p>Read the warning text accompanying the symbol carefully and ensure that other operators are also familiar with the warnings, since personal safety is at stake.</p>

DANGER: This signal word indicates a hazardous situation which, if not avoided, will cause death or serious injury.

WARNING: This signal word indicates a potentially hazardous situation which, if not avoided, could cause serious injury or death.

CAUTION This signal word is used when minor injury could result if the instructions are not followed properly.

NOTICE This signal word indicates information about the correct operation and maintenance of the equipment.

Failure to observe the instructions accompanying the symbol can lead to equipment breakdown or other property damage.

Make sure all relevant manuals are available



Wrong use of the equipment can cause death or severe injuries - Make sure to read all relevant manuals and instructions thoroughly and keep them available for all operators.

Using each attachment requires specific information about correct use, mounting procedure, safety, and how to avoid hazardous situations. An attachment may introduce risks that are not present when operating the loader with other kinds of attachments. Always read the operator's manual of each attachment carefully.

Manuals of attachments



Attachments can create significant risks that are not covered by this Operator's manual of the loader.

Make sure you have all attachments manual available. Wrong use of an attachment can cause serious injuries or death.

Each attachment is accompanied by its own respective Operator's Manual. The manual will show important information related to safety, and how to attach, use, and maintain each attachment correctly.

Spare parts list



All spare parts of the loader are listed in a separate spare parts list.

Contact your Avant service partner or dealer to order parts. Have the serial number of the loader available when ordering to ensure correct parts.

Intended use

The Avant eSeries loaders are battery powered, hydraulically operated, articulated compact loaders. They are designed and manufactured for both private and professional use. The loader can be equipped with a range of attachments offered by Avant Tecno Oy, which enables you to do several different jobs with the same machine. Because of this multi-purpose nature of the machine and the various attachments and tasks, read always not only this Manual but also the Operator's Manual of the attachment, and follow all instructions. Every person who deals with this machine must follow work safety regulations, all other generally accepted rules related to work health and safety, and all road traffic regulations.

Remember that safety consists of several factors. The loader, by itself or equipped with an attachment, is very powerful and can cause serious personal injuries or property damages if it is operated in a wrong or careless way. Never allow the compact size of the loader to distract from this fact and keep it in mind when you consider to allow another user to operate it. Do not operate an attachment unless you have familiarised yourself with the use of it and the eventual dangers and risks related to it. Take the keys with you when you leave the loader unattended to prevent other, unfamiliar persons to operate the machine. The loader is not intended to lift or transport people or be used as a work platform. Different jobs require different attachments, and it is not allowed to handle any material or loads without any attachment fitted.

This loader has been designed to need as little maintenance as possible. The operator can perform the routine maintenance operations. There are however more demanding service operations that can be done by professional service personnel only. Wear appropriate protective equipment when you do any service or maintenance work. Original spare parts must be used. Familiarise yourself with the service and maintenance instructions in this Manual. Operating a loader that is in poor condition, or that has received unauthorised modifications, can be hazardous to the operator and bystanders.

Contact your local AVANT dealer, if you are uncertain of anything concerning the operation and maintenance of this loader, or for any questions, service, or spare parts.

In addition to the safety instructions included in this manual, you must observe all occupational safety regulations, local laws, and other regulations concerning the use of the equipment. Particularly the regulations concerning the use of the equipment on public road areas must be observed. Contact your Avant dealer for more information about local requirements before you operate the loader on road areas.

This loader has been designed to require as little maintenance as possible. The operator can perform the routine maintenance tasks. There are however more demanding service operations that must be done by professional service personnel only. It is allowed to perform service operations only when wearing appropriate protective equipment. Original spare parts must be used. Familiarise yourself with the service and maintenance instructions in this Manual. Operating a loader that is in poor condition, or that has received unauthorised modifications, can be hazardous to the operator and bystanders.

Battery operated e5

Ambient temperature will limit the energy that is available from the batteries. Battery performance may decrease significantly at temperatures below 0°C (32°F) and batteries can be discharged more quickly. Charging of the loader is not recommended at temperatures below 0°C (32°F). Discharged batteries may freeze in cold environment and frozen batteries must never be charged. See instructions in this manual regarding operating environment, charging, and safety of battery systems

The loader is designed to operate with the battery pack supplied with the loader and approved by the manufacturer. The battery pack must be charged only with the charger provided with the loader, or other charging system supplied by Avant for this loader model. Using any other batteries or chargers can cause fire or explosion of batteries and risk of electric shock.

Maintenance tasks that you can do to this system without special training and qualification are limited to charging, water fill, cleaning, replacement of fuse. Never connect any device directly to the battery.

Operator qualification

Only operators who have studied this manual, and all relevant attachment manuals, are allowed to use this loader. Regardless of your possible previous experience with lawn-mowers, loaders, ATVs, or other equipment, it is important that you learn the driving principle of this loader. Practise how to operate the loader and its attachments safely at an open area before you use the loader near other persons.

You must be in good physical and mental condition with the ability to stay alert and to observe the surrounding area. Never use the equipment while under influence of medication which could impair your abilities to operate the equipment safely. Do not operate the loader if you are under the influence of alcohol or any other intoxicant during the work shift.

Depending on operating area, you may also be required to read, understand and comply with all applicable Employer, Industry and Governmental rules, standards and regulations.

Electric qualification

You can replace the battery pack with a similar one supplied by the manufacturer. Other battery or electric related maintenance that is not shown in this manual, is prohibited. Leave all electric parts from the battery connector forward to authorised service professionals to avoid risk of electric shock, fire, and short-circuiting and explosion of battery. High-voltage cables and connectors, inverter, and electric motors do not have components that can be maintained by user.

Versions of this manual

Avant has a policy on continuous product development. Updated versions of the manual replace the previous versions of this manual as long as the year on the cover page matches with the original manual. You can ask for the latest manual from your dealer. Some of the features or technical details presented in this manual may change without notice. The pictures in this manual may show optional equipment or features that are not currently available in your market area. We reserve the right to change the contents of the manual without notification.

Keep this manual with the loader



Read this manual before use. Put this manual, as well as manuals of attachments, into the storage box behind driver's seat when you have read those. Always keep this Operator's Manual with the loader. If this Manual gets lost, ask for a new copy from your Avant dealer. Also remember to give this Manual to the new owner when the machine changes ownership.

Avant warranty

This warranty specifically applies to the Avant e5 loader only and not to any attachments used with this product. The battery is covered by special warranty clauses listed below. Any repairs or modifications performed without the prior authorisation of Avant Tecno Oy will cancel this warranty. During the first *two years of operation or first 1000 hours* (whichever is the soonest) Avant Tecno Oy warrants to replace any part or repair any defect which may occur, subject to the terms detailed below:

1. The product has received regular maintenance in accordance with schedules given by the manufacturer.
2. Any damage caused by operation in a negligent manner or exceeding the approved specifications detailed in this manual is excluded.
3. Avant Tecno Oy accepts no responsibility for interruption to working or any other consequential losses resulting from any failure of the product.
4. Only Avant Tecno Oy approved replacement or original quality parts shall be used during routine maintenance.
5. Any damage caused by the use of incorrect fuel, lubricants, cooling liquid, or cleaning solvents is excluded.
6. The Avant Warranty excludes any consumable parts (e.g. tyres, batteries, filters, belts etc.) except where it can be clearly shown that these parts were defective on original supply.
7. Any damage caused resulting from the use of attachments not approved for use with this product is excluded.
8. The battery must be used, recharged, and maintained as instructed in this manual. Damages caused by neglected maintenance or repeated deep discharge cycles are not covered by the warranty. See warranty period for battery below.
9. In the event a fault occurs which is attributable to manufacturing or assembly defect you should arrange to return your AVANT to your authorised dealer for repair. Travel and freight costs are excluded.

Special warranty terms regarding the battery

During the first year of use, battery is under full warranty covering parts regarding the battery. After the first year and until the end of second year (months 13 to 24) the battery is under partial warranty. During this 13 to 24 month term warranty coverage is calculated by the age of the battery, and the cover declines by the operation age of the battery. The responsibility of the customer regarding parts and material costs of the battery starts from month 13 of the warranty period at 13/24 parts of the full cost of replaced parts, ending at full 24/24 at the end of the warranty period.

Safety First



DANGER

Incorrect or careless operation of the loader may cause a serious accident. Before you operate the machine, familiarise yourself with the use of the machine and read and understand this Operator's Manual, as well as all relevant safety instructions, local regulations, and safe working practices.

Understand the limitations of speed, braking, steering and stability as well as loading capacity of the machine before starting operation. Make sure that everyone who operates or works with this equipment is familiar with these safety precautions.

If you have no previous experience of the machine, make sure to do all testing at a safe and open place with no persons in the area of operation.

General safety instructions

1. Remember the correct working position. When driving, be comfortably seated in the driver's seat, keep your feet in their proper place in the footwell and at least one hand on the steering wheel.
2. When seated, always keep the seat belt fastened and keep hands and feet inside the operator's area.
3. Before leaving driver's seat, always:
 - Lower the loader boom and place attachment flat on ground
 - Relieve residual hydraulic pressure (see page 62)
 - Engage the parking brake
 - Switch off the electric motors, remove the ignition key
4. Start the operation slowly and carefully. Practise driving of the machine at a safe and open place before connecting any attachment, and follow the instructions in this Manual and also the operator's manual of the attachment.
5. Operate the control levers with careful and deliberate movements. Avoid abrupt movements when handling the load, in order to prevent the load from falling and to keep the machine stable.
6. Keep away from the danger zone of the lifted boom and don't let anyone go there.
7. Keep your hands, feet and clothing away from all moving parts, hydraulic components, and hot surfaces.
8. Make sure that there is enough open space around the machine for safe driving.
9. Do not transport the load with the boom lifted. Always carry bucket or attachment as low as possible, and put the load down whenever you leave the machine.
10. It is not allowed to transport persons with this machine. Do not transport or lift persons in the bucket or in any other attachment. Lifting of persons is only allowed with the attachment designed for this purpose: the Avant Leguan 50 access platform, following the instructions in the Operator's Manual of Leguan 50 attachment.
11. Do not exceed the tipping load. Familiarise yourself with and follow the load diagrams in this Manual.
12. When turning with the machine, remember that the driver's seat extends beyond the turning radius of the wheels (collision risk).
13. Do not operate the loader in an explosive environment or in a place where dust or/and gases can create a fire or explosion hazard.
14. Keep the areas around the battery, inverter, electric motors, and cooling fan clean of flammable materials.
15. Read the lifting, towing and transportation instructions on page 54.
16. Remove the ignition key from the ignition whenever leaving the machine unattended.

17. Follow all inspection, service and maintenance instructions. If you notice any faults or damages on the machine, these must be repaired before starting operation.
18. Before any maintenance or repair operation always stop and switch off the loader, lower the boom down and release pressure from hydraulic system. Read safety instructions for maintenance on page 70.
19. Do not let any person operate this loader who has not read safety instructions and is not familiar with the safe and correct use of this loader.
20. Never operate the loader or attachments while under the influence of alcohol, drugs, medication that may impair judgement or cause drowsiness, or if not otherwise medically fit to operate the equipment.

**Safety devices are installed for your safety -
Never modify or bypass any safety function**



Safety functions are installed for your safety. Never modify or block any of the safety systems of the loader. If you notice that a system is not in good condition, stop the use of the loader and make sure the is serviced.

**Sudden movements can tip the machine over -
Risk of overturning**



Movements, such as stopping, turning, or lowering the boom abruptly, can cause loss of stability. Always drive slowly and operate the controls of the loader very carefully, especially when handling heavy loads.

Articulated frame - Risk of overturning



Turning articulated frame can lead to overturning of the loader on inclined terrain or when driving at high speed. Never turn frame towards the slope while operating on inclined ground.

Always drive slowly when carrying load or when turning with the machine.

Overload - Risk of overturning



The high lift capacity of the loader makes it possible to exceed the stability of the loader when handling loads. Read the instructions regarding maximum lift capacity and load handling in this Operator's Manual. Following the instructions reduces the risk of tipping the machine over its front axle, but the operator must be aware of the limits of the machine and follow safe working practises to avoid overturning of the machine.



Never take a heavy load on the loader from high level – e.g. from truck, shelf etc. – risk of tipping over!

If the load is too heavy when lifting load from a high level, the loader could tip forward when reversing with the loader.

Never reverse and drag with the loader before you make sure that the loader can handle the load that is being lifted.

When loading, always keep the loader frame as straight as possible.

Falling of load or unexpected lowering of loader boom - Risk of crushing

WARNING



Always remember that the boom may lower unexpectedly due to loss of stability, mechanical fault, or if another person operates the controls of the loader, leading to crushing hazard. The attachment or the loader are not intended to be left to keep a load elevated for longer periods. Lower the attachment before leaving the driver's seat. The stability of the loader may change when leaving the driver's seat, leading to tipping over of the machine.

Risk of falling objects

WARNING



Make sure load is securely on the attachment. Never tilt the attachment back when it is lifted high. Operate only with machines equipped with ROPS and FOPS structures.

Falling of persons - Risk of crushing

WARNING



Never use the loader or its attachments to lift persons or as any kind of work platform even temporarily. Never climb on the loader or on the attachment. Seating capacity: one person only.

Moving loader can crush - Engage parking brake before working near the loader

WARNING



Follow safe stopping procedure to prevent all movements of the loader. Avoid leaving the loader parked on hill. If necessary to park on hill, use chocks or other additional means to prevent the loader from moving.

Pinching points - Avoid pinching between loader frame itself and between loader and walls - Keep all body parts within the safety frame

CAUTION

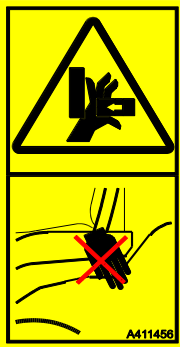

Movements of the articulated frame creates pinching hazards. Keep your head, hands, and feet inside the loader. Be especially careful while you drive near walls and trees. Keep your hands on steering wheel and joystick.

Avoid pinching hazard for legs - Do not turn the steering wheel while standing near the loader

CAUTION



Turning the articulated frame creates a pinching hazard to a person standing near the tyres of the loader. Never grab the steering wheel while entering or leaving the driver's seat to avoid turning of the frame. Stop the loader if other persons get close to the machine. Check that tyres that are larger than standard tyres leave enough space between the tyres for safe use.

Operation on uneven surfaces, gradients, and near excavations

Extra caution is needed when using the equipment on inclined terrains and slopes. Drive slowly especially on inclined, uneven, or slippery surfaces, and avoid sudden changes in speed or direction. Operate the controls of the loader with careful and smooth movements. Watch out for ditches, holes on the ground, and other obstacles, as hitting an obstacle may cause the loader to tip over.

Overturning of machine can lead to death or serious injury

WARNING



The stability and the load handling capacity of the loader are significantly reduced on inclined terrains and maximum lifting capacity can be achieved only on firm, level ground. On horizontally tilted terrain the load must be kept close to the ground and must never be lifted high.

- Handle heavy loads only on even surfaces.
- Drive very slowly on uneven terrains. Load, unload, and turn the machine on flat level ground only. Lifting a load or turning on uneven surfaces can lead to loss of stability.
- Do not drive on too steep a gradient - watch out for ditches, manholes and steep gradients, which may cause the loader to tip over.
- Never drive along an excavation. Note that the excavation or trench may suddenly cave in. Exercise extreme caution when driving near ditches or embankments, and avoid driving along a ditch or trench, as the machine could suddenly tip over if an edge caves in. Avoid driving along trenches and keep at least a distance equal to width of a trench.
- Do not park the machine on a surface with a gradient. Should this be necessary, engage the parking brake and preferably turn the machine sideways and put down the load. If needed, use chocks behind the wheels.

Personal safety and protective equipment

Wear safe clothing and personal protective equipment.

- Protect yourself against work hazards like noise, ejecting debris or dust for example.
- Follow regulations regarding protective equipment. Wear eye protection and hard hat or other protective equipment as needed.
- Read Operator's Manual of the attachment for more information about protective equipment needed in the work.



- The noise level at the driver's seat may exceed 85 dB(A). Wear hearing protection while working with the loader.



- Wear protective gloves.



- Wear safety boots whenever working with the loader.



- Wear safety glasses when handling hydraulic components.



- Always fasten seat belt while operating the machine.



- When working at construction sites, a safety helmet is recommended and may be mandatory in addition to the falling objects protective structure (FOPS) on the loader.



- Depending on work and working area, also a respirator mask may be required. Find out about other necessary safety equipment at your specific work site.



CAUTION

Silica dust warning. Prolonged exposure to crystalline silica can cause a lung disease called silicosis. Occupational health and safety officials recommend limiting exposure to dust that is present at most earth-moving and many other work sites. Avoid spreading of dust where possible, keep loader cabin clean from dust, use respiration mask when necessary.

Safety frame (ROPS) and safety canopy (FOPS)

The loader is equipped with a Rolling Over Protective Structure (ROPS) and a Falling Object Protective structure (FOPS). These safety structures are important parts of operator safety, and they must be fitted on the machine.

Safety frame (ROPS) protects the operator in case the machine tips over. Fasten seat belt while operating a machine with a ROPS. All cab versions are ROPS & FOPS tested and certified.

Crushing hazard - Always keep safety structures installed



WARNING

Never take off the safety structures, modify them, or attempt to repair. If damaged, contact service.



Always fasten the seat belt in order to stay inside the protected area of the safety frame.

Modifications

Any modification to this machine must be approved beforehand by an authorised Avant representative. If you modify the loader or attachment, it can become dangerous and cause serious injuries or even death. Unauthorised modifications can increase the risk of accidents and damage or shorten the service life of the machine. Modifications to electric systems can make the no longer compliant with regulations concerning electromagnetic emissions. Use only original spare parts to make sure that the product is kept in safe operating condition.

Working near powerlines

Digging may expose buried electric cables, and some attachments may make it possible to reach overhead powerlines with the loader, creating hazard of electric shock and electrocution.

Plan work ahead and take necessary safety precautions.

Stay away from electric cables - Electrocution hazard

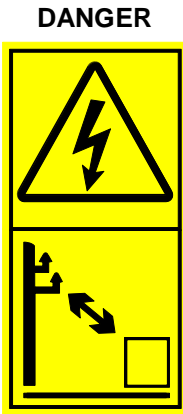

Electric shock hazard - Contact with or working too close to electric wires can result in lethal electric shock. Keep the loader and any attachment at a sufficient distance from all electric cables, see table below.

Table 1 - Safety distance from powerlines

Voltage level	Safety distance
0 - 1000 V	2 m
1 - 45 kV	3 m
110 kV	4 m
220 kV -	5 m
Unknown voltage	5 m

If electric cables are exposed during digging, or in case of inadvertent contact or proximity with live electric source:

- Do not leave the loader until the electricity has been disconnected by qualified technicians, usually local electric company.
- If absolutely necessary, jump out from the loader, keeping feet next to each other, until at a safe distance.
- Warn others not to approach the loader until safe to do so.

Fire prevention

Clean the loader to avoid build-up of flammable debris, such as dust, leaves, hay, straw, etc.

- There are many parts on the electric system that operate at high temperatures in normal use. To avoid fire, and to ensure that the cooling of electric systems is ensured, keep the electric parts clean. Overheating of electric parts can shorten their service life.
- **Static electricity can produce sparks when removing plastic covers.**
- Do not smoke while you work near the battery, or do any maintenance work of the hydraulic system.
- Add hydraulic oil only at a well ventilated place.
- Oil leaks can ignite on hot components. Repair any damaged or leaking components before using machine.

Know where fire extinguishing equipment is located near your working site. At some areas a fire extinguisher may be mandatory. Keep a multi-purpose, approved type fire extinguisher available near the place where you store the loader.

Electric system and handling of the battery pack



WARNING

The loader is fitted with a high-energy battery pack that can output hazardous, lethal levels of current and voltage. Misuse or using of damaged battery system creates a risk of battery explosion, fire, hazardous electric shock, and acid spill from battery. Follow the instructions regarding charge, use, and maintenance of the battery and the electric systems in this manual.

Battery systems on e5

The energy from the battery pack is used in two parallel systems:

- 48-volt supply from battery is converted by an inverter to a high-voltage and high-current electric power to drive the electric motors
- A 48 v to 12 v converter supplies electricity to the control systems of the loader, hydraulic valves, dashboard, electric socket etc.

Never modify the 48-volt system or connect any device directly to it. This system can output high current that can kill or cause electric shock and burns, if handled carelessly and safety systems are bypassed. See maintenance instructions on page 75.

DANGER

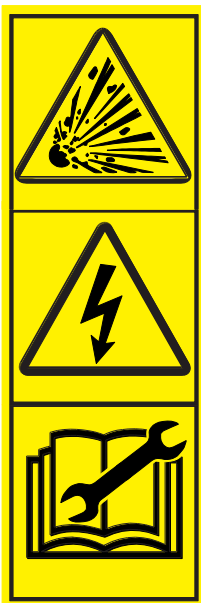

Short-circuit can cause the battery to explode or burn - Disconnect battery before maintenance.

Isolate the battery from the electric systems of the loader by separating its quick connector before working on the electric systems of the loader, see page 82. Check that all insulator sleeves and caps are in good condition and that battery terminals are not exposed. Never lay metal objects on the battery.

Handle battery with care

- Battery contains corrosive sulphuric acid which causes serious burns upon skin contact. Avoid contact with skin or clothes. If electrolyte gets on your skin or clothes, flush with a lot of water. In case of contact with eyes, flush with a lot of water for at least 15 minutes and see a doctor immediately.
- If a fuse is blown repeatedly, find out the cause. Always use fuses with correct rating.
- Disconnect the battery by separating the main connector. Never disconnect individual battery cells.

CAUTION



Risk of exposure to battery acid

- Handle battery with care and read maintenance instructions.

Using a damaged battery, extreme heat, improper charging procedure, or other type of wrong use can cause the battery cells to rupture and leak or spray acid electrolyte. Always follow use and maintenance instructions. Never use damaged battery.

CAUTION



Lead warning - Wear protective gloves.

Battery and its terminals contain lead, a harmful substance which should not be handled more than what is necessary. Wear protective gloves when handling battery. Wash hands with soap and water after handling the battery.



Risk of electric shock and contact with acid - Never disassemble the battery pack.

Battery pack does not include other serviceable parts than those described on page 75. Never remove individual battery cells from the battery pack. Keep all insulators in place.

First aid measures



Risk of serious burns - Avoid contact with battery acid.

Battery contains sulphuric acid as electrolyte. This acid is highly corrosive and can cause serious skin burns, in case of contact with skin. If acid gets to eyes, there is a serious risk of severe eye injury. Follow correct handling instructions of battery to avoid exposure to acid. Always use only battery that is in good condition.



In case you are exposed to battery electrolyte (sulphuric acid):

- After contact to skin:
Rinse immediately with plenty of water. Remove and wash wetted clothing.
- After contact with eyes:
Rinse immediately with plenty of running water for several minutes and seek medical advice immediately.
- If you inhale acid mist:
Inhale fresh air and seek medical advice:
- After swallowing:
Drink a lot of water immediately. Swallow activated carbon and seek medical advice immediately.

Follow correct charging procedure

Ensure ventilation and remove the rear cover before recharge

Recharge the loader only at a well-ventilated place. Never recharge in a small garage or shed, where there is no fan-operated ventilation to ventilate gases to outdoor air.

To allow the battery gas to ventilate properly, remove the rear top cover and leave open when recharging the battery. Leaving the rear cover removed will also allow the battery to cool better during recharge.

Use only the integrated charger of the loader to charge the battery

Use only the original, integrated charger to charge the battery. This ensures that the charge voltage and current are optimised in different phases of the charge cycle. Other charger types, especially those with higher output current, can overheat the battery. Overheating can cause the electrolyte to boil and battery can deteriorate or its useful life will be shortened as a result.

During charge, some of the water in the battery is broken into hydrogen and oxygen gases. This gas mixture is highly flammable and can become explosive, if enough gas is accumulated. The area where the loader is charged must be ventilated so that the amount of these released gases will not become explosive.

- Make sure that the ventilation is sufficient when charging the battery. Preferably charge the loader outdoors.
- Keep arcs, sparks, flames, lighted tobacco and other sources of heat away from battery.
- Charge the battery only with the built-in charger of the loader. If you connect any other charger to the battery, the battery can get too hot, too high current can cause electrolyte to spill from the battery, and the battery can be damaged.
- Check the battery for external damages, leakages, and deformations. Never charge the battery or operate the loader if you see that the battery is damaged.

WARNING

Battery produces explosive gas during recharge - Make sure to charge only on well ventilated area.

- Make sure that ventilation is sufficient when charging the battery.
- Never charge the loader in a small garage or shed where there is no ventilation.
- Keep arcs, sparks, flames, and lighted tobacco away from battery.
- Never charge damaged or frozen battery.
- See detailed instructions about charge process starting from page 63.

To ensure fire safety during recharge

Follow correct recharge instructions. Battery produces explosive gases during recharge and therefore ventilation must be ensured. Sparks, lighted tobacco products, and other sources of ignition must be kept away from loader during recharge.

- Plug the loader only to a grounded mains plug.
- It is recommended to use a mains outlet with a residual current switch device to protect from electric shock in case insulation of cables is damaged. Those devices must be tested periodically.
- Use extension cables only if necessary. Use as short cables as possible. Choose only high quality cables with large conductor cross-section. Poor quality cables can heat up and even burn.
- Avoid cable loops to prevent heating of the cable. Unwind any long cable that is coiled, otherwise the cable can overheat and burn. During charge, the electric power that runs through the cable is about 2300 watts.
- Make sure the fuses of the mains plug are adequate for the loader.
- Avoid creating static electricity while loader is charging. Do not wipe or otherwise clean the loader during charge.
- Make sure all charger and battery cables are insulated and correctly connected.

**WARNING****Risk of battery explosion - Never charge frozen battery.**

Discharged battery can freeze. A frozen battery can explode during charging. Never charge a frozen battery, allow the loader to warm at a warm place first, if loader has been left in freezing temperatures with low battery. Prevent freezing by keeping the battery charged especially when there are chances of freezing temperatures.

Description of the loader

Identification of the loader

Write down the identification information of your loader in the following fields, it facilitates ordering of spare parts etc.

1. Loader model _____

2. Loader serial no. _____

Serial number of the loader is printed on the type plate, which also indicates the loader model.

Dealer: _____

Contact information _____

Loader identification

Loader identification plate is located on the right side of the steering wheel.



Main parts of the loader

Following picture shows the main parts of the loader:



1. Front frame

On the front frame are mounted: driver's seat, operating controls, parking brake, hydraulic control valves, hydraulic oil tank, auxiliary hydraulics outlet, front wheels, hydraulic motors and the loader boom with attachment coupling plate.

2. Back frame

On the back frame are mounted: battery pack, electric motors, integrated charger and its socket, hydraulic pumps, rear wheels, hydraulic motors, and counterweights.

3. Articulation joint

Articulation joint connects the front and back frame. The loader is steered hydraulically by the steering cylinder which is mounted between the front and back frames. Hydraulic hoses and electric wires are conducted through the articulation joint.

4. Loader boom

Loader boom is mounted on the front frame and is controlled with control lever from the driver's seat. The attachment coupling plate is mounted at the end of the boom. The boom is telescopic, extending 600 mm hydraulically. The boom can be fitted with a hydraulic self-levelling system

5. Attachment coupling plate

Attachments are mounted on the attachment coupling plate. The locking pins on the plate can be operated manually (standard) or hydraulically (option).

6. Auxiliary hydraulics outlet

The hydraulic hoses of hydraulically operated attachments are mounted on this outlet. The outlet is equipped with the multi connector quick coupling system and is double acting: it has two pressure lines and one tank line, see page 61. If the loader is equipped with the optional Attachment control switch pack, its electric socket is integrated in the multi connector.

In addition, as an option, it is also possible to install a double-acting auxiliary hydraulics outlet in the front. The quick coupling of this extra outlet will be located under the multi connector.

7. ROPS safety frame

ROPS frame (Roll-over protective structure) complies with the standard ISO 3471:1994 with Amendment 1:1997 and Technical Corrigendum 1:2000 for a maximum machine configuration mass of 2720 kg.

8. FOPS canopy

FOPS canopy (Falling objects protective structure) mounts on the ROPS. It meets the ISO 3449:2005 (1365 J) criteria.

Signs and decals

Shown in the figure below and listed on the following page are the labels and markings, which must be visible on the equipment. Replace any warning label which has become unclear, or has detached completely. New labels are available via your retailer or contact information provided on the cover.

Before applying a new decal, clean the surface from dirt, dust, grease, or other material. Peel small portion of the decal backing paper and apply exposed adhesive to cleaned surface, aligning the decal properly. Peel rest of backing paper and press with hands to smooth out the decal.



The warning labels contain important safety information and they help to identify and remember the hazards related to the equipment.

Make sure that the following signs and decals are clean, undamaged and readable. If any of these decals is missing or is unreadable it should be replaced without delay. Ask for new decals from your local Avant dealer.



Table 2 - List of safety labels and markings on the machine





Label	Location	Product code
<p>1</p>  <p> <ul style="list-style-type: none"> Always perform a daily inspection of the machine before starting operation Operate the control levers and the steering wheel only when sitting in the driver's seat When coupling the attachment, make sure that the locking pins of the attachment coupling plate lock properly down in the holes of the attachment Do not transport the load with the boom lifted. Always carry bucket or attachment as low as possible, and with the telescopic boom completely retracted Drive slowly and do not turn sharply on uneven terrains. Watch out for ditches, manholes and steep gradients Keep hands, feet and clothing away from any moving part Do not transport persons with the machine Before leaving driver's seat: <ul style="list-style-type: none"> Lower the boom down to the ground Engage the parking brake Stop the engine Remove ignition key and turn battery disconnect switch to OFF position </p>	<p>Below steering wheel</p>	<p>A414690</p>
<p>2</p> 	<p>Boom, on both sides</p>	<p>A417273 (2 pcs)</p> <p>DANGER</p> <p>Lowering of loader boom can crush, causing death or serious injury.</p> <p>Keep out from the danger zone of the machine.</p>
<p>3</p> 	<p>Near electric motors</p>	<p>A417270</p> <p>WARNING</p> <p>Risk of burns - Extremely hot surfaces. Keep clear.</p> <p>Allow loader to cool completely before maintenance.</p>
<p>4</p> 	<p>At loader entry point</p>	<p>A411455</p> <p>WARNING</p> <p>Risk of crushing - Small gap between tyres of articulated loader. Do not grip the steering wheel from outside the machine or when getting into the driver's seat to prevent moving of the wheels.</p>
<p>5</p> 	<p>At loader entry point</p>	<p>A411456</p> <p>WARNING</p> <p>Risk of crushing - Keep hands and feet within the driver's area.</p>

Table 2 Continued - List of safety labels and markings on the machine

Label	Location	Product code	Message
	Next to steering wheel	A420354	CAUTION Using the parking brake while machine is moving may cause locking of wheels and sudden stop. Always engage the parking brake after stopping the machine first. The parking brake should be used to stop the machine only in emergency. Repeated use while driving will damage the brakes.

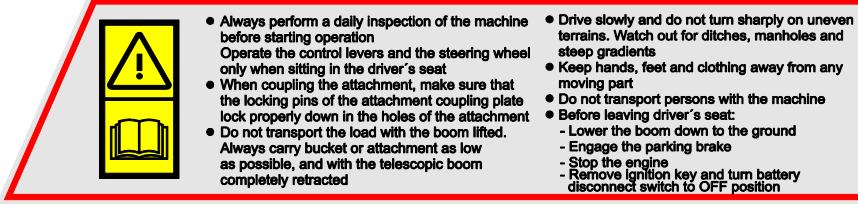
Table 3 - Information labels

Label	Location	Product code	Message
	ROPS frame	A420726	ROPS/FOPS Approval
	Right panel near driver's seat	A43600	Sound pressure level 88 dB(A) at driver's seat
	Right panel near driver's seat	A411047	Sound power level 101 dB(A) 2000/14/EC
	Front panel below driver's seat	A415780	Correct type of hydraulic oil

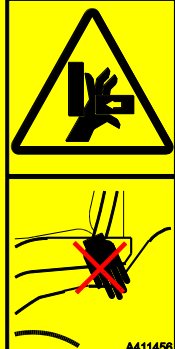
Technical specifications

Dimensions

General dimensions	
Length	2550 mm
Width	1130 mm (with standard tyres)
Height	1985 mm (with standard tyres)
Mass (empty)	1600 kg
Tyres	Standard: 23 x 10.50-12" TR / GR
Lifting height	2820 mm
Max reach	1100 mm (distance from standard front wheels to quick coupling plate)
Turning radius, inside/outside	995 mm / 2050 mm
Ground clearance	200 mm

Height and width

Tyre	Width	Height
23 x 8.50-12" TR	1080 mm	1980 mm
23 x 10.50-12" TR	1130 mm	1985 mm
26 x 12.00-12" TR	1290 mm	2013 mm
320/60-12" HD TR	1290 mm	2013 mm
27 x 8.50-15" TR	1030 mm	2026 mm
26.5 x 14.00-12" TR	1420 mm	2020 mm
23 x 8.50-12" GR	1080 mm	1980 mm
23 x 10.50-12" GR	1130 mm	1895 mm
26 x 12.00-12" GR	1290 mm	2013 mm

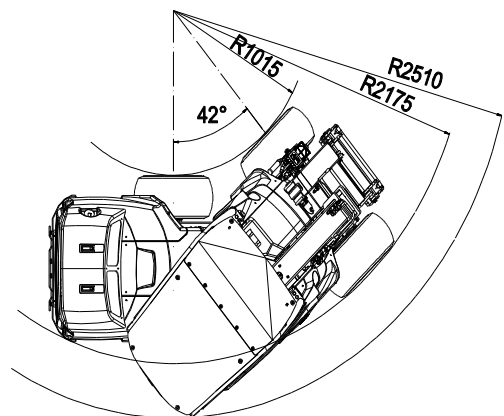
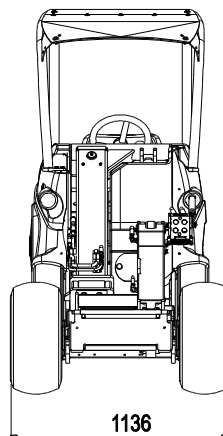
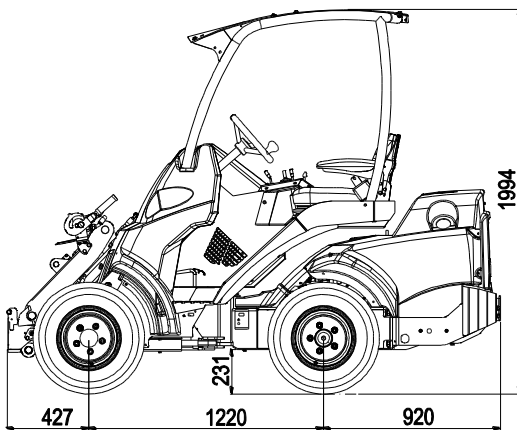

General specifications

	e5
Category	Earth-moving machinery / Loader / Compact loader EN ISO 6165
Product code	A21714
Drive system	Hydrostatic 4WD
Tipping load ISO 14397-1 (see also page 27)	970 kg
Rated operating capacity	480 kg
Pulling force	Static min 640 daN
Auxiliary hydraulics *See also page 24	Max 18,5 MPa (185 bar) Max flow Front: 30 l/min
Hydraulic pumps	2
Auxiliary hydraulics	Standard: Faster multiconnector system on front
Attachment coupling	Avant quick coupling attachment plate
Hydraulic oil capacity	<HydroilC_e5>
Hydraulic oil type	ISO VG 46, mineral oil only
Sound pressure level 2000/14/EC L _p , ISO 6396	88 dB(A) dB(A)
Sound power level 2000/14/EC L _p , ISO 6395	101 dB(A) dB(A)
Hand-arm vibration, total	< 2,5 m/s ²
Whole-body vibration, max.	< 0,5 m/s ²

Electric system and battery

	e5
Battery type	Lead acid battery pack
Battery product code	66390
Stored energy	11,5 kWh
Capacity	240 Ah
Voltage (nominal)	48 V
Electric motors	2
Battery cycle life	1500 cycles (estimate). See page 64
Control system and accessories	12 V / 22 A DC-DC converter
Charging system	Integrated charger
Mains current plug for charger	Schuko, grounded
Charger voltage and current	See page 66
Charging current	Controlled by charger, max 40 A ,48 v / 10 A, 230 v

Auxiliary hydraulics oil flow

The graph below shows auxiliary hydraulics output flow at different rpm levels of the electric motor. The rpm of electric motor of the auxiliary hydraulics pump is controlled with the hand throttle lever.

Some attachment may work optimally at certain flow level, use the graph to estimate correct rpm setting.

NOTICE

The hand throttle lever controls only the auxiliary hydraulic pumps. The position of the hand throttle lever does not affect the speed or pushing power of the drive system. Keep the rpm setting as low as possible to smoothly operate the attachment to conserve energy. Pull the throttle lever back when not operating an attachment.

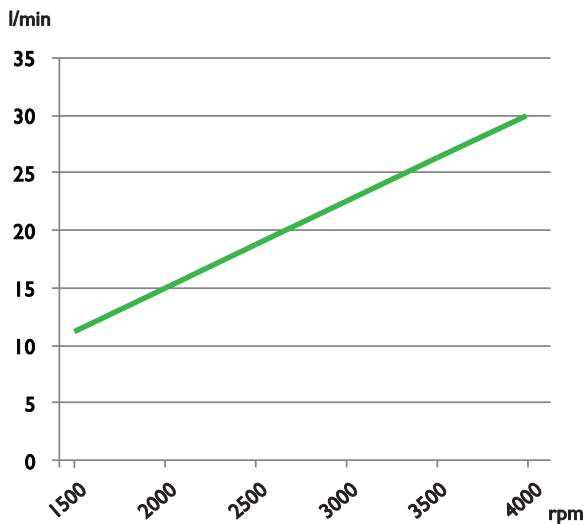

NOTICE

Maximum auxiliary hydraulics oil flow cannot be used with all attachments. Check correct rpm level for each attachment with the help of this graph and the Operator's Manual of each individual attachment. Attachment may get damaged, run too fast, or it may be difficult to control precisely when oil flow is too high.

Drive speed and pulling force

	Tyre	Drive speed	Pulling force
e5 TR	23 x 8.50-12" TR	9 km/h	100 %
	23 x 10.50-12" TR	9 km/h	100 %
	26 x 12.00-12" TR	9 km/h	85 %
	320/60-12" HD TR	10 km/h	80 %
	27 x 8.50-15" TR	10 km/h	80 %
	26.5 x 14.00-12" TR	11 km/h	75%
e5 GR	23 x 8.50-12" GR	9 km/h	95 %
	23 x 10.50-12" GR	9 km/h	100 %
	26 x 12.00-12" GR	9 km/h	85 %

* The maximum speed of the loader is the highest speed that can be achieved in optimal conditions. Load distribution, tyre pressures, ground surface, and many other conditions influence the maximum speed.

** The pulling force depends on the size of the tyres. In the table pulling force with each tyre model is listed as comparison with the standard tyres (100 %).

Tyres

The loader can be equipped with different type of tyres for different operating conditions. Grass pattern (GR) tyres will damage the ground surface less than tractor (TR) tyres, but provide less traction.

Tyre	Tread pattern	Code	Fill pressure	Fits with fenders		Fits with snow chains	
				Front	Rear	SD	HD
27 x 8.50-15"	TR	65414	4,2 bar	-	-	65723	-
23 x 8.50-12"	TR	65995	3,4 bar	x	x	64746	64455
23 x 8.50-12"	GR	65994	4,6 bar	x	x	64746	64455
23 x 10.50-12"	TR	65997	2,5 bar	x	x	-	64745
23 x 10.50-12"	GR	65996	3,0 bar	x	x	-	64745
26 x 12.00-12"	TR	65739	3,4 bar	x	x	-	64973
26 x 12.00-12"	GR	65212	3,4 bar	x	x	-	64973
320/60-12" HD	TR	65224	4,0 bar	x	x	-	65603
26.5 x 14.00-12"	TR	65787	1,8 bar	-	-	-	-

* When using the 26,5x14.00-12" tyres (code 65787), use of 40 mm wheel spacers is mandatory to fit these tyres. See more information below.

For the best stability and controllability, always use the largest tyres possible. Tyres that are narrower than the standard tyres are intended for special purposes only with width restriction on the machine.

Use only tyres and rims that meet the original specifications and dimensions to avoid potential issues with load capacity, tyre size, or bearing load on drive motors. Special tyres, such as studded wheels may also be available. Consult your dealer for further information.

Use widest tyres possible



Risk of tipping over - Make sure tyres are not damaged. Loss of tyre pressure can cause loader to tip over. Make sure there are no visible damages on tyres. Keep tyre pressure within recommendations.

Wheel spacers

The wheels can be fitted with spacers that increase the width of the loader for better stability. The spacers A417486 are 40 mm thick. They must be installed in order to fit the wide 26.5x14.00-12" tyres.



Wheel spacers improve the lateral stability of the loader. Do not remove the wheel spacers unless operating the loader on flat areas, where the total width of the loader must be reduced to as narrow as possible.

NOTICE

Use only spacers recommended by the manufacturer. Too thick spacers may damage the hydraulic motors. Contact your Avant dealer for more information.

Snow chains

Snow chains available at time of print of this manual are listed in tyre table above. When using snow chains, the fenders must be removed when using larger tyre models.

There are two types of snow chains. See the table on page 25 for a list of chains that are available for the tyre size of your loader.



SD



HD

Check that snow chains fit without hitting any part of the loader. Check also that the snow tyres will fit when the loader is turned to maximum articulation.

Ballasted tyres

Some tyres can be filled with special type of heavy foam that creates additional counterweight. The filled tyres are also useful in area where frequent tyre puncture with normal tyres would be expected.

When driving with a loader that has ballasted tyres, the acceleration and stopping distances may be increased.

Ballasted tyres do not have air pressure inside them and do not require air pressure checks.

CAUTION

Ballasted tyres are heavy - Handle ballasted tyres with care. Filling of tyres should be left to professional tyre service.

When the loader is equipped with ballasted tyres, the following symbol must be applied to a visible location on the loader frame near tyres. If you replace the tyres and install normal tyres, make sure to also remove this label.

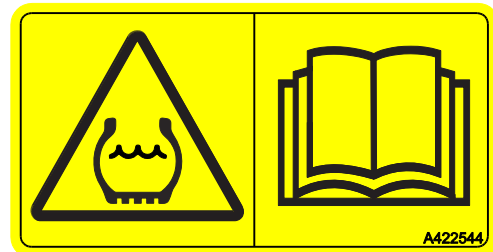

Tipping load

Tipping load is the load at which the rear tyres lose contact with the ground and the loader starts to tip forward. A tipping load chart is shown on the next page. The tipping load depends on many factors, and the chart shows the influence of the position of the loader boom.

The lifting capacity and the stability of the loader are at the best, when:

- the loader frame is kept straight
- the centre of gravity of the load is as close to the loader as possible
- counterweights are fitted to the loader
- swinging of the load is prevented and all controls are used in a calm and careful manner

There are many influencing factors that affect the stability of the loader in practise. Use the load chart and ROC table to estimate the load handling capacity of the loader. Observe the instructions and information given in this manual.

See also page 50 for more information about safe handling of heavy loads and page 51 for a list of typical factors that influence the stability of the loader.

The indicated tipping loads and the ROC table are valid, when:

- The ground is firm and level
- Loader is stationary or driven max 2 km/h, with smooth and slow control movements
- Driver 75 kg is seated on the driver's seat
- Load is distributed evenly on pallet forks, with the load centre of gravity at 400 mm from the vertical part of pallet fork arms. The weight of the fork attachment is taken into account in the indicated load values

WARNING

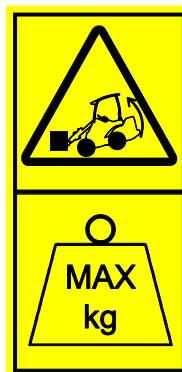

Risk of tipping over - Follow safety instructions. The lifting capacity of the loader is limited by the possibility of tipping around the front axle.

The operator must pay attention to safe operating conditions whenever handling loads.



WARNING

All counterweights affect stability - Also the driver. Always keep in mind: If the driver leaves the machine, tipping and max. loads are reduced respectively.

Tipping load - load chart

With the load diagram below, you can estimate the load handling capability of the loader.

The tipping load depends according to the distance between the centre of gravity of the load and the front axle of the loader.

The diagram represents the forward stability only. *It does not refer to maximum available lift force.*



Avoid overloading the loader - Know the load and lifting capacity of the loader. Heavy load can cause tipping over when moving the load. The diagram is valid only on firm and level ground, with the conditions listed above. When the boom is moved to another position, the load can exceed tipping load and loader can tip over.

Load chart e5

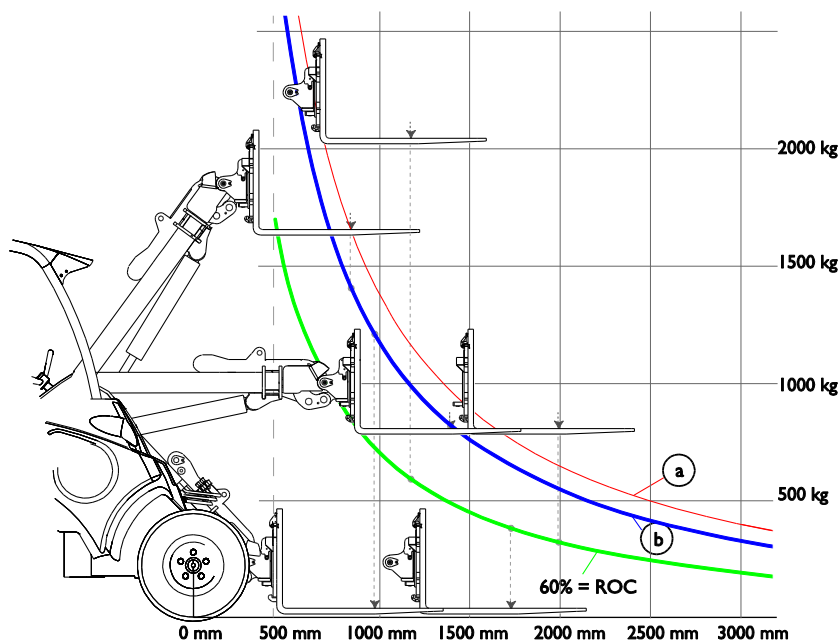

How to read the load chart

- a Tipping load with the loader frame in straight position.
- b Tipping load with the loader frame in maximum articulation.
- ROC (Rated operating capacity), defined as 60 % of tipping load for pallet forks.

Example: If the centre of gravity of the load is 970 mm in front of the front axle (400 mm from the pallet forks at ground level)

- Tipping load is about 1230 kg with a driver weighing 75 kg, and with the articulated frame turned to max articulation.
- When lifting to horizontal position, the tipping load is reduced to about 830 kg.
- This means that a pallet with a total weight of 1200 kg can be lifted just off the ground.

Rated operating capacity

To easily determine how much load the loader can handle safely, a table of the tipping load and a calculated Rated Operating Capacity (ROC) is shown in the adjacent label. The label is also visible from the driver's seat.

Rated operating capacity depends on type of use of the loader:

- In bucket and general application the rated operating capacity is 50% of tipping load
- In pallet fork application the rated operating capacity is 60% of tipping load

The information shown in the table is the worst case minimum load, with the conditions listed on page 27. Actual lifting capacity could be significantly higher, or it may be lower, depending on terrain conditions, available lifting force, and load distribution. Adding or removing counterweights will affect the indicated ROC.

Rated operating capacity label

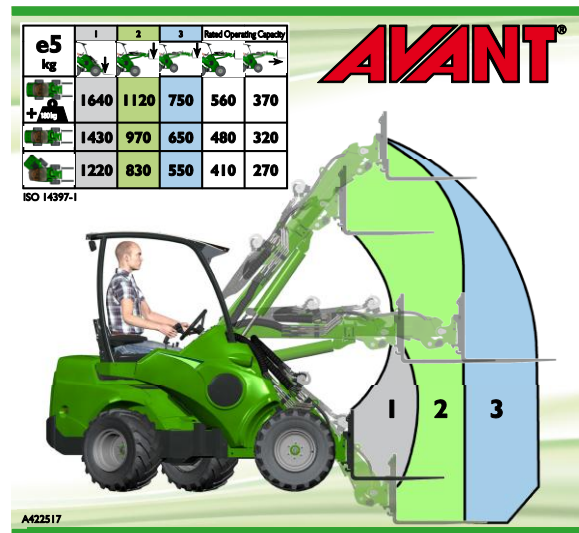

Different loader configurations, rows in the label:

1. Loader frame in straight position, additional 180 kg counterweights fitted
2. Loader frame in straight position, standard counterweight fitted
3. Loader frame in fully articulated position, standard counterweight fitted

Different positions of the loader boom, columns in the label:

1. Maximum tipping load, stability when lifting load just off the ground with pallet forks
2. Boom lifted to horizontal position
3. Boom lifted to horizontal position, telescopic boom fully extended (least stable position)
4. Rated operating capacity in pallet fork application, telescopic boom retracted
5. Rated operating capacity in pallet fork application, telescopic boom fully extended

Controls and options of the Loader

Following picture shows the location of operating controls. The location and function of controls may be slightly different in different models, see following pages.

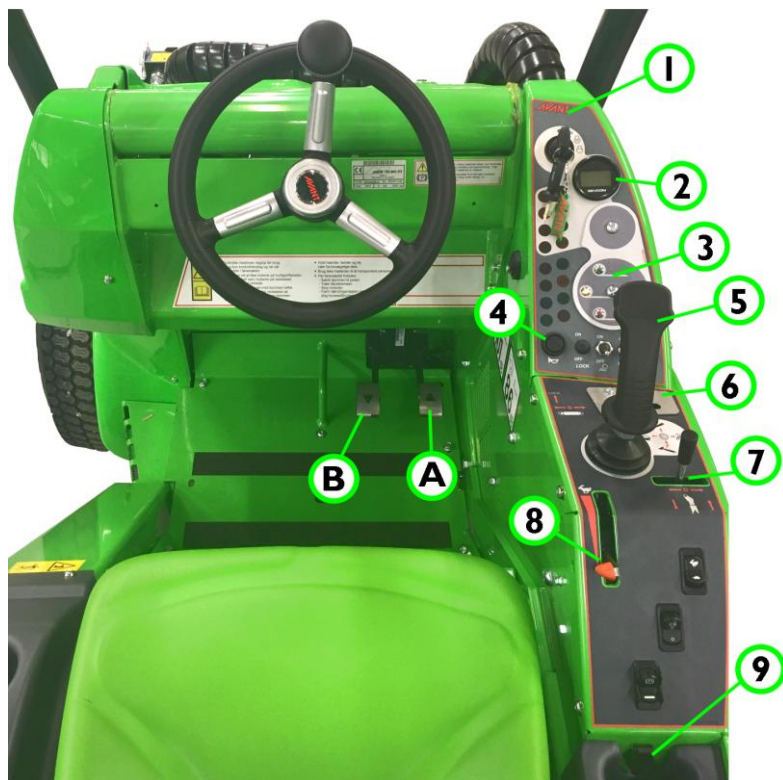

Reference	Page
1. Dashboard Ignition switch	31
2. Multi-function Display	35
3. Charger status lights	31
4. Signal horn switch Control switches (see below)	
5. Control lever of boom and bucket	32
6. Auxiliary hydraulics control lever	32
7. Boom telescope control	33
8. Hand throttle lever	34
9. 12 V outlet (max 15 A)	35

Controls in footwell

- A Drive pedal, right: drive forward (see below)
- B Drive pedal, left: drive backward (see below)

Switches on the panel						
<p>NOTE: Some of the switches presented here are for optional equipment and might not be installed on the loader.</p> <p>The position of the switch may be different than shown in here.</p>		<p>Auxiliary hydraulics outlet selection switch</p> <p>Optional equipment</p> <p>See page 41</p>		<p>Extra work lights on the ROPS frame, 2 front, 1 rear</p> <p>Optional equipment</p>		<p>Drive mode / speed range selection switch.</p> <p>See page 47</p>
		<p>Warning beacon</p> <p>Optional equipment</p> <p>See page see page 37</p>		<p>Operation mode selection switch</p> <p>See page 46</p>		<p>Hydraulic locking pins, attachment coupling</p> <p>Optional equipment</p> <p>See page 58</p>
		<p>Parking brake</p> <p>See page 35</p>		<p>Windscreen wiper and washer (CAB L option)</p> <p>see page 38</p>		<p>Emergency blinker</p> <p>Optional equipment</p>

Dashboard

Dashboard e5

On the dashboard there is the ignition key, and additional switches and indicator lamps.

The multi-function display shows information about battery charge level, hours of use, and diagnostics related trouble codes. The display is backlit whenever the ignition key is switched on. The hour metre runs whenever the electric motors are running.



Indicator lights

	Symbol	Colour	Remarks
1			<i>Not in use in this loader model</i>
2		Red	Hydraulic oil cooler fan fuse Hydraulic oil cooler malfunction. See page 85
3		Blue	High beam headlights on Road traffic light kit only
4		Green	Turn signal indicator Road traffic light kit only
5		Green	Seat heater on
6		Yellow	Boom floating on (optional equipment) Boom floating See page 39
7		Green	Work lights on Work light switch at lower part of dashboard
8			<i>Not in use in this loader model</i>

Charging indicator lights

	Symbol	Colour	Remarks
9		Green	Battery fully charged
10		Yellow	Charge in progress Full charge will take about 4 hours. Battery charge process See page 63.
11		Red	Battery not charging Charging system has detected a fault and has prevented charging to protect the battery from damage, see troubleshooting on page 87.

Switches on the dashboard

LOCK	<i>Switch not in use with this loader model</i>		Standard work lights		Boom floating		Seat heater
-------------	---	--	----------------------	--	---------------	--	-------------

Control of loader boom, auxiliary hydraulics and other functions

Most of the functions of the loader are controlled with the controls at the right side of the operator: Boom and bucket movements, auxiliary hydraulics (attachments), auxiliary hydraulics pump speed etc., depending on loader model. Following paragraphs show the different functions.

1. Control lever of boom and bucket

The loader boom and bucket are controlled with the multi-function lever sideways (tilt) and back & forward (boom up & down).

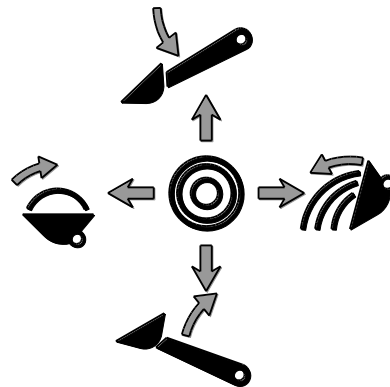

- Pull backward to lift the boom
- Push forward to lower the boom
- Push left to raise the tip of the bucket (filling)
- Push right to lower the tip of the bucket (emptying)

2. Control lever of auxiliary hydraulics (hydraulically operated attachments)

Hydraulically operated attachments are connected to the loader using the multi connector system, for more information see page 61.

- Operation directions depend on the attachment used.
 - When using an attachment for the first time, carefully move the lever to test and check the operating direction of the attachment.
- For continuous operation of rotating attachments, turn to direction 1 and turn to locking position.
- If operating the buttons of the electric joystick, this lever will not move. Either the lever or the buttons can be used to control the attachment as needed.

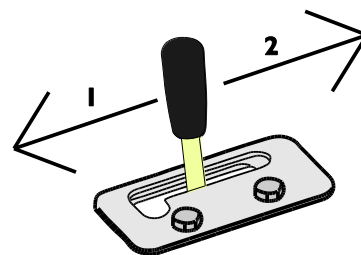

NOTICE

When you operate attachments that require continuous flow, such as attachments with hydraulic motors, it is important to have the control lever in fully engaged position. If the control valve is not fully open, restricting the flow of hydraulic oil, hydraulic system may overheat quickly.

If necessary, adjust the locking plate so that the lever is locked to fully open position.

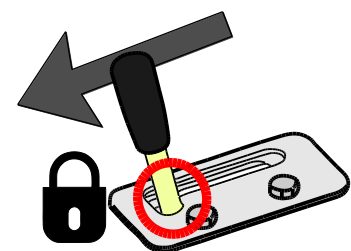

3. Telescopic boom control lever

The telescopic boom makes many tasks easier, also those that do not involve lifting. You can, for example, push material further with a bucket, reach into difficult areas, and improve visibility to the work area with some attachments.



The telescopic boom can be extended by 600 mm. It increases the maximum lifting height by 485 mm.

Turn the control lever of the telescopic boom to the right to extend the boom, and turn to the left to retract it.

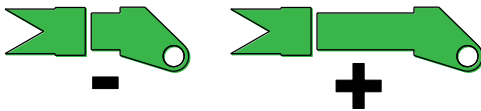

Risk of tipping over - Extended boom can cause the loader to tip over. Use telescopic boom with caution. The stability of the loader depends on the distance of the load from the front of the loader. When you extend the boom, you increase the effect of the weight and reduce safe handling capacity. See pages 27 and 50 for further instructions about tipping load and safe material handling.

4. Joystick - 6 function (optional extra)

If the loader is equipped with the optional 6 function joystick, the auxiliary hydraulics can be controlled with electric buttons on the joystick:



- Push and hold either button to operate hydraulic feature of the attachment. While holding a button, the manual control lever also moves to corresponding direction.
- The operation of the buttons depends on the attachment, see Operator's Manual of the attachment.
- Release buttons to stop.
- Make sure the manual control lever is not locked when operating electric joystick.



Avoid abrupt movements of an attachment - Use electric buttons with caution. When you use certain attachments with the electric joystick buttons, the attachments can move abruptly. This can cause falling of material from the attachment, loss of stability, or damage to attachment.

5. Hand throttle lever for pump RPM control

The electric motors run when the ignition key is switched to ON position, and when the operator is seated on driver's seat, or other operating mode is selected. See more information about the operator presence control on page 46.

The hand throttle lever controls the output and rotation speed of the auxiliary hydraulics pump. The drive system is controlled with drive pedals and the hand throttle lever will influence only the auxiliary hydraulics pump, not the drive system.

- Push the lever forward to increase rpm of hydraulic pumps and increase auxiliary hydraulics oil flow
- Pull backward to reduce rpm of hydraulic pumps and to decrease auxiliary hydraulics oil flow

The auxiliary hydraulics pump will also provide pressure for the release of the parking brake, and to flush the drive circuit. This is why the auxiliary hydraulics pump will operate whenever the loader is ready to be driven. However, to conserve battery energy, adjust the speed of the pump to a minimum setting whenever not actively using a hydraulic attachment.

As the hand throttle lever controls the output of hydraulic flow, this will also influence the speed of a hydraulically driven attachment. In general, the more throttle, the faster the attachment operates. Make sure not to exceed max. allowed oil flow of the attachment, see ***Auxiliary hydraulics oil flow*** on page 24.

Attachment control switch pack (optional extra)



If your loader is equipped with the optional attachment control switch pack, the electric functions of an attachment can be controlled with the extra buttons fitted on the joystick.

Check the operator's manual of the attachment to see how to control each attachment.

When the loader is equipped with the Attachment control switch pack, the Multi connector (see page 61) includes also an electric socket, so that the hydraulic hoses and the electric cable of an attachment with electric function(s) can be coupled simultaneously with the multi connector system.

Parking brake switch

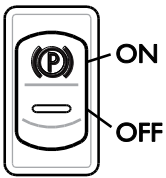

Switch on the parking brake whenever leaving the driver's seat.

The loader is equipped with a brake system that locks the rear wheels. The parking brake is activated when loader is switched off or when hydraulic pressure is otherwise lost due to a failure. Parking brake can be released only when the loader is running and the auxiliary hydraulics pump creates enough pressure for the brakes to release.



CAUTION

Using the parking brake while machine is moving may cause locking of wheels and sudden stop.

Always engage the parking brake after stopping the machine first. The parking brake should be used to stop the machine only in emergency. Repeated use while driving will damage the brakes.

Multi-function display

The multi-function display shows the following information when the loader is in normal operating mode:

- Battery charge level
- Operating hours (symbol with letter **p** visible)



During start-up the display will quickly cycle through the following:

- Total pump run time
- Total time of how long key has been in position ON
- Total traction pump run time

In case the control system of the loader has detected a fault in the control system of the loader, the display will show a diagnostics fault code. For more information about diagnostics codes, see page 86.

Electric 12 V outlet

When operating attachments with electric features, the electric harness of the attachment can be connected to the 12-volt outlet on the dashboard. The standard type outlet is powered when ignition is switched on. Maximum current: 10 A.

The total 12 v electricity output capacity of the loader is limited. This available power shared between lights, control system, and all additional accessories, such as seat heater etc. High-current accessories should not be connected to this electric socket. Keep in mind that all additional electric equipment reduce the battery run time. Switch off all unnecessary equipment.

There is an electric socket for the attachment on the multiconnector if the loader is equipped with the optional attachment control switch pack. In this case the electric plug of the attachment will be connected simultaneously with its hydraulic hoses. In case there is no electric plug on the multiconnector of the attachment, use the separate electric harness to connect to the regular 12 V outlet of the loader. You can also contact your Avant dealer to fit an electric plug to the attachment multiconnector.

Risk of fire and electric shock - Never connect any device directly to the battery.



WARNING

The battery is able to produce high electric current that can burn or injure severely, and even cause death. Short-circuit can cause the battery to burn or explode. Never connect any device directly to the 48 volt systems of the loader.

Seat - Seat belt and seat adjustments



The seating capacity of the loader is one person only. Never carry passengers on part of the loader or with any attachment.

Always use seat belt while driving. Clean the seat belt regularly with a sponge, warm water, and soap. Use compressed air to clean the buckle.

Replace the seat belt if any damage is seen, or if the seat belt is exposed to high load or chemicals.

Seat adjustments

Make sure that the seat is properly adjusted for easy reach to the operating controls and to keep vibrations transmitted by the seat at minimum. Long term exposure to vibrations may cause health effects. Also, as far as possible, keep the operating terrain in good condition to minimise vibrations.

Suspension seat

The suspension seat has the following adjustments:

1. Seat position

The distance of the seat from the steering wheel can be adjusted with the lever which is located under the front edge of the seat

2. Arm rest angle adjustment

The angle of the arm rest can be adjusted by turning the roller under the arm rest

Adjust the arm rest to position which allows to use controls of the loader comfortably while keeping arm on the arm rest.

3. Suspension adjustment

By turning the knob counter-clockwise suspension gets harder, by turning it clockwise the suspension gets softer

4. Angle of the back rest

The angle of the back rest can be adjusted by pulling the lever



Seat heater

The suspension seat is equipped with an electric seat heater. Seat heater switch and its indicator lamp are situated on the dashboard.

Lights

Work lights

The loader is equipped with standard work lights at the front of the loader, which are controlled with a switch near the ignition switch.

If the loader is equipped with the optional road traffic light kit, the standard work lights are replaced with road headlights.

Extra work light kit (option)

The loader can be equipped with extra work lights, making it easier to work in low light. The lights are operated with the switch on the control panel
Switches on the panel.

Warning beacon (option)

The beacon can be removed quickly by loosening its retaining screw and then by pulling the beacon out. Place the protective seal on the beacon stand to prevent water entering and damaging the connectors. Handle beacon with care. The beacon is sealed and its inner components cannot be replaced or repaired by user.

NOTICE

Beacon includes high-voltage components. Do not use or repair damaged beacon, replace with new one.

CAB L (optional extra)

The e5 can be equipped, as an option, with cab L. Shown in this chapter are the controls and features that differ from the standard ROPS model.



In case the normal opening on the left side of the loader is blocked, the windscreen can be used as an emergency exit.

If necessary, the windscreen can be broken with the emergency hammer located in the cab.

Windscreen washer and wiper

On machines with cab L, the windscreen washer is operated with a switch on the switch panel. The switch has the following functions:

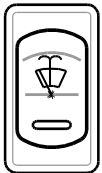

2. Spray washer fluid
1. Continuous operation
0. Off

The windscreen washer fluid tank is located on under the access step of the loader. The filler opening is on the access step.

Cab Safety

Make sure visibility from the cab is adequate. Keep all window panels clean and clear of snow, ice, etc.

Familiarise yourself with the special drive features and space needs of this articulated loader, equipped with cab, on a flat, even and open place.

Remember that, when turning, the cab extends beyond the turning radius of the wheels. This should be taken into consideration especially when driving in confined spaces, in order that the rear of the cab will not get damaged.

Options

This section shows how to use correctly and safely the options that are installed to your loader.

Most of the options can be installed to your loader by your Avant service point. Contact your dealer or service point for more information and availability of the options.

Boom self-levelling



Self-levelling is a system that keeps the attachment tilted in same position when lifting or lowering the boom.

Self levelling is an automatic hydraulic system. There is a levelling cylinder on the left side of the boom which follows the movements of the loader boom and keeps the attachment level.

NOTE: Self levelling is disabled when the boom floating is switched on.

NOTICE

When the attachment tilt is turned to either extreme position, the boom lift cylinder will have to work against the pressure of the self levelling cylinder.

To prevent extreme stresses to the loader boom, operate the bucket tilt control to move out from extreme tilt before lifting or lowering the boom.

Boom floating

The boom floating is a system that allows an attachment to follow the surface of the ground. The floating system releases the lift cylinder and allows it to float upwards from the position where it is when boom floating is switched on. When boom floating is switched on, it is not possible to push down with the boom.

To switch on the boom floating:

1. Lower the attachment on the ground to the position where it will be used
2. Switch on the floating with a switch on the dashboard, see page 31.

Boom floating indicator light on the dashboard is lit when the system is switched on.

During boom floating, some air may become sucked into the lift cylinder. To avoid unexpected or inaccurate movements of the boom, the air in cylinders must be removed by moving the boom to extreme lift positions after switching off the floating system.

After use of boom floating



WARNING

Risk of unexpected movements - Move the loader boom after you have switched off the boom floating to remove air from cylinders. During the use of boom floating air can get trapped in the hydraulic system. This can cause inaccurate movements of loader boom and the boom can even move down.

Therefore the boom and attachment coupling plate should always be moved to extreme end positions after switching off boom floating.

NOTICE

Self levelling is disabled when the boom floating is switched on. Boom can't be pushed down with hydraulic force, when floating is on. Use boom floating only when necessary.

Counterweights

Additional counterweights can be installed to increase the stability of loader when handling heavy loads or attachments.

1. 29 kg individual weights A35957

Max 3 pcs.

If you install a trailer coupling, only one extra weight can be used.



2. 80 kg side weight kit A36401

One 40 kg weight to both sides of the loader.



3. 180 kg side weight kit A49063

One 90 kg weight installed to both sides of the loader.



The side weight kits will not increase the total width of the loader (depending on tyre model).

e5 uses its battery pack as a standard counterweight. The 170 kg rear counterweight, available for some loader models, cannot be installed to e5 because of different rear frame construction.

Make sure that the weight on the trailer is distributed correctly so that the trailer cannot cause an upward lifting force on the trailer coupling. It is recommended that you keep an attachment fitted at the front of the loader to add weight to the front of the loader.



Risk of loss of control of loader - Too much counterweight can make the front of the loader too light. If you install too much counterweights to the loader, the front wheels of the loader will be easily lifted from the ground. This will make steering of the loader difficult. If counterweights are fitted to handle a certain attachment, remove counterweights if driving without an attachment.



Risk of sudden loss of stability - Always install any counterweight firmly. Counterweight can fall from the loader on uneven ground or after hitting a wall or other structure. Tighten all fastening screws. After installing the 180 kg side weight kit, remove their lifting slings from the weights to prevent their use as tie down points.

Trailer coupling

The loader can be equipped with a trailer coupling for towing of light trailers. There are two types available:

1. 50 mm ball hitch A417323



2. 50 mm ball hitch with towing pin A417337



Trailer coupling can be mounted either directly on the rear bumper or on the extra back weight.

- Max. allowed vertical load 1,5 kN
- Maximum towing load is 10 kN.

Make sure that the weight on the trailer is distributed correctly so that the trailer cannot cause an upward lifting force on the trailer coupling. It is recommended that you keep an attachment fitted at the front of the loader to add weight to the front of the loader.



Overload on the trailer coupling may cause loss of control. Tow only light garden trailers. Make sure that the weight on the trailer is distributed correctly so that the trailer cannot cause an upward lifting force on the trailer coupling.

Rear carrier

To use certain attachments, or carry extra loads at the rear of the loader, a rear carrier is available.



Risk of loss of control of the loader - Never add too heavy load on the rear. Too heavy loads or attachment at the rear of the loader, especially if combined with extra counterweights, can make the front of the loader too light. Front wheels can lose contact from the ground. Ensure that loader is loaded evenly. Remove counterweights if necessary.



Risk of shearing of hands or fingers and impact - Unlocked or improperly locked rear carrier can swing. Make sure both of the locking pins of the rear carrier are locked. Unlocked carrier can swing in uncontrolled way, creating hazards of impact, crushing, and pinching between its linkage. If attachment gets damaged because of unlocked carrier, it can cause oil spray and fire. Unlock the carrier in controlled way and keep hands clear from linkage.

Extra auxiliary hydraulics outlet

In addition to the standard auxiliary hydraulics outlet, the loader can be equipped with a double acting extra outlet. The couplers are conventional type quick couplers.

Extra quick couplers located under the multi-connector, at the front of the loader.



For instructions about use and how to connect or disconnect the extra hydraulic couplings, see page 41.

You can operate either the hydraulic function connected to the standard multiconnector, or the function that is connected to the extra outlet. Simultaneous use is not possible.

Reverse buzzer (option)

A reverse buzzer gives an audible signal whenever reversing with the loader. This alarms others of an approaching machine and thus improves safety.

Operating instructions



Always remember – safety first. Test all the functions of the loader at an open and safe place. Make sure that there are no persons in the operating area of the machine and the danger zone of the attachment.



DANGER

Careless operation can injure you or bystanders - Keep the loader under control at all times. Operating a powerful loader and its attachments requires the full attention of the operator. Do not perform distractive actions while operating, such as using mobile devices.



WARNING

Pay attention to other machines and persons that are moving in the area. Make sure that there are no persons in the danger zone of the loader and the attachment. The danger zone of the loader covers the reach area of the loader boom, the turning area on the side and in the front and rear of the loader. Always put down the load when leaving the machine – the loader is not designed to stay with the loader boom and load lifted. Learn how to operate the loader in a safe place.

Starting the loader

Before starting the loader do the daily checks. See page 73.

Adjust the seat and mirrors (if fitted) so that you have a good working position and unrestricted field of vision from the driver's seat. Check that all controls function correctly. See to it that the operating area is safe.

Make sure you have all operating manuals available. Read and follow all operating and safety instructions.



If auxiliary hydraulics is switched on during starting and there is a hydraulically operated attachment on the machine, the attachment can move suddenly and cause a dangerous situation.

- Make sure that the auxiliary hydraulics control lever is in neutral position during starting.
- Do not actuate the auxiliary hydraulics control buttons on the joystick when starting (if fitted).

NOTICE

The e5 loader will not start in either of the following conditions

- Electric motors will not start if driver is not seated on driver's seat.

When the ignition switch is switched to position ON, motors will start as soon as driver is seated on the seat.

- Drive functions are disabled if either drive pedal is depressed during start. Drive function is enabled after release of pedals.

Ignition key

The ignition key controls both the operation of the loader and the main battery disconnect switch.

Turning the ignition switch beyond the position ON is possible, but unnecessary.



Prevent unintended movements of the loader. Keep hands and feet away from other controls of the loader while starting. A fault code will appear if you press a pedal during start of the loader.



Misuse can be dangerous - Prevent unauthorised use, remove key. Powerful loader and its attachments can be dangerous in the hands of an inexperienced temporary operator. Take the key with you to prevent unauthorised use of the equipment.

NOTICE

To operate the auxiliary hydraulics or drive pedals, you must be seated on the driver's seat. Safety system prevents use of hydraulic systems, unless seated on the seat. If you use an attachment that is controlled from other position than the driver's seat, see page 46.

Battery disconnect switch

The loader is equipped with an electrically controlled battery disconnect switch (main switch). The automatic battery disconnect cuts the current between battery and the rest of the electric system whenever ignition key is switched to position OFF. To switch on the electric systems of the loader, turn the ignition key to position ON and wait for a few seconds.

To start the loader:

1. Perform daily checks (see **Maintenance & Service** on page 70)
2. Sit on the driver's seat, adjust seat, and fasten seat belt
3. Move the hand throttle lever to idle position
4. Make sure that auxiliary hydraulics is switched off (lever in neutral position), see page 32. *Do not press on the drive pedals.*
5. Turn the ignition key to position ON
 - Automatic battery disconnect switch will be switched on when ignition key is in this position

It is possible to turn the ignition key further, beyond the position ON. However, this has no effect on e5 loader model.

NOTICE

Make sure there are no remaining warning messages on the multi-function display after start. If the motors do not start after you have turned the ignition switch to position ON, see **troubleshoot** on page 87.

Stopping the loader (Safe stopping procedure)

1. Lower the boom completely down
2. Stop any attachment (move auxiliary hydraulics control lever to neutral position, see page 32), set hand throttle to rear position. Place attachment firmly on the ground
3. Engage parking brake
4. Stop the motors by turning the ignition key to the OFF position (to the left)
5. Release auxiliary hydraulics pressure (see page 62).
6. Prevent unauthorised use of the loader. Take the ignition key with you.

Stop if you notice any of the following:

NOTICE

Stop the loader to a safe state as soon as possible if you observe any of the following symptoms. Find out the cause before restarting.

- Battery charge level is below 10 %. Drive to a charging location and avoid heavy load
- Electric motor rpm increases and/or decreases suddenly by itself, even if you don't move the throttle lever, or press the pedals
- You notice sudden increase in vibration or noise levels

Tips to increase battery life

- Store the battery in recommended temperatures
- Operate the auxiliary hydraulics only at the speed that is necessary for the attachment or work. Too high flow will waste energy.
- Always switch off the auxiliary hydraulics when not actively using the attachments.

Drive control

Principle of operation

The Avant e5 loader is equipped with a hydrostatic drive system that is powered by an electric motor. The drive pedals are used to control the motor and the drive pump.

- Use the pedals to control driving direction and travel speed
- Speed and pulling force are controlled with the pedals. The more you press a pedal, the faster the loader will travel, or the higher the pulling force will be.
- Choose the most suitable drive mode with the drive/operating mode selection switch, see page 47

The position of the Hand throttle lever controls only the RPM of the auxiliary hydraulics system. Position of this lever will not affect drive speed or pulling force. The drive system works independently from the other hydraulic circuits that are controlled with the hand throttle lever.

When you do not actively use an attachment, keep the hand throttle lever set to a low rpm setting to conserve energy.



WARNING

Risk of collision or tip over - Use low speed when you practise the use of the loader. Familiarise yourself with the driving of the machine on low speed and on a flat, even and open place. Make sure that there are no persons in the operating area of the machine to avoid injuries that could result from unintended movements. When you have learned how to drive with slow speed operating mode, increase speed gradually and learn how to drive and steer the loader with higher drive speeds.



WARNING

Risk of tipping over - Avoid high speed turns. The loader can tip over, if you turn the steering wheel sharply while driving. Slow down before making sharp turns. Always control and steer the loader with smooth movements.

Operator presence control

The loader is equipped with a safety system that restricts the use of controls of the loader, if there is no driver on the driver's seat. There are two operating modes that are controlled with a switch on the panel:

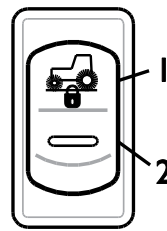

1. When control mode switch is switched to this position, auxiliary hydraulics can be operated while not seated on the seat. Drive pedals are disabled.

This makes it possible to operate attachments that are controlled with their own control systems. Those attachments may be intended to be operated from other position than from the driver's seat. See the intended use and operating position from the operator's manuals of those attachments.

2. In this mode, the drive pedals boom movements and auxiliary hydraulics can be used only while seated on the driver's seat

Drive pedals

- Driving forward: press gently on the right drive pedal until the machine starts to move slowly.
- To drive backward: press gently on the left drive pedal.
- When you wish to stop gently release the pedal by lifting of your foot, and the machine will slow and stop.

If you need stop more quickly, press the drive pedal of the opposite drive direction. Release both pedals as soon as the loader has stopped, otherwise the loader will immediately start to move to the direction of the drive pedal that is pressed.

Driving/operating modes

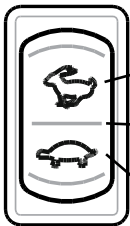

Operating mode selector changes the response of the drive pedals. The system can be optimised for power, maximum battery life, or greatest accuracy of control.

The maximum pulling force is the same regardless of the position of the switch.

1. Power mode

Use this mode when you need high speed or high auxiliary hydraulics output.

Battery run time may be short as result.

2. ECO mode

Use this mode for maximum battery run time.

Management of electric systems and hydraulic flow are optimised to avoid waste of energy.

Maximum speed and acceleration are limited.

3. Slow / inching mode

This mode provides modified response to drive pedal. This helps you to operate the loader in tight spaces, where great accuracy is needed, or when learning to operate the loader.

When you want to have a high pulling force:

- Drive pedals adjust both speed and torque. Pushing pedal further down will increase pulling force and speed. Press pedal only as much as needed
- The position of the driving mode switch does not affect pulling force
- The position of the hand throttle lever does not affect pulling force or drive speed
- If battery is low, and a high speed is requested with a drive pedal, the loader may not be able to produce maximum pulling force. Push pedal lighter in this case

OptiDrive™

The e5 loaders are equipped with efficient Avant OptiDrive™ hydraulic drive system as standard.

The system is designed for optimal hydraulic oil flow, which helps to conserve energy by minimising losses. This is achieved with the use of integrated high efficiency Avant valve blocks and new hose fittings.

OPTIDRIVE™

Drive release and anti slip

Drive release valve

The hydraulic drive circuit has a built-in drive release system, which allows the wheels on the left and right side of the machine to roll at different speeds to leave less tyre marks on soft surfaces. The system automatically limits the flow of hydraulic oil between the hydraulic motors on each side, functioning in similar way as a limited parallel differential lock, increasing pushing force of the loader. The system is always engaged.

Anti-slip valve (optional extra)

If the loader is equipped with optional anti-slip valve, the valve positively diverts oil flow between the right and left side hydraulic motors and improves traction on slippery and uneven surfaces. Some oil will pass between the left and right side of the loader, and also through hydraulic motors themselves. This means that even though all wheels do not slip and spin equally, all provide maximum pushing force.

Allow the loader to warm up properly

Hydraulic oil temperature has an effect on the hydrostatic drive system of the loader. When ambient temperature is below 5° C, make sure the general response to drive pedals is normal. If the drive feels sluggish, allow the hydraulic system to warm up by letting the auxiliary hydraulics pump to run at idle. Drive carefully until the loader has reached its normal operating temperature.



Risk of decreased braking power - Make sure hydraulic oil is not overheated. When hydraulic oil gets hot, driving characteristics of the drive system change. When the oil is hot and the hydraulic oil cooler has switched on, stopping distance of the machine can be longer than when the machine is cold. If the loader is used constantly in high ambient temperatures, hydraulic oil type and viscosity must be suitable for these conditions. Contact Avant service.



In case braking power of hydrostatic drive system has decreased, engage the parking brake. The rear wheels may lock immediately. Parking brake acts as an emergency brake, and will also engage in case of loss of oil pressure. Parking brake is intended to keep the loader stationary and not for repeated braking. Engage while loader moves only when necessary.

Battery system in cold environment

The battery pack is less capable to supply energy in cold environment. This sets a limit to the minimum operating temperature where the loader can be practically used. Operating in cold conditions will decrease battery performance and cold, stiff hydraulic oil will waste more energy.

The electrolyte temperature inside the battery cells should be at least +10°C before charging. Otherwise the battery will not recharge to completely full state.

To reach maximum battery capacity in freezing conditions, keep the loader stored in warm shelter. Battery will then remain relatively warm during use and will be able to output as much energy as possible.

Steering of the machine

The machine is steered with the steering wheel. The steering wheel is hydraulically powered. A practical way of controlling the loader is to steer with your left hand on the knob of the steering wheel. This way your right hand is free to operate other functions.

In case power is lost, you can still steer the loader with the steering wheel. There is an integrated back-up steering system, but steering will require more force.

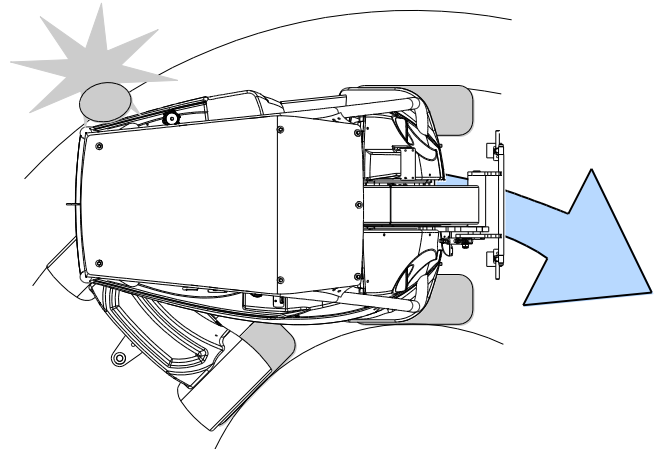

WARNING

Risk of tipping over - Keep loads close to ground while driving.

When driving, always keep the loader boom as low and close to the loader as possible. Risk of tipping over increases considerably when there is a heavy load on the loader (a heavy attachment or a big load in the bucket) and the boom is up when driving.



WARNING

Risk of tipping over - Never use a high drive speed when turning.

In particular: when the loader boom is up the stability of the machine is much weaker when turning. Keep loads close to ground while driving.



WARNING

Risk of collision and crushing - Stay and keep hands and feet inside the safety frame.

Always remember that when turning the driver's seat extends beyond the turning radius of the wheels.

Material handling

Make sure to use correct type of attachment for each handled material. Use correct size and type of bucket for general loose material handling, and pallet forks for handling pallet loads. Read the manual of the attachment, e.g. manual of the bucket, for further information for safe and correct use. Observe the lift capacity rating of the loader when planning material handling operations.

The loader is not intended for lifting operations; never put slings, chains, or ropes on the loader boom.

Handling of heavy loads



Carrying heavy loads can shift the centre of gravity of the loader and lead to tipping over of the loader. Always transport the load as low and close to the machine as possible to keep the centre of gravity low and for the best stability.

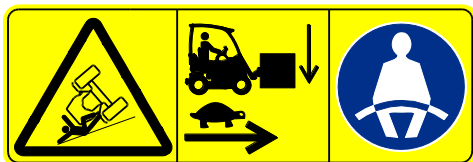

WARNING: Risk of rolling over - Keep loads close to ground, drive slow when carrying load.

Always use seat belt.



WARNING: Risk of tipping over (front direction) - Keep load close to ground, drive slowly.

Read operator's manual carefully.

Whenever you handle heavy loads or heavy attachments:

- Handle heavy loads only on firm, level ground, while you drive slowly with the machine.
 - Uneven or inclined terrain significantly reduces the safe working load, (see also page 27).
 - Use the maximum loads indicated in the diagram in this manual as a guideline.
 - All rated operating capacities are based on the criteria of the machine is level on a firm supporting ground. When the machine is operated in conditions that deviate from these criteria (e.g. on soft or uneven ground, on a slope or when subject to slide loads), you must take these conditions into account.
 - Remember that the actual load carrying capacity varies greatly according to operating conditions and control manner.
- Keep the articulated frame of the loader in straight position when you lift heavy loads. If you turn the loader during load handling, the stability of the loader will decrease and it may overturn the machine.
- The use of extra rear weights or ballasted tyres is recommended. See page 40 for different options.
- Make sure to follow the recommended tyre pressures.
- Pay attention that a heavy load or long distance between the loader and the centre of gravity of the load will affect the balance and handling of the loader.
- When estimating the lifting capacity of the loader, remember to take the weight of the attachment into account.



Loader can tip over when you leave the driver's seat. Always put the load down on the ground before leaving the driver's seat. Follow safe stopping procedure on page 45.

How to estimate actual lifting capacity

The actual tipping load and stability of the loader depends on many factors that you must consider when you handle heavy loads or attachments. Listed in the table below are many factors that influence the stability of the loader.

Always keep in mind the conditions listed in the following table.

Influencing factor	How you should take it into account
Position of the loader boom and telescope	Keep load as close to the ground as possible while you drive. Lift only when ready to unload the bucket or attachment <ul style="list-style-type: none"> ■ See load chart and ROC table to estimate the lift capacity of the loader on level ground. Reduce the indicated maximum load by always taking the local operating conditions into account
The total load on the loader boom	Estimate the combined weight of an empty attachment and load <ul style="list-style-type: none"> ■ Load chart is based on weight of pallet forks (90 kg) ■ If the attachment you use is heavier, subtract its weight from the listed tipping load accordingly ■ See the operator's manual of each attachment for attachment weight and possible information about permitted loads.
The distance of the load from the front tyres	The further away the load is from the loader, the less stable the loader is <ul style="list-style-type: none"> ■ Keep the load as close to the ground and the loader as possible ■ Never drive while load is lifted more than just off the ground
Straight or articulated position of the loader frame	If you turn the articulated frame, the loader will tip over more easily <ul style="list-style-type: none"> ■ Keep the loader in straight position when lifting heavy loads
Levelness of the ground	All listed values are applicable only on level, even ground <ul style="list-style-type: none"> ■ Drive slowly on uneven ground ■ Keep load close to ground and as close to the loader as possible
Installed counterweights	If counterweights are installed, the loader stability is better <ul style="list-style-type: none"> ■ Keep standard counterweights fitted ■ Consider the use of additional counterweights or ballasted tyres for additional stability
Driver presence	Driver acts as additional counterweight <ul style="list-style-type: none"> ■ Load chart is calculated with a 75 kg driver present on driver's seat ■ If you leave the driver's seat, loader can tip forward.
Movements of the loader and the load	Lifting of the maximum load is possible only when loader is not moving <ul style="list-style-type: none"> ■ Operate the controls of the loader slowly and in a smooth manner. Dynamic loads can cause loader to tip over ■ Secure load on the attachment. If load moves or swings, the loader can tip over ■ Use correct type of attachment for each type of load ■ Never lift swinging loads

In case the machine tips over

Avoid tipping over of the loader with careful operation and the instructions given throughout this manual. However, it is important to know what to do in case the machine tips over.



WARNING

Stay within the space protected by the ROPS safety frame. Always keep seat belt on to stay on driver's seat and to avoid getting crushed between ground and a loader that tips over.

NOTICE

In case the loader tips over

Switch off the loader immediately. Running electric motors and pumps of an overturned loader will get damaged quickly and will spill hydraulic oil.

As soon as possible, lift the loader back on its wheels to prevent spilling of hydraulic oil and battery electrolyte. The loader can in many cases be lifted back on its wheels by having a few persons to lift from the ROPS frame.

Transport instructions and tie down points

Before transporting or lifting mount the articulation frame lock, see page 72. Lower the boom down and disconnect battery.

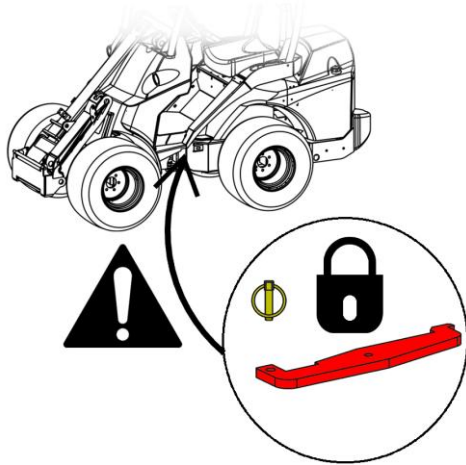

Always lock the frame lock before transporting or lifting the loader. Also remember to remove the frame lock and test the steering of the loader after transport.

- It may be necessary to tie down attachments separately.
- Make sure all panels are locked in place. Remove ignition key and any loose material that could come off while transport.

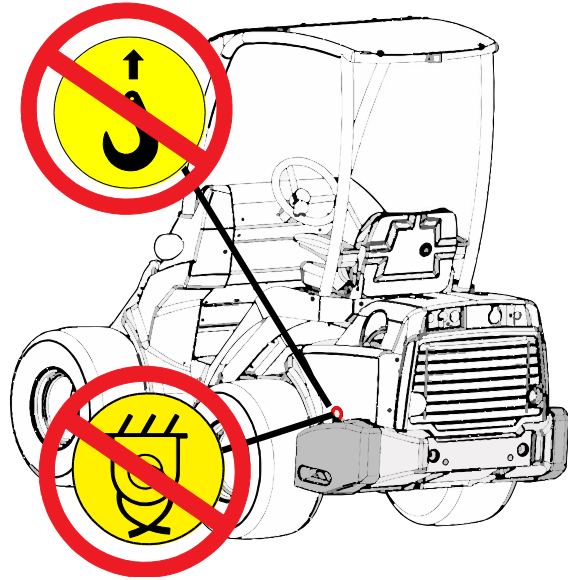

Tie down points

The loader must be tied down securely if transporting on a trailer. All four tie down points must be used. If an attachment is fitted, also it must be tied down.

As standard, there are 4 tie down points:

- Two on the front frame, close to the boom
- Two on the rear frame, near rear counterweight

To prepare the loader for transport, do the following:

- Always secure the load. Make sure all equipment is secured also before just a short transport.
- Always use straps or chains that are in good condition and rated for use as load securing device. Check all hooks and locks.
- Consider weight distribution on a trailer. Sometimes it might be appropriate to load the loader on trailer rear end first.
- Always make sure the trailer is balanced when loaded in sideways and front/rear directions. Trailer must never cause upward force on the trailer coupling of the towing vehicle.
- Lock the articulated frame lock.
- Lower boom completely down.



Risk of moving or falling of the loader - Never lift or tie down loader from side counterweights. Eyelets on extra side counterweights are for installing or removing the side counterweight only. Never attempt to lift the loader from the counterweights or use them as tie-down points.

Tie down options

Optional equipment for frequent trailer transport

If transporting the loader frequently on a trailer, optional tie down brackets are available for easier securing of load.

Tie down bracket A418623 installed at the rear bumper or counterweight



Tie down bracket A418623 installed at the side of rear frame



For side installation, two brackets are needed.

Tie down bracket on wheel hub A421206



Lifting

The loader can be lifted by mounting appropriate lifting slings on the ROPS frame. Lifting kit A418706 includes all necessary parts to lift the loader, contact your dealer.

Before lifting, heavy attachment and possible extra weights must be removed. Mount the frame lock on the machine.

Make sure that the lifting slings cannot move and that the machine doesn't swing during lifting. Loop the lifting straps around all four ROPS posts and make sure they are not tied or get damaged by e.g. sharp corners. Follow the instructions given in the operator's manual of the lifting slings. To lift a loader that is equipped with the Cab L, the front, side, and rear window panels must be removed first.



WARNING

Lower the boom and mount the articulation frame lock, see page 72. Remove any heavy attachment and extra counterweights before lifting. Never lift a loader with persons riding the machine.

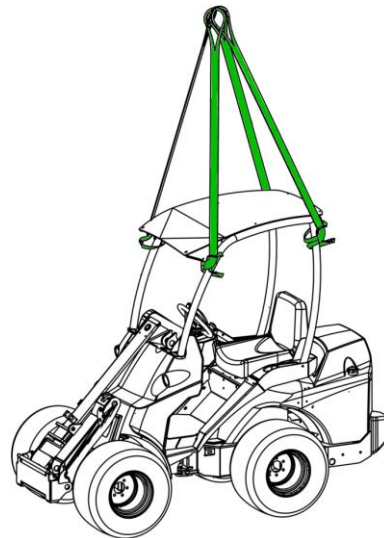

Towing (retrieval of the machine)

The hydrostatic drive system of the loader makes it impossible to tow the loader in other cases than moving the loader for a short distance. It is not possible to release the hydraulic parking brake or the drive circuit.

If necessary, the loader can be towed with a rigid tow bar. The wheels of the loader will not spin. Tow only at low speed and short distances.

Storage

If outdoors storage is necessary, protect the machine with the designated weather cover (part no. 65436).



NOTICE

Do not use the full, closed transport and weather cover over long periods of time as it promotes corrosion due to moisture that will condense inside it. The light weather cover can be used.

Storage of electric loader

NOTICE

Charge the battery to full charge before leaving the loader unused. Also, add water to battery, as instructed on page. Discharged battery can get damaged during storage.

The battery must be fully charged and water added before putting the loader to storage. The best place to store the battery pack is in a dry, frost-free place. The battery does not need to be removed or disconnected from the loader for storage. However, during long storage periods, disconnect the battery quick coupler from its counterpart on loader.

A monthly recharge is recommended to keep the battery in optimal condition.

Working with attachments

Requirements for attachments

Any attachment mounted on the loader must meet applicable safety and technical standards and requirements. An attachment that is not specifically designed for the loader may cause unsafe operation; make sure that Avant e5 is specifically listed in the operator's manual of the attachment. Some attachments may require the use of special protective guards or personal safety equipment.



- Read Operators Manual of the attachment before you begin to use any attachment.
- Make sure that the attachment is compatible with the loader. Contact your Avant dealer if necessary.
- Make sure that the attachment is connected properly on the attachment coupling plate, and that it is being used in accordance with the instructions in the Operators Manual. Follow instructions regarding personal protective equipment and safety distances.
- Put the attachment down on the ground and switch off the loader before leaving driver's seat. Familiarise yourself with the operation and stopping of the attachment at a safe place. Follow service instructions.

NOTICE

Check max. allowed hydraulic oil flow for the attachment. Adjust the speed of the hydraulic pump so that the output flow is suitable for the work and the attachment. See page 24.

Manuals of attachments



Attachments can create significant risks that are not covered by this Operator's manual of the loader.

Make sure you have all attachments manual available. Wrong use of an attachment can cause serious injuries or death.

Each attachment is accompanied by its own respective Operator's Manual. The manual will show important information related to safety, and how to attach, use, and maintain each attachment correctly.

Coupling the attachments

Attaching the attachment to the loader is quick and easy, but it must be done carefully. If the attachment is not locked to the loader, it may detach from the loader and cause a hazardous situation. The loader must not be driven and the boom must never be lifted when the attachment has not been locked. To prevent hazardous situations, always follow the coupling procedure shown below. Also remember the safety instructions shown in this manual.

The attachment is mounted to the loader boom by using the quick attach plate on the loader boom and the counterpart on the attachment. As standard, the attachment is coupled with two manually operated locking pins of the coupling plate. As an option, hydraulic coupling pins are available, which are controlled with an electric switch. The following steps show the coupling procedure regardless of the type of coupling types.



DANGER

Make sure that an unlocked attachment will not move or fall over. Do not stay in the area between the attachment and the loader. Mount the attachment only on level surface.

Never move or lift an attachment that has not been locked.



Always read also the additional instructions for coupling and using of the attachment in the Operator's Manual of the attachment.

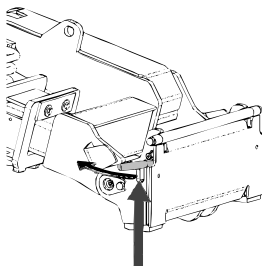

Step 1:

- Lift the quick attach plate locking pins up and turn them backwards into the slot so that they are locked in the upper position.

If your loader is equipped with a hydraulic attachment locking system, see how to operate the hydraulic locking on the following page.

- Ensure that the hydraulic hoses (and the electric harness, if applicable) are not in the way during installation.

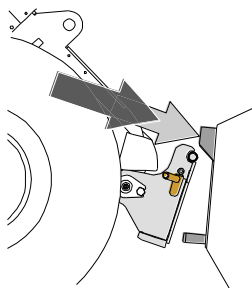

Step 2:

- Turn the quick attach plate hydraulically to an obliquely forward position.
- Drive the loader onto the attachment. If your loader is equipped with a telescopic boom, you can utilise this.
- Align the upper pins of the loader's quick coupling plate so that they are under the corresponding brackets of the attachment.

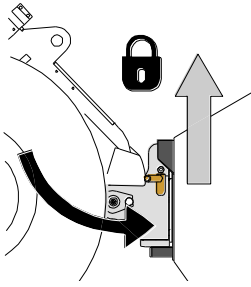

Step 3:

- Lift the boom slightly – pull the boom control lever backward to raise the attachment off the ground.
- Turn the boom control lever left to turn the bottom section of the quick attach plate onto the attachment.
- Lock the locking pins manually or lock the hydraulic locking.
- **Always check the locking of both locking pins.**



Risk of falling objects - Prevent dropping of attachment

- An attachment that has not been completely locked to the loader may fall on the boom or towards the operator, or fall under the loader during driving, causing loss of control of the loader. Never move or lift an attachment that has not been locked.
- Before moving or lifting the attachment, make sure that the locking pins are in the lower position and come through the fasteners on the attachment on both sides.

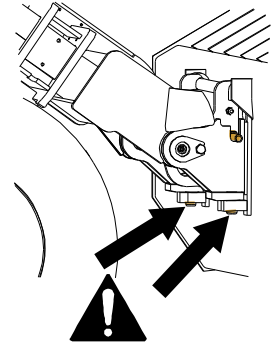

Hydraulic attachment coupling

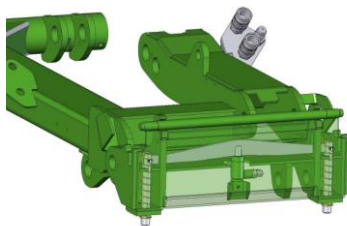

The optional hydraulic attachment coupling plate enables coupling and disconnecting of the attachment from driver's seat.

There is a hydraulic cylinder on the attachment coupling plate which moves the locking pins up and down. The electro-hydraulic system works when the loader ignition switch is in position ON.

Control switch is located at the control panel on the right (see page).



Risk of falling of attachment - Familiarize yourself with the controls of the loader.

Avoid dropping of the attachment. Operate the hydraulic coupling only when the attachment is close to the ground.

Always make sure that the locking pins lock properly down in the holes of the attachments also when using the hydraulic locking. Both pins must be locked.

Coupling adapters

Avant offers coupling adapters to help the use of some specific attachments. See the operator's manual of each attachment if an adapter can be used.

Both adapter types are locked to the quick coupling plate of the loader. The adapters have similar quick coupling system to lock the attachment onto the adapter and loader.

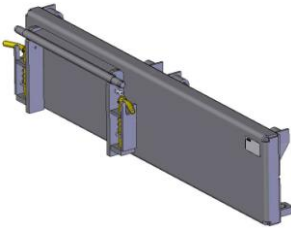

Side shift adapter A34893, A37097, or A37166

Side shift adapter is a rigid adapter plate which moves the attachment 40 cm or 60 cm to the right or to the left side depending on the model. It is intended for better side reach with attachment that are used on the ground, such as flail mowers on the side of a road.

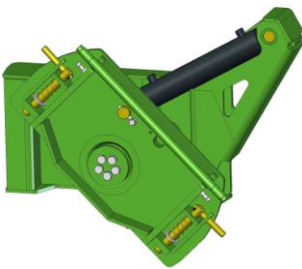

Tilt adapter A34148 or A36505

With a tilt adapter the attachment can be tilted sideways, which makes it possible to:

- Make different forms to the ground with a bucket or leveller
- Keep pallet fork level when you are driving on surfaces with gradient
- Load pallets that are on uneven ground
- Level ground on uneven surfaces

The tilt adapter is intended mainly for non-hydraulically operated attachments. With the optional second auxiliary hydraulics outlet in the front, it is possible to use hydraulically driven attachments, such as 4 in 1 bucket, pallet fork with hydraulic side shift, grabbing tool, and artificial turf attachment at the same time.

NOTICE

All coupling adapters are intended only for specific attachments that can be safely and efficiently used with an adapter. The adapters are not intended for general use. Any adapter should be removed from the loader when no longer using an attachment requiring it.

NOTICE

Avoid the use of bracket adapters that are intended for mounting of 200 series 1 attachments on other loaders. The 200 series 1 attachments are not designed to be used with other loader models than the 200 series.



CAUTION

Adapter plates reduce lifting capacity - Do not use adapters with heavy loads or attachments. The adapter plates move the centre of gravity of the attachment further away from the loader. This increases the risk of tipping over and can limit the use of heavy attachments.



CAUTION

Wrong type of attachment, poor attachment locking, or wrong technical characteristics of coupling brackets can cause hazards that are not taken into account by design of the loader or the individual attachment. Never use other than original Avant attachments and brackets. Use of other than original Avant equipment makes it necessary to carry out detailed engineering to ensure safety, performance, and reliability of the equipment. Consult your Avant dealer if unsure about the compatibility of equipment with your Avant loader.

Coupling the hydraulic hoses of the attachment

Hydraulic hoses of the attachment are equipped with the multi connector system, which connects all hoses at the same time.



WARNING

Never connect or disconnect quick couplings or other hydraulic components while the control lever of the auxiliary hydraulics control lever is locked on or if the system is pressurized. Connecting or disconnecting the hydraulic couplings while the system is pressurized may lead to unintended movements of the attachment, or ejection of high-pressure fluid, which can cause serious injuries or burns. Follow safe stopping procedure before disconnecting hydraulics.

Connecting the multi connector system:

1. Align the pins of the attachment connector with corresponding holes of the loader connector. The multi connector will not connect if the attachment connector is upside down.
2. Connect and lock the multi connector by turning the lever towards the loader.

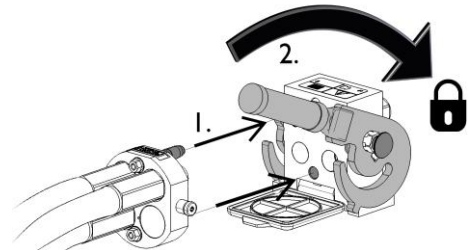

The lever should move easily all the way to its locking position. If the lever does not slide smoothly, check the alignment and position of the connector and clean the connectors. Also shut down the loader and release the residual hydraulic pressure.

To disconnect the multi connector system:

Before disconnecting put the attachment down on a solid and even surface.

1. Switch off the auxiliary hydraulics of the loader.
2. While pushing unlock button, turn the lever to disconnect the connector.
3. After ending operation put the multi connector on its holder on the attachment.

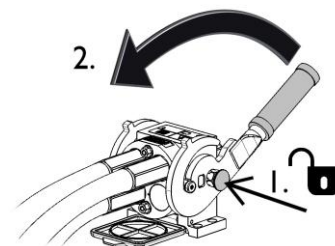

NOTICE

Keep all fittings as clean as possible; use the protective caps on both the attachment and the loader. Dirt, ice, etc. may make using the fittings significantly more difficult. Never leave the hoses hanging on the ground; place the couplings onto the holder on the attachment.

NOTICE

When fitting an attachment, make sure that the hydraulic hoses are not overstretched and are not in a position where they can be trapped during the operation of the machine and attachment.

Using the auxiliary hydraulics

Auxiliary hydraulics (hydraulically operated attachments) are controlled with the lever on the control panel, or with the buttons on the 6-function joystick (see page 32).

The locking position of the lever facilitates operation of the attachments that require constant oil flow (rotary broom, backhoe etc.). Make sure to release the lever when not operating an attachment to prevent unnecessary waste of energy.



DANGER

Risk of serious injuries from moving parts of the attachment - Keep all persons clear from the danger area of the attachment and loader boom. Going near an attachment that is in operation can cause a serious risk of injury. Switch off auxiliary hydraulics before leaving driver's seat. Operate the controls only when sitting in the driver's seat.

The 2-way auxiliary hydraulics control lever (see page 32) directs hydraulic as follows:

1. Moving towards the locking position will direct hydraulic flow to port 2. This is normally the normal or positive movement of the attachment.
2. Moving the lever away from the locking position will direct flow in reverse direction, pressure in port 1.
3. The third port is a free return line to tank, this is required by some attachments.
4. The 4th port is for the integrated electric socket of the optional Attachment control switch pack.

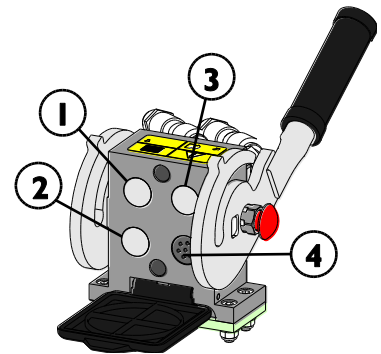

On Avant eSeries loaders, the auxiliary hydraulics can be used when:

- Driver is seated on the driver's seat
- or
- External use mode is selected with the Operation mode switch, see page 46.



WARNING

Overspeed of the attachment can cause injuries or dangerous movements of the attachment. The attachment can break down in a dangerous way, throw objects, or produce excessive noise and vibrations if operated at too high speed. Never exceed maximum allowed hydraulic flow of the attachment. Check correct operating flow from the operator's manuals of the attachment.

Releasing the residual pressure of hydraulic system

Make sure that there isn't pressure in the hydraulic system that could cause danger during service operations.

To release the pressure in hydraulic system:

1. Lower the boom down completely and place attachment firmly on the ground
2. Switch off the loader
3. Move all control levers, including the control lever of the telescopic boom and auxiliary hydraulics, to extreme end positions a couple of times

Remember that the boom or attachment can move when releasing the pressure. Move the levers until all movements have stopped.

Extra auxiliary hydraulics coupling

The extra hydraulics coupling is a double-acting hydraulic with two fittings. Pair of standard type hydraulic quick couplings are located at the front of the loader, just below the multiconnector.

- Before you connect or disconnect standard couplings, relieve hydraulic pressure as described on page
 - To connect and disconnect the standard couplings, move the collar at the end of the female fitting
- 
- Note that the protective caps on the loader and the attachment can be fastened to each other during operation to reduce the accumulation of dirt.
 - When disconnecting the standard quick couplings a small amount of oil may drip from the couplings. Wear protective gloves and have some cloth at hand to keep the equipment clean.

To use the extra hydraulics coupling:

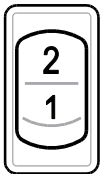

1. Activate the extra auxiliary hydraulics outlet:
Switch the selection switch of the hydraulic outlet to position **2**. The switch is located on the control panel on the right side from the driver's seat
2. Use the normal auxiliary hydraulics control lever to control the extra outlet, or use the buttons of the 6-function joystick
3. When you want to use the multiconnector outlet again, switch the control switch back to position 1

- The quick couplings can be coupled in a way that reverses the function of the control lever. Test the operation of the attachment after each time it is coupled to the loader.
- Keep the couplings clean and use their protective covers.

You can operate either the hydraulic function connected to the standard multiconnector, or the function that is connected to the extra outlet. Simultaneous use is not possible.

Battery and Charging

Follow the instructions in this chapter to ensure the full capacity and service life of the battery.

Correct charge cycle, safe area for recharge, water replenishment, and correct operating and charge temperatures must be taken into account when operating or recharging the loader.

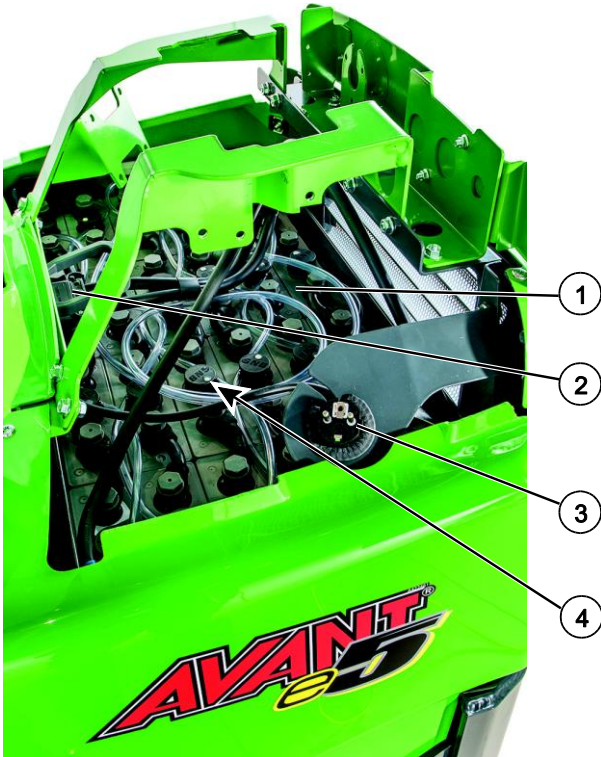

Remove the rear cover to access battery.

Under the cover you can see the following main parts of the battery pack:

1. Battery pack: 24 2-volt battery cells that are connected in series.
Connected water refill system with single quick connector
2. Battery main connector
3. Mains plug for recharge, integrated charger
4. Water level indicator on top of each individual cell

NOTICE

Leave the rear cover open during recharge to allow good ventilation of the battery.

Recharge - General principles

For the best performance of the battery, obey the following principles:

- Charge the battery immediately after using the loader

When you keep the battery fully charged, you ensure that the battery pack will retain its capacity as long as possible. Never store the loader with an empty battery.

- Always charge the battery in a well-ventilated area.

It is recommended that you remove the panel covering the battery compartment for the duration of the charging.

Follow safety instructions. Keep all sources of ignition away from battery that is being charged.

- Do a full charge frequently (charge until the green charge indicator light is lit)
- Never discharge the battery fully. This so called deep discharge will damage the battery.

NOTICE

Avoid deep discharge of the battery. Complete discharge can damage the battery.

Never operate the loader until there is no power left to drive the loader.

Charge the battery when the battery level indicator shows that no more than 10% of charge is left. Battery will wear out quickly in repeated deep discharge cycle use. Recharge fully discharged battery with complete charge cycle as soon as possible.

It is recommended to charge the battery, when its charge is dropped to about 20% to 30% level.

If you feel that machine starts to lose power even the battery indicator shows plenty of charge left, charge the battery immediately.

Battery life

The actual work times will vary greatly, depending on several factors. The following have high influence on battery duration:

- work cycle, accelerations and frequent stopping
- level of carried or lifted loads
- use of rotating attachments
- ambient temperatures
- Condition of battery and correct use and charge

Light to moderate use

Heavy use

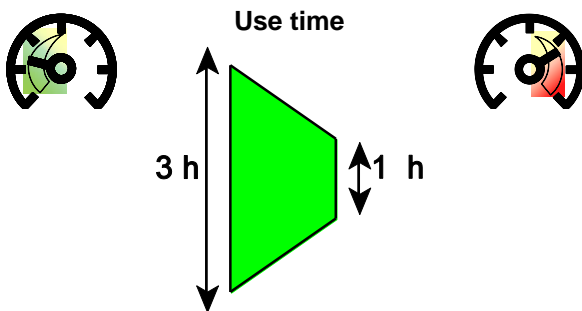

Using attachments that have a hydraulic motor and require constant, high flow and power of hydraulic oil, will use the energy of the battery quickly. Attachments that are used only short periods of time are best suited for the e5 loader.

A new battery pack will reach its maximum capacity only after a few recharge cycles. Battery pack will slowly degrade towards the end of its useful life.

Extreme conditions can shorten the battery life. Discharged battery can get frozen, which could permanently destroy the battery.

To keep the battery in good condition

To preserve the current draw capacity of the battery, observe the following rules regarding charge level.

- Always charge the loader immediately after use.
 - After heavy load or high ambient temperature, allow the loader and its battery to cool before recharge.
- It is recommended to charge the battery as soon as the charge level is dropped to 20-30%
- Always charge the battery immediately when the charge level is dropped to 10%. Discharge below this level should be avoided, as deep discharge will wear down the battery.
 - Never discharge the battery fully to a point where there is no energy left to drive the loader. Battery might get damaged and will no longer charge to full capacity.
- After each charge, check the battery water level and if water must be added. Operating with too low water level will damage the battery quickly.

Charging the battery

Preparation for charging

In preparation for charging, do the following:

- Choose a well ventilated place, where you can leave the loader safely for charging. Do not recharge in direct sunlight or rain.

When charging, proper provisions must be made for venting of the charging gases

- Open the rear cover of the loader to allow good ventilation

Leave all vent plugs, tubes, and covers of the battery itself installed

- If the battery is extremely hot, allow to cool before recharge
- Also read the safety information regarding the battery and electric systems on page 14

Charging site

Charge the loader in shade. In direct sunlight the battery may overheat during recharge.

Choose a well ventilated place, where you can leave the loader safely for recharge. When charging, proper provision must be made for venting of the charging gases. Never recharge in a closed building without good ventilation.

Charge after loader is allowed to cool

During recharge the temperature of the electrolyte rises by about 10°C, so begin to charge the loader only if the electrolyte temperature is below 45°C.

The loader is equipped with a cooling fan that is intended to cool the battery and electric components inside the loader. The fan is activated automatically when the temperature of the inverter, electric motors, or the battery has risen above a determined level.

WARNING



Battery produces explosive gas during recharge - Make sure to charge only on well ventilated area.

- Make sure that ventilation is sufficient when charging the battery.
- Never charge the loader in a small garage or shed where there is no ventilation.
- Keep arcs, sparks, flames, and lighted tobacco away from battery.
- Never charge damaged or frozen battery.
- See detailed instructions about charge process starting from page 63.

Charger

You can recharge the battery at any point regardless of the remaining energy left. Whenever possible, recharge immediately after use.

An integrated charger is standard equipment for all e5 loaders. Battery is fully charged and all cycles completed when the green charge indicator light is lit. The output current and voltage are controlled by the internal charger and the charge process is automated.

It is recommended to use only the integrated charger of the loader to charge the battery. The charge r output voltage and current are automatically adjusted during different phases of charge process. If you use an external charger, the charge voltage and current may be wrong for each phase of the charge, causing overheat or boiling of the battery, or damage to battery cells.

Charge times



4-5 h (80 %)
5-8 h (100 %)

Charge times shown here are typical times in normal operating temperatures and with a battery that is in good condition.

If the battery has been completely discharged, allow the charger to remain plugged for longer period of time to complete also the equalising charge phase.

Charge process

The status and phase of charge process is shown with the signal lamps on the dashboard, see page 31.

In case the red charge status lamp lights, the battery is not charging due to several possible reasons.

In addition to the charge signal lamps on the dashboard, there are identical signal lamps on charger itself. In case of trouble with charging, and signal lamps on dashboard do not turn on, see the lamps on the charger. To see these lamps, remove the cover below the seat frame.

Equalising charge

During the end of normal charge cycle, the slight differences of individual cells are balanced. The final phase of the charge cycle, called equalising charge, is completed when the green charge indicator light is lit.

For optimal performance of the battery, it is recommended to leave the charger mains plug connected until the battery is completely full. This full charge process must be made at least every 3 to 5 discharge cycles. The equalising charge is a slower charge process, but important for the performance of the battery.

NOTICE

Frequent equalising charges are vital for the life of the battery and to maintain its capacity. Full charge is especially necessary after a deep discharge or repeated incomplete recharges. Equalising charges are carried out following normal charging cycle, until the green indicator light on the dashboard is lit.

Charger plug type

The standard plug type to connect the loader to electric outlet is grounded CEE 7/7, commonly known in Europe as "Schuko" type. If you use the loader in areas where different kind of plug is needed, your local Avant dealer will give you any needed additional information. Regardless of the type of the plug, other instructions in this chapter apply to all electric Avant loaders.

The charger must be connected to electric outlet with correct voltage and current output: Charge only from a grounded electric socket, which is also protected with a fully functional residual current protection switch.

Voltage	Frequency	Required current (fuse)
220-240 V	50-60 Hz	10 A (minimum) 16 A (recommended)

If using plug adapters, use only high quality versions that are rated for outdoor use and that have also the grounding wire connected.

Keep extension cables as short as possible. Use good quality cables that have adequate cable cross-section for the required current.



**Risk of cable overheating and fire -
Avoid using extension cables.**

Long or thin extension cables can heat significantly during charging and melt, causing risk of electric shock or fire. Avoid using extension cables. If necessary, use only as short as possible, good quality cable with large enough conductor cross-section.



**Risk of electric shock or fire-
Avoid additional plug adapters.**

Bad quality adapters can be inadequately protected against dust and water. Some can even leave the pins of the plug exposed, creating a serious risk of electric shock. Never use plugs that leave the grounding wire unconnected.

Contact a local licenced electrician to replace the plug if necessary.



**Risk of battery overheating and fire -
Use only the built-in charger of the loader to ensure correct charge cycle.** The current and voltage output are optimized in the integrated charger to ensure quick charge and long life of the battery. Modified or different type of charger can overheat the battery or cause sparks, creating fire. Too high current or voltage will boil the electrolyte of the battery, potentially releasing battery acid.

Drive while charging

The charging system allows to operate the loader during charging. Make sure that the cable will not get entangled or pulled during use of the loader.

Charge time can be long while using the loader at the same time. At heavy load, the battery can even discharge, even if charger is connected to mains outlet.

Battery maintenance - water refill

The battery is a flooded type lead acid battery. Some of the water of the electrolyte in the battery is evaporated during charge. To keep the electrolyte level at sufficient level, additional purified battery grade water must be added to the battery regularly.

Check the need of water replenishment and add if necessary **after** the battery is fully charged.



Before you handle the battery, see safety instructions about handling the battery on page 14.

Battery water level indicators

To indicate the need for water, on top of each of 24 battery cells there is a float indicator.

- If there is sufficiently water in a battery cell, a white float will be at the top of the check window.
- In case the white float is not at the top of the check window on any of the battery cells, do a water refill procedure.

In the picture below:

- Left side: White float is at the top. If all battery cells are like this, no water needs to be added.
- Right side: Battery water must be added. Connect watering coupler to add water to the entire battery.

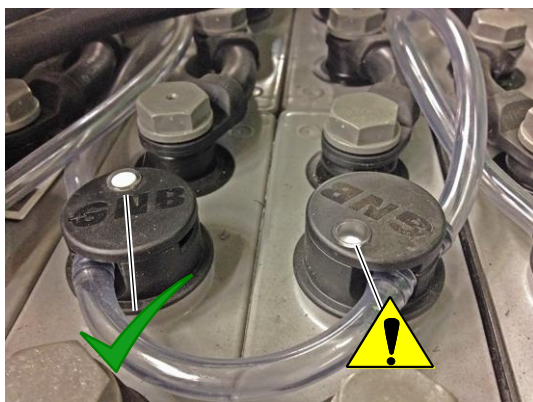

NOTICE

Always check the electrolyte level indicators after the battery is fully charged. Add battery grade water if any of the float markers is not at top. Never operate the loader if all battery cells are not filled properly, battery may become damaged and lose some of its capacity.



Risk of burns from acid spill - Never attempt to remove the caps of individual battery cells.

Individual battery cells must never be fully opened. Instead, there is a quick hatch on top of each cap, with a place to fit an instrument to measure the specific gravity of electrolyte inside cell. To avoid hazardous spill of acid, the battery pack must be watered by using the common, integrated water system, and test sample of electrolyte must be taken through the quick opening.

Battery watering system

A watering system to fill battery pack with water is supplied with the loader. The watering system consists of the following parts:

Description		
1	Water tank	
2	Cap with shut off valve	
3	Flow indicator	
4	Tank breather cap	
5	Quick connector, connects to counterpart on battery pack	

NOTICE

Make sure the watering container is lifted to at least 2-3 metres above the top surface of the battery. This ensures that there is enough pressure for the water to flow into all battery cells.

NOTICE

To ensure that water is added to all battery cells, add water while the loader is on level ground.

NOTICE

Never use tap water or bottled drinking water to fill batteries.

Use only purified water that is intended for battery use. Store water carefully to avoid its contamination. Tap and even the purest bottled drinking water contains minerals and other impurities that will spoil the battery quickly.

If you are unsure about the water, check that the distilled water complies with standard DIN 43530 part 4 and that the container is marked accordingly.

Battery watering connector on battery pack

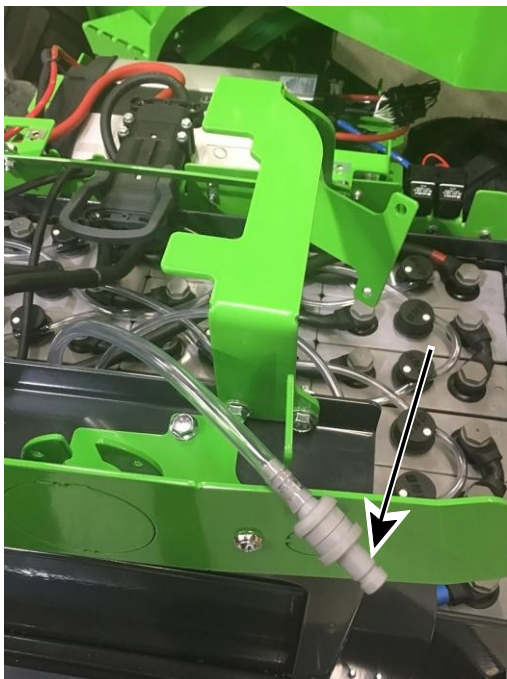

Find the hose and connector for water fill system on top of the battery. Connect the quick connector of watering system to this counterpart.

Watering procedure

The battery pack is fitted with watering connector which allows to add water to all battery cells from a single point.

The water container must be lifted high enough from the ground. Recommended height for the water tank is 2-3 metres higher than the top of the battery surface. This ensures that the water pressure will be high enough that all battery cells will be filled.

A breather cap on water container must be opened, so that water can flow freely.

1. Clean the water hose connectors of the battery and the watering system.
2. Connect the watering connector to the quick connector on the battery. Water will start to flow, and the flow indicator on the hose will spin.
 - Use only purified battery water. Even the cleanest drinking water contains enough dissolved minerals and impurities to damage the battery.
3. When the indicator stops, the battery is fully watered.

Watering may take up to 5 minutes to complete.

Watering system in freezing temperatures

If you store the loader in a cold place, where ambient temperature drops below 0°C, the water of the watering system can freeze. In case the watering system gets frozen, take the loader to a warm place and allow the system to melt. Freezing of the watering system will not cause additional damage.

For the best current capacity, it is recommended to use and store the loader in temperatures between +10°C and +30°C.

Never add any additives to battery.

Risk of acid spill - Add only pure battery water



Never add battery acid to the battery. Only water is evaporated during charge cycles. Addition of any other substance than water can react chemically and spill corrosive acid.

Service and maintenance



Risk of personal injuries - If the loader is damaged or poorly maintained it can cause or increase risks of unsafe operation.

To ensure long service life it is important to maintain the loader in good condition. The maintenance procedures listed in this chapter can be performed by trained or otherwise experienced operators. If you are not sure about how to do any service operation, ask for additional information before you start any service or maintenance work.

If the maintenance schedule is not followed, and services made are not marked in the table in this manual, the warranty may not cover for damages of the loader.

Service parts are available through your Avant dealer or authorised service. Contact your local Avant service or dealer for any questions or information.

Safety instructions



- Switch off the loader and let it cool down before starting any service operation.
- Put the service support on the boom lift cylinder when working under the boom. Keep boom lowered otherwise.
- Install the frame lock when lifting the machine, and, for instance, when changing tyres.
- Before working on the electric system or battery, disconnect the battery.
- Check hydraulic hoses for cracks and wear. Follow the wear of the hoses and stop operation if the outer layer of any hose has worn out. If there are signs of oil leakage, put a piece of cardboard under the probable leakage place in order to find the leakage. Never use hands to search for leaks, read instructions in this manual about safe handling of hydraulic components. If you find a fault, the hose or the component must be replaced.
- Contact your Avant dealer or service for spare parts.



Risk of burns, cuts, and sprayed oil or dirt - Use Safety goggles and gloves during all maintenance operations. Always wear protective gloves, safety goggles and protective clothing. Hot surfaces and sharp edges can cause injuries. Also general skin contact with oil and grease can be harmful, wash hands thoroughly after contact with oil.





High-pressure ejection of fluid may penetrate skin and cause serious injuries. - Never handle pressurised components.

Before handling hydraulic components, make sure that the hydraulic system of the attachment and the loader are completely depressurised. Do not hold your hand near a fitting when tightening or opening it, and never use hands to search for leaks. If a leak is suspected, set a piece of cardboard to detect a leak.

Seek medical attention immediately in case hydraulic fluid is injected through the skin. Also skin contact with the oil can be harmful, wash hands thoroughly after contact with oil.



Falling of load - Risk of crushing



Always secure the loader boom with the provided service support, before going under the loader boom. Remove any load and attachments from the loader before service or maintenance.



Risk of injury from injected hydraulic oil and burns - Never operate loader or attachments if there are hydraulic leaks.

Check hydraulic hoses and components only when the loader is safely stopped and hydraulic pressure is released. Repair all leaks as soon as you have noticed them, because a small leak can quickly change into a big one. Leaking hydraulic fluid can cause serious personal injuries and is also harmful to the environment.

Access to electric motor compartment

WARNING

Risk of burns - Allow loader to cool before opening covers.

Electric and hydraulic parts may be extremely hot after use.

The adjacent warning label is located visibly below the rear cover. Hot areas include the hydraulic components and hoses, and surfaces of electric motors and inverters.



Consider the environment



The fluids in the machine are harmful to the environment. Never allow fluids to leak in the environment.

Take waste oil and fluids to recycling station. Find out about your local requirements concerning the recycling or disposal of other components.

Installing of service support and frame lock

Installing boom service support:

The red service support of the boom lift cylinder is located at the tip of the boom, behind the attachment coupling plate.

Make sure that the boom stays up during maintenance operations by putting the service support on the lift cylinder piston rod. Secure the service support by locking it on the piston rod with the long screw that is on the support.

Service support stored at the tip of the boom

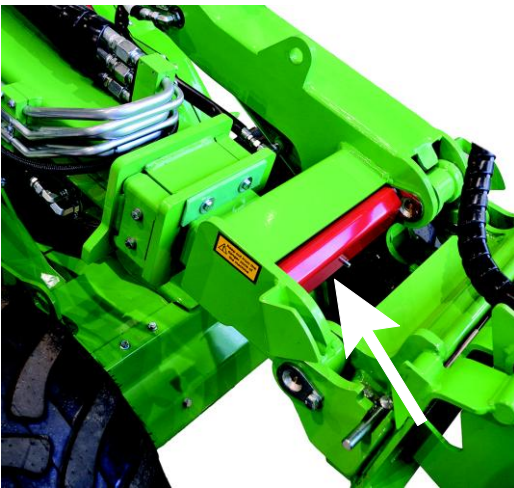

Service support in place



Frame lock:

A red frame lock bar is stored under the operator's cab.



This lock bar is intended to lock the articulated frame to make the loader frame stay straight during e.g. lifting or transportation.

The holes for the frame lock bar are on the left side of the loader, below the access step.

1. Slide the hook type end of the bar through a hole on the rear frame of the loader.
2. Turn the bar towards the front hole. The other end should remain locked in the hole on the rear frame.
3. Align the holed end of the bar and the frames by turning the steering wheel. This can be done without starting the loader.
4. Once aligned, slide the bar and lock with its cotter pin.



Daily inspections

Do a walk-around check of the loader before each working shift. Check at least the following points. Do not use the loader if you notice problems with any of the listed items.

Check before start		To check
1	Tyres: pressure and condition	<ul style="list-style-type: none"> ■ Check visually daily. Do not use if there is visible damage on tyres. ■ Check with pressure gauge if wrong pressure is suspected, see page 73
2	Level of hydraulic oil	<ul style="list-style-type: none"> ■ Check level of hydraulic oil especially after using a new attachment that drains hydraulic oil from the loader as the hydraulic system of the attachment fills up. Check also after repairing a leak.
3	Need for lubrication	<ul style="list-style-type: none"> ■ Make sure all joints are lubricated sufficiently, see page 76
4	Cleanliness of electric motor compartment and radiators	<ul style="list-style-type: none"> ■ Keep inner compartment of the loader clean to prevent electric motors and systems from overheating ■ Check and clean external surfaces of electric motors, inverters, and charger. Use damp cloth for cleaning ■ Dust, hay, and other dry materials inside the inner compartment will cause a fire hazard
5	Clean and check the battery	<ul style="list-style-type: none"> ■ Keep the top surface of the battery clean ■ Check the battery cables, connectors, and terminals visually. If a cable or its insulation has become brittle, there is a risk of short-circuit. Replace cables and insulators as necessary ■ In case of any trouble, or if you need more information, contact your Avant dealer
6	Oil or other leakages	<ul style="list-style-type: none"> ■ Check the underside of the loader. Also check ground/floor surface for signs of leakage ■ Never operate if leakage is observed. Repair before use
7	General condition of the loader	<ul style="list-style-type: none"> ■ Check for damages on metal parts or rust ■ Ensure all safety decals are in place and legible
8	Condition of the safety frame, seat belt, lamps, and other safety equipment	<ul style="list-style-type: none"> ■ Safety frame (ROPS) and protective roof (FOPS) must be fitted ■ Safety structures must not have visible damage or deformations. They must be replaced after any incident ■ Make sure all lamps are functional and clean
9	Attachment and its locking	<ul style="list-style-type: none"> ■ Check the locking of attachment and locking pins on attachment coupling plate ■ Function of attachment, position of attachment hoses ■ See also the operator's manual of the attachment, see page 4

Check after starting the loader		
11	Drive control and steering	<ul style="list-style-type: none">■ Check operation of pedals and steering after start. Pedals must move freely and not get stuck or feel stiff■ Check that loader stops when not pressing the drive pedals. Do not use the loader if braking performance is decreased or if the loader creeps■ Allow the loader to warm up and check steering
12	Boom movements	<ul style="list-style-type: none">■ Boom should move smoothly to all extreme positions when using without an attachment■ If attachment is fitted, check that the boom moves smoothly within its normal operating range■ Hydraulic hoses or electric cables must not get pinched or stretched in any position of the boom

Maintenance schedule

Following tables show the maintenance and service points and intervals of the loader. There are more detailed instructions about each service operation, in numerical order, on the following pages.

Part A - Loader		Every week	After first 50 h	Every 400h / year
1	Clean the machine	●	■	■
2	Grease the greasing points	●	●	●
3	Check tyre pressure	●		
4	Check tightness of bolts, nuts and hydraulic fittings	■	●	●
5	Check hydraulic oil level	●		
6	Change hydraulic oil filters		●	●
7	Change hydraulic oil		●	●
8	Clean cooling fans and surfaces	■ ¹	●	●
9	Adjust or replace the slide pads of telescopic boom	● ²	■ ³	● ⁴
10	Check pressure of hydraulic system		●	●
11	Adjust pressure of hydraulic system		■	■

¹ Depending on operating conditions. Daily check may be needed

² Check slide pads 1 to 4 on the boom

³ Adjust or replace slide pads 1 and 2

⁴ Check all slide pads and replace if necessary

- Maintenance operation
- When necessary

Part B - Battery		Daily	Every week	Every month	Every 400 h / year
1	Recharge battery	●			
2	Refill battery water level	■	●		
3	Ensure full charge		●		
4	Clean battery	■*	●		
5	Check battery visually Check all cables and insulators		●	●	●
6	Check battery capacity and all individual cells				●

Loader maintenance

1. Cleaning of the machine

Cleanliness of the loader is not only a question of outer appearance. All surfaces, painted and others, will stay in better condition when they are cleaned regularly. A dirty machine will run hotter and can cause poor performance, shorter battery life, or stopping of loader to overheat.

Pay special attention to the cleanliness of the battery, electric motors, inverters, charger, the hydraulic pump compartment, hydraulic quick couplings and the oil tank cover.

The outer surfaces of the loader can be carefully washed with a pressure washer. Never use pressure washer to clean the inner parts of the loader or the battery, electric parts may become damaged. Also, wash the hydraulic components (hoses, cylinders), any electric component, decals, and the radiators carefully, never with high pressure washer.

There is a service hatch on the loader to help with the cleaning of the rear frame. Reinstall the cover plate after cleaning to protect the internal components of the loader.

Clean cab interior with appropriate mild detergent and cleaning supplies.

After washing grease all greasing points.

NOTICE

The loader is equipped with a hydraulic oil cooler, which is located at the right side of the loader, near the controls of the loader. Make sure to clean the oil cooler cell with compressed air every time you are servicing the loader - and even more frequently if the loader is being used in dusty conditions.

NOTICE



Never spray the battery or electric motor compartment with a pressure washer. Battery and electric connectors and insulators may get damaged. Use cool or warm water to use other parts of the loader, never use hot water (above 70°C).

2. Greasing of the machine

Greasing of pivot points is very important to avoid wear. Most of the greasing points are on the loader boom. The following table and pictures show the location of grease nipples.

Suitable lubrication interval depends heavily on operating conditions. The need for lubrication must be checked at least after every 10 hours of use. Add grease if the joints have become dirty. Adequate lubrication of the joints must be ensured. Lack of lubrication will cause the joints to wear quickly.

Use general purpose machine grease. A grease gun is needed to apply grease to grease nipples. All lubrication nipples are standard R1/8" nipples. Replace any damaged nipples.

Clean the end of the nipple before greasing and add only a small amount of grease at a time. New lubricant will push out dirt from joints. Wipe excess grease with a cloth.

Greasing points are listed in the following table.

Reference		Number of points	
A	1.	Articulation joint Left side of loader	2
	2.	Steering cylinder Both ends of steering cylinder, near articulation joint	2
B	3.	Boom pivot pin Both ends of boom pivot	2
	4.	Lift cylinder	2
	5.	Levelling cylinder If fitted. Lower end accessible under front cover.	2
C	6.	Telescopic boom Grease when boom is completely retracted	2
D	7.	Tilt cylinder	2
	8.	Attachment coupling plate Pivot pins and tilting mechanism	5

A. Articulation joint and steering cylinder

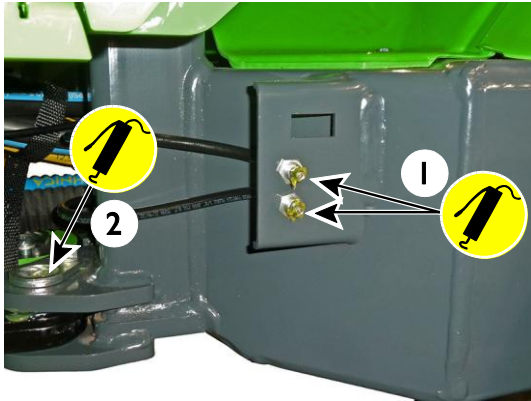

B. Front frame

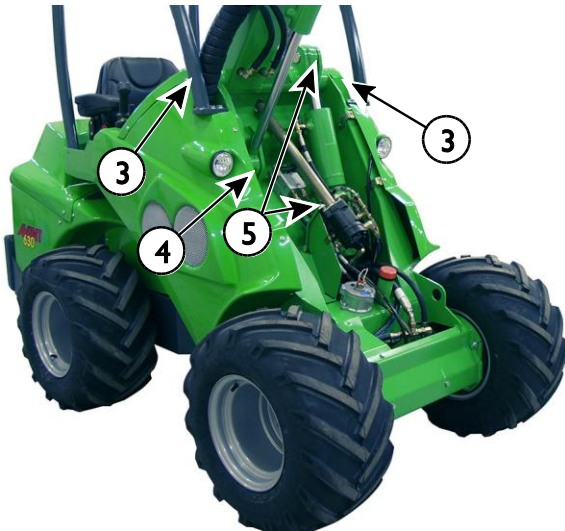

C. Telescopic boom



D. Coupling plate

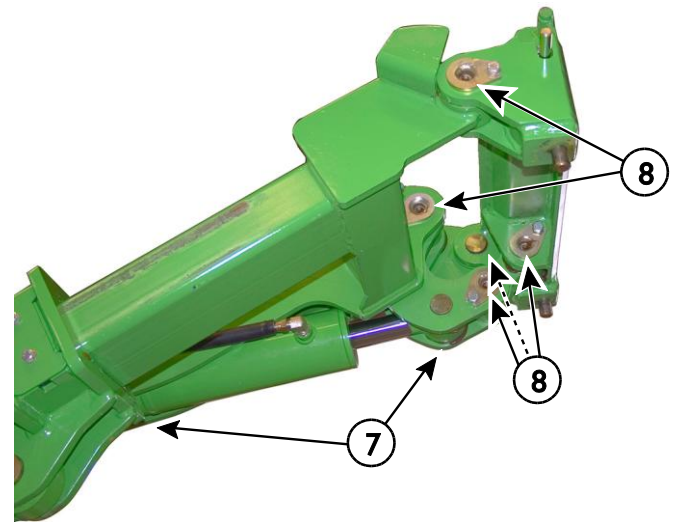

3. Tyre pressure check

Check tyre pressure when heavy attachments and extra counterweights are not attached. Correct tyre pressure depends on intended load. Refer to Chapter Technical Specifications.

4. Check and tightening of bolts, nuts and fittings

Check tightness of bolts, nuts and hydraulic fittings regularly. However, do not overtighten; tighten hydraulic fittings only if necessary.

Wheel nuts should be tightened 150 Nm.

Check the tightness of the pivot pin locking screws, if loose tighten and use thread locker.

NOTICE

Tighten wheel nuts after first 5 operating hours. Check tightness of wheel nuts regularly.

5. Hydraulic oil level

Hydraulic oil level can be checked with the dipstick in the filler. Lock the boom with boom service support to access the filler opening.

Oil level should be approximately at the lower mark of the dipstick (1) when the loader boom is up.

Tighten the dipstick on its threads for measurement. Refill when necessary, but never exceed the upper limit mark (2). Doing so can cause oil to overflow when lowering the boom.

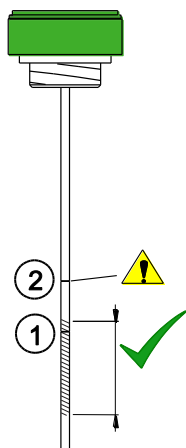

1. Target marker. Fill to this mark when hydraulic system is **cold**.

The area highlighted in the adjacent figure shows approximately the acceptable level.

2. The second mark on the dipstick indicates max level of hydraulic oil. Oil can reach this level when hydraulic system is **hot**.

Never overfill the hydraulic oil tank. Oil can flow over, or foam inside tank.

6. Hydraulic oil change

When changing hydraulic oil, the oil can be removed with a suction pump from the filler opening, or by removing the drain plug on the right side of the front frame, close to the articulation joint. In both cases it is important to clean the magnetic drain plug. Hydraulic oil tank capacity is 36 l.

Hydraulic oil type

Always use correct type of clean, high quality ISO VG-46 certified mineral hydraulic oil. If ambient temperature is hot, higher viscosity oil may be required, contact dealer.

In freezing temperatures use oil designed for the purpose, in order that the machine operates as intended and starting is easier.

NOTICE

Use of synthetic or bio hydraulic fluids may cause premature wear or damage to the hydraulic components and is not permitted. Using wrong type of hydraulic oil will void the warranty.

7. Changing of hydraulic oil filter

The loader is equipped with a hydraulic oil return filter. It is located on top of the hydraulic tank, next to the dipstick. Take off the cover and replace the oil filter cartridge. Dispose used filters as instructed by your local authorities. Never throw oil filters in general trash.



Filters - list of filters

Filters for Avant e5	
Hydraulic oil return filter	74093

8. Clean cooling fans and surfaces

There are total of three cooling fans on the loader:

- Hydraulic oil cooler
- Electric motor compartment and battery cooling fan
- Cooling fan in charger

All of these must be kept clean to ensure reliable operation and long service life of the loader.

In addition, clean the outer surfaces of the charger, inverters, and electric motors. Use damp cloth to wipe them clean. Never clean during recharge to avoid the possibility of creating sparks.

If operating the loader in dusty conditions, the cooling fans and surfaces must be cleaned more frequently.

NOTICE

Proper cooling is essential. To prevent overheating, clean screens, cooling fins, and external surfaces of electric motors, inverters, and the charger. Avoid spraying water at wiring harness or any electrical components.

9. Adjust and replace slide pads of telescopic boom

The telescopic boom is equipped with replaceable slide pads. The slide pads are wear parts that wear during the use of the telescopic function. All slide pads can be replaced, and the nylon slide pads on the outer boom can also be adjusted. Adjustment or replacement of the slide pads is necessary to compensate for wear and to adjust the play between the outer and inner telescopic boom.

- At the lower end of the outer boom there are pairs of nylon slide pads 1 and 2, accessible from around the boom.
- In addition, there are pairs of aluminium-bronze alloy slide pads 3 and 4, at the upper end of the inner boom. To access pads 3 and 4, the boom parts must be separated.

Slide pads 1 and 2

Slide pads 1 and 2 can be adjusted by mounting thin adjustment sheets between the boom and the slide pad.

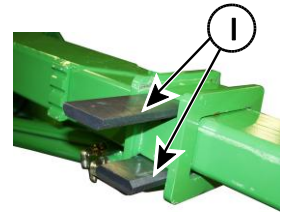

Extend the telescope almost completely and press the boom gently against the ground. This way it is the easiest to mount an adjustment sheet under lower slide pad 1.

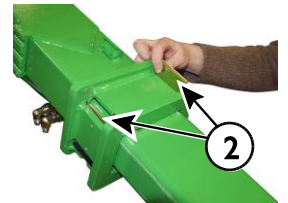

However, if there is substantial wear in the slide pads it is advisable to replace both pads 1.

Slide pads 3 and 4

Slide pads 3 and 4 at the upper end of the inner boom last long in normal use. They should be checked after every 400 operating hours and replaced at least after 800 hours of use.

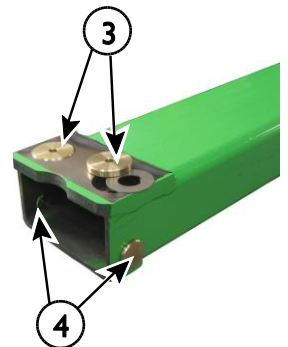

To check these slide pads, take the inner boom completely out of the outer boom. If the pads have worn so much that they are in level with the boom, or excessive boom play can't be removed by adjusting slide pads 1 and 2, replace all slide pads.

NOTICE

To replace slide pads 3 and 4 the boom must be partially disassembled. Lifting equipment is required in order to do the service safely. It is recommended to leave this service operation to your nearest Avant service partner.

Slide pad part numbers	
Slide pad 1	A48339
Adjustment sheet, long:	A48014
Slide pad 2	A412868
Adjustment sheet, short:	A412971
Slide pad 3	A47922
Spacer under slide pad 3	A47941
Slide pad 4	A48343

10. Check pressure of hydraulic system

Pressure of the boom and auxiliary hydraulics are measured from the auxiliary hydraulics multiconnector. It is recommended to leave the checking operation to qualified service technicians. At minimum, a hydraulic pressure gauge with appropriate measurement scale and a measurement fittings are required. See picture for measurement set up.

The main pressure relief valve for the auxiliary hydraulics pump is located on a valve block at the rear frame of the loader. However, the pressure of the boom and auxiliary hydraulics is adjusted from the boom control valve. The main pressure relief valve must not be adjusted. If boom pressure can't be adjusted high enough from the boom control valve, the pump and main relief valve must be checked. Contact Avant service.



WARNING

Risk of injection of hydraulic oil - Wrong handling of the hydraulic system or wrong tools can cause ejection of hydraulic oil. It is recommended that pressures should only be checked or adjusted by a competent and experienced technician. Contact your AVANT dealer if you need assistance.

NOTICE

Never adjust pressure to higher level than recommended setting. The electric drive system is designed to operate at the intended pressure level. Other settings can damage electric drive, modify the response of the controls, and decrease battery life. Warranty will not cover for damages caused by wrong pressure setting. Never remove tamper resistant seals from pressure relief valves.

Pressure measurement from multiconnector

To connect a pressure gauge, you need at least the following fittings, shown in the figure:

1. 64743
2. 64194

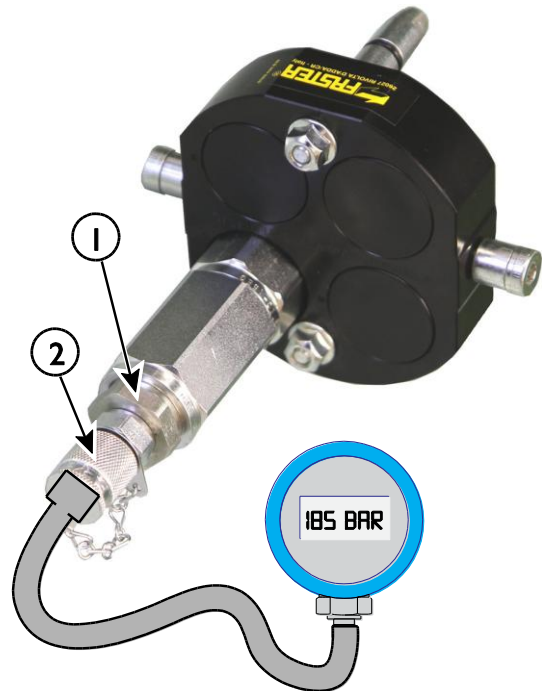

Boom control valve

There is a pressure relief valve on the control valve assembly. This is shown in the picture below. Adjust boom and auxiliary hydraulics from this valve so that the pressure gauge fitted to auxiliary hydraulics outlet shows the correct pressure (18,5 MPa (185 bar)).

1. Loosen and remove the locking nut
2. Turn the adjustment screw below it with an allen key.
Turn only with small increments, max 1/8 rounds at a time.
3. Check pressure after each adjustment.
4. Check pressure once again after tightening the securing cap nut back.

Never attempt to adjust boom pressure from the main pressure relief valve located at the rear frame. Contact service if you suspect that the main pressure relief valve might be damaged or wrongly adjusted.

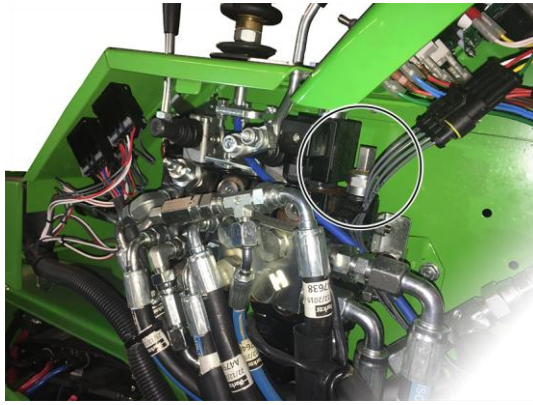

Drive pressure:

Drive pressure needs to be checked only if there is a clear indication of reduced traction force of the loader.

NOTICE

Drive pressure check is recommended only for experienced service professionals. Special instruments are required.

To check the pressure in the drive circuit, you need to install a pressure measurement fittings to the drive pump valve block. Pressure gauge with a minimum range of up to 400 bar is needed.

If pressure seems to be clearly wrong, your nearest service provider can test the operation of two pressure relief cartridges which have fixed pressure setting. Also the hydraulic drive motors, drive pump feed pressure, and brake release pressure should be checked when investigating drive system related troubles.

11. Adjust pressure of hydraulic system

If the pressure check of boom and auxiliary hydraulic systems indicates that the pressure is wrong, it can be adjusted only in case the adjustment is not sealed.

Pressure adjustment screw is locked with a nut, loosen the nut first. Adjust the pressure incrementally with an allen key. Turn max. 1/8 rounds at a time and check pressure again. See pictures for pressure adjustment points.



Never exceed the recommended hydraulic pressure settings. Excessive hydraulic pressure may lead to hydraulic oil ejection by hose burst or component failure. Wrong adjustment will damage or wear the hydraulic pumps, cylinders, and hydraulic motors. Warranty does not cover damages caused by excessive hydraulic pressure.

Drive pressure:

Cannot be adjusted by user. If the pressures are clearly wrong, the pressure relief cartridges with fixed pressure setting must be replaced. Contact service for correct parts.

Battery maintenance

Battery connector

In addition to the automatic main switch, also disconnect the battery if the loader will not be used for a longer period of time, or when servicing the machine. The battery pack can be disconnected manually from the loader by disconnecting the main battery cable.

Pull the connectors apart from each other fully disconnect battery. Disconnect battery in at least the following cases:

- before you do any maintenance that requires access near electric motors or other main electric parts
- before maintenance of any electric component
- before you disconnect any electric cable
- there is a risk of fire
- when loader is being transported
- there is visible mechanical damage on battery
- you plan to store the loader for long storage period.

1. Recharge daily

Recharge battery after each time loader is used. Also partially drained battery must be recharged. This ensures maximum life of the battery.

Check battery water level after each charge cycle and add water if necessary. See page 63 for charge and water instructions.

2. Refill battery water level

After each charge cycle, check the level of electrolyte in battery cells from the float caps. Add battery water as described in page 63.

3. Ensure full charge

To balance the charge between all individual battery cells, do a full charge at least weekly. Allow the charger to be plugged in until the green indicator light is lit. The balancing charge is made at the end of charge cycle. It is recommended to do the full charge as often as possible.

4. Cleaning of battery

The battery should always be kept clean and dry to prevent so called leakage currents between battery cells. Any dirt or liquid on the battery can cause current to flow between battery cells. This will cause discharge of individual cells and poor overall performance of the battery pack.

Any liquid on the battery or in the battery tray must be considered as acid and necessary precautions must be taken. Wear safety gloves that protect from contact with acids. Use preferably a suction system to remove any liquid on battery. Dispose materials use for cleaning in appropriate manner.

During battery recharge, small quantities of electrolyte particles escape and form a weakly conductive layer on the cell covers. Leakage current flows through this layer then, leading to increased and varying self-discharging. If suspecting that battery capacity is weakened after weekend storage, this dirt can be the cause.



Risk of sparks, fire, and explosion - Dirt on battery can cause current to flow between battery cells. Dirty battery can cause short-circuit of battery cells and sparks. This can be a source of ignition for gases produced during charge. Clean the top of the battery before recharge. Never clean during recharge to avoid sparks caused by static electricity.



Risk of battery damage and acid spill - Never use pressure washer to clean the battery. Pressure washer can damage the battery cells or the caps on top of the battery, allowing water to enter battery. This will result in battery damage, and can also cause battery electrolyte (acid) to spill from battery. Clean battery as instructed in this manual.

Cleaning procedure



Risk of acid burns - Wear personal protective equipment when handling battery. Wear safety goggles, gloves, and protective clothing when cleaning the battery. Electrolyte that has spilled or evaporated from the battery can be acid.

The plastic parts of the battery may only be cleaned with water or water-soaked rags without additives. After cleaning, the battery surface must be dried by suitable means, e.g. with compressed air or cleaning cloths. Hot air devices with open flame or glow wires must not be used.

The battery base is sealed and will collect water. If liquids are on battery drain tray, keep in mind that any liquid must be extracted by suction, handled as acid, and disposed of correctly. There are a few small solid plastic tubes in between the battery cells to reach the bottom of the battery tray with a suction device.

Observe the local regulations relating to the use of water and treatment of waste. Never allow washing water to drain into the environment.

5. Check battery visually

Check the battery, all cables, and insulators visually for signs of dirt and mechanical damage. Search for the following:

- Dirt or dust on battery or between battery cells
- Dirt around battery and between battery and its metallic tray
- Liquid leakages on battery, between cells, or on battery tray
- All cables, cable insulators, cell caps, electrolyte level indicators, watering system tubes and connectors

Dirt that gets between the cells or the battery tray can cause wear of the battery cells. If battery gets worn enough, so that insulation from each other or from external conductive parts can be suspected, battery must be taken off from service and replaced.

6. Battery condition tests



Risk of electric shock, sparks, fire, and explosion of battery - Tests listed here are intended for experienced operators and service professionals. Use proper instruments and personal protective equipment when you do condition tests.



Risk of electric shock, sparks, and fire - Follow correct procedure to measure currents. Never attempt to measure current by connecting a multimeter or similar directly between battery poles. This wrong method can, at minimum, destroy the metering device, and also cause sparks, fire, or electric shock. Know how to measure electric systems or contact your local service point.

The output voltage of the battery in unloaded condition tells only part of the status of the battery. The individual cells may have become damaged so, that they output nominal voltage without load, but voltage drops significantly when current is drawn from the battery.

If individual cells are damaged, the performance of the loader can be reduced significantly. Individual cells of the battery can be replaced by your nearest authorised Avant or Exide service partner. However, some basic tests are described here to help with logging the condition of the battery and with troubleshooting.

Insulation resistance test

At least once per year, the insulation resistance of the loader and the battery must be checked by an electrical specialist. The tests on the insulation resistance of the battery must be conducted in accordance with standard EN 1987-1.

The insulation resistance of the battery thus determined must not be below 2400Ω (50Ω per Volt of nominal voltage), in compliance with EN 50272-3.

Test electrolyte condition and record results

After charging has ended the specific gravity and the temperature of the electrolyte in all cells should be measured and recorded.

If significant changes from earlier measurements or differences between the cells or bloc batteries are found further testing and maintenance are required. Contact service.

Test of condition of each individual battery cell

Measurement of the output voltage at rest of total battery pack or individual cells will not give accurate result of the condition of the battery. For more accurate results and troubleshoot, measure output voltage of each cell under load.

To test, operate the loader under heavy load. Lock auxiliary hydraulics to ON without an attachment at high motor rpm to apply load.

Use a voltmeter and measure each individual cell. Write down output voltage of each cell under load and at idle. Those that have lower voltage output under load are likely damaged and need further investigation.

Nominal density of electrolyte*	
Fully charged battery	1,29 kg/l
Completely discharged battery	1,13 kg/l

* Temperature affects measured specific gravity of electrolyte. Therefore the temperature of electrolyte at the time of measurement must be recorded. Correlation factor is -0.0007 kg/l per °C.

1.28 kg/l at 45°C corresponds to a specific gravity of 1.29 kg/l at 30°C

Replacing battery pack

To remove the battery pack from the loader, use lifting equipment capable of lifting the entire battery pack. Never remove individual cells of an installed battery. The battery must be replaced as a complete assembly. Replacing individual cells without full analysis of the condition of all battery cells can cause the new replaced cells to get damaged quickly.



Electric system & fuses

The e5 loader is equipped with 2 electric systems:

1. The 48 V high current system for electric motors

This system controlled by the inverters, there are no separate fuses

2. Regular 12 V electric system for all instruments and controls

- Two fuse boxes at the front of the loader
- Main fuse box after 48 V to 12 V DC-DC converter at rear left of the loader:
 - 10 A fuse before DC-DC converter
 - 7.5 A fuse for the ignition key circuit

In the event of electric malfunction, always check the two 12 V system fuse boxes first. If a fuse is blown repeatedly, search for cause of burning fuse. Electric cables may be damaged. Contact service.

WARNING

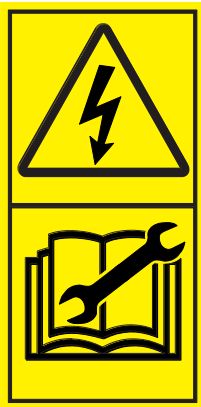

Risk of high-current electric shock, fire, and explosion of battery - Never repair or modify the 48 V electric system. Contact with high-current parts of the electric system can cause a potentially lethal electric shock, regardless of the relatively low voltage. Contact authorized service in case of trouble with the electric drive system.

Main fuse boxes of 12-volt system

There are two fuse boxes located outside the cab, on the right side of the loader boom.

Lift the boom first for easier access to the fuses, if possible.

Remember to use the service support. If the boom cannot be lifted, the fuses can be checked after removing the right side cover plate.

Hydraulic oil cooler fan fuse

The red indicator on the dashboard indicates blown hydraulic oil cooler fan fuse. If the indicator is lit, check the 10 A fuse of the oil cooler fan. Check the cooler fan can rotate freely and is not blocked. Contact Avant service if necessary.

12 V Fuse box 1

1	25A		Hydraulic oil cooler fan fuse
2	10A		Dashboard, instruments Signal horn
3	30A		Standard work lights 12 V electric outlet
4	20A		Boom floating
5	25A		Windscreen washer and wiper Cooling fan for electric system and battery pack
6	25A		Electric joystick switches Seat heater

12 V Fuse box 2

1	25A		Warning beacon Continuous 12 v of attachment control switch pack
2	25A		Road traffic light kit
3	20A		<i>not in use</i>
4	10A		Parking brake (release) Drive mode / drive speed range selection switch
5	30A		Switches of attachment control switch pack
6	15A		Extra work light kit Selection switch of hydraulic flow to extra front or rear couplings

Ignition switch fuses

The ignition switch controls the main switch of the loader by a separate electricity circuit. If the loader does not respond to ignition switch, even if battery is charged, check the two fuses in the fuse box that is located in the rear left side of the loader.



Inverter diagnostic codes

The loader is controlled via CAN bus system. The two electric motor controllers check the electric motor related systems during start-up of the loader.

In case the inverter that controls the auxiliary hydraulics pump has detected a fault requiring service, the multi function display will show a fault code. The multi function display can display fault codes stored by the electric motor controller of the auxiliary hydraulics pump. Any fault code related to the inverter of the drive pump will be displayed with LED lights on the side of the inverter.

The electric system may go into to fault mode, which will reduce power output to protect the battery and electric systems. If necessary, the loader can be driven to a safe location, but must not be loaded or used more than absolutely necessary. The loader must be checked and serviced by authorised service before continuing use.

Diagnostics fault codes

Fault codes may help diagnosing a problem when communicating with authorised service. If you see an error code message displayed on the multi-function display, for more information, contact your local Avant service. Detailed interpretation of fault codes and MIL reset require contact with service.

Codes start with the letter F and six numbers after it, such as F_____. The first number indicates the severity of the error type:

- F1 _____ is an information code, that warns about low battery or similar faults with low severity.

- F2 _____ and F3 _____ warn about functional faults, such as sensor errors or if a wrong sequence of controls is used. Restart of the loader may solve the issue.
- F4 _____ indicates a severe fault that must be repaired before continuing the use of the loader.

If there are multiple fault codes stored, the code for the most severe fault will appear on the display.

Light bulbs

- | | | |
|----|--------------------------|----------|
| 1. | Front lights | LED unit |
| 2. | Work lights | LED unit |
| 3. | Road traffic headlights: | H7 |

Metal structures of the loader



Contact Avant service in case the steel structure of the loader gets damaged. A faulty reparation, or wrong methods and materials used for reparation, can cause hazardous failures or further damage the loader.



In case the ROPS safety frame or the FOPS canopy of the machine gets damaged, the machine must be taken to Avant service for checking. It is not allowed to repair the ROPS and FOPS.

Troubleshoot

Listed below are possible causes for typical problems. In case you experience trouble with the operation of the machine, check troubleshoot lists first and if problem is not solved, contact your nearest service point or dealer.

Problem	Possible cause	Remedy
Electric motors won't start when turning the ignition switch	Driver not on driver's seat	Operator must sit on driver's seat to activate auxiliary hydraulics. Also, other operating mode can be selected to operate certain attachments from another control position, see page 46.
	Ignition switch fuse blown	The ignition switch controls also the electric main switch of the loader. There are two fuses for the ignition switch. Check all fuses, see page 85.
Hydraulic attachment does not work when the auxiliary hydraulics control lever is moved	Attachment hoses are not coupled or the multi connector is not fully locked	Make sure that the multi connector is properly connected.
	Faulty or damaged quick couplers (will restrict or stop oil flow)	Replace quick couplers in multi connector.
	Operator not seated on driver's seat	Operator must sit on driver's seat to activate auxiliary hydraulics. Also, other operating mode can be selected to operate certain attachments from another control position, see page 46.
	Fault in attachment	Check with another attachment, if possible.
Attachment hoses will not go into the extra front or rear quick couplers of the machine	There is back pressure in the auxiliary hydraulics line	Release the pressure by moving the extra auxiliary hydraulics control lever in both directions.
Hydraulic oil overheats	Control valve not fully open	Adjust the locking plate of the aux hydraulics control lever, see page 32.
	Dirty, blocked or faulty hydraulic oil cooler	Clean hydraulic oil cooler, check fan. Check fan fuse, temperature switch, and relay.
	Overload of hydraulic system	Allow to loader cool by leaving on idle, until hydraulic oil cooler stops. Avoid operating an attachment at extreme load continuously. Check that attachment is operated correctly, and no flow restrictors are left half open on hydraulic circuit.
	Low hydraulic oil level	Make sure hydraulic oil level is as shown on page 78.
Electric motors will not run	Battery discharged or damaged	Charge battery or start with separate battery. Check battery condition, replace if necessary.
	Operator presence control activated	Operator must sit on driver's seat to activate auxiliary hydraulics. Also, other operating mode can be selected to operate certain attachments from another control position, see page 46.
	Auxiliary hydraulics control lever is in locking position	Release the lever to neutral position.
	Blown fuse	Check all fuses
	Cold temperature	The current output capacity of the battery is reduced in extreme cold. Also, hydraulic oil becomes thick (viscous) in cold. Combined with low charge level the hydraulic motors may not start running. Take the loader to warm place to heat, and charge battery. Use high quality hydraulic oil.

Problem	Possible cause	Remedy
Drive works erratically and boom movements do not work at all, electric motors run	Low hydraulic oil level	Check hydraulic oil level and condition.
Drive and boom movements work erratically, motors run smoothly	Air in hydraulic components	Move boom and steering cylinders and hold at each extreme position to de-air the system. Check hydraulic oil level and condition.
Hydraulic oil pushed out from hydraulic oil filler cap, hydraulic oil foams	Leak in hydraulic suction line connecting tank and hydraulic pumps allows air to sucked in	Replace suction hoses.

Services made

1. Customer _____
2. Loader model _____ Serial number _____
3. Date of delivery _____

Date of service dd / mm / yyyy	Operating hours	Remarks	Serviced by: Stamp/signature
___/___/____	____/ 50 h		
___/___/____	____/ 450 h		
___/___/____	____/ 850 h		
___/___/____	____/ 1250 h		
___/___/____	____/ 1650 h		
___/___/____	____/ 2050 h		
___/___/____	____/ 2450 h		
___/___/____	____/ 2850 h		
___/___/____	____/ 3250 h		
___/___/____	____/ 3650 h		
___/___/____	____/ 4050 h		

Notes

Notes

Notes

EC DECLARATION OF CONFORMITY	DÉCLARATION DE CONFORMITÉ CE	EG-KONFORMITÄTS-ERKLÄRUNG
Manufacturer: Avant Tecno Oy Ylötie 1 33470 Ylöjärvi, Finland	Fabricant : Avant Tecno Oy Ylötie 1 33470 Ylöjärvi, Finlande	Hersteller: Avant Tecno Oy: Ylötie 1 33470 Ylöjärvi, Finnland
Technical Construction File Location: Same as Manufacturer	Emplacement du fichier technique de fabrication : Le même que celui du fabricant	Ort der technischen Bauunterlagen: Identisch mit Hersteller
We hereby declare that the machine listed below conforms to EC Directives: 2006/42/EC (Machinery), 2014/30/EC (EMC) and 2000/14/EC (Noise Emission).	Nous déclarons par la présente que la machine mentionnée ci-après est conforme aux directives CE: 2006/42/CE (machines), 2014/30/CE (CEM) et 2000/14/CE (émission de bruit)	Wir erklären hiermit, dass die nachstehend aufgeführte Maschine mit folgenden EG-Richtlinien in Übereinstimmung steht: 2006/42/EG (Maschinenbau), 2014/30/EG (EMV) und 2000/14/EG (Lärmemissionen).
Category: EARTH-MOVING MACHINERY / LOADERS / COMPACT LOADERS	Catégorie : ENGIN DE TERRASSEMENT/ CHARGEURS/ CHARGEURS COMPACTS	Kategorie: ERDBEWEGUNGSGERÄT/ LADER/KOMPAKTLADER
<i>Original language</i>	<i>Original language</i>	<i>Original language</i>

Model / Modèle / Modell: **AVANT e5** L

Serial Number / Numéro de série / Seriennummer:

Year of manufacture / Année de fabrication / Baujahr: **2016-2017**

Directive Directive Richtlinie	Conformity Assessment Procedure Procédure d'évaluation de conformité Konformitätsbewertungsverfahren	Notified body Organisme notifié Zugelassene Stelle
2006/42/EC	Self-certification	----
2006/42/CE	Autocertification	
2006/42/EG	Selbstzertifizierung	
2014/30/EC	Type-test	
2014/30/CE	Examen CE de type	
2014/30/EG	Baumusterprüfung	
2000/14/EC	Type-test	
2000/14/CE	Examen CE de type	
2000/14/EG	Baumusterprüfung	

	e5
Sound Power Level (guaranteed) / Niveau de puissance acoustique (garanti) / Schalleistungspegel (garantiert)	101 dB(A)
Sound Power Level (measured) / Niveau de puissance acoustique (mesuré) / Schalleistungspegel (gemessen)	100 dB(A)



_____ Ylöjärvi, Finland
Risto Käkälä,
Managing Director / Directeur général / Geschäftsführer

Index

A

Access to electric motor compartment - 71
 Adjust and replace slide pads of telescopic boom - 79
 Adjust pressure of hydraulic system - 81
 Allow the loader to warm up properly - 48
 Attachment control switch pack (optional extra) - 34
 Auxiliary hydraulics oil flow - 23, 24, 34, 56
 Avant warranty - 7

B

Ballasted tyres - 26
 Battery and Charging - 16, 31, 63, 65, 82
 Battery condition tests - 83
 Battery connector - 14, 82
 Battery disconnect switch - 45
 Battery life - 64
 Battery maintenance - 82
 Battery maintenance - water refill - 68
 Battery system in cold environment - 48
 Battery systems on e5 - 14
 Battery water level indicators - 68
 Battery watering system - 68
 Boom floating - 31, 39
 Boom self-levelling - 39

C

CAB L (optional extra) - 38
 Cab Safety - 38
 Changing of hydraulic oil filter - 78
 Charge process - 66
 Charger - 66
 Charger plug type - 66
 Charging the battery - 65
 Check and tightening of bolts, nuts and fittings - 77
 Check battery visually - 83
 Check pressure of hydraulic system - 80

Clean cooling fans and surfaces - 79
 Cleaning of battery - 82
 Cleaning of the machine - 76
 Control lever of auxiliary hydraulics (hydraulically operated attachments) - 32, 45, 61, 87
 Control lever of boom and bucket - 30, 32
 Control of loader boom, auxiliary hydraulics and other functions - 32
 Controls and options of the Loader - 30
 Counterweights - 40, 50
 Coupling adapters - 59
 Coupling the attachments - 57
 Coupling the hydraulic hoses of the attachment - 60

D

Daily inspections - 44, 73
 Dashboard - 31
 Dashboard e5 - 30, 31, 39, 66
 Description of the loader - 17
 Dimensions - 22
 Drive control - 46
 Drive pedals - 47
 Drive release and anti slip - 47
 Drive speed and pulling force - 24
 Drive while charging - 67
 Driving/operating modes - 47

E

Electric 12 V outlet - 30, 35
 Electric qualification - 6
 Electric system & fuses - 85
 Electric system and battery - 23
 Electric system and handling of the battery pack - 14, 65, 68
 Ensure full charge - 82
 Extra auxiliary hydraulics coupling - 62
 Extra auxiliary hydraulics outlet - 30, 41
 Extra work light kit (option) - 37

F

Filters - list of filters - 78
 Fire prevention - 13

First aid measures - 15
 Follow correct charging procedure - 15
 Foreword - 3

G

General safety instructions - 8
 General specifications - 23
 Greasing of the machine - 73, 76

H

Hand throttle lever for pump RPM control - 30, 34
 Handle battery with care - 14
 Handling of heavy loads - 50
 Height and width - 22
 How to estimate actual lifting capacity - 51
 Hydraulic attachment coupling - 30, 58
 Hydraulic oil change - 78
 Hydraulic oil cooler fan fuse - 31, 85
 Hydraulic oil level - 78
 Hydraulic oil type - 78

I

Ignition key - 44
 In case the machine tips over - 52
 Indicator lights - 31
 Installing of service support and frame lock - 72
 Intended use - 5
 Introduction - 3
 Inverter diagnostic codes - 86

J

Joystick - 6 function (optional extra) - 33

K

Keep this manual with the loader - 6

L

Lifting - 8, 54
 Light bulbs - 86
 Lights - 37
 Loader maintenance - 76

M

Main parts of the loader - 18
Main switch - 45
Maintenance schedule - 75
Make sure all relevant manuals are available - 4, 73
Material handling - 27, 33, 50
Metal structures of the loader - 86
Modifications - 12
Multi-function display - 30, 35

N

Notes - 90, 91, 92

O

Operating instructions - 43
Operation on uneven surfaces, gradients, and near excavations - 11
Operator presence control - 30, 34, 44, 46, 61, 87
Operator qualification - 6
OptiDrive™ - 47
Options - 39

P

Parking brake switch - 30, 35
Personal safety and protective equipment - 12
Preparation for charging - 65

R

Rated operating capacity - 29
Rear carrier - 41
Recharge - General principles - 63
Recharge daily - 82
Refill battery water level - 82
Releasing the residual pressure of hydraulic system - 8, 45, 62
Replacing battery pack - 84
Requirements for attachments - 56
Reverse buzzer (option) - 41

S

Safe stopping procedure - 45
Safety First - 8
Safety frame (ROPS) and safety canopy (FOPS) - 12

Safety instructions - 70
Seat - Seat belt and seat adjustments - 36
Seat adjustments - 36
Seat heater - 36
Service and maintenance - 9, 70
Services made - 89
Signs and decals - 19
Snow chains - 26
Starting the loader - 44
Steering of the machine - 49
Stopping the loader (Safe stopping procedure) - 45, 50
Storage - 55
Storage of electric loader - 55
Suspension seat - 36

T

Technical specifications - 22
Telescopic boom control lever - 30, 33
Tie down options - 54
Tie down points - 53
Tipping load - 27, 29, 33
Tipping load - load chart - 28
Tips to increase battery life - 45
To keep the battery in good condition - 64
To start the loader: - 45
Towing (retrieval of the machine) - 55
Trailer coupling - 40
Transport instructions and tie down points - 53
Troubleshoot - 31, 45, 87
Tyre pressure check - 77
Tyres - 25

U

Using the auxiliary hydraulics - 61

W

Warning beacon (option) - 30, 37
Watering procedure - 69
Wheel spacers - 25
When you want to have a high pulling force: - 47

Windscreen washer and wiper - 30, 38
Work lights - 37
Working near powerlines - 13
Working with attachments - 56



AVANT[®]

Avant Tecno Oy

Ylötie 1

FIN-33470 YLÖJÄRVI, FINLAND

Tel. +358 3 347 8800

e-mail: sales@avanttecno.com

AVANT has a policy of continuous development, and retains the right to change specifications without notice. © 2017 Avant Tecno Oy. All rights reserved.

www.avanttecno.com