



*People. Products. Productivity.*

## **OPERATING MANUAL**

**ERC040-065GH (A908)  
ERC030-040AH (B814)  
ERP040-060DH (D216)**

**PART NO. 524183077**

**1/06**

**DO NOT REMOVE THIS MANUAL  
FROM THIS UNIT**

---

LIFT TRUCK MODEL \_\_\_\_\_

SERIAL NUMBER \_\_\_\_\_

ENGINE MODEL \_\_\_\_\_

SERIAL NUMBER \_\_\_\_\_

TRANSMISSION TYPE \_\_\_\_\_

SERIAL NUMBER \_\_\_\_\_

MAST LIFT HEIGHT \_\_\_\_\_

GROUP NUMBER \_\_\_\_\_

CARRIAGE TYPE \_\_\_\_\_

GROUP NUMBER \_\_\_\_\_

DRIVE TIRE SIZE \_\_\_\_\_

STEERING TIRE SIZE \_\_\_\_\_

**SPECIAL EQUIPMENT OR ATTACHMENTS**

---

---

---

Yale® is a registered trademark of Yale Materials Handling Corporation in certain countries. Techtronix™, Techtronix 100™, Techtronix 200™, Veracitor™, Accutouch™, CSE™, EZ Tank™, Hi-Vis™, Intellix VSM™, Palmtech™, and Premier™ are trademarks of Yale Materials Handling Corporation in the United States and/or in certain countries where rights in unregistered trademarks are recognized. Yale Materials Handling Corporation products included in this document may be covered by U.S. Patent No. 6,684,148 and other U.S. and foreign patents pending. ©Yale Materials Handling Corporation 2006. All rights reserved.

---

## FOREWORD

### TO OWNERS, USERS, AND OPERATORS:

The safe and efficient operation of a lift truck requires skill and alertness on the part of the operator. To develop the skill required the operator must:

- Receive training, pursuant to OSHA 1910.178(1) dated 12/98, in the proper operation of THIS lift truck.
- Understand the capabilities and limitations of the lift truck.
- Become familiar with the construction of the lift truck and see that it is maintained in good condition.
- Read and understand the warnings and operating procedures in this manual.

In addition a qualified person, experienced in lift truck operation, must guide a new operator through several driving and load handling operations before the new operator attempts to operate the lift truck alone.

It is the responsibility of the employer to make sure that the operator can see, hear, and has the physical and mental ability to operate the equipment safely.

Various laws and regulations require the employer to train lift truck operators. These laws and regulations include:

Occupational Safety and Health Act (USA)

Canada Material Handling Regulations

**NOTE:** A comprehensive operator training program is available from YALE COMPANY. For further details, contact your dealer for YALE lift trucks.

This **Operating Instructions** manual contains information necessary for the operation and maintenance of a basic fork lift truck. Optional equipment is sometimes installed that can change some operating characteristics described in this manual. Make sure the necessary instructions are available and understood before operating the lift truck.

Some of the components and systems described in this **Operating Instructions** manual will NOT be installed on

your unit. If you have a question about any item described, contact your dealer for YALE lift trucks.

**Additional information** that describes the safe operation and use of lift trucks is available from the following sources:

- Employment safety and health standards or regulations (Examples: "Occupational Safety and Health Standards (USA)", "Canada Material Handling Regulations").
- Safety codes and standards (Example: American National Standard, ITSDF B56.1, *Safety Standard For Low Lift And High Lift Trucks*).
- Publications from government safety agencies, government insurers, private insurers and private organizations (Example: *Accident Prevention Manual For Industrial Operations*, from the National Safety Council).

- "Guide for Users of Industrial Lift Trucks" describes lift truck safety, good maintenance practices, and training programs. Available from your dealer for YALE lift trucks.

**NOTE:** YALE lift trucks are not intended for use on public roads.

**NOTE:** The following symbols and words indicate safety information in this manual:

 **WARNING**

Indicates a condition that can cause death or injury!

 **CAUTION**

Indicates a condition that can cause injury or property damage!

**CONTENTS**

<b>FOREWORD</b> .....	<b>1</b>	Service Reminder .....	41
TO OWNERS, USERS, AND OPERATORS .....	1	Status Codes .....	42
<b>CONTENTS</b> .....	<b>3</b>	Hourmeter .....	42
<b>WARNING</b> .....	<b>7</b>	<b>DESCRIPTIONS OF ADDITIONAL FEATURES</b>	
<b>MODEL DESCRIPTION</b> .....	<b>11</b>	(AVAILABLE WITH THE PREMIUM DISPLAY) ..	42
GENERAL .....	11	LCD Screen .....	42
OPERATOR PROTECTION EQUIPMENT .....	12	Operator Passwords .....	43
NAMEPLATE .....	14	Daily Check List and Service Items .....	43
SAFETY LABELS .....	14	Performance Modes .....	43
INSTRUMENTS AND CONTROLS .....	19	Status Code Lists .....	44
OPERATOR CONTROLS - JOYSTICK		<b>NORMAL SEQUENCE OF OPERATION -</b>	
FEATURES .....	36	STANDARD DISPLAY PANEL .....	44
<b>DISPLAY PANEL FEATURES</b> .....	<b>39</b>	<b>NORMAL SEQUENCE OF OPERATION -</b>	
PREMIUM DISPLAY PANEL .....	39	PREMIUM DISPLAY PANEL .....	45
DISPLAY PANEL FEATURES .....	39	<b>OPERATING PROCEDURES</b> .....	<b>53</b>
DESCRIPTIONS OF COMMON FEATURES .....	41	GENERAL .....	53
LED Symbol Indicators .....	41	Know Your Lift Truck .....	53
LCD Screen .....	41	Stability And Center Of Gravity .....	53
Battery Discharge Indicator (BDI) .....	41	Capacity (Weight And Load Center) .....	55

INSPECTION BEFORE OPERATION .....	55	<b>MAINTENANCE .....</b>	<b>81</b>
Checks With The Key Switch OFF .....	55	GENERAL .....	81
Mounting and Dismounting .....	56	SERIAL NUMBER DATA .....	82
How To Check The SRO Circuit .....	56	HOW TO MOVE A DISABLED LIFT TRUCK ....	82
Checks With The Key Switch ON .....	57	How To Tow The Lift Truck .....	83
OPERATING TECHNIQUES .....	59	HOW TO PUT A LIFT TRUCK ON BLOCKS ....	83
Basic Operating Procedures .....	59	How To Raise The Drive Tires .....	83
Driving And Direction Changes .....	62	How To Raise The Steering Tires .....	84
Steering (Turning) .....	63	<b>MAINTENANCE PROCEDURES EVERY 8 HOURS</b>	
Load Handling, General .....	64	<b>OR DAILY .....</b>	<b>100</b>
Load Handling, Lifting, Lowering And		HOW TO MAKE CHECKS WITH THE KEY	
Tilting .....	65	SWITCH OFF .....	100
Load Handling, How To Engage And Disengage		Tires And Wheels .....	100
A Load .....	68	Forks .....	102
Load Handling, Travelling .....	71	Forks, Adjustment .....	102
Load Handling, Emergency Load Lowering ...	75	Forks, Removal .....	102
HIGHWAY TRUCK, RAILROAD CARS AND		Fork Installation .....	104
DOCKS .....	77	Inspection of Forks, Mast And Lift Chains ....	104
ATTACHMENTS .....	78	Safety Labels .....	105
STOPPING .....	79	Steering Column Latch .....	106
PARKING .....	79	Operator Restraint System .....	106
		Automatic Locking Retractor (ALR) .....	107

Emergency Locking Retractor (ELR) .....	107	Change The Battery, ERC030-040AH And ERC040-065GH Lift Trucks .....	124
Battery Restraint System, ERP040-060DH Lift Trucks .....	109	<b>WHEELS AND TIRES</b> .....	<b>128</b>
Battery Restraint System, ERC030-040AH and ERC040-065GH Lift Trucks .....	110	SOLID RUBBER TIRES .....	128
Battery .....	113	Remove The Wheels From The Lift Truck ....	129
Hydraulic System .....	114	Remove And Install The Tire On The Wheel .....	129
<b>HOW TO MAKE CHECKS WITH THE KEY SWITCH ON</b> .....	116	SOLID RUBBER TIRE, DISASSEMBLE .....	130
Horn, Lights And Alarm .....	116	SOLID RUBBER TIRE, ASSEMBLE .....	130
Steering System .....	117	PNEUMATIC TIRES AND WHEELS .....	133
Service Brakes .....	117	Remove The Wheels From The Lift Truck ....	133
Parking Brake .....	117	PNEUMATIC TIRES AND WHEELS, DISASSEMBLE .....	134
Control Levers And Pedals .....	118	Remove The Wheel From The Pneumatic Tire .....	134
Lift System Operation .....	118	PNEUMATIC TIRES AND WHEELS, ASSEMBLE .....	137
Oil Leaks .....	119	Install The Wheel In The Pneumatic Tire ....	137
<b>HOW TO CHARGE THE BATTERY</b> .....	119	Add Air To The Tires .....	140
<b>HOW TO CHANGE BATTERIES</b> .....	122	Install The Wheels .....	141
General .....	122		
Change The Battery, ERP040-060DH Lift Trucks .....	122		

SOLID RUBBER TIRES ON PNEUMATIC WHEELS .....	142	HOW TO MOVE A LIFT TRUCK ON A TRANSPORT .....	148
Remove The Wheels From The Lift Truck ....	142	Loading .....	149
SOLID RUBBER TIRES ON PNEUMATIC WHEELS, DISASSEMBLE .....	142	Unloading .....	150
Remove The Solid Rubber Tire From The Pneumatic Wheel .....	142	PREPARATION FOR USE .....	150
SOLID RUBBER TIRES ON PNEUMATIC WHEELS, ASSEMBLE .....	144	Preparation After Transport .....	150
Install The Solid Rubber Tire On The Pneumatic Wheel .....	144	CHANGES TO THE OVERHEAD GUARD .....	150
Install The Wheels .....	146	BATTERY SPECIFICATIONS, ERP040-060DH .....	151
HOW TO PUT AN ELECTRIC SIT DOWN RIDER TRUCK IN STORAGE .....	146	BATTERY SPECIFICATIONS, ERC030-040AH .....	152
HOW TO PUT BATTERIES IN STORAGE .....	147	BATTERY HEIGHT SPECIFICATIONS, ERC030-040AH .....	153
HOW TO PUT A LIFT TRUCK BACK INTO SERVICE .....	148	BATTERY SPECIFICATIONS, ERC040-065GH .....	154
		BATTERY SPECIFICATIONS, ERC040-065GH .....	155



The following **WARNING** is a label and must be on the lift truck.

**⚠ WARNING**

**FAILURE TO FOLLOW THESE INSTRUCTIONS CAN CAUSE SERIOUS INJURY OR DEATH.**

**AUTHORIZED, TRAINED OPERATOR ONLY.**

**KNOW THE EQUIPMENT:** KNOW operating, inspection and maintenance instructions in MANUAL. DO NOT operate or repair truck unless trained and authorized. INSPECT truck before use. Do not operate if truck needs repair. Tag truck and remove key. Repair truck before use. USE attachments for intended purpose only. MAKE SURE truck is equipped with overhead guard and load backrest adequate for the load.

**LOOK WHERE YOU ARE GOING:** IF YOU CAN'T SEE, DON'T GO. TRAVEL in reverse if load blocks forward vision. MAKE SURE tailswing area is clear before turning. SOUND horn at intersections or whenever vision is blocked. WATCH clearances, especially overhead.

**KNOW YOUR LOADS:** Handle only stable loads within specified weight and load center. See plate on this truck. DO NOT handle loose loads higher than load backrest. SPACE forks as far apart as load allows and center load between forks. Keep load against load backrest.

**KNOW THE AREA:** CHECK dockboard width, capacity and security. NEVER enter a trailer or railroad car unless its wheels are blocked. WATCH floor strength. FILL fuel tank or charge battery only in designated area. AVOID sparks or

open flame. Provide ventilation. TURN OFF engine when fueling. DO NOT start truck if fuel is leaking. KEEP vent caps clear when charging battery. DISCONNECT battery during servicing.

**USE COMMON SENSE:** NEVER transport people on any part of the truck. DO NOT use truck to lift people unless there is no other practical option. Then use only a securely attached special work platform. ALLOW NO ONE under or near lift mechanism or load. DO NOT move truck if anyone is between truck and stationary object. OPERATE truck only from operator's seat. KEEP arms, legs, and head inside operator's compartment. OBEY traffic rules. Yield right-of-way to pedestrians. BE in complete control at all times. BEFORE DISMOUNTING, neutralize travel control, lower carriage, set brake. WHEN PARKING, also shut off power, close LPG fuel valve, block wheels on inclines.

**PROTECT YOURSELF, FASTEN YOUR SEAT BELT:** AVOID bumps, holes, loose materials, and slippery areas. AVOID sudden movements Operate all controls smoothly. NEVER turn on, or angle across an incline. Travel slowly. TRAVEL on inclines with load uphill or unloaded with mast downhill. TILT mast slowly and smoothly. LIFT or LOWER with mast vertical or tilted slightly back. Use minimum tilt when stacking elevated loads. TRAVEL with carriage as low as possible and tilted back. SLOW DOWN before turning—especially without load. **FAILURE to follow these instructions can cause the lift truck to tip over!** DO NOT jump off if the truck tips! HOLD steering wheel firmly. BRACE your feet. LEAN FORWARD and AWAY from the point of impact.

- 1. OVERHEAD GUARD
- 2. SEAT BELT AND HIP RESTRAINT BRACKET
- 3. MAST
- 4. LOAD BACKREST EXTENSION
- 5. CARRIAGE
- 6. FORKS
- 7. DRIVE AXLE AND WHEELS
- 8. STEERING AXLE AND WHEELS
- 9. COUNTERWEIGHT

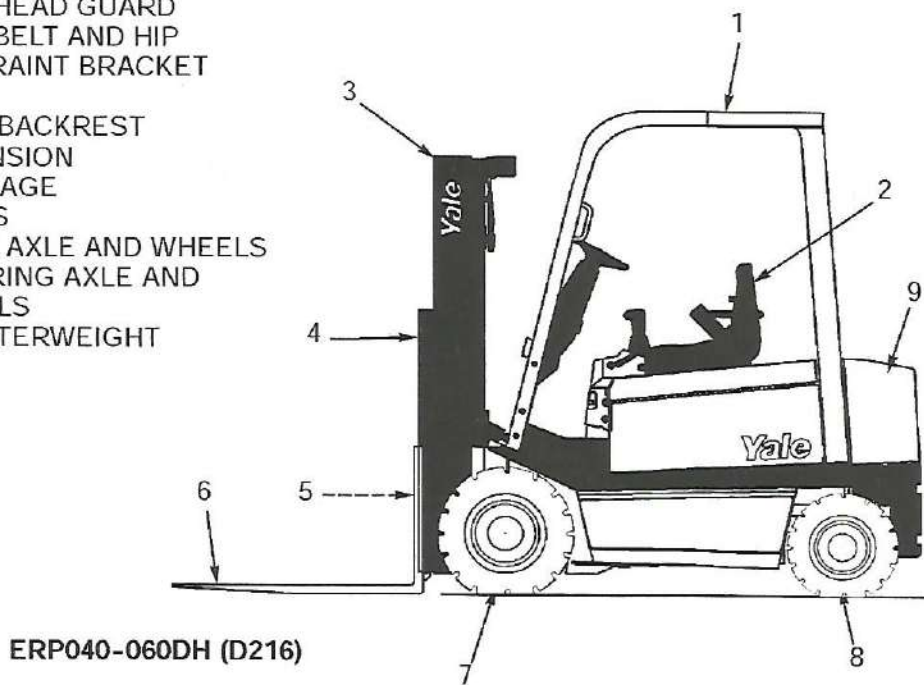

YO190029

FIGURE 1. MODEL VIEW SHOWING MAJOR COMPONENTS (1 of 3)

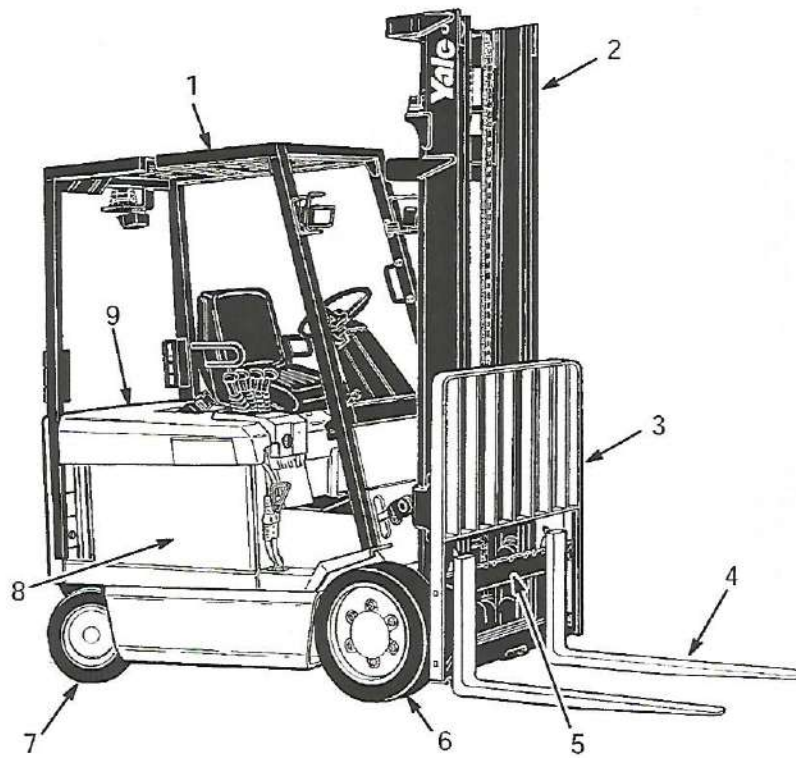

1. OVERHEAD GUARD
2. MAST
3. LOAD BACKREST EXTENSION
4. FORKS
5. CARRIAGE
6. DRIVE WHEELS
7. STEER WHEELS
8. BATTERY
9. COUNTERWEIGHT

**ERC040-065GH (A908)**

FIGURE 1. MODEL VIEW SHOWING MAJOR COMPONENTS (2 of 3)

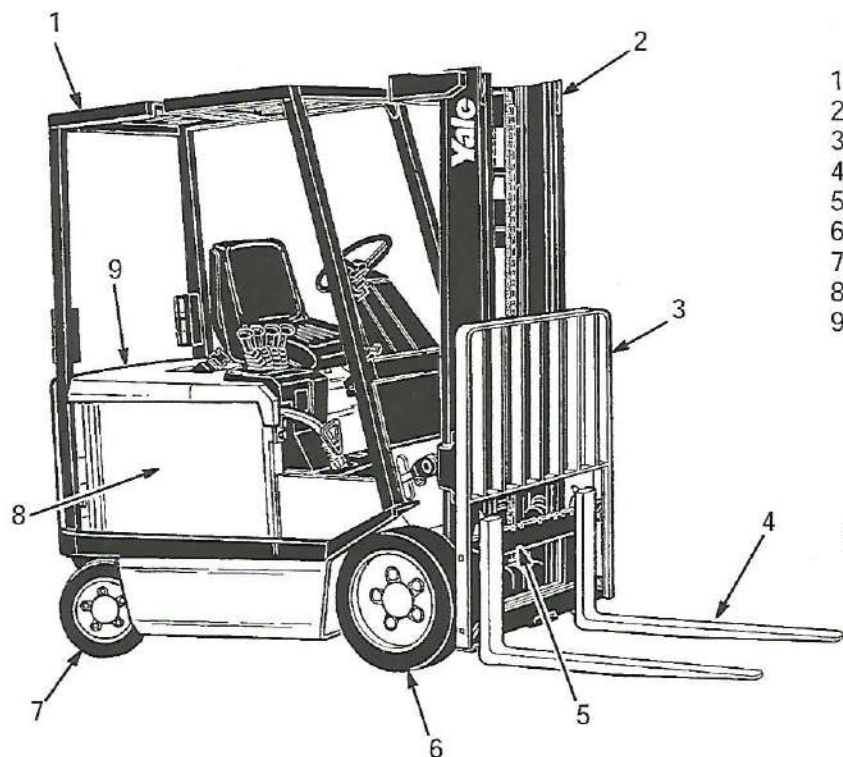

- 1. OVERHEAD GUARD
- 2. MAST
- 3. LOAD BACKREST EXTENSION
- 4. FORKS
- 5. CARRIAGE
- 6. DRIVE WHEELS
- 7. STEER WHEELS
- 8. BATTERY
- 9. COUNTERWEIGHT

ERC030-040AH (B814)

FIGURE 1. MODEL VIEW SHOWING MAJOR COMPONENTS (3 of 3)

## MODEL DESCRIPTION

## GENERAL

This series of electric rider lift trucks is available in the following models:

ERC040GH, ERC050GH, ERC060GH and ERC065GH (A908)

ERC030AH and ERC040AH (B814)

ERP040DH, ERP050DH and ERP060DH (D216)

The ERC series of lift trucks have solid rubber tires (often called cushion tires) that are pressed onto the rim.

The ERP series of lift trucks have pneumatic tires or solid rubber tires that look like pneumatic tires.

The operation of the lift truck is the same for all models. A battery supplies power for the traction motor, the hydraulic pump motor, the power steering pump motor and the control panel and instruments.

These models all use AC motor and control technology for the traction system. The hydraulic pump motor can be a DC motor controlled by a contactor, or an AC motor controlled by an AC motor controller. The steering motor is a DC brushless motor.

The electric lift trucks described in this manual have regenerative braking. This is in addition to the regular ser-

vice brakes at the drive wheels. Regenerative braking allows the operator to change the direction of travel, without applying the service brakes. When a new direction of travel is selected, regenerative braking uses the motor to stop the lift truck before traveling in new direction.

A brake pedal actuates the hydraulic service brakes at the drive wheels. A foot operated parking brake also actuates the same brakes. Some lift trucks have additional linkage that actuates a parking brake on the drive shaft of the traction motor. This extra parking brake is actuated when the operator leaves the seat.

Forward or reverse movement can be controlled by a direction control lever mounted on the steering column or by a Foot Directional Control pedal. When a direction control lever is installed, the lift truck has an accelerator pedal for speed control. If the lift truck has a Foot Directional Control pedal, the pedal controls both direction and speed.

The ERC040-065GH lift trucks can be equipped with either standard manual hydraulic levers (see FIGURE 4.) or Electro-Hydraulic (E-Hydraulic) levers which consists of either mini-levers or a joystick (see FIGURE 5.).

All lift trucks are equipped with a battery discharge indicator and an hourmeter. The bar graph type of battery discharge indicator shows the state-of-charge of the battery. The system also has a "lift interrupt" function, which prevents the operator from lifting loads, when battery power is low, and saves enough battery power for operator to move lift truck to a battery recharger. These lift trucks have a "light emitting diode" (red LED) display panel as indicators and a "liquid crystal display" (LCD) screen. The LCD screen shows the battery bar graph and gives other service information. Hourmeter operating time(s) are shown on the (LCD) screen.

### **OPERATOR PROTECTION EQUIPMENT**

The OVERHEAD GUARD (see FIGURE 1.) is intended to offer reasonable protection to the operator from falling objects, but cannot protect against every possible impact. Therefore, it must not be considered a substitute for good judgment and care when handling loads. Do not remove the overhead guard.

The BATTERY RESTRAINT is designed to hold the battery within the battery compartment if a tipover occurs. The ERP040-060DH series of lift trucks have a restraint rod fastened to the bulkhead of the battery compartment. The assembly for the hydraulic control levers holds the

hood in the closed position. The hood can be raised for battery access. Gas springs help raise and hold the hood in the up position. A lever fastened to the restraint rod will retract the restraint rod for battery removal and prevent closing the hood if the restraint rod is not correctly engaged.

The ERC030-040AH and ERC040-ERC065GH series lift trucks have a steel plate (hood frame) under the hood that is connected to the truck frame with hinges. A gas spring helps raise the hood. A stop rod holds the hood in the up position. A latch locks the hood assembly in the down position.

The battery restraint system must function so that the operator restraint system can operate correctly. Operation of the battery restraint system requires that the maximum movement allowed for the battery is 13 mm (0.5 in.) in any horizontal direction. This will reduce the risk of operator injury in a truck tipover. An adjustable battery spacer plate prevents the front-to-back movement of the battery. Batteries for this series of lift trucks must all have the same length dimension to just fit the battery compartment width. For correct battery sizes, see the BATTERY SPECIFICATIONS at the rear of this manual.

The SEAT BELT and HIP RESTRAINT BRACKETS provide additional means to help the operator keep the head and torso substantially within the confines of the truck frame and operator compartment if a tipover occurs. This restraint system is intended to reduce the risk of the head and torso being trapped between the lift truck and the ground, but it can not protect the operator against all possible injury in a tipover. The hip restraint bracket will help the operator resist side movement if the seat belt is not fastened. It is not a substitute for the seat belt. Always fasten the seat belt.

The LOAD BACKREST EXTENSION is installed to keep loose parts of the load from falling back toward the operator. It must be high enough, with openings small enough to prevent the parts of the load from falling backwards. If

a load backrest extension that is different from the one installed on your truck is required, contact your dealer for YALE lift trucks.



**NAMEPLATE**



**NOTICE LABEL**

FIGURE 2. NAMEPLATE AND LABEL

## NAMEPLATE

### WARNING

**Any change to the lift truck, the tires or its equipment can change the lifting capacity. If the Nameplate does not show the maximum capacity, or if the lift truck equipment, including the battery for electric trucks, does not match that shown on the Nameplate, the lift truck must not be operated.**

The capacity is specified in kilograms (kg) and pounds (lb). The capacity is the maximum load that the lift truck can handle for the load condition shown on the Nameplate.

The maximum capacity for the lift truck, at full load height, must be shown on the Nameplate. Special capacities with the load height reduced or with optional load centers, may also be shown on the Nameplate.

The lift truck serial number code is on the Nameplate. The serial number code is also stamped on the right side of the rear bulkhead (battery compartment) on the top edge or on the front face near the top.

When a lift truck is shipped incomplete from the factory, the Nameplate is covered by the label shown in FIGURE 2. If your lift truck has this type of label, do not operate the lift truck. Contact your dealer for YALE lift trucks to obtain a complete Nameplate.

## SAFETY LABELS

Safety labels are installed on the lift truck to give information about possible hazards. It is important that all safety labels are installed on the lift truck and can be read. See FIGURE 3.



**WARNING**  
FAILURE to follow these instructions can cause SERIOUS INJURY or DEATH!  
AUTHORIZED TRAINED OPERATOR ONLY!

**KNOW THE EQUIPMENT:**  
• KNOW operating, inspection and maintenance instructions, and warnings in MANUAL.  
• DO NOT operate or repair truck unless trained and authorized.  
• INSPECT truck before use. Do not operate if truck needs repair. Tag truck and remove keys. Repair truck before use.  
• USE attachments for intended purpose only.  
• MAKE SURE truck is equipped with overhead guard and load restraint attachment for the load.

**LOCK WHERE YOU ARE GOING:**  
• IN YOUR DRAFT SILE, DON'T GO!  
• TRAVEL in reverse if load blocks forward vision.  
• MAKE SURE backing area is clear before turning.  
• SIGNAL horn at intersections or whenever vision is blocked.  
• WAITY! (caution, especially overhead).

**KNOW YOUR LOADS:**  
• Handle only rated loads with assigned weight and load center. See plate on the truck.  
• DO NOT handle loads higher than load indicator.  
• SPACE forks on to equal at least above and center load between forks. Keep load against load indicator.

**KNOW THE AREA:**  
• CHECK authorized walk, standby and safety.  
• NEVER enter a trailer or railroad car unless it is properly secured.  
• WATCH floor strength.  
• FILL fuel tank or charge battery only in designated area.  
• AVOID spills or open flames. Provide ventilation.  
• TURN OFF engine when fueling.  
• DO NOT start truck if fuel is leaking.  
• KEEP feet cool when charging battery.  
• DISCONNECT battery during servicing.

**USE COMMON SENSE:**  
• NEVER transport people on any part of the truck.  
• DO NOT use truck to lift people unless it is an approved practice option. Then use only a specially attached special work platform. Follow instructions in manual.  
• AVOID ANY DMF unless it is used in accordance with instructions.  
• DO NOT move truck if anyone is between truck and stationary object.  
• OPERATE truck only from operator's seat.  
• OPERATE truck only from operator's seat.  
• KEEP arms, legs, and head inside operator's compartment.  
• OBEY traffic rules. Yield right-of-way to pedestrians.  
• DO in complete control at all times.  
• BEFORE DISMOUNTING, make sure lower carriage, set brake.  
• WHEN PARKING, also shut off power, chock 1/2 full valve, block wheels on incline.

**PROTECT YOURSELF:**  
• AVOID jumps, holes, loose materials, and slippery areas.  
• AVOID sudden movements. Control all carriage movements.  
• NEVER take on or angle across an incline. Travel slowly.  
• TRAVEL on incline with load uphill or unladen with mast lowered.  
• TILT mast slowly and smoothly. UP or DOWN with mast raised or tilted slightly back. Use strain relief when carrying elevated load.  
• TRAVEL with carriage as low as possible and travel back.  
• SLOW DOWN before turning, especially without mast.  
• FAILURE to follow these instructions can cause the truck to tip over!  
• DO NOT JUMP off of the truck load HELD against wheel flange.  
• BRACE your seat, LEAN FORWARD and AWAY from point of impact.

**WARNING**

**Fasten Seatbelt**

Truck can TIP OVER!  
Risk of serious INJURY or DEATH!

If Truck Tips Over  
Do Not Jump!

Lean Forward  
Hold On Tight  
Brace Feet  
Lean Away From Impact

**WARNING**

**WARNING**

**BATTERY SPACERS MUST BE PROPERLY ADJUSTED TO LIMIT BATTERY MOVEMENT**

For correct operation of the battery restraint during a TRUCK TIpOVER, the battery spacers must be properly adjusted to limit battery movement to no more than 13 mm (0.5 in). See the OPERATING MANUAL for adjustment procedures.

**WARNING** Yale Lift Truck Model

Serial Number: \_\_\_\_\_ Sales Code: \_\_\_\_\_

Trained Operators and Mechanics only

Read Operating Manual located on or near seat

Failure to follow operating instructions and maintenance instructions can cause serious injury or death.

CAPACITY WITH MAST REEST CALLED EQUIPPED AS SHOWN

Capacity	Load Height		Load Center	
	Dist. A	Dist. B	Dist. C	Dist. D
kg	mm	mm	mm	mm
lb	in	in	in	in

**WARNING**

**Yale**

**OPERATING MANUAL**

ERP040-060DH(D216)

DO NOT REMOVE THIS MANUAL FROM THIS UNIT

YALE CORPORATION PART NO. M307-100-10001 YD156037

**WARNING**

**MOVING MAST—CRUSH POINTS!**

Keep Hands Clear of Mast!

**WARNING**

REFER TO PARTS MANUAL FOR PART NUMBER AND LOCATION  
FIGURE 3. WARNING AND SAFETY LABELS (1 of 2)

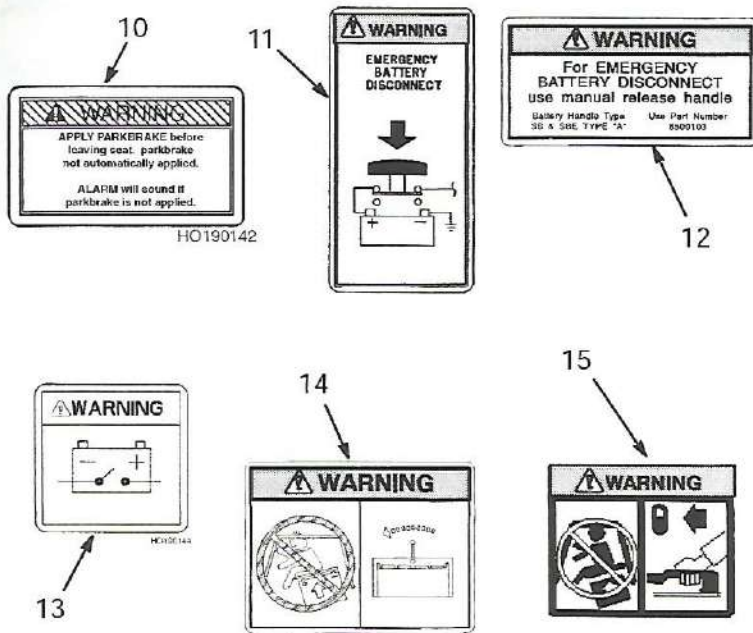

1. WARNING LABEL - OPERATION
2. TIPOVER WARNING LABEL
3. NO ONE ON OR UNDER THE FORKS
4. BATTERY SPACER WARNING
5. NAMEPLATE
6. NO RIDERS
7. CASE WITH OPERATING MANUAL
8. PINCH POINT (MAST)
9. PINCH POINT (COWL & SEAT)
10. APPLY PARKING BRAKE WARNING (WITHOUT SEAT BRAKE)
11. EMERGENCY DISCONNECT (ERP040-060DH TRUCKS)
12. EMERGENCY DISCONNECT (ERC030-040AH AND ERC040-ERC065GH TRUCKS)
13. BATTERY DISCONNECT
14. BATTERY RESTRAINT WARNING (ERP040-060DH TRUCKS)
15. BATTERY RESTRAINT WARNING (ERC030-040AH AND ERC040-ERC065GH TRUCKS)

REFER TO PARTS MANUAL FOR PART NUMBER AND LOCATION  
 FIGURE 3. WARNING AND SAFETY LABELS (2 of 2)

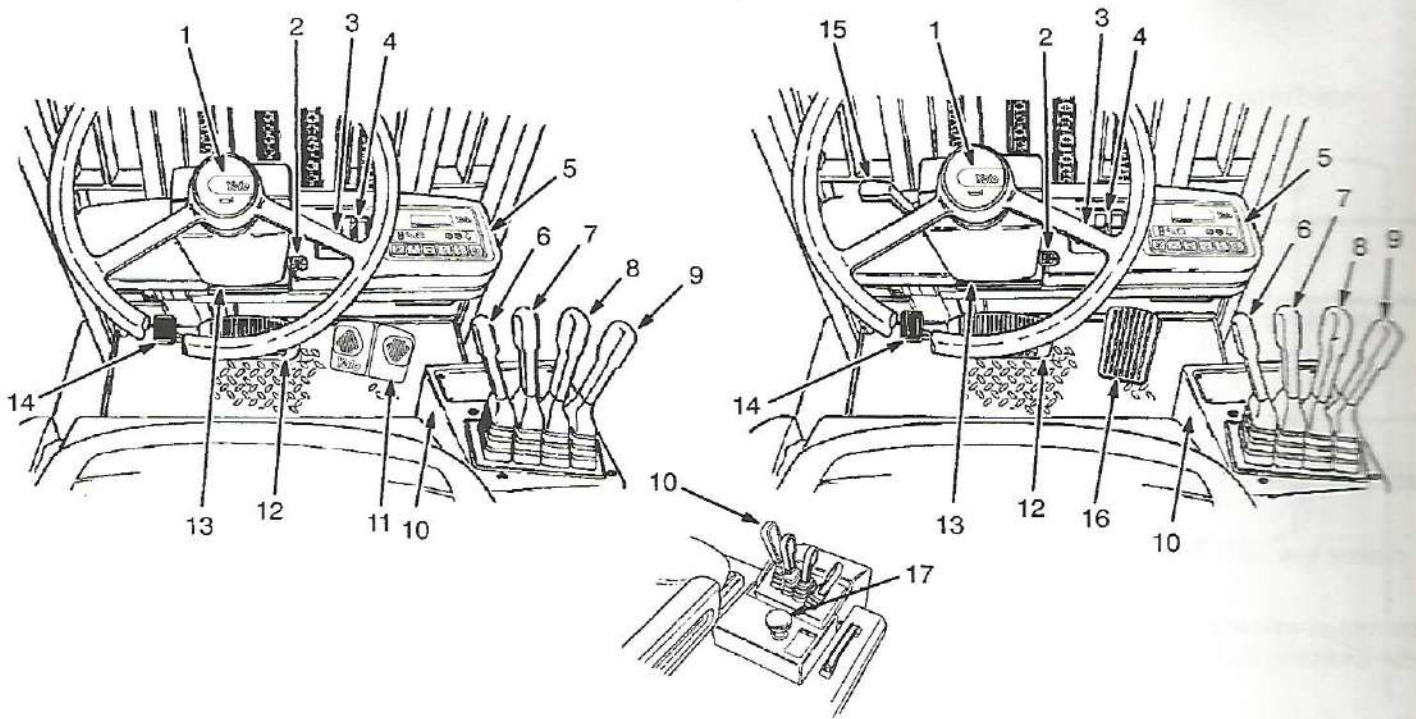

FIGURE 4. INSTRUMENTS AND CONTROLS

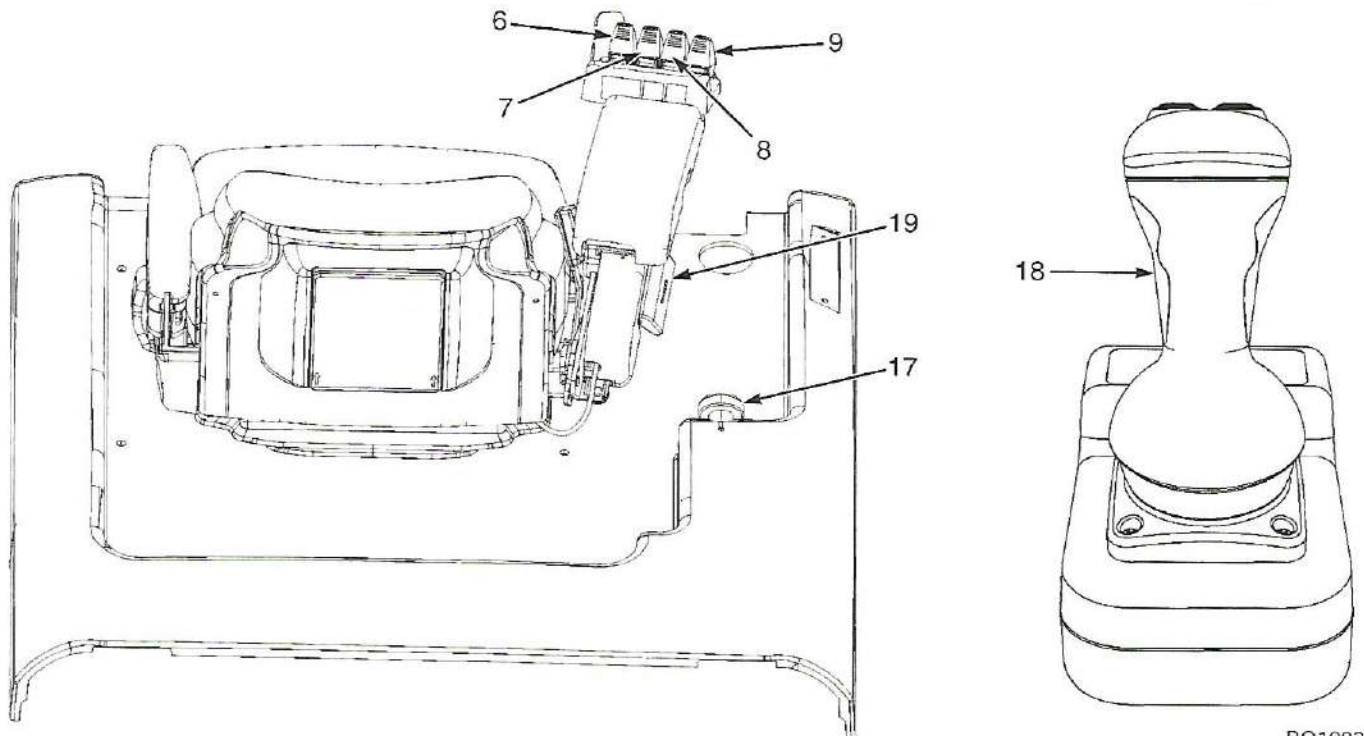

FIGURE 5. INSTRUMENTS AND CONTROLS - ELECTRO-HYDRAULIC CONTROLS  
ERC040-065GH LIFT TRUCKS ONLY

BO190206

**INSTRUMENTS AND CONTROLS**



**⚠ WARNING**

If any of the instruments, levers, or pedals do not operate as described in the following tables, report the problem immediately. **DO NOT** operate the lift truck until the problem is corrected.

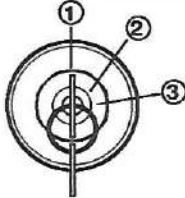
**TABLE 1. INSTRUMENTS AND CONTROLS (See FIGURE 4. AND FIGURE 5.)**

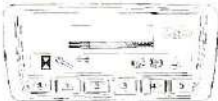
ITEM NO.	ITEM	FUNCTION
1	Horn Button 	Push the horn button to warn pedestrians and others when approaching intersections and other blind areas.
2	Key Switch 	The key switch has three positions: No. 1 Position: <b>OFF</b> position. Deenergizes all electric circuits except for the horn. No. 2 Position: <b>ON</b> position. Energizes all electric circuits. The key switch will be in this position during normal operation. No. 3 Position: <b>START</b> position. NOT USED. However, if the key is moved to this position, a spring returns the key to position No. 2 ( <b>ON</b> position) when the key is released. <b>NOTE:</b> There is a mechanical lockout that prevents the key switch from being returned to the <b>START</b> position without first being returned to the <b>OFF</b> position.

ITEM NO.	ITEM	FUNCTION
3	Steering Wheel	The steering wheel controls the movement of the steer wheels. Rotate the steering wheel clockwise for a right turn and counterclockwise for a left turn.
4	Light Switches <b>1 2 3</b> 	There is a rocker switch for each of the following light functions: (1) Front Driving/Brake/Reverse/Parking lights, (2) Rear Driving light and the Strobe light or sometimes Strobe light only (3) Operator Compartment light or sometimes Strobe light only. All of these lights are not on every unit.
5	Standard or Premium Display Panel  YO190032	<p><b>NOTE:</b> Both the Standard and Premium display panels look the same. The difference is in the software programs used by each display panel. A description of these functions is found in the section DISPLAY PANEL FEATURES in this manual.</p> <p>See DISPLAY PANEL FEATURES of this section, and FIGURE 7., TABLE 3., and TABLE 4. for information on the Standard and Premium Display Panels.</p>

ITEM NO.	ITEM	FUNCTION
6	Lift/Lower Control Lever 	<p><b>NOTE:</b> On lift truck models ERC040-065GH, manual hydraulic control levers are standard (see FIGURE 4.). Two optional E-Hydraulic controls are available for the hydraulic functions: electronic hydraulic mini-levers (see FIGURE 5.) or a joystick (see FIGURE 6. and TABLE 2.).</p> <p><b>NOTE:</b> On lift truck models ERC040-065GH, to operate the mini-levers, the operator must be on the seat and the arm rest must be in the down position.</p> <p>The lift/lower control lever can be either the first manual lever or first mini-lever to the right of the operator's seat. Pull backward towards operator to raise the carriage and forks. Push forward to lower the carriage and forks.</p>
7	Tilt Control Lever 	<p><b>NOTE:</b> On lift truck models ERC040-065GH, manual hydraulic control levers are standard. (see FIGURE 4.). Two optional E-Hydraulic controls are available for the hydraulic functions: electronic hydraulic mini-levers (see FIGURE 5.) or a joystick (see FIGURE 6. and TABLE 2.).</p> <p><b>NOTE:</b> On lift truck models ERC040-065GH, to operate the mini-levers, the operator must be positioned in the seat and the arm rest must be in the down position.</p> <p>The tilt control lever can be either the second manual lever or second mini-lever to the right of the operator's seat. Push the lever forward to tilt the mast and forks forward. Pull the lever backward toward operator to tilt the mast and forks backward.</p>

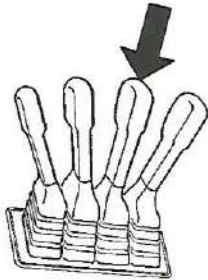

ITEM NO.	ITEM	FUNCTION
8	<p>Manual Control Lever for Auxiliary Hydraulic Functions (3rd Lever)</p> 	<p><b>⚠ WARNING</b>  <b>A manual control lever with a detent must be installed when an attachment with a clamp is installed. See your dealer for Yale lift trucks to get the correct control lever.</b></p> <p><b>NOTE:</b> On Lift truck models ERC040-065GH, manual hydraulic control levers are standard. (see FIGURE 4.). Two optional E-Hydraulic controls are available for the hydraulic functions: electronic hydraulic mini-levers (see FIGURE 5.) or a joystick (see FIGURE 6. and TABLE 2.).                      The third manual control lever is installed to the right of the manual tilt control lever. This lever can have two methods of operation, depending on the attachment.</p> <p><b>NOTE:</b> if truck is equipped with only three levers and clamp attachment, the last (3rd) lever controls clamp functions.</p> <p><b>Control Lever with a Detent - Attachments with a clamp action:</b> The lever is spring-loaded toward the operator. The lever is operated by moving it to the right, then forward and back.</p> <p><b>Control Lever without a Detent - Attachments without a clamp action:</b> The lever is operated by moving it forward and back.</p>

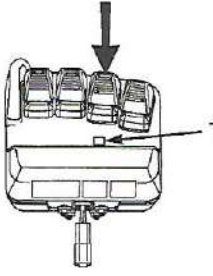



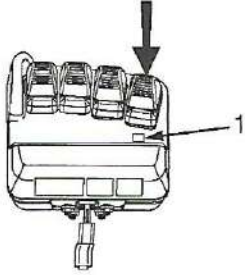
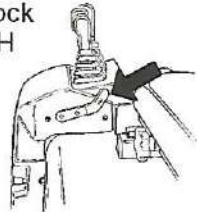

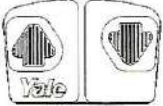
ITEM NO.	ITEM	FUNCTION
8	<p>Electronic Control Mini-Lever for Auxiliary Hydraulic Functions (3<sup>rd</sup> lever) ERC040-065GH Trucks Only</p>  <p>1. OVERRIDE BUTTON</p>	<p>The third electronic control mini-lever (see FIGURE 5.) is installed to the right of the electronic tilt control lever. This lever can have two methods of operation, depending on the attachment.</p> <p><b>NOTE:</b> To operate the mini-levers, the operator must be on the seat and the arm rest must be in the down position.</p> <p><b>NOTE:</b> If truck is equipped with only three levers and clamp attachment, the last (3rd) lever controls clamp functions.</p> <p><b>Trucks with Clamp Attachment:</b> To engage the clamp, move the mini lever backward. To disengage the clamp, press the override button located directly behind the mini lever and push the mini lever forward.</p> <p><b>Trucks without Clamp Attachment:</b> The lever is operated by moving it forward and back. The lever is spring loaded to return to the neutral position when released.</p>

ITEM NO.	ITEM	FUNCTION
9	<p>Manual Control Lever for Auxiliary Hydraulic Functions (4<sup>th</sup> lever)</p> 	<p><b>NOTE:</b> On lift truck models ERC040-065GH only, manual hydraulic control levers are standard. (see FIGURE 4.). Two optional E-Hydraulic controls are available for the hydraulic functions: electronic hydraulic mini-levers (see FIGURE 5.) or a joystick (see FIGURE 6. and TABLE 2.).</p> <p>The fourth manual control lever is installed to the right of the third manual control lever. This lever can have two methods of operation, depending on the attachment.</p> <p><b>NOTE:</b> If truck is equipped with four levers and clamp attachment, the last (4th) lever controls clamp functions.</p> <p><b>Control Lever with a Detent - Attachments with a clamp action:</b> The lever is spring-loaded toward the operator. The lever is operated by moving it to the right, then forward and back.</p> <p><b>Control Lever without a Detent - Attachments without a clamp action:</b> The lever is operated by moving it forward and back.</p>

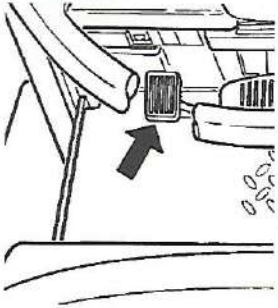
ITEM NO.	ITEM	FUNCTION
9	<p>Electronic Control Mini-Lever for Auxiliary Hydraulic Functions (4<sup>th</sup> lever) ERC040-065GH Trucks Only</p>  <p>1. OVERRIDE BUTTON</p>	<p>The fourth electronic control lever (see FIGURE 5.) is installed to the right of the third electronic control lever. This lever can have two methods of operation, depending on the attachment.</p> <p><b>NOTE:</b> To operate the mini-levers, the operator must be on the seat and the arm rest must be in the down position.</p> <p><b>NOTE:</b> If truck is equipped with four levers and clamp attachment, the last (4th) lever controls clamp functions.</p> <p><b>Trucks with Clamp Attachment:</b> To engage the clamp, move the mini lever backward. To disengage the clamp, press the override button located directly behind the mini lever and push the mini lever forward.</p> <p><b>Trucks without Clamp Attachment:</b> The lever is operated by moving it forward and back. The lever is spring loaded to return to the neutral position when released.</p>
10	<p>Control Lever Lock (ERP040-060DH Only)</p> 	<p>This lock is for the adjustable hydraulic control levers. Move the lock lever counterclockwise to release the control levers to move them to the correct position. Move the lock lever clockwise to lock the control levers in position.</p>

ITEM NO.	ITEM	FUNCTION
11	Foot Directional Control Pedal 	When the lift truck is equipped with a Foot Directional Control pedal, the direction and the speed of travel is controlled by the Foot Directional Control pedal. When the right (REVERSE) side of the pedal is pushed, the lift truck will move in the reverse direction. When the left (FORWARD) side of the pedal is pushed, the lift truck will move in the forward direction. The speed of the lift truck increases when the pedal is pushed further.
12	Brake Pedal 	This pedal, controlled by the operator's foot, applies the service brakes when pushed.
13	Handle for Steering Column Adjustment	This handle permits moving the steering column so that the battery can be removed. It also permits adjustment of the angle of the steering column to five positions for operator comfort. Lift and hold the handle while moving the steering column. Release the handle when the steering column is in the correct position. Make sure the handle is latched before operating the lift truck.

ITEM NO.	ITEM	FUNCTION
14	Parking Brake Pedal 	<p><b>⚠ WARNING</b>                      Correct adjustment is necessary to provide enough braking force. Adjust the parking brake if it needs adjustment. See Parking Brake in the MAINTENANCE section.</p> <p><b>Always apply the parking brake when you leave the lift truck. Never apply parking brake while truck is moving.</b></p> <p>The truck is equipped with a pedal for operating the parking brake. The pedal is to the left of the brake pedal. Push down to apply the parking brake. Pull the release handle to the left of the steering column to release the parking brake. If the parking brake is not applied and the operator leaves the seat or turns the key to the OFF position, a warning tone will be ON for approximately 10 seconds.</p>
15	Direction Control Lever Forward  Neutral  Reverse 	<p>The direction control lever is used on some lift trucks. When the lift truck is equipped with a direction control lever, it will also have an accelerator pedal instead of a Foot Directional Control pedal. The direction control lever has three positions: <b>Forward</b>, <b>Neutral</b> and <b>Reverse</b>. Move the lever to one of the direction positions for travel.</p>

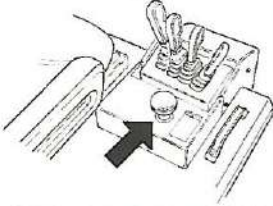
ITEM NO.	ITEM	FUNCTION
16	Accelerator Pedal 	The accelerator pedal is used with the direction control lever described in Item 15. Push down on the accelerator pedal to increase the speed of the lift truck.
17	Emergency Stop Knob (ERP040-060DH Only) 	The Emergency Stop Knob is to the rear of the hydraulic control levers on the hood. The operator can shut off all electrical power to the lift truck by pushing the knob down to operate the power disconnect circuit. To reset the Emergency Stop Knob and energize the electrical circuits, the operator must pull the knob to the <b>UP</b> position.

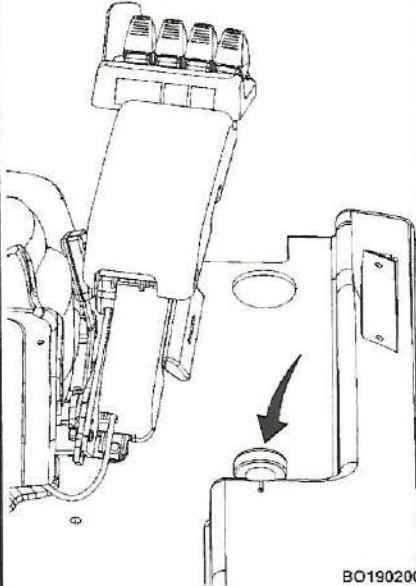
ITEM NO.	ITEM	FUNCTION
17	<p>Emergency Stop Knob (ERC040-065GH Lift Trucks With E-Hydraulic Controls)</p> 	<p>The Emergency Stop Knob is on the right side of the hood towards the rear of the seat on lift trucks equipped with E-Hydraulic control levers. The operator can shut off all electrical power to the lift truck by pushing the knob <b>IN</b> to operate the power disconnect circuit. To reset the Emergency Stop Knob and energize the electrical circuits, the operator must pull the knob <b>OUT</b>.</p>

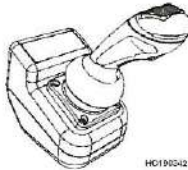
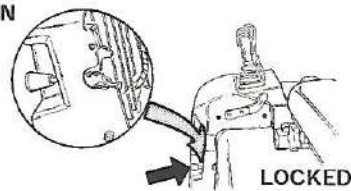
ITEM NO.	ITEM	FUNCTION
18	Joystick (ERC040-065G H Lift Trucks With E-Hydraulic Controls) 	The ERC040-065GH lift trucks in this manual can be equipped with an optional joystick to control the hydraulic functions. See FIGURE 6. and TABLE 2. for a description of the joystick features.
19	Armrest Adjustment Handle (ERC040-065GH Lift Trucks With E-Hydraulic Controls)	Pull the adjustment handle up and slide the armrest forward or backward to adjust the position of the armrest and E-Hydraulic controls. Push the adjustment handle down to lock armrest and E-Hydraulic controls into position. See FIGURE 5.
	Hood Latch (ERP040-060DH Trucks Only) (Not Shown In FIGURE 4.) OPEN  LOCKED	The lever near the driver's right knee controls the latch for the control lever assembly. Pull up on lever to release the latch and move the control lever assembly forward to permit the hood to raise. Move the steering wheel to the forward position and use the handle on the hood to raise the hood. Before lowering the hood, make sure the battery restraint rod is over the battery and the handle is down. Lower the hood, hold it down and move the control lever assembly over the hood to the latched position (one click).

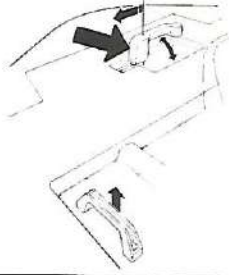

ITEM NO.	ITEM	FUNCTION
	<p>Hood Latch (ERC030-040AH And ERC040-ERC065GH Only) (Not Shown In FIGURE 4.)</p> 	<p><b>⚠ WARNING</b>  <b>Make sure the hood/battery restraint is correctly fastened. If not fastened, the battery can come out of the battery compartment during a tipover and cause an injury.</b></p> <p>The handle at the rear of the hood releases the hood frame and battery restraint. To release the latch for the battery restraint and hood, raise the latch handle, slide toward the right side of the truck. A spring moves the handle back to the left. Use the lift handle by the seat to raise the hood. A gas spring and stop rod hold the assembly in the up position. Move the latch handle to the right, release the stop rod, lower the hood completely and move the handle back to the left. Try to lift the hood to make sure the hood is fastened correctly.</p>

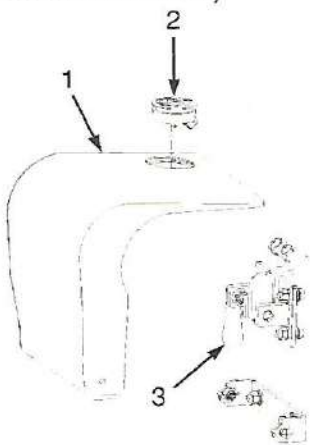
ITEM NO.	ITEM	FUNCTION
	<p>Hood Latch (ERC040-065GH Lift Trucks With E-Hydraulic Controls) (Not Shown In FIGURE 5.)</p>  <p>1. COVER 2. LATCH 3. HOOD RELEASE HANDLE</p>	<p><b>NOTE:</b> Before raising the hood, move the steering column to the forward position and slide the seat all the way back, and if necessary, move the arm-rest all the way back. (see FIGURE 5.)</p> <p>The latch that secures the cover for the hood release handle can be either a locking or non locking latch. If the latch is a locking latch, unlock latch with key first. The cover, latch and hood release handle are located on the right side of the hood.</p> <p>Pull the latch handle, located on the top of the latch, to the up position and then pull on latch handle to move cover away from hood release handle. Pull hood release handle up to release hood latch and use handle on the hood to put hood in the raised position.</p> <p>Before lowering the hood, make sure the battery restraint rod is over the battery. Lower the hood and push hood release handle down to secure hood to frame. Move cover over hood release handle and push latch handle down to secure cover to hood. If latch is a locking latch, lock latch with key.</p>

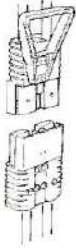
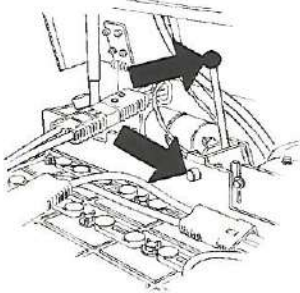
ITEM NO.	ITEM	FUNCTION
	<p>Battery Connector (Not Shown In FIGURE 4.)</p> <p>36V Grey 48V Blue 72V Green 80V Black</p> 	<p><b>⚠ CAUTION</b>  <b>Make sure both halves of the connectors are the same type and color. Make sure the voltage of the battery is the same as specified on the Nameplate. The halves of the connector must be joined for operation. Separate the halves of the connector to disconnect the battery.</b></p> <p>The battery connector is in two parts. One half of the connector is attached to the battery cables and has a handle as shown. The other half of the connector is connected to the electrical system of the lift truck.</p>
	<p>Battery Restraint (ERP040-060DH Only) (Not Shown In FIGURE 4.)</p> 	<p><b>⚠ WARNING</b>  <b>Make sure the battery restraint is correctly in the forward position and the handle is lowered. If not in the correct position, the hood will not lower and the battery can come out of the battery compartment during a tipover and cause an injury.</b></p> <p>The battery restraint is under the hood at the rear of the battery. Lift the hood and raise the handle for the battery restraint rod. Move the rod to the rear to release the battery. Move the restraint rod forward and lower the handle for correct battery restraint operation. Lower the hood and latch the control lever assembly over the hood.</p>

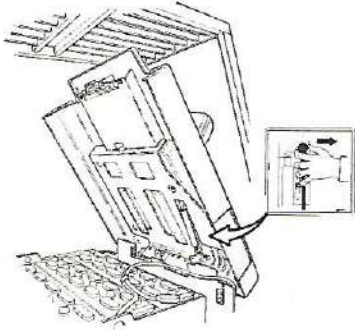
ITEM NO.	ITEM	FUNCTION
	<p>Battery Restraint (ERC030-040AH And ERC040-ERC065GH Only) (Not Shown In FIGURE 4.)</p> 	<p><b>⚠ WARNING</b>  <b>The hood and battery restraint, with its latch mechanisms, must operate correctly before the lift truck is operated.</b></p> <p>The battery restraint and hood frame is a steel weldment that has a hinge at the front of the battery compartment. Use the latch handle at the rear of the hood to release the hood frame and battery restraint. Raise the latch handle and slide the handle toward the right side of the truck. A spring moves the handle back to the left. A gas spring and stop rod will hold the assembly in the <b>UP</b> position. Release the stop rod by moving it to the right before lowering the hood.</p>

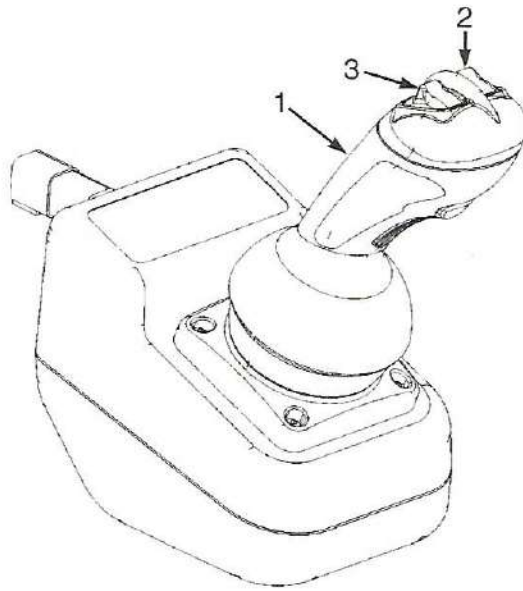

BO190234

FIGURE 6. JOYSTICK



**OPERATOR CONTROLS - JOYSTICK  
FEATURES (See TABLE 2. And FIGURE 6.)**

**⚠ WARNING**

If any of the controls, instruments, levers or pedals do not operate as described in the following tables, report the problem immediately. DO NOT operate the vehicle until the problem is corrected.

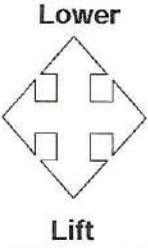
**TABLE 2. OPERATOR CONTROLS - JOYSTICK FEATURES (See FIGURE 6.)**

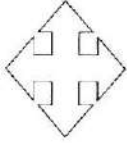
ITEM NO.	ITEM	FUNCTION
1	Lift/Lower Function  	Push the joystick lever forward to lower the carriage and forks. Pull the joystick lever rearward to raise the carriage and forks. <b>NOTE:</b> To operate the joystick, the operator must be on the seat and the arm rest must be in the down position.

ITEM NO.	ITEM	FUNCTION
1	Tilt Function 	Move the joystick lever to the left and pull back, to tilt the mast backwards. Move the joystick lever to the right and push forward, to tilt the mast forward. <b>NOTE:</b> To operate the joystick, the operator must be on the seat and the arm rest must be in the down position.
2	Auxiliary Hydraulic Function (Left Rocker Switch) 	This rocker switch can have two methods of operation, depending on the attachment. <b>NOTE:</b> To operate the joystick, the operator must be on the seat and the arm rest must be in the down position.

ITEM NO.	ITEM	FUNCTION
3	Auxiliary Hydraulic Function (Right Rocker Switch) 	This rocker switch can have two methods of operation, depending on the attachment. <b>NOTE:</b> To operate the joystick, the operator must be on the seat and the arm rest must be in the down position.



## DISPLAY PANEL FEATURES

There are two dash display options, Standard and Premium. Both displays look identical. The only difference is in the display software and the resulting functionality as described below:

### PREMIUM DISPLAY PANEL

- Allows pre-assigned user passwords to control driver access to the vehicle
- Provides 4 driving Modes that are accessed through the key pad

### DISPLAY PANEL FEATURES

The following features are common to both the Standard and Premium Display Panels: See FIGURE 7.

- LED (Light Emitting Diode) symbol indicators

- LCD (Liquid Crystal Display) screen
- Battery Discharge Indicator (BDI) (with lift interrupt when enabled)
- Service Reminder (if enabled)
- Status Codes
- STAR push button
- Hourmeter of traction and lift pump times
- Numeric push button keys
- Allow pre-assigned service passwords to control access to Service Functions available through the dash display
- Provide a set of Service Functions which are accessed through the Mode buttons and LCD screen

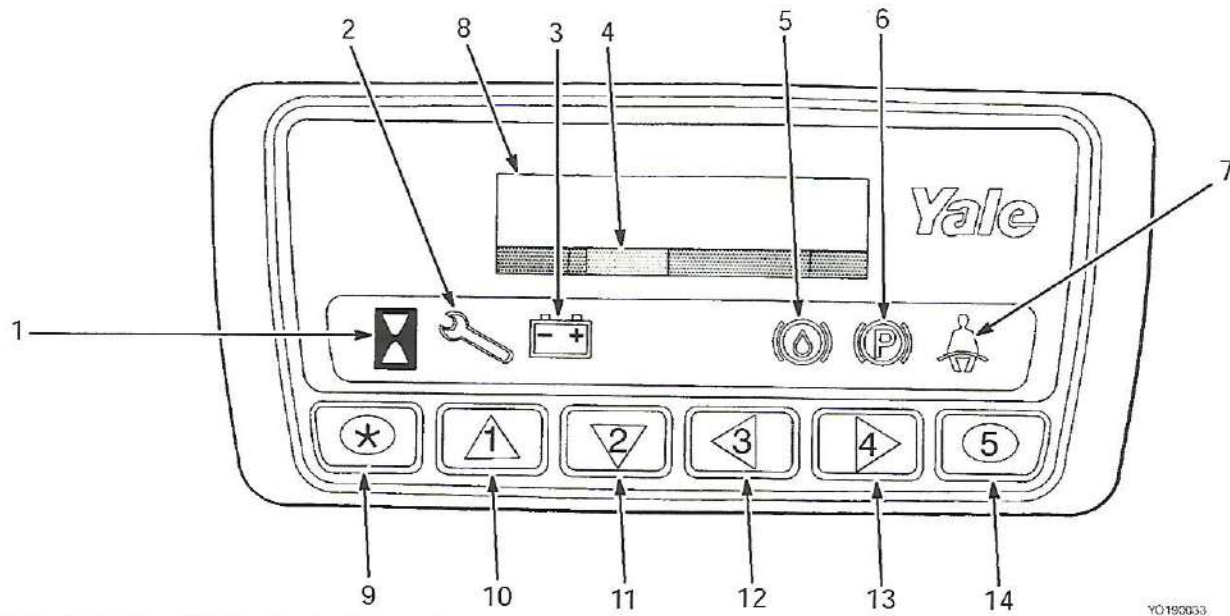

YO190033

- |                                |                            |                    |
|--------------------------------|----------------------------|--------------------|
| 1. HOURMETER INDICATOR SYMBOL  | 6. PARKING BRAKE SYMBOL    | 11. PUSH BUTTON #2 |
| 2. WRENCH INDICATOR SYMBOL     | 7. FASTEN SEAT BELT SYMBOL | 12. PUSH BUTTON #3 |
| 3. BATTERY INDICATOR SYMBOL    |                            | 13. PUSH BUTTON #4 |
| 4. BATTERY DISCHARGE INDICATOR |                            | 14. PUSH BUTTON #5 |
| 5. BRAKE FLUID SYMBOL          |                            |                    |
|                                | 9. STAR PUSH BUTTON        |                    |
|                                | 10. PUSH BUTTON #1         |                    |

FIGURE 7. FEATURES OF THE STANDARD AND PREMIUM DISPLAY PANELS

The symbol indicators are shown and described in TABLE 3.

## DESCRIPTIONS OF COMMON FEATURES

### LED Symbol Indicators

The LED symbol indicators are bright red and indicate the function that is shown on the LCD screen. Some of them are also used as a visual warning of a potential problem that needs action from the operator.

### LCD Screen

The LCD screen shows operator messages for the different functions. The display panel can show a maximum of 20 numbers or letters (including spaces) on each of two lines.

### Battery Discharge Indicator (BDI)

The Battery Discharge Indicator (BDI) uses a bar graph as a "fuel" gauge for the Battery State-of-Charge. As the battery discharges, the bar gets shorter to show less "fuel". The green band near the bar shows the normal operating range for the battery. The yellow band is the area

that the battery can still be operated in without damage. This band is yellow to indicate that the battery is nearing the point of discharge where it can be damaged with continued hard use. The red band indicates the discharge condition where battery damage can occur. Charge the battery very soon to prevent battery damage. When the battery is discharged to approximately 75%, segments 1 and 2 alternately flash on and off, and the Battery symbol flashes. Continued operation will cause lift-interrupt (if enabled) to occur to help prevent battery damage. Lift-interrupt prevents the operator from lifting loads and saves enough battery power for operator to move lift truck to a battery recharger. At lift-interrupt, there are no segments (bars) displayed, and the Battery symbol is flashing.

### Service Reminder

The Service Reminder feature (if enabled) lets the operator know when it is time for periodic maintenance. A status code of 99 will show on the LCD screen and the Wrench symbol will be flashing. If maintenance is not done within 20 more hours of operating time, lift truck performance will be reduced until maintenance is completed. Have the maintenance done by authorized maintenance personnel. The service personnel must also

set the memory for the next maintenance time to allow normal operation again.

## Status Codes

Status Codes give an indication to the operator that a possible malfunction or incorrect truck use has occurred. Status Codes are code numbers for a symptom or malfunction. The Wrench symbol will flash and the status code number will be shown on the LCD screen if an incorrect truck use or malfunction occurs during operation. Have authorized service personnel check and repair the lift truck if a status code number appears. The symptoms for each status code are shown in the service manual **AC MOTOR CONTROLLERS 2200 YRM 1056**.

## Hourmeter

The Hourmeter shows the operating time in traction hours and pump hours on the the LCD screen as a five digit number. The display is shown for four seconds after the lift truck has been operating and the key is moved to the **OFF** position. Traction hours are the time that the key has been in the **ON** position with the operator in the seat. The operating time for the hydraulic pump motor (with illuminated Hourmeter symbol) will also be displayed as a

five digit number for four seconds following the traction hours.

The word **TRACTION HOURS** will be displayed on the LCD screen when the traction motor hours are shown. The word **PUMP HOURS** will be displayed on the LCD screen when the pump motor hours are shown.

## DESCRIPTIONS OF ADDITIONAL FEATURES (AVAILABLE WITH THE PREMIUM DISPLAY)

The *additional* features of the premium display panel are described below and shown in **FIGURE 7**. Also see **TABLE 4**.

**NOTE:** In the following descriptions, words shown in all capital letters represent what is displayed on the LCD screen.

## LCD Screen

The LCD Screen shows the information for the *additional* features as follows:

- User password request (if enabled)
- Operator Check List (if enabled)

The Premium display panel can show a maximum of 20 letters or numbers (including spaces) on each of two lines.

### Operator Passwords

The Operator Passwords are a series of five numbers. Each of the five number digits can be the numbers 1 through 5. If enabled, the password number series must be entered into the memory by a technician and assigned to an operator. For security, the password numbers are not displayed when entered. Remember the password. A technician can use a personal computer (PC), connected to the vehicle, to check as well as assign the passwords.

**NOTE:** The display does not always respond immediately for every push button entry. The push button can also "click" without an actual change occurring. Make sure to watch LCD screen and wait for response before requesting another action.

After the key is moved to the **ON** position, the LCD screen will show ENTER PASSWORD, if this function is enabled. Use the numbered push buttons to enter your five digit password. A STAR symbol will be shown for each digit. The password can be entered as many times

as needed. If the password is entered incorrectly, the message PASSWORD ERROR will appear and the operator will again be prompted to ENTER PASSWORD.

### Daily Check List and Service Items

A list of items for Daily Checks And Service will be shown on the LCD screen (if enabled) after the password is accepted. The Check List has items the operator needs to check before the lift truck can be operated. Press button #1 for YES and #4 for NO after each item in Check List. These YES answers indicate that the operator says the check or maintenance has been done. The screen will show SERVICE REQUIRED for a NO answer and the lift truck will only operate in "MODE #1". This operating mode will continue until a service person performs the required service and "clears" the message. Additional Check List items will not appear until after service is complete.

### Performance Modes

Four different Performance Modes of operation can be selected. Each mode can change acceleration and top speed. The factory settings increase operating speeds from slowest 1 to fastest 4. After the message MODE #X is on the LCD screen, you can change modes. The mode

number that was last activated will appear. If you want to change the mode, push the number push button **1**, **2**, **3**, or **4** to select a new mode. The screen will show REQUESTING MODE # Y (Y is the new mode number just entered). The message will then show MODE #Y unless this mode is not permitted under your password. The lift truck will now operate within the parameters set for that mode number until you change the operating mode number again.

## Status Code Lists

The Status Code Lists is a stored history list of selected status codes for malfunctions or incorrect truck use that have occurred *since the list was last cleared of entries by a technician*. A total of 16 status codes can be stored on the list. When the 17th status code is stored onto the list, the first stored status code will be removed from the list. These selected status codes are NOT of malfunctions or symptoms that are currently present, but those that have occurred in the past. The lists can only be read with the key in the **OFF** position.

To access the status code history, wait until after the traction and pump hours have been displayed, then push

the STAR push button. All of the status codes in the list will now be shown in sequence. After the last status code, END FAULT CODE HISTORY will be shown.

## NORMAL SEQUENCE OF OPERATION - STANDARD DISPLAY PANEL

Following is the normal sequence that occurs after the operator is on the seat with the battery connected:

- After the key is moved to the **ON** position, all 40 segments of the LCD screen will be displayed as solid bars and the red indicator symbols will light up from left to right. The Seat Belt symbol will be on for an additional 10 seconds.
- The bar graph for battery-state-of charge is on LCD screen. If the battery is discharged to lift-interupt, the battery indicator symbol will also be flashing. If a battery of the wrong voltage has been installed, the Wrench light symbol will also be flashing. If necessary, have these problems corrected before attempting operation.

Turn the key to the **OFF** position. The following display sequence will occur:

- Display shows the hourmeter hours for the traction motor and the words TRACTION HOURS for four seconds.
- Display shows the hourmeter hours for the hydraulic pump motor and the words PUMP HOURS for an additional four seconds.

### NORMAL SEQUENCE OF OPERATION - PREMIUM DISPLAY PANEL

Following is the normal sequence that occurs after the operator is on the seat with the battery connected:

- After the key is moved to the **ON** position, ENTER PASSWORD will be on the LCD screen if this function is enabled.
- After password is correctly entered, or if it is disabled, the first item of the Check List will be on the LCD screen if this function is enabled.
- After Check List is complete, or if it is disabled, all 40 segments of the LCD screen will be displayed



as solid bars and the red indicator symbols will light up from left to right. Seat Belt symbol will be on for an additional 10 seconds.

- The last Performance Mode operation will be on the LCD screen as MODE #\_\_\_. The bar graph for battery-state-of charge is also on LCD screen. If the battery is discharged to lift-interrupt, the battery indicator symbol will also be flashing. If a battery of the wrong voltage has been installed, the Wrench symbol will also be flashing. If necessary, correct these problems before attempting normal operation.





Turn the key to the **OFF** position. The following display sequence will occur:

- Display shows the hourmeter hours for the traction motor and the words TRACTION HOURS for four seconds.
- Display shows the hourmeter hours for the hydraulic pump motor and the words PUMP HOURS for an additional four seconds.

TABLE 3. COMMON FEATURES (See FIGURE 7.)

ITEM NO.	ITEM	FUNCTION
1 - 3 and 5 - 7	All Indicator Symbols	<p>STANDARD DISPLAY PANEL</p> <p>When the key is moved to the <b>ON</b> position, the red indicator symbols light up from left to right and remain lit for approximately one second.</p> <p>PREMIUM DISPLAY PANEL</p> <p>When the key is moved to the <b>ON</b> position, the red indicator symbols light up from left to right and remain lit for approximately one second, after the Password function (if enabled) or Check List function (if enabled) is completed.</p>
1	Hourmeter Indicator Symbol 	The hourmeter symbol is ON when the traction or lift pump hours are shown on the LCD screen.
2	Wrench Indicator Symbol 	This red indicator is flashing when status code numbers are shown or when maintenance is due (99).
3	Battery Indicator Symbol 	This red indicator is flashing when the battery needs charging.

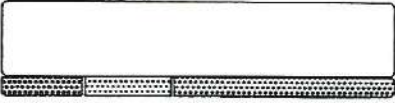

ITEM NO.	ITEM	FUNCTION
4	<p>Battery State-Of-Charge (BDI)</p>  <p>DISCHARGED TO YELLOW AREA</p> 	<p>A bar graph, representing the Battery State-of-Charge is shown on the LCD screen. See Common Features for more information.</p> <p>STANDARD DISPLAY PANEL The bar graph is on the LCD screen after the indicator function check.</p> <p>PREMIUM DISPLAY PANEL The bar graph and the message MODE #X are on the LCD screen after the LED Indicator check is complete.</p>
5	<p>Low Brake Fluid Symbol</p> 	<p>If this indicator symbol is illuminated during operation, the fluid level in the brake fluid reservoir is low and the reservoir must be filled.</p>
6	<p>Parking Brake Symbol</p> 	<p>This indicator symbol is illuminated when the parking brake is applied and the key is in the <b>ON</b> position. The indicator will go OFF when the parking brake is released.</p> <p>If the parking brake is <i>not</i> applied and the operator leaves the seat or turns the key to the <b>OFF</b> position, the symbol and a warning tone will be ON for approximately 10 seconds.</p>
7	<p>Fasten Seat Belt Symbol</p> 	<p>This indicator symbol will stay illuminated for approximately 10 seconds, after the indicator check, to remind the operator to fasten the seat belt.</p>

ITEM NO.	ITEM	FUNCTION
8	LCD "Screen" (Standard Display Panel) 	<p>The display panel, on the right side of the instrument panel (dash), has an LCD window as an operator's "screen" readout. The screen is illuminated whenever the key is in the <b>ON</b> position and for a short time after the key is first moved to the <b>OFF</b> position. Information with a maximum of 40 characters on two lines (20 characters per line) is displayed. This information includes the following: (1) traction operating time in hours, (2) lift pump operating time in hours, (3) status code numbers, (4) service reminder code 99 (if enabled) and (5) state-of-charge of the battery.</p> <p>All of the screen segments are shown as solid blocks during the indicator check to show that each segment is operating.</p>



ITEM NO.	ITEM	FUNCTION
8	Alpha Numerical "Screen" (Premium Display Panel)  	<p>This LCD screen shows the information for the common features and information for the additional features of the premium display panel. Information with a maximum of 20 characters per line in two lines can be shown. This additional information includes the following (display letters shown in all capital letters): 1) ENTER PASSWORD (if enabled), 2) Check List items (if enabled), 3) status code list (history) with number and short description. The hourmeter times are also identified as TRACTION HOURS or PUMP HOURS. MAINTENANCE REQUIRED is also included with the maintenance reminder code 99 if the function is enabled.</p> <p>All of the screen segments are shown as solid blocks during the indicator check to show that each segment is operating.</p>
9	STAR Push Button  	<p>With the key in the <b>OFF</b> position, push the STAR button once to get status code history. If password feature is enabled, turn the key to the <b>ON</b> position, push the STAR button twice and the display will ask for service password (turn key <b>OFF</b> to clear the screen).</p>

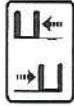
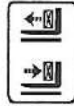





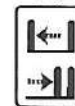

TABLE 4. ADDITIONAL FEATURES, PREMIUM DISPLAY ONLY (See FIGURE 7.)

ITEM NO.	ITEM	FUNCTION
10, 11 12, 13 and 14	Push Buttons #1 through #5 	These push buttons are used as described in DESCRIPTIONS OF ADDITIONAL FEATURES of this manual.

**TABLE 5. AUXILIARY CONTROL LEVERS**

FUNCTION The control levers will be arranged in the following order from left to right.	DIRECTION OF MOVEMENT	
	LOAD OR EQUIPMENT	CONTROL LEVER
1 REACH	Retract / Extend	Backward/Forward
2 SIDE SHIFT	Right / Left	Backward/Forward
3 PUSH - PULL	Backward / Forward	Backward/Forward
4 ROTATE	Clockwise / Counterclockwise	Backward/Forward
5 UPENDER	Up / Down	Backward/Forward
6 SCOOP	Up / Down	Backward/Forward
7 LOAD STABILIZER	Down (Clamp) / Up (Release)	Backward/Forward
8 SWING (FORKS)	Right / Left	Backward/Forward
9 SWING (CLAMP)	Right / Left	Backward/Forward
10 L.H. FORK POSITIONER	Together / Apart	Backward/Forward
11 R.H. FORK POSITIONER	Together / Apart	Backward/Forward
12 TURN FORK	Horizontal/Vertical	Backward/Forward
13 FORK SPREAD	Together / Apart	Backward/Forward
14 CLAMP	Clamp / Release	Backward/Forward

1	2	3	4	5	6	7	8	9	10	11	12	13	14
													

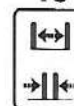
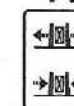
NOTES

**OPERATING PROCEDURES**

**GENERAL**

**Know Your Lift Truck**

The fork lift truck is designed to pick up and move materials. The basic lift truck has a lift mechanism and forks on the front to engage the load. The lift mechanism lifts the load so that it can be moved and stacked.

In order to understand how the fork lift truck can pick up a load, you must first know some basic things about the lift truck.

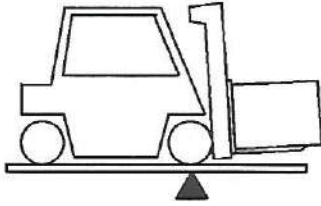

The lift truck is based on the principle of two weights balanced on opposite sides of a pivot (fulcrum). This is the same principle used for a see-saw. In order for this principle to work for a lift truck, the load on the forks must be

balanced by the weight of the lift truck. The location of the center of gravity of both the truck and the load is also a factor.

This basic principle is used for picking up a load. The ability of the lift truck to handle a load is discussed in terms of center of gravity and both forward and side stability.

**Stability And Center Of Gravity**

The center of gravity (CG) of any object is the single point about which the object is balanced in all directions.

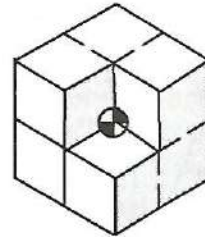

Every object has a CG. When the lift truck picks up a load, the truck and load have a new combined CG.

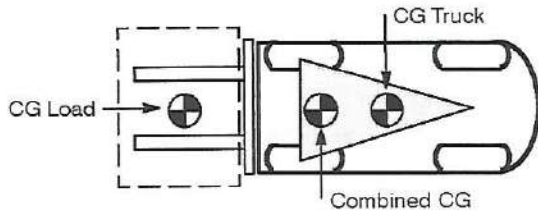

The stability of the lift truck is determined by the location of its CG, or if the truck is loaded, the combined CG.

The lift truck has moving parts and therefore has a CG that moves. The CG moves forward and back as the mast is tilted forward and back. The CG moves up and down as the mast moves up and down.

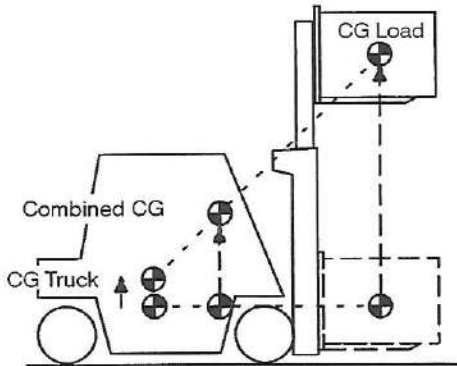

The center of gravity, and therefore the stability, of the loaded lift truck is affected by a number of factors, such as size, weight, shape, and position of the load; the height to which the load is raised; the amount of forward and backward tilt; tire pressure and the dynamic forces created when the truck is moving. These dynamic forces are caused by things like acceleration, braking, turning, and operating on uneven surfaces or on an incline. These factors must be considered when travelling with an unloaded truck, as well, because **an unloaded truck will tip over to the side easier** than a loaded truck with its load in the lowered position.

In order for the lift truck to be stable (not tip over forward or to the side) the CG must stay within the area of the lift truck represented by a triangle drawn between the drive axle and the pivot of the steering axle.

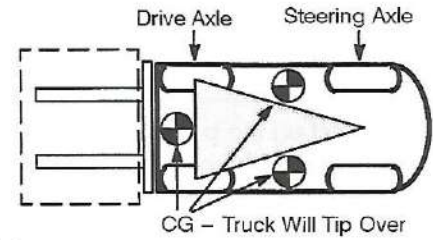



If the CG moves forward of the drive axle, the lift truck will tip forward. If the CG moves outside of the line represented by the lines drawn between the drive wheels and the steering axle pivot, the lift truck will tip to that side.

**Capacity (Weight And Load Center)**

The capacity of the lift truck is shown on the Nameplate. The capacity is listed in terms of weight and load center.

The weight is specified in kilograms and pounds. The load center is specified in millimeters and inches. The capacity is the maximum load that the lift truck can handle for the load condition shown on the Nameplate.

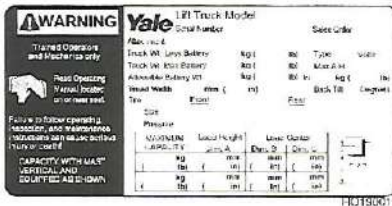

The load center of a load is determined by the location of its center of gravity. The load center is measured from the front face of the forks, or the load face of an attachment, to the center of gravity of the load. Both the vertical and horizontal load centers are specified on the Nameplate.

Loads should be transported while centered on the centerline of the lift truck. The operator must know whether or not a load is within the maximum capacity of the lift truck before the load is handled.

**INSPECTION BEFORE OPERATION**

**⚠ WARNING**

Report damage or faulty operation immediately. Do not operate a damaged or defective lift truck. A lift truck will only do its job when it is in proper working order. If repairs are required, install a tag in the operator's area stating "DO NOT OPERATE" and remove the key from the key switch.

**✓ Checks With The Key Switch OFF**

Inspect the lift truck before use and every eight hours or daily as described in the MAINTENANCE section of this OPERATING MANUAL.

Before using the lift truck, make the following checks:

- Oil level in the hydraulic tank.
- Electrolyte level and specific gravity of the battery are correct.

- Battery weight is within the range of battery weights on the Nameplate.
- Battery restraint mechanism operates correctly and is latched.
- The spacer plate is adjusted to limit forward, backward or side to side battery movement.
- Condition of forks, carriage, chains, mast and overhead guard.
- Leaks from the hydraulic system.
- Condition of wheels and tires.
- Seat belt fastens correctly.
- Seat is securely fastened to the seat plate or hood.

## Mounting and Dismounting

### **WARNING**

To avoid serious injury when entering or exiting the lift truck, **ALWAYS USE 3 POINTS OF CONTACT. Maintain contact simultaneously with two hands and one foot or with two feet and one hand while climbing on or off the lift truck.**

Place feet carefully. Always face the lift truck when climbing on or off. Use added care when surfaces are slippery. Keep hands free of any obstacles such as food, beverages, or tools.

### How To Check The SRO Circuit

**NOTE:** On ERP040-060DH trucks, pull the battery disconnect switch up, and on the ERC030-040AH and ERC040-065GH trucks, connect both halves of the battery connector, before preceding with start sequence below.

The lift truck is equipped with a "Static Return to OFF" (SRO) circuit that prevents travel of the lift truck if the starting sequence is not correct. The function of the SRO circuit is to make sure the operator is in the correct position to operate the controls before the lift truck will operate. The starting sequence:

1. Sit on the seat to close seat switch, and turn the key to the **ON** position.
2. Select the direction of travel and push the accelerator or push the Foot Directional Control pedal.

If step 2 is done before step 1 and the lift truck moves, the SRO function is not operating correctly. The sequence within step 1 is not important. The lift truck must not be operated if the SRO circuit does not function correctly. If the SRO circuit does not operate correctly, have the Master Controller checked by authorized service personnel.

When you want the lift truck to travel in the Forward or Reverse direction:

1. Make sure a charged battery of the correct voltage is installed and connected
2. Sit on the seat to close seat switch and turn key to the **ON** position.
3. Release the parking brake
4. Select the direction of travel using the Foot Directional Control pedal or the optional direction control lever

5. Push the Foot Directional Control or accelerator pedal for acceleration.



### Checks With The Key Switch ON

Do not start nor operate the lift truck, including any of its functions or attachments, from any place other than the designated operator's position.

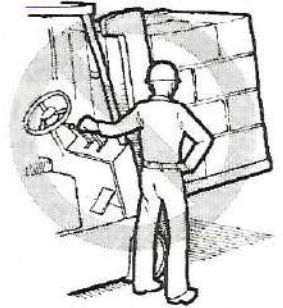

The operator must be aware that the lift truck can tip over. There is a great risk that the operator or someone else can be killed or injured if trapped or hit by the truck as it

tips over. The risk of injury can be reduced if the operator stays on the truck. If the truck tips over do not jump off.



## **WARNING**

### **FASTEN SEAT BELT** **If Lift Truck Tips Over**

- **Do Not Jump - Stay On Truck**
- **Hold Firmly To Steering Wheel - Brace Feet - Lean Forward And Away From Impact**

**The seat belt is installed to help the operator stay on the truck if the lift truck tips over. IT CAN ONLY HELP IF IT IS FASTENED.**

THE SEAT BELT AND HIP RESTRAINT BRACKET provides a means to help the operator keep the head and torso substantially within the confines of the truck frame and overhead guard if a tipover occurs. This protection system is intended to reduce the risk of the head and torso being trapped between the truck and the ground, but it

can not protect the operator against all possible injury in a tipover.

Make sure that the area around the lift truck is clear before making any operational checks. Be careful when making the checks. If the lift truck is stationary during a check, apply the parking brake and make sure the direction control is in **NEUTRAL**. Proceed carefully.

Check the operation of the following functions as described in the MAINTENANCE section:

- Check the operation of the horn, gauges and indicator lights.
- Operate the LIFT, TILT, and auxiliary functions to check for correct operation of the mast, carriage and attachments.
- Check the operation of the steering system.
- Check the operation of the Foot Directional Control pedal or the optional direction control lever and accelerator pedal.
- Check the operation of the service brakes and parking brake.
- Hood is securely latched.

## OPERATING TECHNIQUES

### WARNING

Before operating the lift truck **FASTEN YOUR SEAT BELT**.

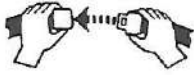

There are a number of operations, if not performed carefully, that can cause the lift truck to tip. If you have not read the **WARNING** page in the front of this Operating Manual, do so **NOW**. As you study the following information about how to properly operate a lift truck, remember the **WARNINGS**.

**NOTE:** Lift trucks manufactured before November 1, 2005 are equipped with the Automatic Locking Retractor (ALR) type seat belts. The seat belt must fasten securely. Make sure the seat belt extends and retracts smoothly and is not frayed or torn. If the seat belt is damaged or does not operate properly, it must be replaced.

**NOTE:** Lift trucks manufactured after November 1, 2005 are equipped with the Emergency Locking Retractor (ELR) style seat belt. When the ELR seat belt is properly buckled across the operator, the belt will permit slight operator repositioning without activating the locking mechanism. If the truck tips, travels off a dock, or comes to a sudden stop, the locking mechanism will be activated and hold the operator's lower torso in the seat.

### Basic Operating Procedures

Many people make the mistake of thinking that operating a lift truck is the same as driving an automobile. This is not true. It is true that some lift truck operating procedures are as simple and obvious as driving the family automobile. (e.g. Look where you are going, start and stop smoothly, etc.) But a lift truck is a special machine designed to do a much different job than an automobile. Because of the close areas in which a lift truck operates and its other operating characteristics (like rear wheel steering and tail swing), every operator must receive additional training, even if they have a license to drive an automobile.

The following discussion lists basic procedures applicable to lift truck operation.



## 1. AUTHORIZED AND TRAINED OPERATOR ONLY.

This means the operator must be trained to drive the lift truck and it means that the operator must thoroughly understand the procedures for lift truck operation. It also means that a qualified person experienced in lift truck operation must guide the operator through several driving and load handling operations before the operator attempts to operate the lift truck alone. A basic education in proper driving and load handling techniques is absolutely necessary to prepare the new operator for proper defensive driving and to expect the unexpected.

2. Operate the lift truck only in areas that have been approved for lift truck operation. Certain areas contain hazardous flammable gases, liquid, dust, fibers or other materials. Lift trucks that are operated in these areas must have special fire safety approval.



These areas must be designated to show the type of lift truck approval required for operation in the area. Changes to special equipment or poor maintenance can make the lift truck lose its special approval.

3. NO RIDERS. A lift truck is built for only one person -- the operator. It is dangerous for anyone to ride on the forks or anywhere else on the lift truck.



**⚠ WARNING**

This lift truck is designed for handling materials. A lift truck is not designed to lift people. Do not use a lift truck to lift people unless it has been determined that there is no other practical option (scaffolds, elevated work platforms, aerial baskets, etc.) to perform the needed work.



If a lift truck is used to elevate a worker, a safety platform must be attached to the forks and carriage. The platform must be specially built to meet or exceed the requirements of ITSDF B56.1. It must have a solid floor with a surface to prevent the feet of the worker from slipping, hand rail, toe board and a screen or

shield at least 7 feet high between the people on the platform and the lift mechanism.

Before anyone is allowed in the platform, lift and lower the mast slowly with the platform in place to make sure the mast functions properly. Apply the parking brake. Do not travel with people in the platform. The operator must remain at the controls. Watch for overhead obstructions.

4. Do not drive a lift truck into a elevator unless authorized to do so. Approach the elevator slowly. After the elevator is properly levelled, the lift truck must be centered so that the elevator is balanced.

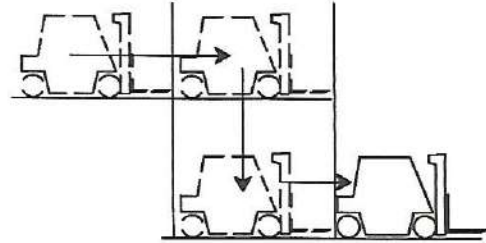

When the lift truck is in the proper position in the elevator, set the brakes, put the controls in **NEUTRAL**, and shut off the power. It is advisable that all other personnel leave the elevator before the lift truck enters or leaves.

5. Drive carefully, observe traffic rules and be in full control of the lift truck at all times. Be completely familiar with all the driving and load handling techniques described in this operating manual.

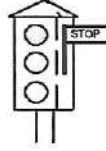

## Driving And Direction Changes

These lift trucks can have either a Foot Directional Control pedal or a direction control lever. If the lift truck has a Foot Directional Control pedal, push on the left side of the pedal to go **FORWARD**, or the right side of the pedal to go in **REVERSE**. If the lift truck has a direction control lever, move the lever toward the front of the lift truck to go **FORWARD** and toward the rear of the lift truck to go in **REVERSE**.

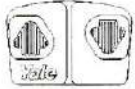

FOOT DIRECTIONAL CONTROL PEDAL



ACCELERATOR PEDAL



### **WARNING**

**DO NOT** select the travel direction if the accelerator is depressed. The lift truck will move rapidly and can cause damage or injury.

To move the lift truck, select a direction, release the parking brake and push down on the accelerator pedal.

If the lift truck is equipped with a Foot Directional Control pedal, place foot on the service brake pedal and release the parking brake. Select the direction of travel by slowly depressing on either the left or right side of the Foot Directional Control pedal. Continue pressing the Foot Directional Control pedal to move the lift truck in the selected direction.

### **CAUTION**

Changing the direction of travel to reverse when the lift truck is traveling fast can cause the load can come off the forks.

The operator can change the direction of travel while the lift truck is moving by moving the foot to the other side of the Foot Directional Control pedal, or by moving the direction control lever for travel in the opposite direction. This



action uses the motor for braking and can take place at any travel speed.

The lift truck will come to a stop and then accelerate in the opposite direction, unless the Foot Directional Control pedal or accelerator pedal is released. The braking action of the motor can be used to stop the lift truck. To stop the lift truck quickly, use the service brakes.

### Steering (Turning)

Most operators can understand the need to be careful when handling loads. But some operators do not realize that a tipover can occur with an empty lift truck because similar dynamic forces are present. In fact, the lift truck will actually tip over easier when empty, than when loaded with the load lowered. Rearward tilt, off-center loads and uneven ground will aggravate these conditions.

### **WARNING**

**TRAVEL SLOWLY WHEN TURNING.** Lift trucks can tip over even at very slow speeds. The combination of speed and the sharpness of a turn can cause a tipover. A lift truck is less stable when the forks are elevated, with or without a load.

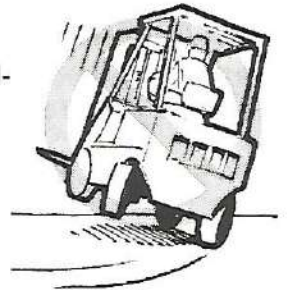

**IF THE LIFT TRUCK TIPS OVER, DO NOT JUMP OFF! HOLD FIRMLY TO STEERING WHEEL, BRACE YOUR FEET, AND LEAN FORWARD AND AWAY FROM THE POINT OF IMPACT.**

Because lift trucks are designed to work in a relatively small space, they can turn sharper than some other vehicles. Most lift trucks are steered by the rear wheels and the rear of the lift truck can move to the side very fast during a turn. This movement is called "tail swing". An operator must be aware of tail swing and always check to make sure the tail swing area is clear before turning.

## **⚠ WARNING**

Failure to observe the tail swing area when making a turn can injure or kill someone.

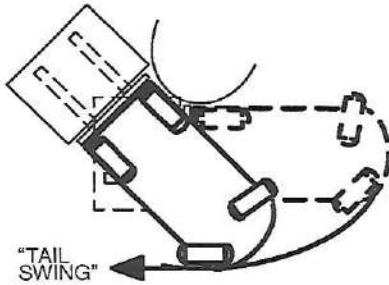

Do not turn on an incline. To reduce the possibility of a tipover, a lift truck must not be driven across an incline.

When possible, keep both hands on the steering wheel. During most loading or unloading operations, the operator steers with the left hand. The right hand is used to operate the lift, tilt, and attachment controls.

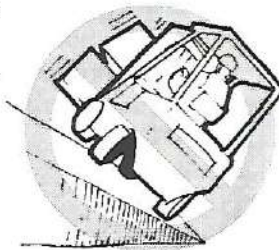

When turning the lift truck from a wide aisle into a narrow aisle, start the turn as close to the opposite stock pile as tail swing will permit. This action permits the lift truck to enter the narrow aisle going straight ahead.

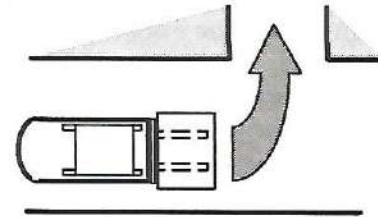

## **Load Handling, General**

1. The capacity is the maximum load that the lift truck can handle for the load condition shown on the Nameplate. The operator must know whether or not a load is within the maximum capacity of the lift truck before the load is handled.



However, such factors as weak floors, uneven terrain, special load handling attachments or loads having a high

center of gravity can mean that the safe working load is less than the rated capacity. When such conditions exist, the operator must reduce the load so that the lift truck will remain stable.

2. Handle only stable loads. A load can have unstable items that can easily shift and fall on someone.

**⚠ WARNING**

**Do not handle a load if any loose part of it is above the load backrest or any part of the load is likely to fall.**

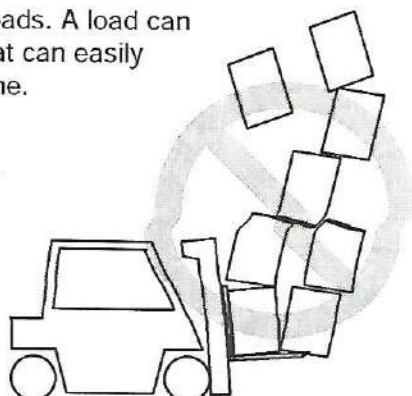

3. Position each fork the same distance from the center of the carriage. This action will help center the load on the carriage. Set the forks as far apart as possible for maximum support of the load. Center the weight of the load between the forks.

If the weight of the load is not centered between the forks, the load can fall from the forks when you turn a corner or

hit a bump. An off-center load will increase the possibility of the truck tipping over to the side.

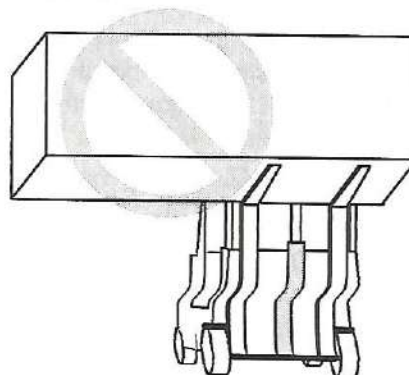

Make sure the pins that keep the forks in position are engaged so that the forks cannot move.

4. Check the condition of the driving surface. Make sure the floor will support the weight of the lift truck and the load.

**Load Handling, Lifting, Lowering And Tilting**

**NOTE:** Manual hydraulic levers are standard on the ERC040-065GH models of trucks covered in this manual. Two optional features are available to control the hydraulic functions: electronic hydraulic mini-levers (see

FIGURE 5. and TABLE 1.) or a joystick (see FIGURE 6. and TABLE 2.).

The **LIFT** and **TILT** functions are controlled by separate levers or by moving the joystick in different directions. See the **OPERATOR CONTROLS** section in the **Model Description** section for the correct operation.

The speed of the hydraulic functions is controlled by the position of the control levers. The farther the hand lever is moved from the **NEUTRAL** position, the faster the speed of the hydraulic function.

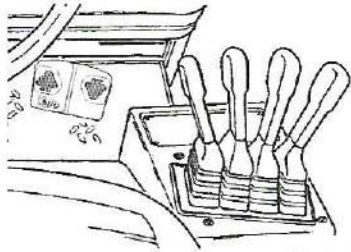

YO190034

Do not lift or hit anything that can fall on the operator or a bystander. Remember, a lift truck equipped with a YALE overhead guard and load backrest extension provides

reasonable protection to the operator from falling objects, but can not protect against every possible impact.

A lift truck without an overhead guard provides no such protection and other personnel have no overhead protection. Avoid hitting objects such as stacked material that could become dislodged and fall.

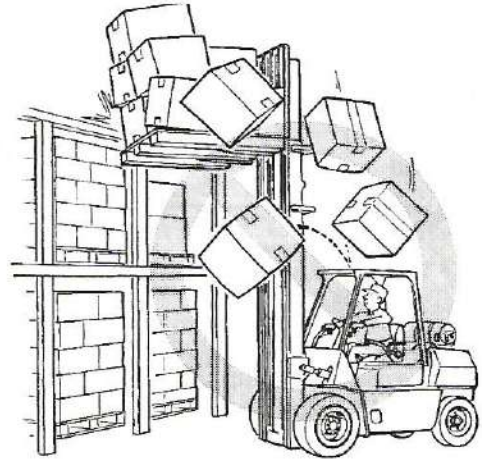

The operator must exercise care while working near such objects. Whether the lift truck is loaded or empty, do not travel with the load or carriage in a raised position.

**⚠ WARNING**

Keep yourself and all others clear of the lift mechanism. Never allow anyone under or on the forks.

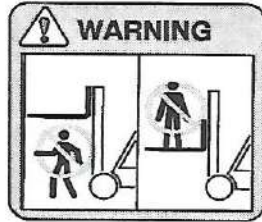

**⚠ WARNING**

NEVER put hands, arms, head or legs through the mast or near the carriage or lift chains. This warning applies not only to the operator but also a helper. A helper must not be near the load or lift mechanism while the operator is attempting to handle a load. The lift mechanism has moving parts with close clearances that can cause serious injury.

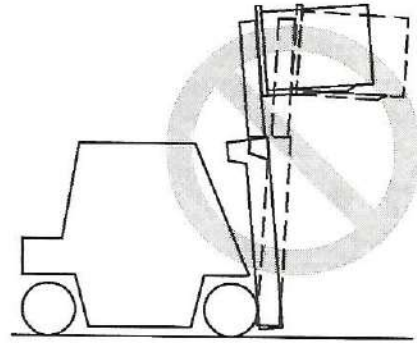
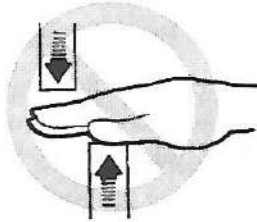

Lift and lower with the mast vertical or tilted slightly backward from vertical. Tilt elevated loads forward only when directly over the unloading place. If the lift mechanism is raised to pick up or deposit a load, keep the tilt angle in either direction to a minimum. Backward and forward tilt are helpful, but they affect side and forward stability. Do not tilt in either direction more than necessary when handling a load that is raised. The lift truck can tip forward if the mast is tilted forward with a load in the raised position.

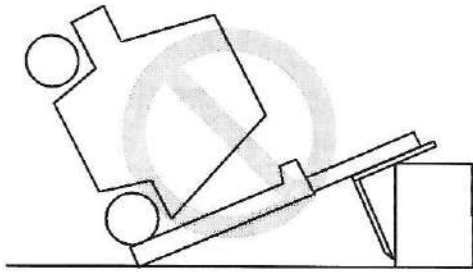

**⚠ WARNING**

The lift truck can tip over forward when the load is raised. Forward tipping is even more likely when tilting forward, braking when travelling forward or accelerating in reverse.

**IF THE LIFT TRUCK TIPS OVER, DO NOT JUMP OFF! HOLD FIRMLY TO STEERING WHEEL, BRACE YOUR FEET, AND LEAN AWAY FROM POINT OF IMPACT.**

**Load Handling,  
How To Engage And Disengage A Load**

1. Avoid fast starts. Sudden movement can cause the lift truck to tip. People can be hurt or killed and material can be damaged.

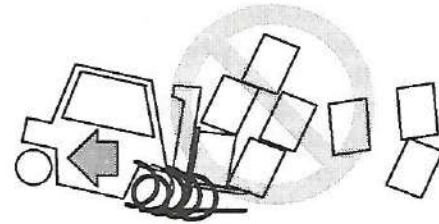

Approach the load carefully. Make sure that the truck is perpendicular to the load. Raise the forks to the proper height for engaging the load.

2. Move forward slowly until the forks are in position under the load. The forks must support at least two-thirds ( $\frac{2}{3}$ ) of the length of the load.

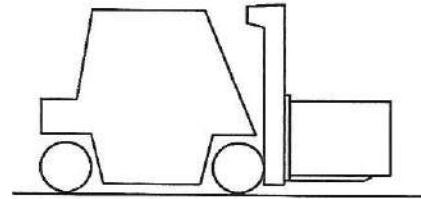

Make sure that the load is centered between the forks. Make sure that the forks do not extend past the load so that loads or equipment that are behind the load being lifted are not damaged. Lift the load a small distance from

the floor to make sure the lift truck has the capacity to lift the load.

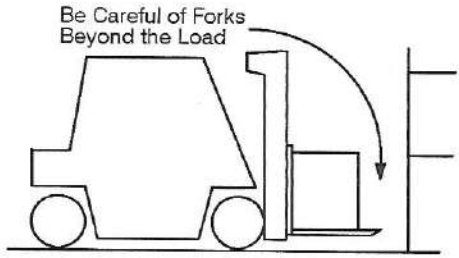

If the forks are longer than the load, move the forks under the load so that the tips of the forks do not extend beyond the load. Lift the load from the surface. Move backward a few inches, then lower the load onto the surface and inch forward to engage the load against the carriage. Tilt the mast backward just far enough to lift the load from the surface.

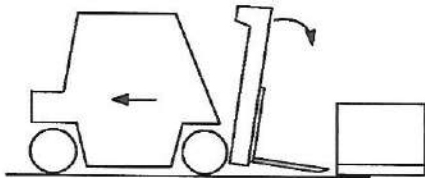

3. When a load is put on the floor, tilt the mast forward to a vertical position and lower the load. Tilt the mast forward to permit smooth removal of the forks. Carefully move the lift truck backward to remove the forks from under the load.

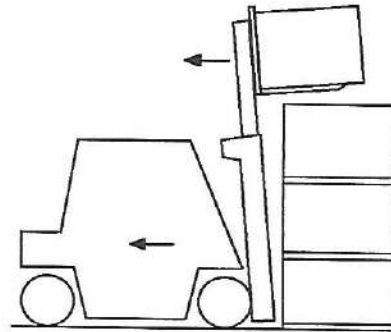

4. If the load is being removed from a stack, slowly move the lift truck away from the stack. When the load is clear of the stack, lower the load for travelling. Always travel with the load as low as possible and tilted backward. Lowering speed is controlled by the position of the control lever. Lower slowly and smoothly. Slowly return the control lever to the neutral position so that the load is not dropped

or that the lift truck is not tipped over due to the rapid stop of the load.

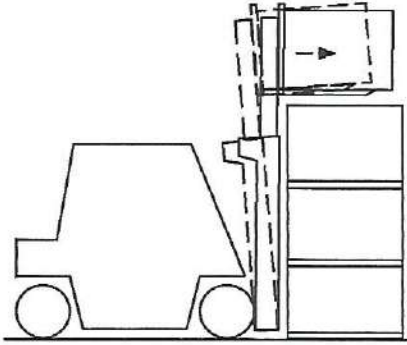

5. To put the load on a stack, align the lift truck with the stack. Lift the load to eye level and then tilt the load forward until it is level. Raise the load higher than the point where it will be placed. Do not raise the load to a point below where the load is to be placed and "jog" the load up into position. This operation uses added energy, particu-

larly with an electric lift truck. Be careful not to damage or move adjacent loads.

**⚠ WARNING**

Move carefully and smoothly when the load is raised over a stack. When the load is elevated the center of gravity of the lift truck and the load is much higher. The lift truck can tip over when the load is raised.

**IF THE LIFT TRUCK TIPS OVER EITHER TO THE SIDE OR FORWARD, DO NOT JUMP OFF! HOLD FIRMLY TO STEERING WHEEL, BRACE YOUR FEET, AND LEAN FORWARD AND AWAY FROM THE POINT OF IMPACT.**

Move forward slowly. When the load is in position, lower the load on to the stack or the rack. Lower the forks just enough to remove them from under the load. Do not lower the forks so that they will drag on the surface under the load. Carefully move the lift truck backward to remove the



forks from under the load. Lower the forks when travelling.

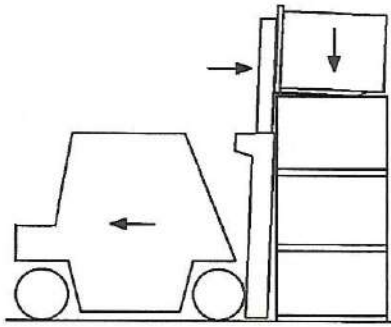

6. When lifting round objects, use a block behind the object. Tilt the mast forward so that the forks can slide along the floor under the object to be lifted. Tilt the mast fully backward to help keep the load on the forks.

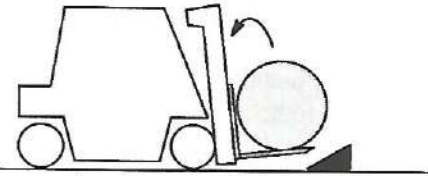
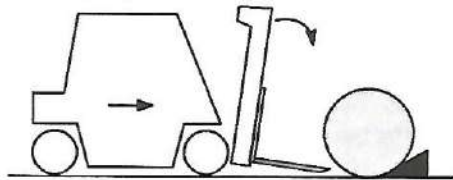

**NOTE:** Not every load can be lifted using only the forks of a lift truck. Some loads will require a special attachment.

**Load Handling, Travelling**

1. When travelling with the load lowered, keep the load against the carriage and the mast tilted fully backward. This action will help keep the load on the forks and give good forward and side stability.
2. Travel with the lift mechanism raised only enough to clear the ground or obstacles.

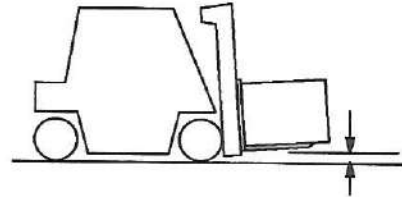

When the mast, carriage or load is in a raised position the stability of the lift truck is reduced. This stability is also critical when the lift truck is not carrying a load. The ability

of the lift truck to resist side tipping can be less on a lift truck without a load than it is on a lift truck with a load in the lowered (travel) position. Therefore, a lift truck without a load is more likely to tip sideways, especially in a turn, than a lift truck with a load carried in the lowered position.

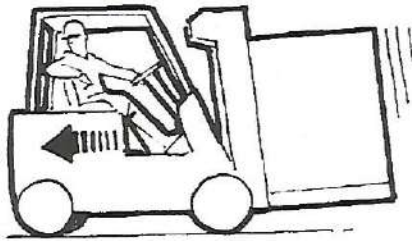

3. For better visibility with large loads, travel with the load trailing, but always keep a proper look-out in the direction of travel. Normally, direction of travel is determined by the best visibility available to the operator. If the lift truck must travel in a direction where visibility is obstructed, a look-out helper can be required.

**⚠ WARNING**

Some lift trucks have mirrors for viewing along the side to observe the tail swing area. These mirrors are

an aid to the driver, but are **NOT** driving mirrors and **must NOT** be used as such when operating in reverse. Always look in the direction of travel to avoid damage to something or injury to someone.

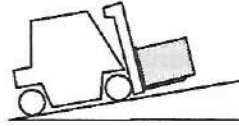

4. When travelling up or down a grade with a **heavily loaded** lift truck, keep the load upgrade to maintain control.

When operating an **unloaded** lift truck on a steep grade, keep the counter-weight upgrade.

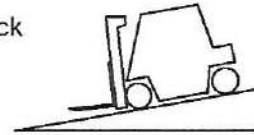

5. Watch out for pedestrians at all times. Do not drive up to anyone standing in front of an object. Use extra care at cross - aisles, doorways and other locations where pedestrians can step into the path of travel of the lift truck. Slow down when approaching blind intersections or turns and sound the horn. The horn is to warn pedestrians that there is a vehicle in the area and to be alert to possible danger.



6. Any time the lift truck is moving keep arms, legs, etc., inside the operator's compartment. Arms and legs outside the machine can be injured when passing obstructions.

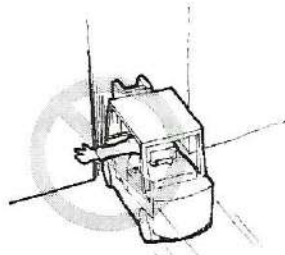

7. Avoid bumps, holes, slick spots and loose materials that may cause the lift truck to swerve or tip. If unavoidable, slow down.

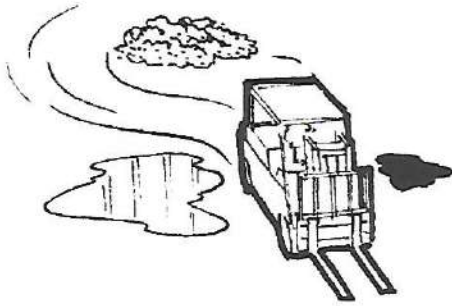

Different models of lift trucks are designed to operate under different conditions. Cushion tire models are designed

to operate on relatively smooth, firm surfaces. Always make sure you pick the smoothest route for your lift truck.

8. Watch clearances, especially forks, mast, overhead guard and tail swing.

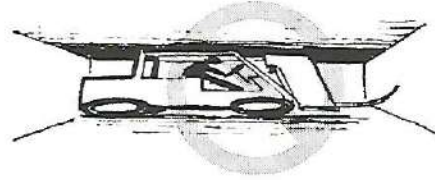

A lift truck is designed to perform a wide variety of functions within limited space. The operator must be aware that the forks can sometimes extend beyond the front of the load. If the forks extend beyond the load, the operator can hit an object or lift another load. Serious accidents can be caused by mast and overhead guards hitting pipes and beams near the ceiling.