

# FR-VII

Brand  
New



ELECTRIC REACH TRUCKS

FR-VII TRAINING TEXT

**TCM** CORPORATION

# CONTENTS

1. FEATURES	1
2. SPECIFICATION	6
3. OPERATION ON METER PANEL	8
4. MOTOR	21
5. CONTROL PANEL	23
6. ACCELERATOR	25
7. MAIN CONTACTOR AND FUSE	27
8. FAN	30
9. STEERING ANGLE POTENTIOMETER	30
<TROUBLESHOOTING>	31
10. ADJUSTMENT FOR CONTROLLER	
10-1 EXPLANATION OF MPU BOARD	32
10-1 MAKING SURE AND ADJUSTING CONTROLLER	38
11. TROUBLESHOOTING	
11-1 FUNCTION OF SELF-DEAGNOSIS	67
11-2 ERROR HISTORY MEMORY	71
12. CHARGER	
12-1 RESOLUTION AND ASSEMBLE	83
12-2 INSPECTION AND REPLACEMENT	86
12-3 INSPECTION AFTER ASSEMBLED	88
12-4 TRANSFORMER TAP CHANGIN	89
13 BATTERY AND CHARGER	75
14. SYSTEM WIRING	91



# The TCM electric reach trucks, designed with new values.

Introducing the new FR-VII series, the electric reach trucks equipped with new functions and performances to go beyond conventional reach trucks.

With the new functions and improvements, we have upgraded traveling stability, operability, economical efficiency and operator comfort. TCM has redesigned this series based on customer requirements, which resulted in enhanced features.

## Improved traveling stability

- Auto-lock suspension control system
- Front wheel brakes
- AC drive control system
- Improved frame rigidity

## Improved operability

- AC load handling control system
- Small-diameter steering wheel
- Reduced operating fatigue
- Traction control system

## Improved operator comfort

- Wider operators compartment
- Waist & hip support
- Easy battery maintenance
- Cast steel front wheel protector
- Integrated dashboard design

## Improved economical efficiency

- Longer operating hours
- Auto power off system
- Truck-mounted charger with timer (Option)



# Improved traveling stability and operability. Employs advanced functions to further evolve the electric reach trucks.



## Improved traveling stability

### Auto-lock suspension control system

A controller constantly monitors the traveling and load handling conditions, and the rear wheel suspension is automatically locked accordingly.

#### When turning

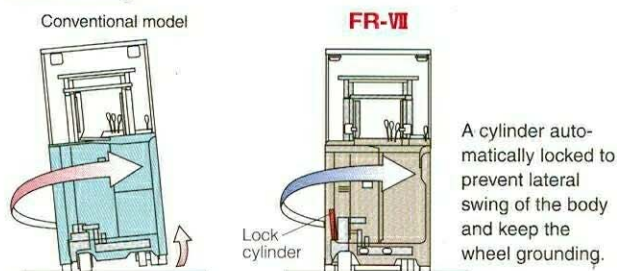

#### When load handling

This system also controls cross direction stability, and offers higher level of stability.

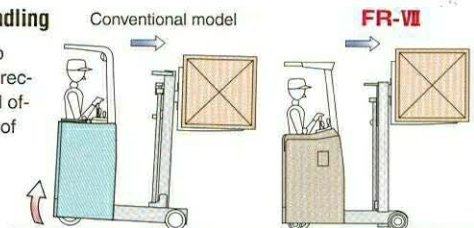

#### Wider rear wheel tread

A wider rear wheel tread is adopted together with auto-lock suspension control system to ensure higher body stability.

Conventional model  
635mm



**FR-VI**  
**680mm**

(1.5 ton model)

**M o r e U P**



## Front wheel brakes

The FR-VII is equipped with electromagnetic-controlled front wheel brakes to ensure high level of brake performance when carrying heavy loads and at slippery locations. This reduces stopping distance and prevents skid swaying during braking.

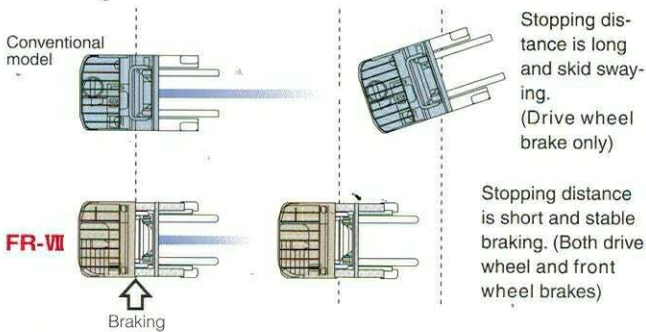
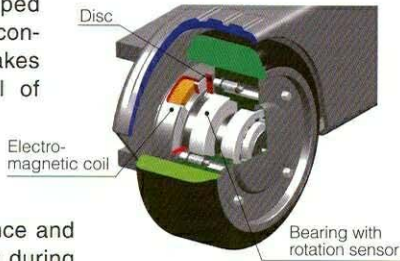

## AC drive control system

Drive wheel slipping is controlled when starting or acceleration. This system automatically adjusts the traction of drive wheel to the load and floor condition. AC motor also enables more precise control than DC motor, so start-up shock is greatly reduced. AC control also provides regenerative braking when the accelerator lever is moved to the neutral while traveling, besides conventional regenerative braking system.

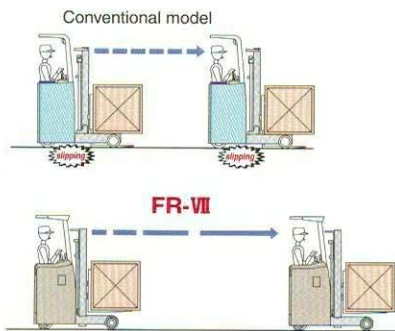

## Improved frame rigidity

The frame structure was optimally designed using FEM (Finite Element Method) strength analysis and this improves the frame rigidity by 20% over conventional model.

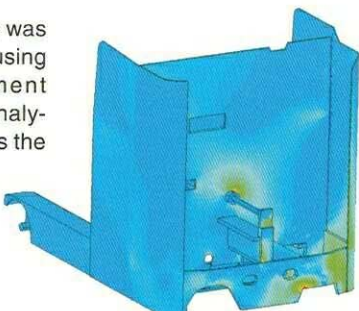

## Improved operability

### AC load handling control system

AC motor enables more precise control and ensures top-class load handling performance.

Lifting speed (1.5 ton model)

	Without load	With load
Conventional model	530mm/s	310mm/s
<b>FR-VII</b>	<b>570mm/s (8%up)</b>	<b>330mm/s (7%up)</b>

### Small-diameter steering wheel

The steering wheel is 35 mm smaller compared with conventional model, and requires even less operating strength, and enhances maneuverability.

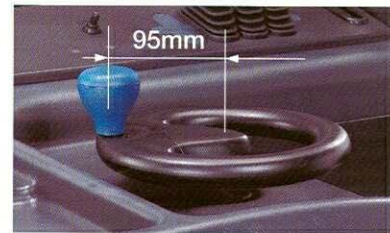

Conventional model  
130mm



## Reduced operating fatigue

Operating force of the control lever is 20% less than that of conventional model. This significantly reduces operator fatigue during load handling operation.

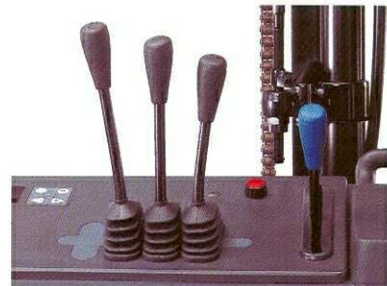

## Traction control system

When climbing slopes or getting out of the concaves of the road, the controller automatically increases the traction of drive wheel.

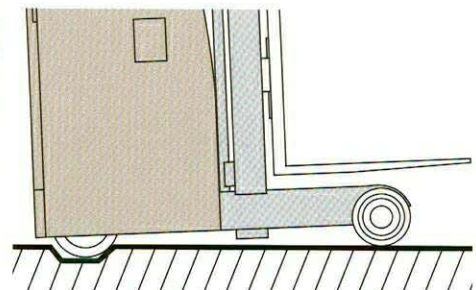



# A new appearance of electric reach trucks, with superior economical efficiency and operator comfort.

## Improved economical efficiency

### Longer operating hours

The FR-VII achieves 8.5 hours of operation per charge (Based on 55% work ratio) by minimizing battery power consumption during load handling operation. The three types (accelerator off, switch back, braking) of braking regeneration return the energy to the battery to lengthen operating hours.

### Auto power off system

This system will automatically shut off the main power to save the battery power in case the truck is not operated for 15 minutes even if the main key switch is "ON". The hour meter also stops automatically to enable accurate operation management.

### Truck-mounted charger with timer (Option)



This charger enables you to set the start time of charging beforehand. This enables the optimal charging state when starting work after holiday.

## Improved operator comfort

### Wider operators compartment

Changes in the compact AC motors layout and compact design of the side cover enlarges operators compartment. This compartment is roomy and provides ease of access.



Comparison of 1.5 ton model

	Floor depth	Floor width
Conventional model	390mm	475mm
<b>FR - VII</b>	<b>420mm</b>	<b>530mm</b>

**G r o w u p**

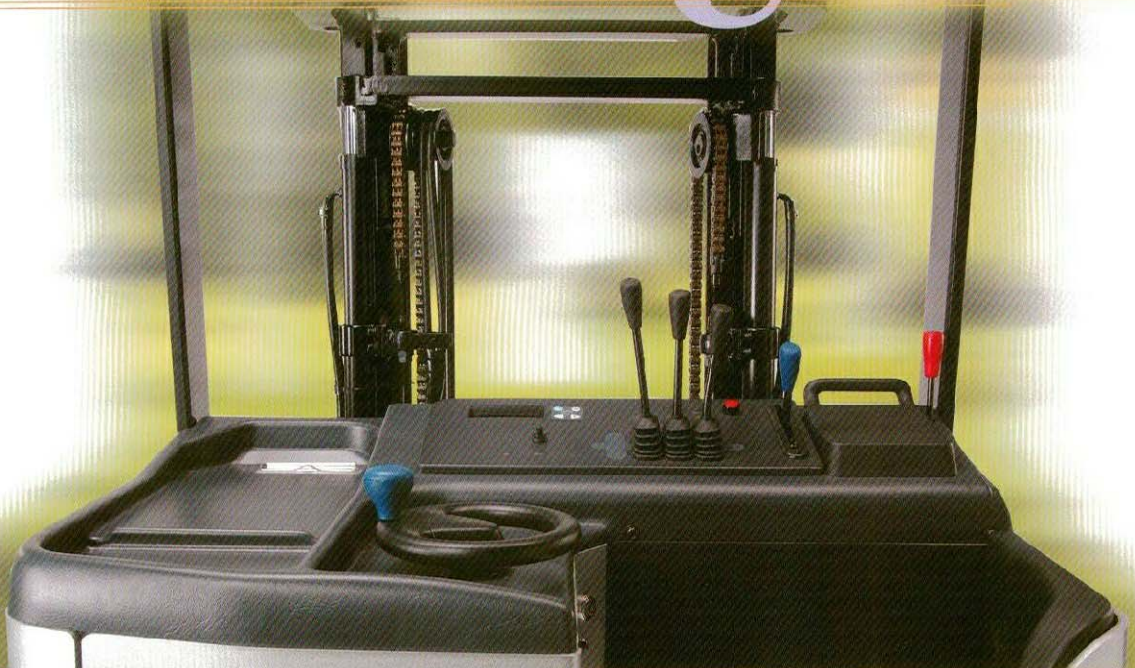





## Waist & hip support

The waist & hip support is optimal shape studied from 3D viewpoint, and equipped with vertical slide adjustment by 30 mm. This design firmly supports the operator's body, and enables work with a stable posture.

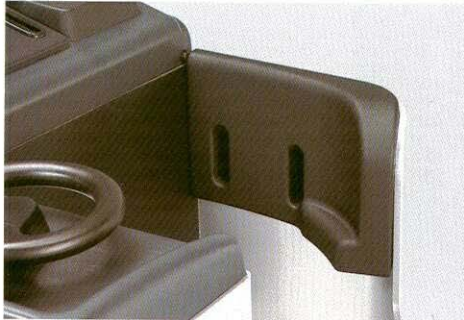

## Integrated dashboard design

Functional dashboard panel is uniformly made and it provides better waterproofing property. Rubber boots are applied for control levers to prevent splash of water and dust from going inside the panel.

(The panel uses material with good recycling efficiency.)



## Easy battery maintenance

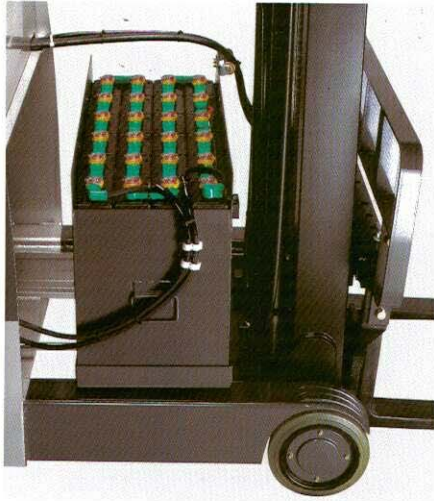

Batteries are pulled forward, out of the compartment for easy access. This makes maintenance and replacement easy, quick and safe with little fatigue.

## Turn signal with self-canceling mechanism (Option)

This mechanism detects steering wheel rotation and automatically cancels the turn signal.

## Cast steel front wheel protector

The edge of front wheel protector is rounded, and this prevents reach-legs and pallets from scratching during reach retraction of pallets.

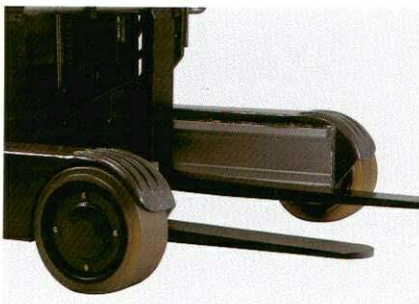

## OPTION COLOR Yellow



Some items and components in photo may be optional.



## Configuration for export specification

Model	FR10-7	FR13-7	FR14-7	FR15-7	FR18-7	FR20-7	FR25-7
	FR10-7H	FR13-7H	FR14-7H	FR15-7H	FR18-7H	FR20-7H	FR25-7H
Arm rest with assist grip	○	○	○	○	○	○	○
Auto-lock suspension system	○	○	○	○	○	○	○
Automatic anti-slip control/drive wheel	○	○	○	○	○	○	○
Auto power off	○	○	○	○	○	○	○
Auto traction control	○	○	○	○	○	○	○
Back-up buzzer	○	○	○	○	○	○	○
201Ah/5HR	△	△					
225Ah/5HR	△	△					
280Ah/5HR			△	△	△		
312Ah/5HR			△	△	△		
320Ah/5HR						△	△
370Ah/5HR			△	△	△		
390Ah/5HR						△	△
440Ah/5HR						△	△
Built-in charger(Truck-mounted)	△	△	△	△	△	△	△
Central greasing system	○	○	○	○	○	○	○
Chime(Buzzer)/forward traveling	△	△	△	△	△	△	△
Battery fuel	○	○	○	○	○	○	○
Clock with calendar	○	○	○	○	○	○	○
Hourmeter	○	○	○	○	○	○	○
Odometer	○	○	○	○	○	○	○
Safety monitor	○	○	○	○	○	○	○
Speedometer	○	○	○	○	○	○	○
Documents clip	○	○	○	○	○	○	○
Electric power steering(EPS)	○	○	○	○	○	○	○
Electro-magnetic front wheel brake	○	○	○	○	○	○	○
Head light	○	○	○	○	○	○	○
Neutral safety system	○	○	○	○	○	○	○
Operator tool kit	○	○	○	○	○	○	○
Overhead guard	○	○	○	○	○	○	○
Rear working light	△	△	△	△	△	△	△
Regenerative braking							
Accel-off brake	○	○	○	○	○	○	○
Brake	○	○	○	○	○	○	○
Down-slope travel	○	○	○	○	○	○	○
Switch-back	○	○	○	○	○	○	○
Shock-less cylinder (for VM)	○	○	○	○	○	○	○
Small-dia stg wheel	○	○	○	○	○	○	○
Spot light	△	△	△	△	△	△	△
Stational charger(with MICON)	△	△	△	△	△	△	△
Stop & backup lamp	△	△	△	△	△	△	△
Turn signal lights(with self-cancelling)	○	○	○	○	○	○	○
Waist & hip supporter	○	○	○	○	○	○	○

○ : STD △ : Optional

### Other optionals:

#### Equipment & Accessories

Battery change stand  
 Central electrolyte re-fill system  
 C-lug drive Tire  
 Cold strage package(-35°C)  
 Fire extinguisher  
 Fishery industry package  
 Headlight guard  
 Mast guard  
 Non-marking Tire  
 Overhead guard canvas  
 Polyurethane Tire  
 Rotating warning light(Red, Yellow)  
 Side view mirrors

Other on request

#### Loading & Attachment

Alternative fork lengths  
 Fork extentions(Sleeves)  
 Load grabs  
 Rotating clamps  
 Side shifter  
 Wide-finger bar(for VM)  
 Wide view full free 2stage mast(VFM)  
 Wide view full free 3stage mast(VFHM)

Other on request



# STANDARD SPECIFICATIONS: Stand-up Rider Type - Electric Reach Trucks

Model			FR10-7	FR10-7H	FR13-7	FR13-7H	FR14-7	FR14-7H	FR15-7	FR15-7H	FR18-7	FR18-7H	FR20-7	FR20-7H	FR25-7	FR25-7H		
<b>■Performance</b>																		
Max. load	: (load center)	kg (mm)	1000		1250		1350		1500		1800		2000		2500			
Max. fork height		mm	3000	4000	3000	4000	3000	4000	3000	4000	3000	4000	3000	4000	3000	4000		
Free lift		mm	410		410		410		410		410		410		410			
Speed lifting	: with load	mm/s	350		340		330		330		310		270		250			
	: without load	mm/s					570		570		570		480		480			
Tilt angle range	: forward / backward	deg					3 / 5		3 / 5		3 / 5		3 / 5		3 / 5			
Travel speed	: with load	km/h					9.5		9.5		9.5		9.5		9.5			
	: without load	km/h					10.5		10.5		10.5		11.5		11.5			
Min. turning radius (outside)		mm	1350	1490	1490	1490	1560	1560	1750	1750	1750	1750	1795	1965	1965	1965		
Reach stroke		mm	405	555	555	555	580	580	725	725	725	725	650	795	795	795		
<b>■Dimensions &amp; Weight</b>																		
Overall length	: with forks	mm	2000		2000		2070		2070		2105		2110		2200		2225	
Overall width		mm	E		E		1090		1090		1090		1090		1200		1200	
Overall height	: Mast	mm	1995	2495	1995	2495	1995	2495	1995	2495	1995	2495	2035	2535	2035	2535		
	: Head guard	mm	H		H		2260		2260		2260		2315		2315			
	: Max. height fork raised	mm	3620	4820	3620	4820	3620	4820	3620	4820	3620	4820	3930	4930	3930	4930		
Fork size	: L x W x T	mm	J		J		920 × 100 × 35		920 × 100 × 35		920 × 100 × 38		920 × 122 × 40		920 × 122 × 40			
Lateral fork adjustment (outside of forks)		mm	K		K		250 ~ 720		250 ~ 720		250 ~ 720		290 ~ 735		290 ~ 735			
Wheelbase		mm	1095	1245	1245	1245	1345	1345	1525	1525	1525	1525	1530	1700	1700	1700		
Tread	: front	mm	M		M		975		975		975		1065		1065			
	: rear	mm	N		N		680		680		680		725		725			
Fork Overhang (Centerline of front axle to front face of forks)		mm	O		O		170		165		170		165		165			
Service weight (with STD. battery)		kg	1860	1970	2000	2080	2050	2130	2160	2140	2230	2310	2740	2890	2880	3000		
<b>■Electric Motor &amp; Controller &amp; Drive system</b>																		
Battery	Voltage / Capacity	(STD.)	48V / 201AH		48V / 201AH		48V / 201AH		43V / 280AH		43V / 280AH		48V / 320AH		48V / 320AH			
	(5 Hour Rating)	(Option)	48V / 225AH		48V / 225AH		48V / 225AH		43V / 370AH		43V / 370AH		48V / 390AH		48V / 390AH			
Electric motors	: drive motor	kw/60min					4.3		4.3		4.3		5.0		5.0			
	: hydraulic motor	kw/5min					6.8		6.8		6.8		11.0		11.0			
Controller type	: drive control						IGBT Inverter		IGBT Inverter		IGBT Inverter		IGBT Inverter		IGBT Inverter			
	: load handling control						IGBT Inverter		IGBT Inverter		IGBT Inverter		IGBT Inverter		IGBT Inverter			
Brake system							Disc / Electro-magnetic disc		Disc / Electro-magnetic disc		Disc / Electro-magnetic disc		Disc / Electro-magnetic disc		Disc / Electro-magnetic disc			
<b>■Tire &amp; Steering System</b>																		
Number (X=driver)	: front / rear						2 / 1x + 2 (x=drive)		2 / 1x + 2 (x=drive)		2 / 1x + 2 (x=drive)		2 / 1x + 2 (x=drive)		2 / 1x + 2 (x=drive)			
Size	: front, load		255 x 114 rubber solid		255 x 114 rubber solid		255 x 114 urethan solid		255 x 114 urethan solid		255 x 114 urethan solid		267 x 135 urethane solid		267 x 135 urethane solid			
	: rear, drive						350 x 145 rubber solid		350 x 145 rubber solid		350 x 145 rubber solid		380 x 165 rubber solid		380 x 165 rubber solid			
	: rear, caster						178 x 73 rubber solid		178 x 73 rubber solid		178 x 73 rubber solid		204 x 76 rubber solid		204 x 76 rubber solid			

7

## LOAD CHART

Standard models

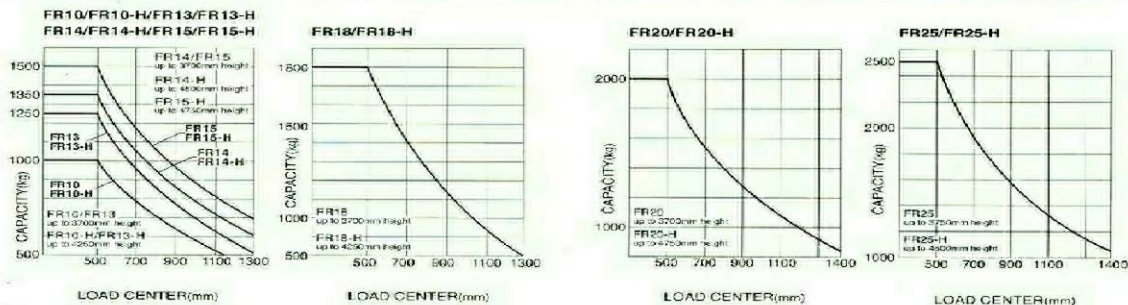

## STANDARD DIMENSIONS

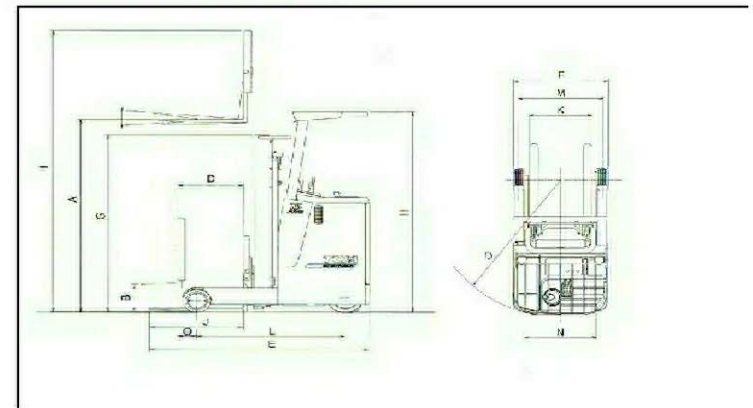



# 3 EACH PART NAME AND FUNCTION

## INDICATOR PANEL

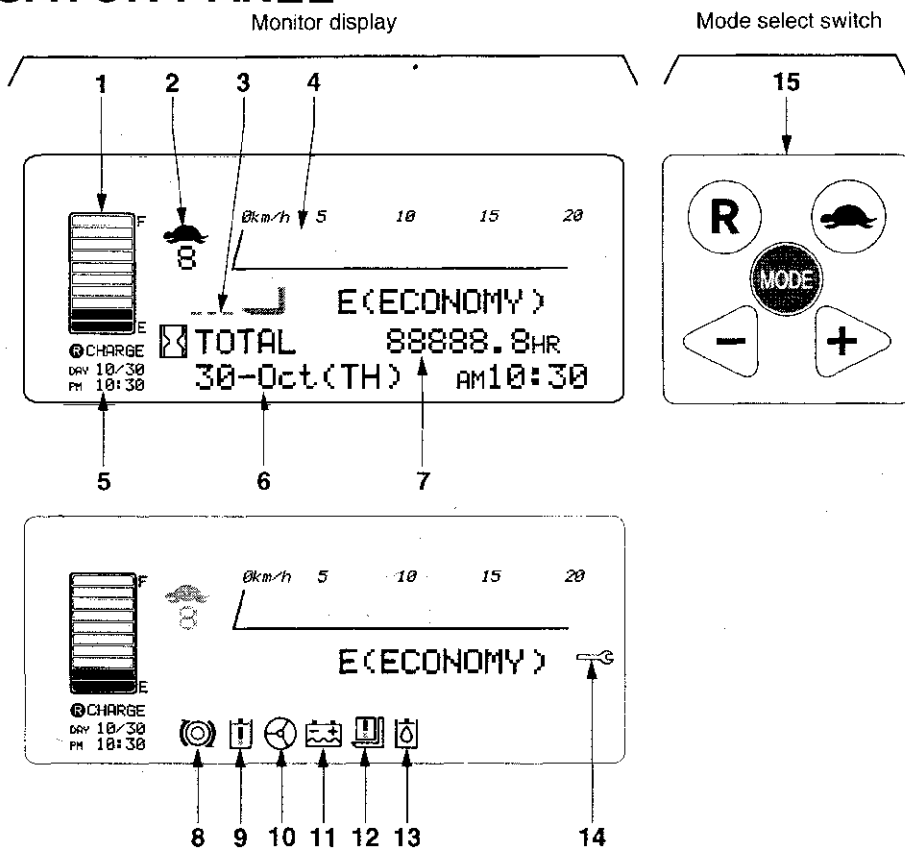

1. Battery discharge indicator
2. Slow speed mode monitor (Turtle mark)
3. Fork horizontal indicator (Option)
4. Travel speed meter
5. Battery charge reservation indicator (Option with built-in charger)
6. Calendar and clock
7. Hour meter
8. Safety monitor for traction circuit
9. Safety monitor for hydraulic circuit
10. Safety monitor for power steering circuit
11. Safety monitor for battery electrolyte level (Option with GS battery)
12. Safety monitor for overload (Option)
13. Safety monitor for hydraulic oil level (Option)
14. Service (spanner) mark
15. Mode select button

### NOTE

Icons of 8 to 14 shown in the illustration are displayed for the explanation. It is not actual indication. They are displayed when abnormalities are occurred.



## ■ BASIC OPERATION

Turn the key switch to on.

The factory-set safety monitor icons appear. If there is nothing unusual, "OK!" appears and the Book icon meaning that "See the Operation and Maintenance Manual" blinks three times.

The basic screen (which is always shown during operation) appears. If there is something unusual, the error display appears.

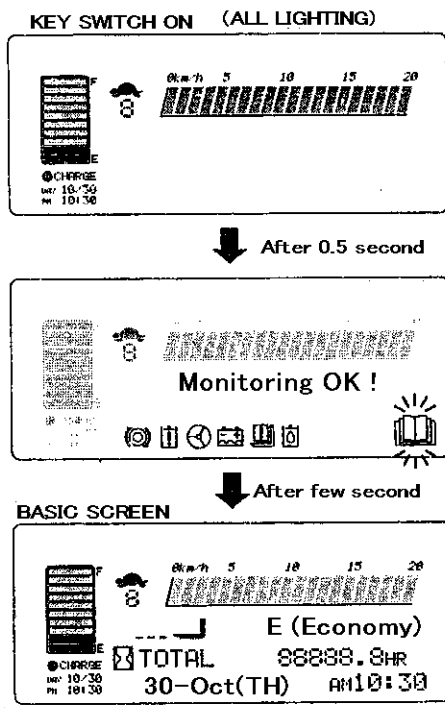

If the truck is moved or load handling operation is performed immediately ( or within 3 to 4 seconds ) after the key switch is turned to ON, monitoring is carried out before the basic screen appears.



If the error screen appears, contact your TCM dealer.

## ▶ SCREEN SELECTION BUTTONS



If you run the truck or operate the hydraulic controls when any of the above screen is displayed, the display will return to the basic screen.

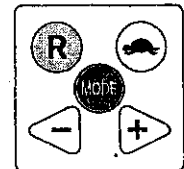

Screen

- Press the **R** button → **Reserved charge screen**

  - SPECIFY THE STARTING CHARGE DATE

... How to show the display Refer to section ⑤ in page 26
- Press the **MODE** button → **Setup screen**

  - SET MAXIMUM TRAVEL SPEED FOR LOW-SPEED TRAVEL
  - SET TRAVEL
  - SWITCH OVER HOUR METER AND ODOMETER
  - SET DISPLAY BRIGHTNESS
  - SET NEUTRAL REGENERATIVE FORCE

... Refer to VARIOUS SETTING MODE in page 15.
- Press the **←** button → **Date and time screen**

  - SET DATE, TIME AND DAY OF THE WEEK

... Refer to VARIOUS SETTING MODE in page 18.
- PRESS either of **←** or **→** → **Hour meter confirmation screen**

  - MAKING SURE HOUR METER

... Refer to VARIOUS SETTING MODE in page 12.



## MONITOR DISPLAY

The forklift truck checks its own conditions and indicates the results via text and graphics on the LCD monitor

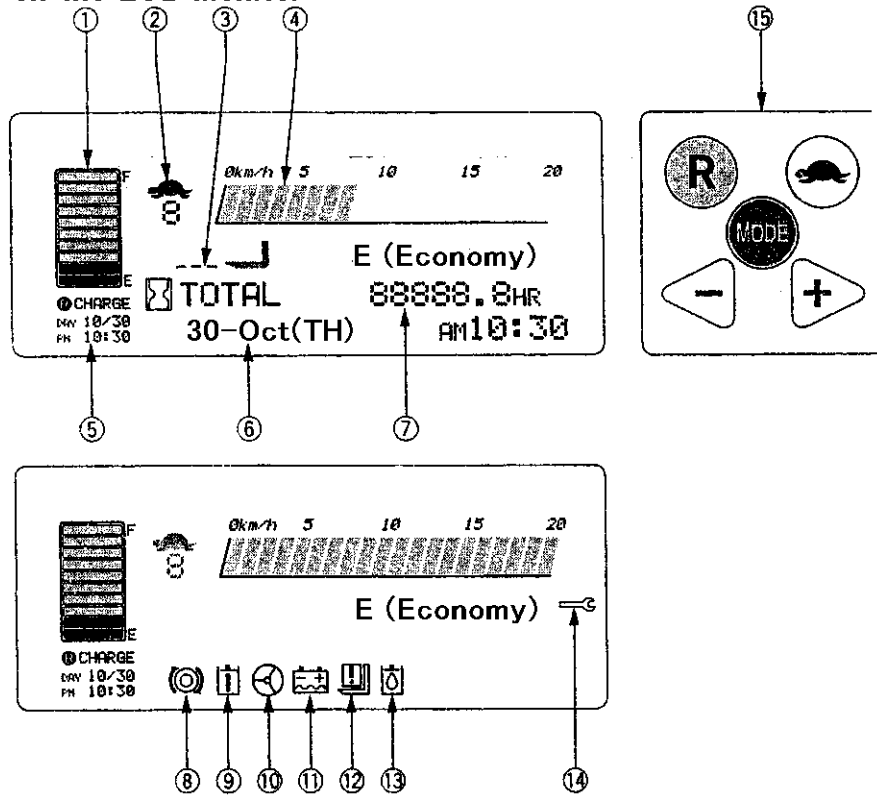

The safety monitor mark (8)-(14) show the function to explain. In fact, it doesn't display state of the key switch ON. These marks blink only error. (Normally, it is not shown.)

### ① Battery discharge indicator

The battery discharge indicator indicates the battery's condition of charge.



The longevity of the battery shortens, if you use it until the truck doesn't move.

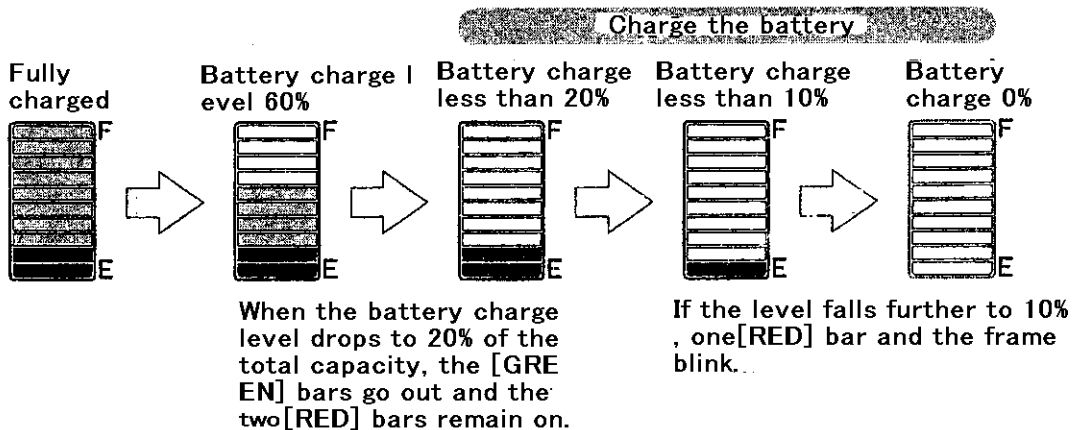



● **Lift interrupt (Option)**

When all green segments are disappeared and two red segments are lit, the lift speed is reduced by half.

At the same time, " \* Charge the battery \* " message appears on the screen.

When the truck is continued to use, only one red segment is started to flash and the lift function is interrupted.

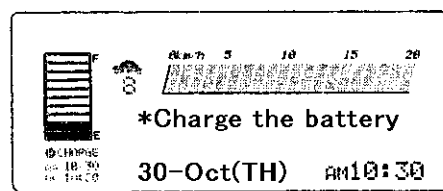

Blinking [RED]

↓ After 10minutes

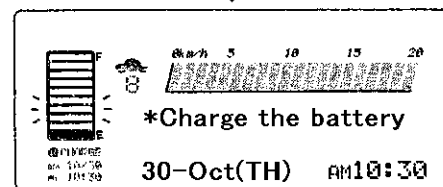

Blinking capacity meter

② **Slow speed mode monitor (Turtle mark)**

When the turtle button is pushed, the turtle mark is indicated on the screen with the preset speed.

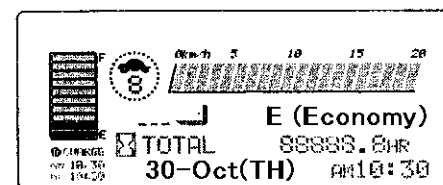

③ **Fork horizontal indicator (Option)**

This mark is indicated when the fork is horizontal and possible to use the laser pointer.

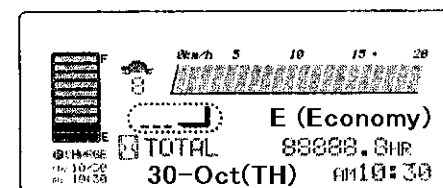

④ **Speed meter**

The traveling speed is displayed on the screen.

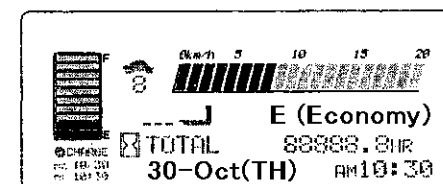

⑤ **Reserve charge indication (Option)**

The reserved date and time to start charging the battery is displayed. Refer the section of "Battery and charger" on FR-75 OPERATOR'S MANUAL or WORKSHOP MANUAL for details.

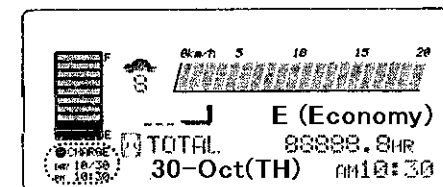

⑥ **Date and time (Calendar and clock)**

The current date and time are displayed. If the "MODE" button is pushed for more than 3 seconds, the display is changed to the setting screen. Refer the page 30 for details.

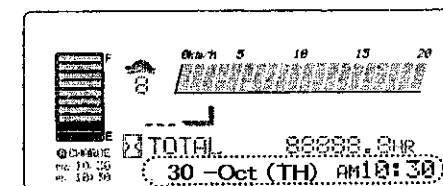



### 3 EACH PART NAME AND FUNCTION

#### ⑦ Hour meter

The hour meter shows the total hours of turning on the key switch.

(The actual operating hours can be displayed as option.)

It is useful to know the total operating hours for the daily job management and scheduling of the periodical inspection.

When pushing " $\leftarrow$ " or " $\rightarrow$ " button, each individual hours for travel, hydraulic and total are displayed for 5 seconds.

The normal screen and hour meter screen are changed by turn by pushing " $\leftarrow$ " or " $\rightarrow$ " button.

After 5 seconds, the normal screen is displayed.

The odometer can be displayed in the normal screen instead of hour meter. Refer the meter mode setting in the setting mode section.

BASIC SCREEN

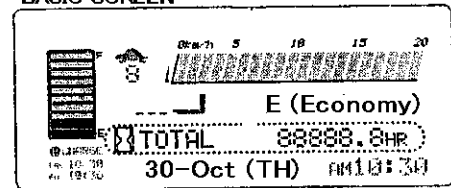

PRESS  $\leftarrow$  or  $\rightarrow$

After displayed 5 seconds, shift automatically to basic screen

DISPLAY HOUR METER MODE

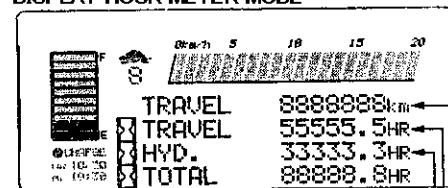

TOTAL HOUR METER  
TOTAL USING HYD HOURS  
TOTAL TRAVELING HOURS  
TOTAL TRAVELING DISTANCE



The hour meter screen is returned to the normal screen even less than 5 seconds by operating traveling or hydraulic function.

When the screen displays the odometer, the word of "TRAVEL" is flashed while travelling.

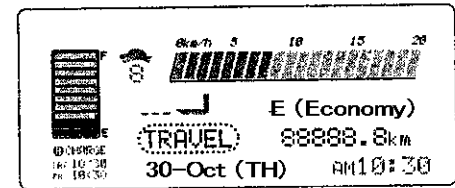

#### ⑧ Safety monitor (for travel circuit)

When fault is detected in the travel circuit, the travel icon flashes and the presumed defective part name is displayed.

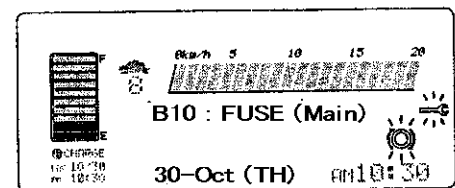

#### ⑨ Safety monitor (for hydraulic circuit)

When fault is detected in the hydraulic circuit, the hydraulic icon flashes and the presumed defective part name is displayed.

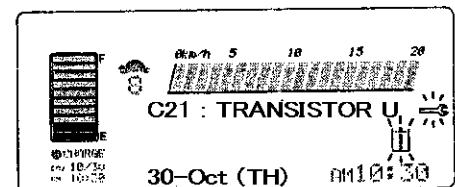

#### ⑩ Safety monitor (for steering circuit)

When fault is detected in the power steering circuit, the steering icon flashes and the presumed defective part name is displayed.

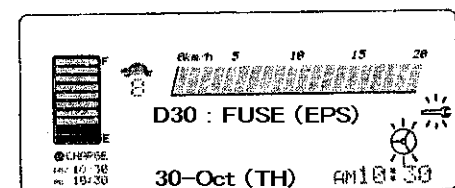



**⑪. Safety monitor (for battery electrolyte level) (for GS battery only)**

When the electrolyte level is lower than the specific level, the battery icon flashes and " \*Add purified water\*" message is displayed.

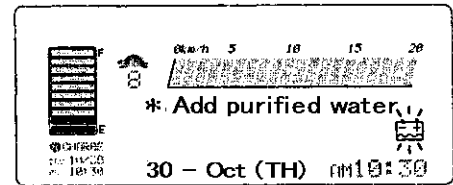
**⑫. Safety monitor (for overloading) (Option)**

When overloaded, the load icon flashes and " \*Over load. Reduce load\*" message is displayed on the screen.

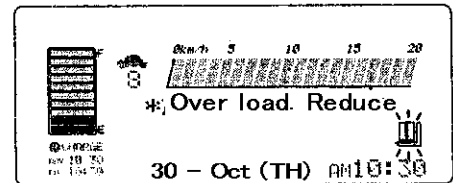
**NOTE**

When [name of a damaged part] or " \*REFILL FORK OIL\*" is lit, please contact the your local Nichiyu dealer.

**⑬. Safety monitor (for hydraulic oil) (Option)**

If the hydraulic oil level is low, the icon is flashed and the message of " \*Add lubrication oil\*" is displayed.

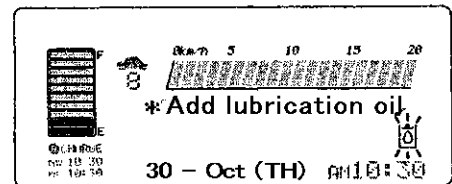
**NOTE**



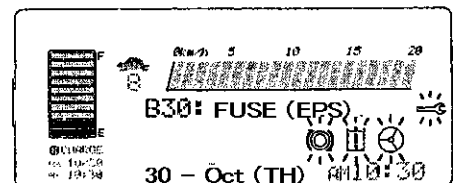

The hydraulic oil level sensor detects the oil level for 2 seconds after turning on the key switch. So, the mast must be retracted completely and fork must be lowered on the ground before turning on the key switch. Otherwise, the warning message of " \*REFILL HYDRAULIC OIL\*" may be displayed even the quantity of oil is normal.

**⑭. Service icon**

The service icon warns the fault of the forklift truck to an operator. If any faults are detected, the spanner mark is flashed and the presumed defective part name is displayed. If some problems are occurred at the same time, each part name is scrolled alternatively for every 5 seconds.



**CAUTION**

- If any of the following errors occurs, the travel, hydraulic and EPS circuits will be interlocked.
  - B11: Transistor U (travel)
  - B12: Transistor V (travel)
  - B13: Transistor W (travel)
  - C21: Transistor U (hydraulic)
  - C22: Transistor V (hydraulic)
  - C23: Transistor W (hydraulic)
  - \*Travel system electric current error\*
  - \*Hydraulic system electric current error\*
  - \*The truck has made an emergency stop.\*
- While any error message is being indicated all the selection buttons—, , , —are disabled (you cannot display the charge reserve screen and others).

**⑮. Mode select button**

Change the screen to each mode by pushing these buttons.

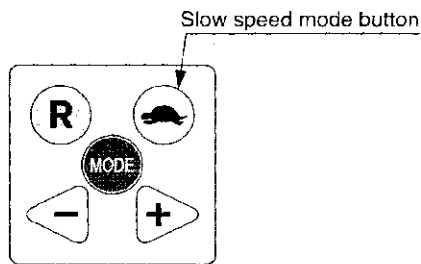

Mode select button

121709E

○ **Slow speed mode button**

The slow speed mode is activated by pushing this button.

Normal traveling mode (When the slow speed button is off)

The slow speed mode indicator () is not displayed.

Slow speed mode (when the slow speed button is on)

The turtle icon and preset speed are displayed on the screen.

- If the value of the slow speed mode is preset, the maximum traveling speed can be changed in the normal mode and slow speed mode by pushing the turtle button.

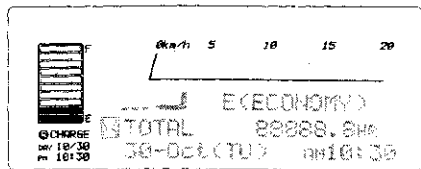

When the slow speed button is off (Turtle mark is not displayed)

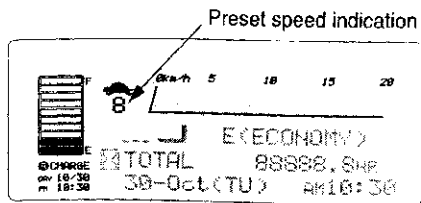

When the slow speed button is on (Turtle mark is displayed)

121707E



- [1] Slow speed setting
- [2] Travel mode setting
- [3] Meter mode setting
- [4] Display mode setting
- [5] Regeneration (Neutral) mode setting
- [6] How to set the date and time

**CAUTION**

- These settings are invalid while traveling or depressing the brake pedal.
- If traveling or hydraulic operation is done while setting, the display is returned to the normal screen immediately.

When pushing the "MODE" button, the mode selection screen is displayed. If pushing the "MODE" button again, the normal screen is displayed again.

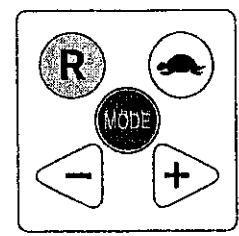

MODE SELECT BUTTON

**NOTE**

- When setting the mode of next [1] to [5], each button works as below.
- "◀" and "▶" buttons : Move the cursor to select the value.
  - "R" button : Move the cursor to the next item.
  - "MODE" button : Back the cursor to the previous item.

**[1] Slow speed setting**

This mode sets the limited maximum travelling speed under the slow speed mode.

Make sure the turtle button is pushed and the turtle icon is flashed. Then, push "◀" or "▶" button to set the speed.

The maximum speed can be set to 7 steps of 2, 3, 4, 5, 6, 7 and 8km/h.

After setting, push "R" button to move the cursor to the travel mode setting.

If push the "MODE" button, the normal screen is displayed.

BASIC SCREEN The current low-speed setting is displayed.

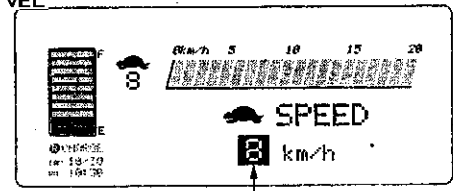
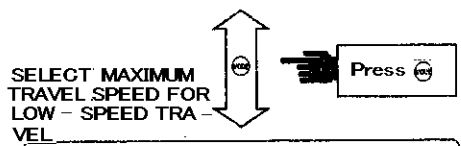
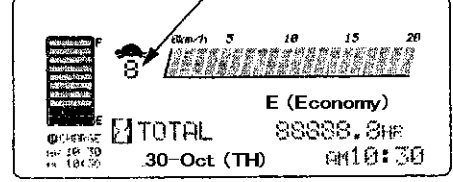

Select low-travel speed by ◀▶ button

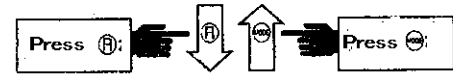

**[2] TRAVEL CONTROL MODE SELECTION**

## [2] Travel mode setting

This screen is used to set the travel mode.

Make sure that the current traveling mode indication is flashed. Push " $\leftarrow$ " or " $\rightarrow$ " to select the mode.

After selection, push " $\text{R}$ " button to move the cursor to the meter mode setting.

If pushing the " $\text{MODE}$ " button, the cursor is moved to the slow speed mode setting.

The traveling mode can be set to the next three modes.

### E (ECONOMY)

This mode is convenient for the slow speed inching.

This mode saves the battery energy consumption also.

### N (NORMAL)

This is the normal traveling mode. The quick acceleration and smooth inching can be realized.

### P (POWER)

This is the most powerful mode for acceleration.

## [3] Meter mode setting

The hour meter or odometer can be selected by this mode on the normal screen.

When the cursor is located on the meter mode, "HR" (hour meter) or "km" (odometer) can be selected by pushing " $\leftarrow$ " or " $\rightarrow$ " button.

After selection, push " $\text{R}$ " button to move the cursor to the display mode.

If pushing the " $\text{MODE}$ " button, the cursor is returned to the traveling mode area.

The display is switched from the normal screen to the meter mode screen by pushing " $\leftarrow$ " or " $\rightarrow$ " button.

The meter mode screen has 2 kinds. Refer below for details.

TRAVEL MODE SELECTION SCREEN

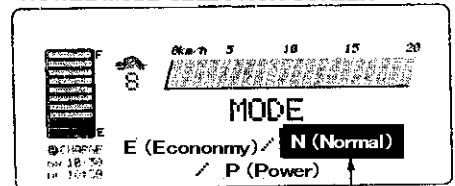

SELECT TRAVEL MODE BY  $\leftarrow$   $\rightarrow$  BUTTON

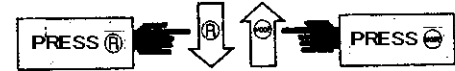

**3** TO SELECT HOUR METER, TRAVEL DISTAND DISPLAYING SCREEN

HOUR METER AND ODOMETER SELECTION SCREEN

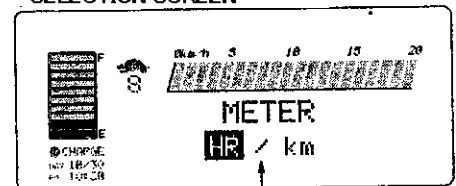

SELECT METER MODE BY  $\leftarrow$   $\rightarrow$  BUTTON

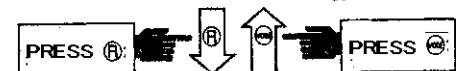

**4** TO DISPLAY BRIGHTNESS SETTING SCREEN



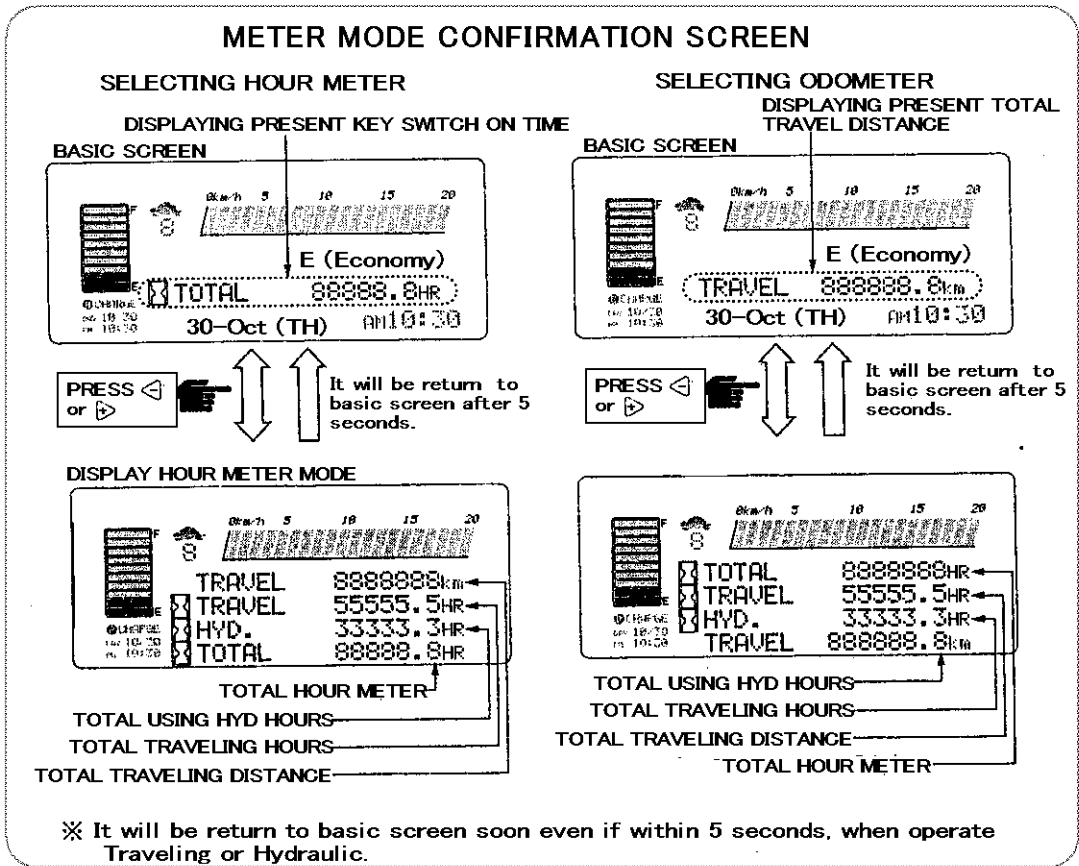

#### [4] Display mode setting

This mode sets the brightness of the screen.

Make sure that the cursor is located on the brightness setting area. Push the "◀" or "▶" button to select the brightness for the best. It can be selected 7 steps (from 0 to 7).

After setting, push "Ⓡ" button to get the coast mode setting screen.

If pushing the "MODE" button, the cursor is returned to the view (contrast) setting.

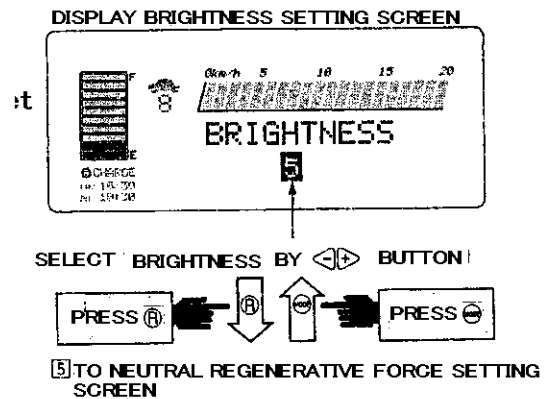

**NOTE**

Refer the table below for the brightness settings.

BRIGHTNESS (Intensity of back light)	
1 Dark	7 Bright



**[5] Regeneration (Neutral) mode setting**

This mode can be set the regenerative braking force when releasing the accelerator pedal while travelling. Make sure that the REGEN(NEUTRAL) mode screen is displayed. Then push "←" or "→" button to select the strength.

The braking strength can be set to 4 steps of "NON" (No braking), "LOW", "MID" (Middle) and "HIGH".

Set neutral regenerative force display

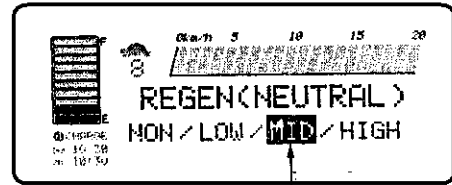

SET NEUTRAL REGENERATIVE FORCE BY ←→ BUTTON

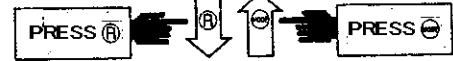

TO BASIC SCREEN

**NOTE**

It is set to "MID" (Middle) as default.

After setting, push "R" button to return to the normal screen.

If pushing the "MODE" button, the display mode setting screen is displayed.

**[6] How to set the date and time**

When the "MODE" button is pushed for more than 3 seconds, the date and time setting screen is displayed.

Push "MODE" button to return to the normal screen.

BASIC SCREEN

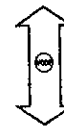
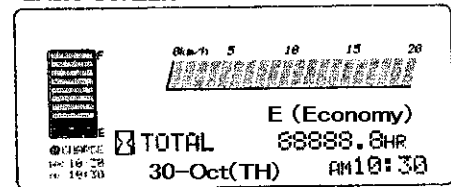

PRESS (MODE) FOR 3 SECONDS OR MOR

**CAUTION**

If traveling or hydraulic operation is done while setting, the display is returned to the normal screen immediately.

**NOTE**

When setting the mode of next [1] to [6], each button works as below.

- "←" and "→" buttons : Move the cursor to select the value.
- "R" button : Move the cursor to the next item.
- "MODE" button : Back the cursor to the previous item.

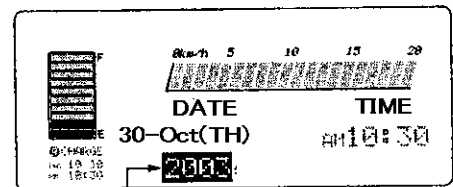

BLINKING "YEAR"

**1. Set the year**

Make sure the cursor is located on the year area.

Push "←" or "→" button to set the year. The year can be set from 2000 to 2999.

After setting, push the "R" button to move the cursor to the month area.

If push the "MODE" button, the normal screen is displayed.

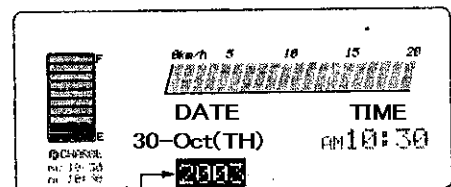

SET "YEAR" BY ←→ BUTTON

## 2. Set the month

Make sure the cursor is located on the month area.

Push " $\triangleleft$ " or " $\triangleright$ " button to set the month. the month can be selected from 1 to 12.

After setting, push " $\text{R}$ " button for the date setting.

If pushing " $\text{MODE}$ " button, the cursor is returned to the year area.

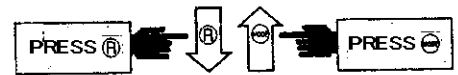
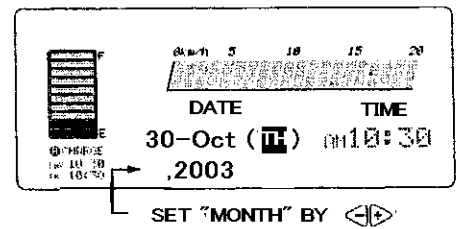

## 3. Set the date

Make sure the cursor is located on the date area.

push " $\triangleleft$ " or " $\triangleright$ " button to set the date. The date can be set from 1 to 31. When setting the date, the day of the week is set automatically.

After setting, push the " $\text{R}$ " button to move the cursor to the AM/PM area.

If pushing " $\text{MODE}$ " button, the cursor is returned to the month area.

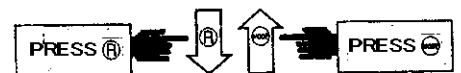
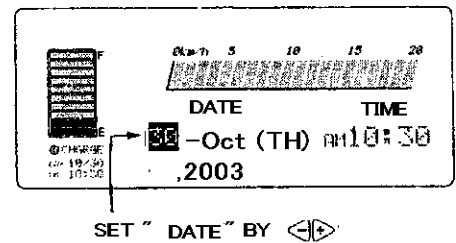

## 4. Set the AM or PM

Push the " $\triangleleft$ " or " $\triangleright$ " button to select the AM or PM.

After setting, push the " $\text{R}$ " button to move the cursor to the hour area.

If pushing " $\text{MODE}$ " button, the cursor is returned to the data area.

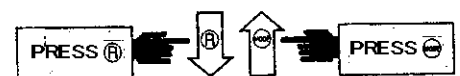
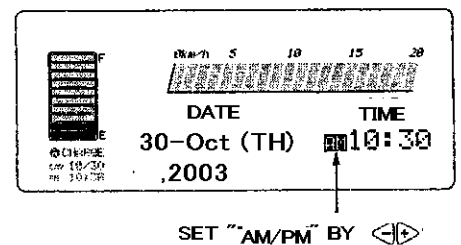

## 5. Set the hour

Push the " $\triangleleft$ " or " $\triangleright$ " button to set the hour. The hour can be set from 1 to 12.

After setting, push the " $\text{R}$ " button to move the cursor to the minute area.

If pushing " $\text{MODE}$ " button, the cursor is returned to the AM or PM area.

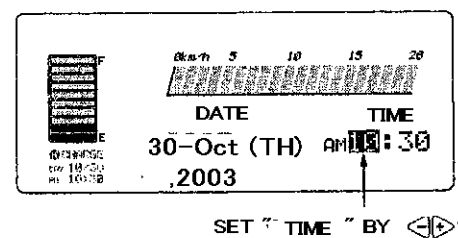



### 3 EACH PART NAME AND FUNCTION

#### 6. Set the minute

Push the " $\leftarrow$ " or " $\rightarrow$ " button to set the minute. The minute can be set from 00 to 59.

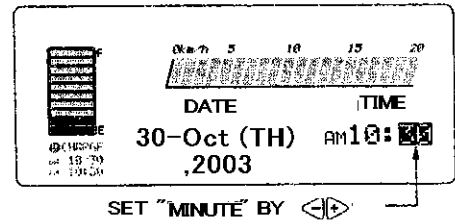

After setting, push the " $\textcircled{R}$ " button.  
Then "COMPLETE" message is flashed three times.  
In any cases, push " $\textcircled{\text{MODE}}$ " button to get the previous step.

#### CAUTION

- When pushing the " $\leftarrow$ " or " $\rightarrow$ " button, the second is set to "00".
- After setting the minute and push the " $\textcircled{R}$ " button, the second is set to "00".
- If set the date and time, the reserve charge setting is also renewed.

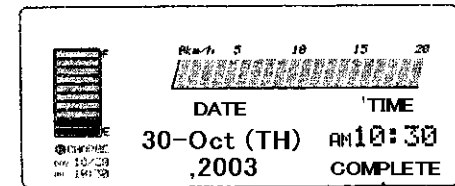

"COMPLETE" is displayed 3times with blinling

BASIC SCREEN

# 4 MOTOR

## 4-1. POSITION AND EACH PART NAME

### 4-1-1. THE PARTS NAME OF DRIVE MOTOR

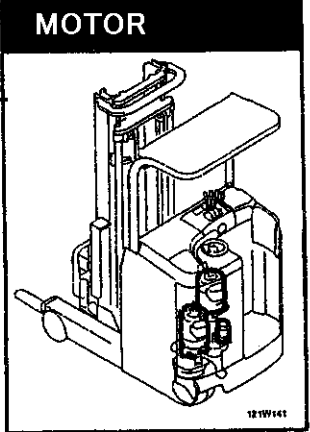
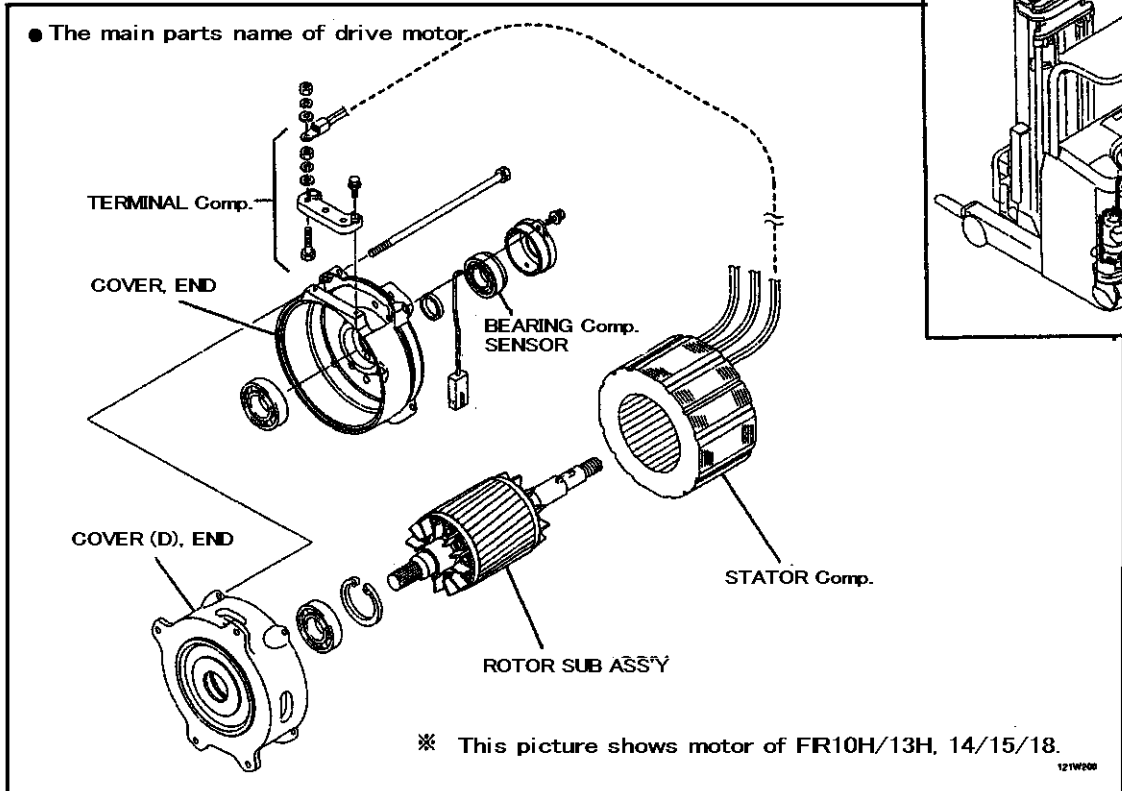

### 4-1-2. THE PARTS NAME OF PUMP MOTOR

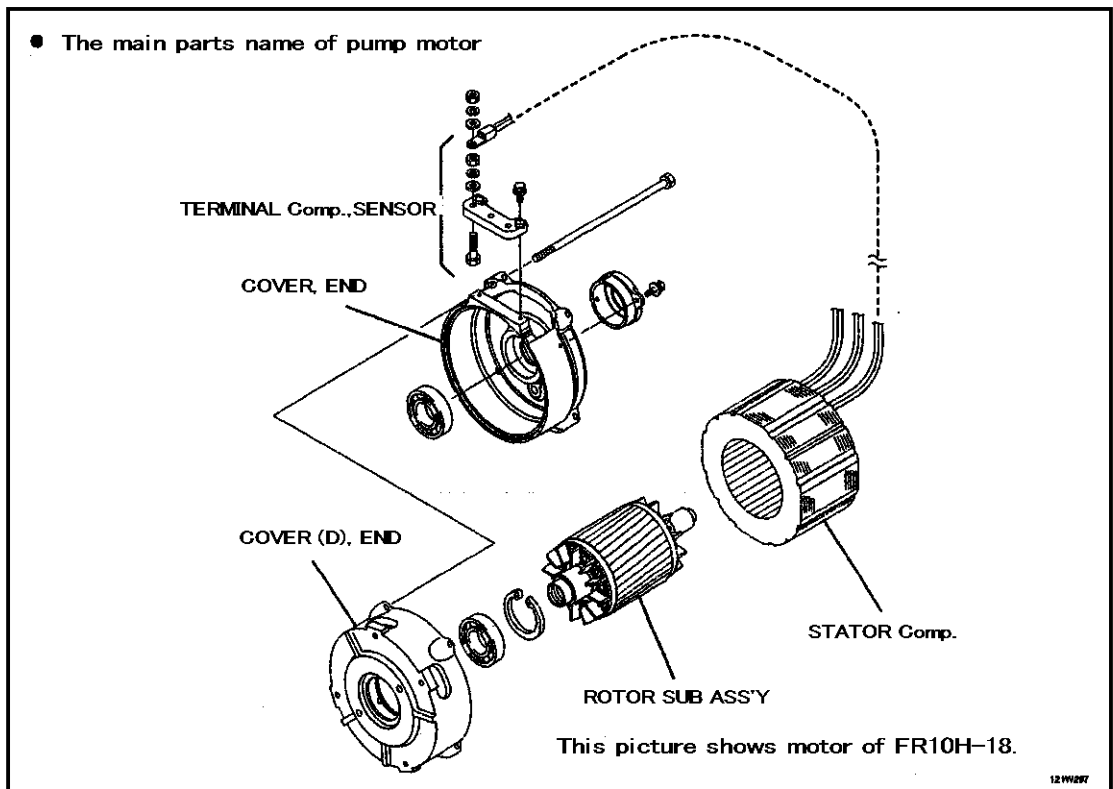



**4-1-3. THE PARTS NAME OF EPS MOTOR**

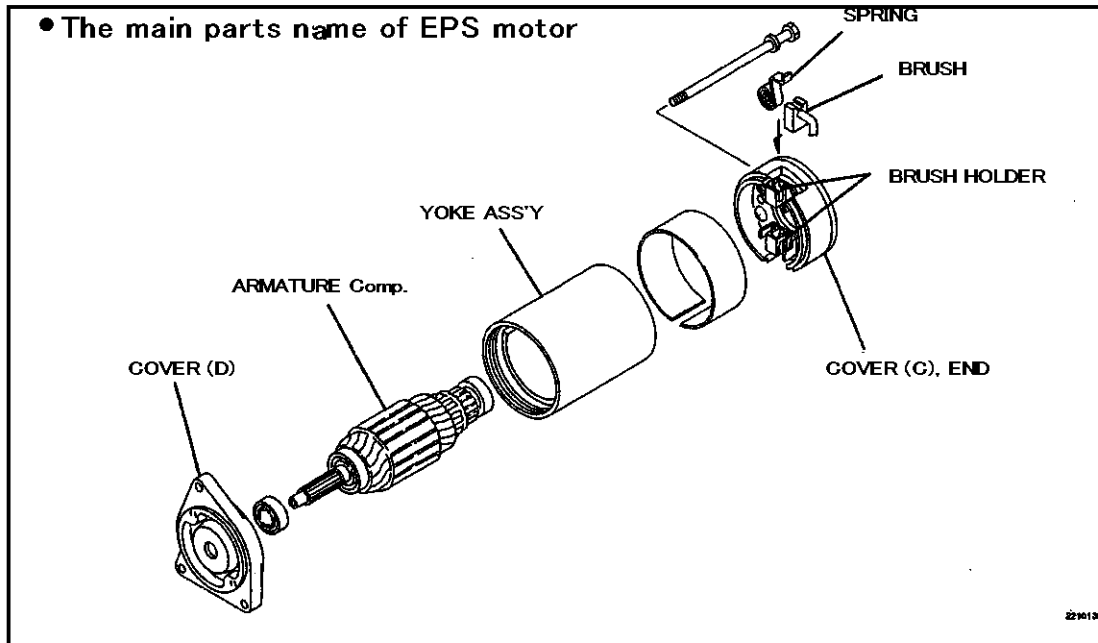

**4-1-4. THE SPECIFICATION OF MOTOR**

• DRIVE MOTOR

APPLICABLE MODEL	TYPE	NOTE
FR10/13	AT26A1	2.6 kW, 15 V, 60 min
FR10H/13H,14/15/18	AT43B2	4.3 kW, 30 V, 60 min
FR20/25	AT50C2	5.0 kW, 30 V, 60 min

• PUMP MOTOR

APPLICABLE MODEL	TYPE	NOTE
FR10/13	AH60A1D	6.0 kW, 15 V, 10 min
FR10H/13H,14/15/18	AH88B2D	8.8kW, 30V, 10min
FR20/25	AH110B2D	11.0 kW, 30 V, 10 min

• EPS MOTOR

APPLICABLE MODEL	P/N	NOTE
FR10/13	37410-01310	0.15 kW, DC24 V (0.3 kW, DC48 V)
	37410-01460	0.15 kW, DC24 V
FR10H/13H, 14-25	37410-00990	0.3 kW, DC48 V
	37410-01280	0.3 kW, DC49 V
	37410-01470	0.3 kW, DC48 V

# 5 CONTROL PANEL

## 5-1. RESOLUTION AND ASSEMBLE

### 5-1-1. RESOLUTION AND ASSEMBLE OF THE CONTROL PANEL

**CAUTION**

- Record connected position when you remove the lead line.
- Pull out the battery plug.

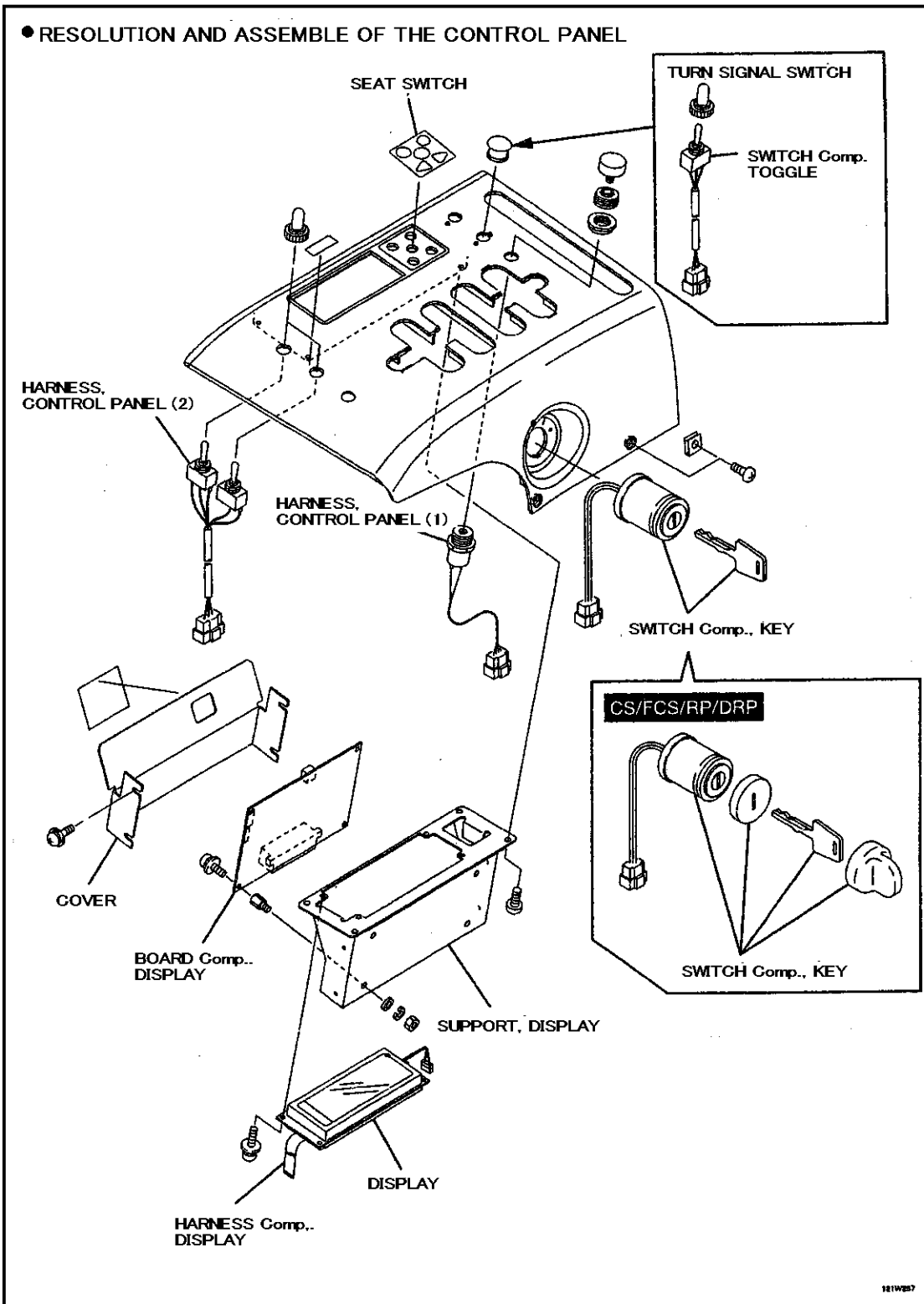



5-1-2. CAUTION OF ASSEMBLING

- Use the turn prevention hole on reverse side of panel reinstall the each switch.(However, exclude the horn switch.)

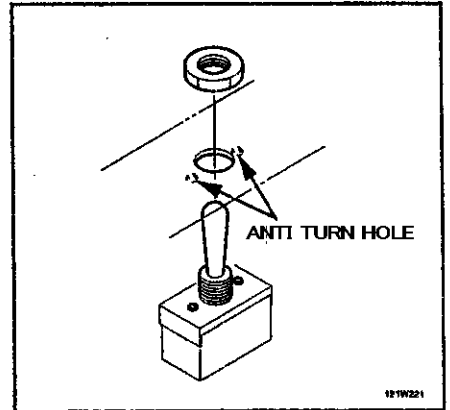

- The harness in the control panel does not come into right side of panel within 40mm.

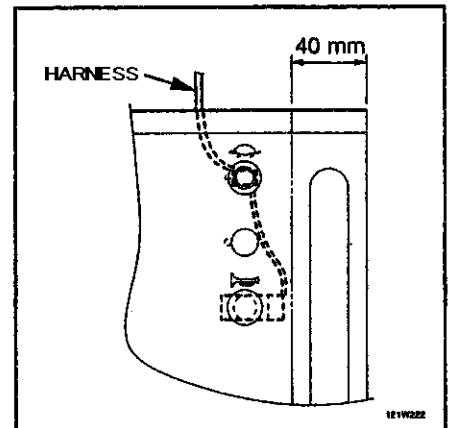

# 6 ACCELERATOR

## 6-1. RESOLUTION AND ASSEMBLE



Pull out the battery plug before it works.

### 6-1-1. RESOLUTION AND ASSEMBLE OF THE ACCELERATOR

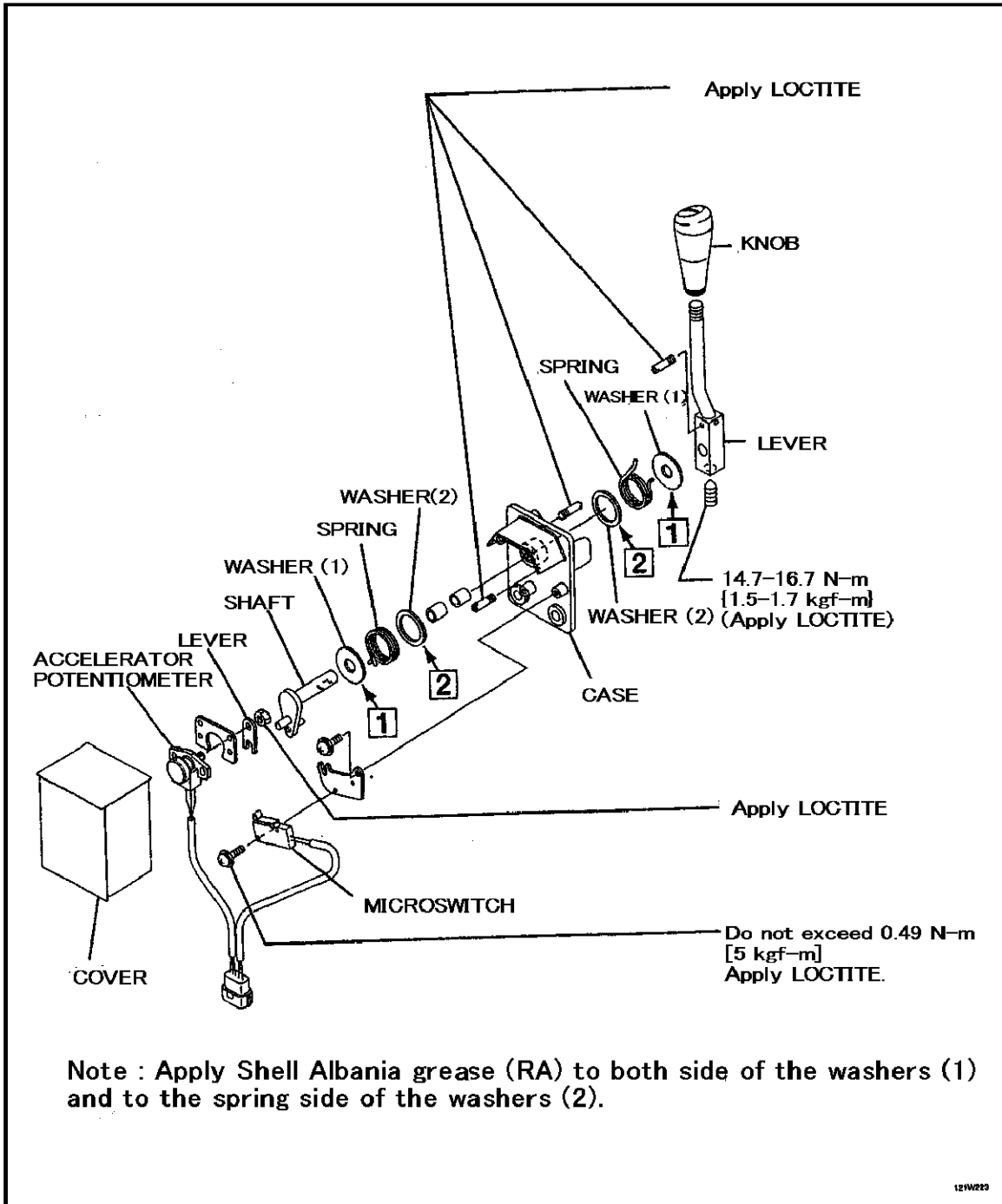



**6-1-2. INSTALL LEVER**

- Match the direction of the sign (\*) and the lever that exists in the shaft of Potentiometer as shown in the figure below.

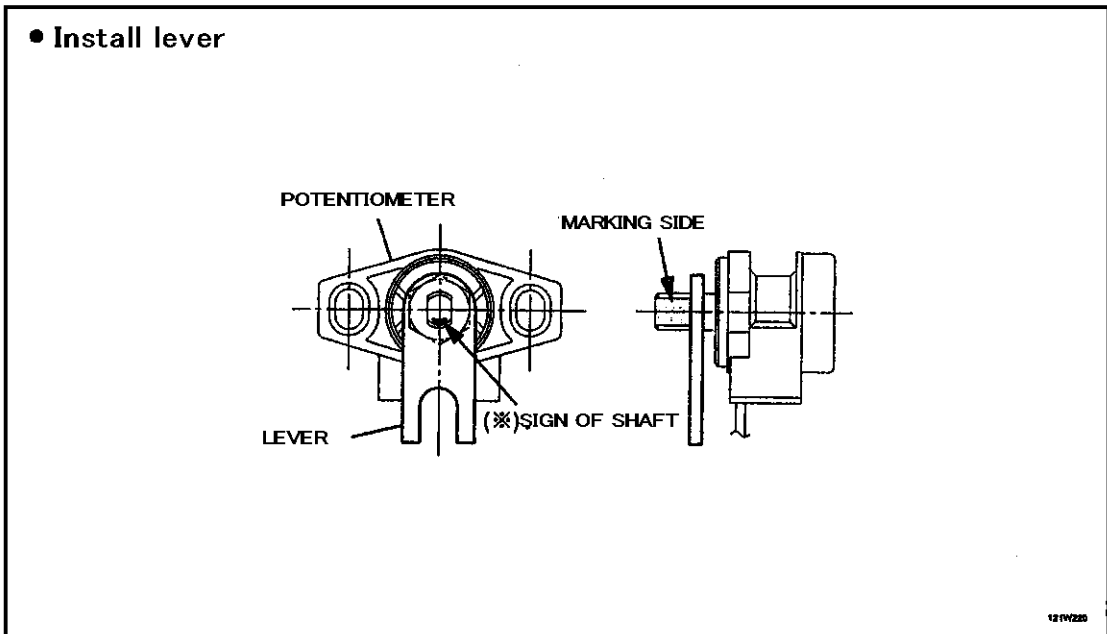

**6-1-3. ADJUST POTENTIOMETER**

- Refer to the chapter of the TROUBLE SHOOTING for the adjustment of the potentiometer.

# 7 MAIN CONTACTOR AND FUSE

## 7-1. RESOLUTION AND ASSEMBLE



- Record connected position when you remove the lead line.
- Pull out the battery plug.

### 7-1-1. REPLACING, REINSTALLING MAIN CONTACTOR AND FUSE

1. Remove the roulett knob and remove the front cover.

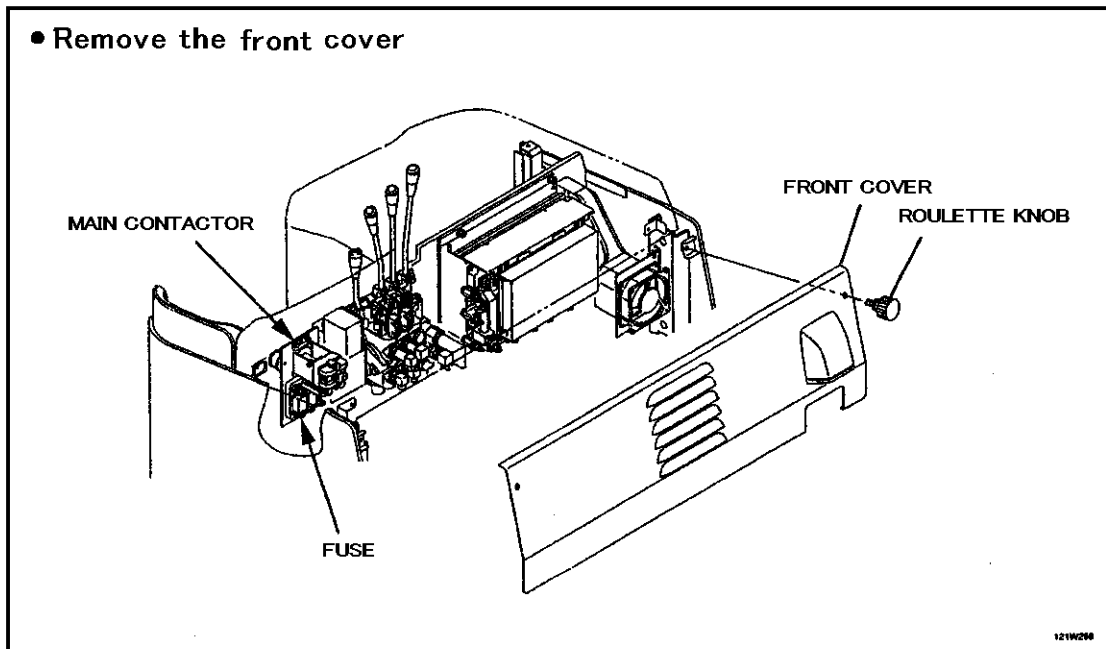



**2. Remove the main contactor and fuse.**

- ① Remove the main contactor and lead line for the wiring.
- ② Referring to the figure below and remove main contactor and fuse.

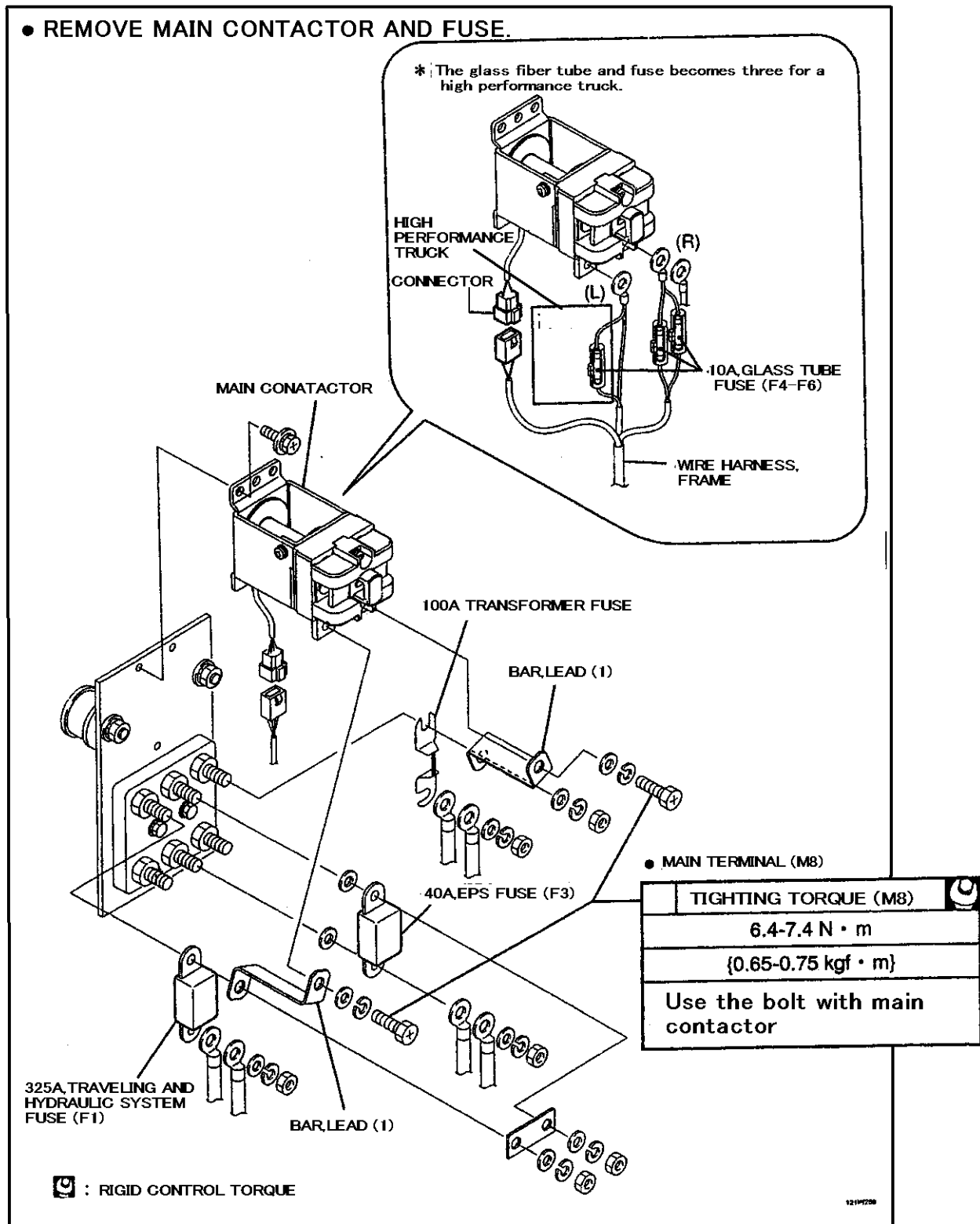

※ Install main contactor and fuse in the reverse order of detaching.

# 7-2. CHECK AND EXCHANGE

**CAUTION**

- Record connecter position when you remove the lead line.
- Pull out the battery plug.

## 7-2-1. CHECK AND EXCHANGE MAIN CONTACTOR

- ① Check contact areas for excessive wear or burns, and if any defect is found, replace the main contact assembly with a new one.

**CAUTION**

The main contactor assembly must be replaced with a new one every two year, even if it appears normal.

● TYPE OF MAINCONTACTOR

APPLICABLE MODEL	MANUFACTURE'S TYPE	VOLTAGE
FR10H/13H FR14-30	HR-15P4A	48V

- ② Apply the tightening torque in a right picture about main terminal (M8).

● CHECKING MAIN CONTACTOR

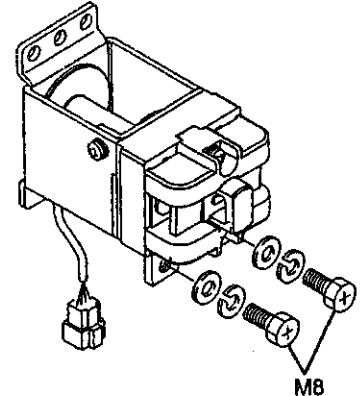

● MAIN TERMINAL (M8)

TIGHTENING TORQUE (M8)
6.4-7.4 N · m
{0.65-0.75 kgf · m}

: TIGHTENING TORQUE

## 6d-2-2. Replacing fuse

When replacement of any fuse is required, use a new fuse of the same capacity and tighten the mounting nut securely

Use	Capacity	
Traveling	F1	325 A
EPS	F2	40 A
Transformer		100 A
Control unit	F3	10 A
Electromagnetic brake	F4	10 A
Accessories	F5	10 A

● TYPE OF FUSE

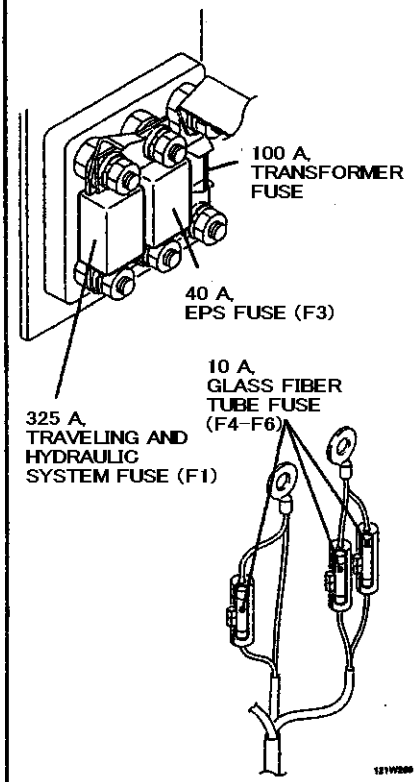

※ The glass fiber tube increases 3.(High performance truck)

# 8

## FAN

### 8-1. RESOLUTION AND ASSEMBLE

#### 8-1-1. REMOVE AND INSTALL FAN

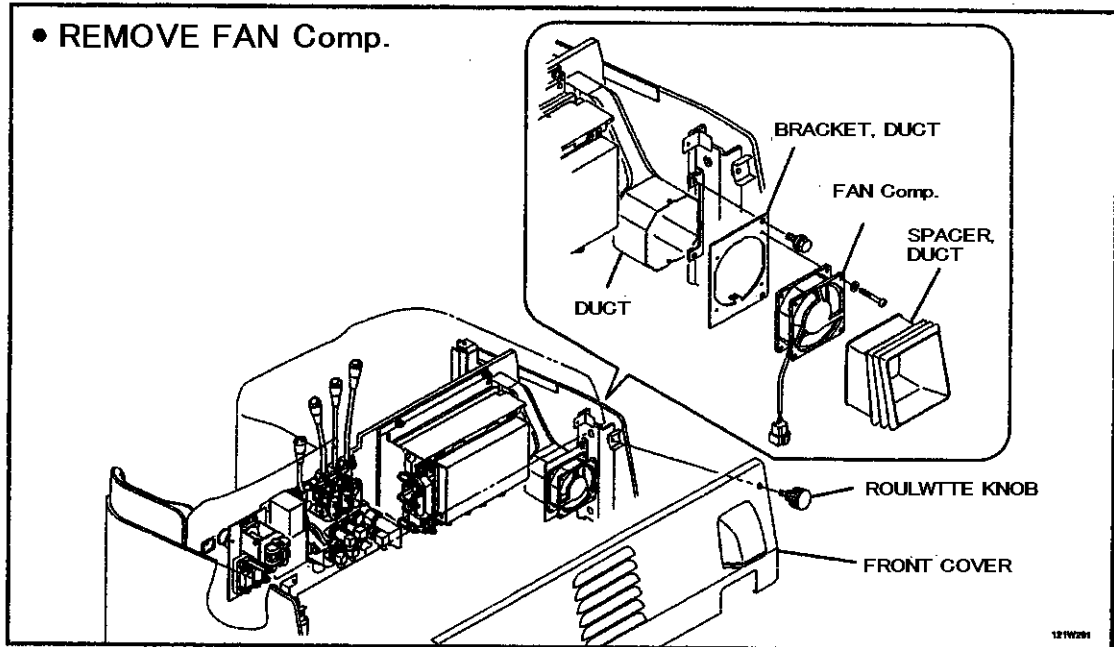

# 9

## STEERING ANGLE POTENTIOMETER

### 9-1. RESOLUTION AND ASSEMBLE

#### 9-1-1. REMOVE AND INSTALL POTENTIOMETER

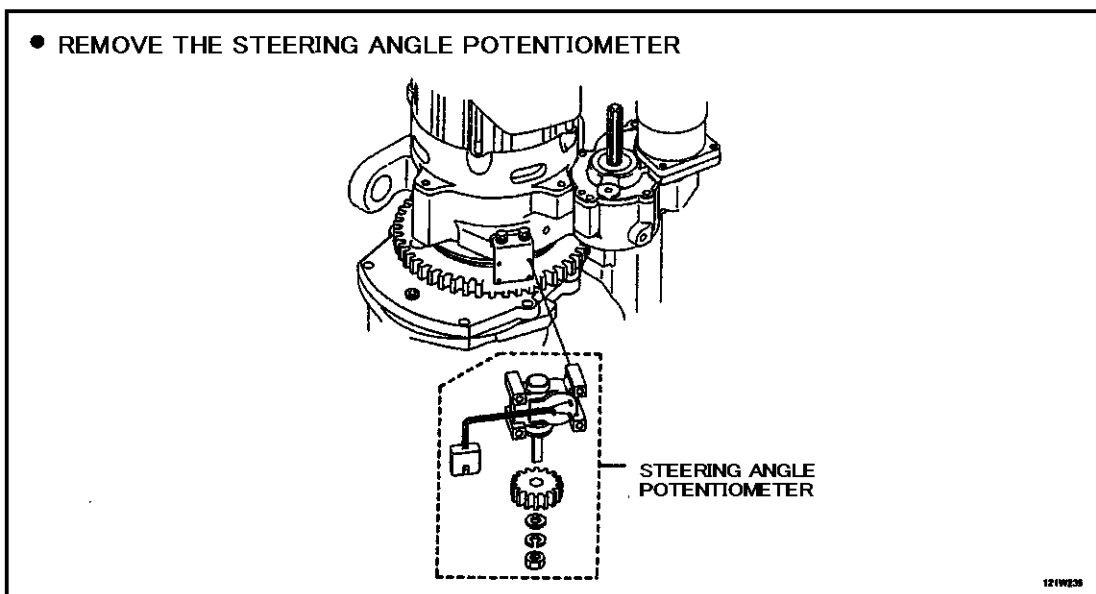

#### 9-1-2. ADJUST POTENTIOMETER

- Refer the chapter of the trouble shooting for the adjustment of potentiometer.



# **TROUBLE SHOOTING GUIDE**

# 10 ADJUSTMENT FOR CONTROLLER

## 10-1. EXPLANATION OF MPU BOARD

### 10-1-1. BASIC CONTROL BOARD CONSTRUCTION

As shown in the figure below, the SICOS-AC uses the display board as the central point for connecting all other boards for the exchange of data. In addition, all control boards use a one-chip CPU (with flash ROM) as their main CPUs, so their ROM can not be removed.

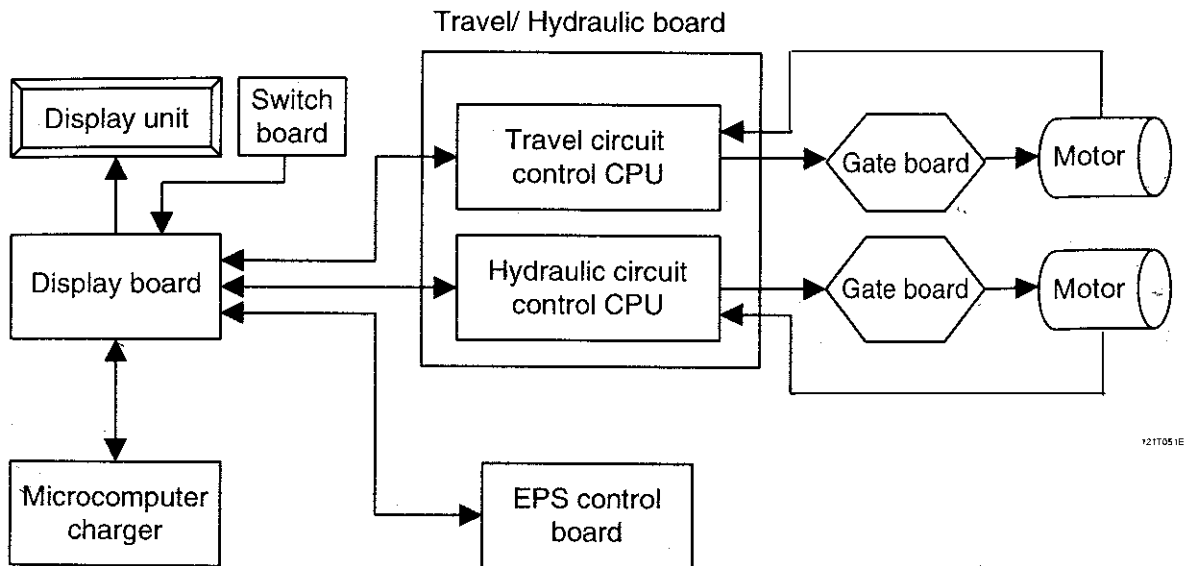

**10-1-2. TRAVEL, HYDRAULIC BOARD**

<Type : PB103-XXX>

- This board controls the traction motor and the hydraulic motor.

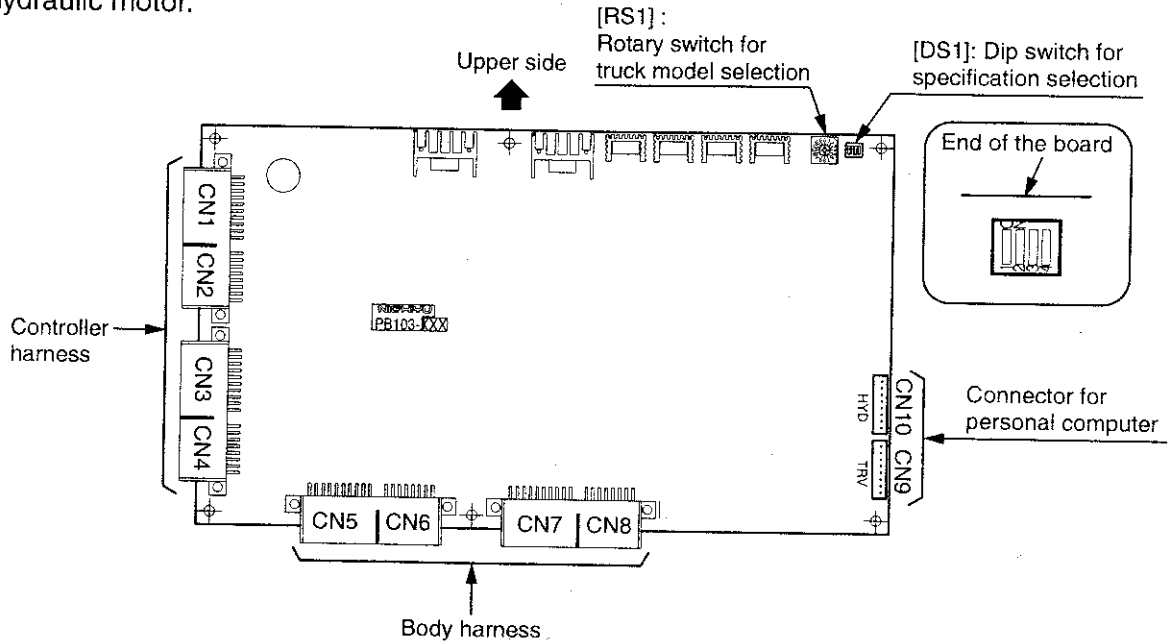

**10-1-3. DISPLAY BOARD**

<Type : PB103-XXX>

- This board controls both the data exchanged between the other boards and the display.

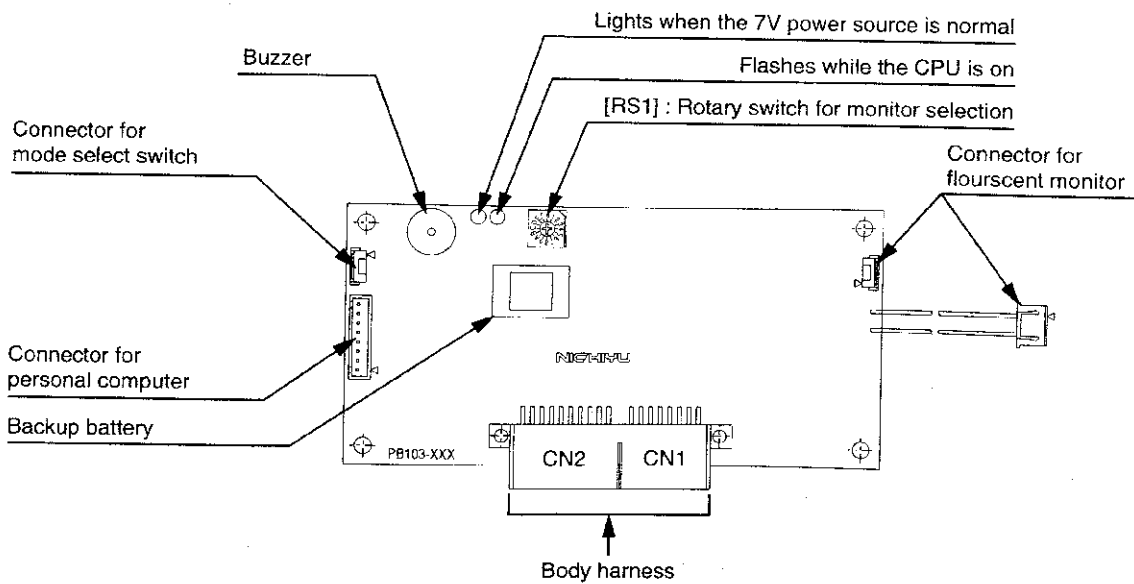

The voltage of the battery apply the display board. Disconnect the battery plug before working.

1211740L



**10-1-4. ROTARY SWITCH LIST OF TRAVEL, HYDRAULIC BOARD**

The rotary switch[RS1] of travel & hydraulic board is used to select the truck model. When you change the board, match the truck model in following chart.

● RS1 setting list

RS1	DISPLAYING MODEL ON METER PANEL		APPLICABLE MODEL(TCM)				4WAY		NOTE
			STD		HIGH MAST		DISPLAYING MODEL ON METER PANEL	APPLICABLE MODEL (TCM)	
0	R9-H						R9		24V1.
1	RA9-H						RA9		
	R10-H						R10		
2	R13-H	RA13-H					R13	RA13	
3	R14-H						R14		
4	RA14-H		FR14-7	82K	FR14-7H	82L	RA14		
	R15-H		FR15-7	82M			R15	FR15-7M	79M
5	RA15-H				FR15-7H	82N	RA15		
	R18-H	RA18-H	FR18-7	82P	FR18-7H	82Q	R18	RA18	
6	R20-H						R20		
7	RA20-H		FR20-7	82R			RA20	FR20-7M	79N
8	R25-H						R25		
								FR25-7M	79P
A	R30-H		FR30-7	79K	FR30-7H	79L	R30		
B	RA30-H						RA30		
C	R10H-H		FR10-7C	82A			R10H		
			FR10-7	82F					
			FR9-7L	82W					
D	RA10H-H		FR10-7L	82X	FR10-7CH	82B	RA10H		
	R13H-H	RA13H-H	FR13-7C	82C	FR13-7CH	82E	R13H	RA13H	
			FR13-7L	82Y	FR10-7H	82G			
			FR13-7	82H	FR13-7H	82J			
E									
F									

• Model display on the meter panel is available to push "R" of the switch board for long time.

**1-1-5. DIP SWITCH LIST OF TRAVEL, HYDRAULIC BOARD**

The Dip Switch [DS1] is used for the spec selection. Please refer to the chart below when you replace the travel, hydraulic board.

● SPEC DS1 SETTING LIST

DS1	SETTING	CONTENTS	
1	HIGH FUNCTION MODE	OFF : STANDARD	ON : HIGH FUNCTION TRUCK MODE
2	SPEC W	OFF : EXCEPT SPEC W	ON : SPEC W
3	DATA OF DIAMETER	OFF : NORMAL	ON : COMPUSSION SELF ADJUST TO DATA OF TIRE DIAMETER
4	SUS LOCK	OFF : NORMAL	ON : WITHOUT SUS LOCK

\*) Spec W of FBR10H - 13H set the DS1-2 (SPEC W) to "ON". (HIGH FUNCTION TRUCK)

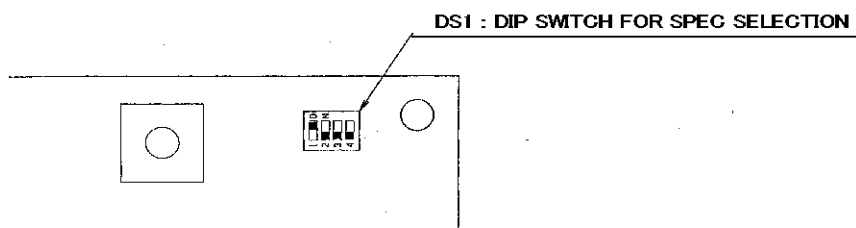

**10-1-6. ROTARY SWITCH LIST OF DISPLAY BOARD**

The rotary switch [RS1] on the display board is used to select the display and the adjustment shown in the following table.

## RS1 FUNCTION LIST

RS1	FUNCTION	NOTE
0	Monitoring OK	Displayed at a key switch on
	Usual monitor	Battery capacity, Speed, Hour meter, Error, Clock, Reserve charge
	Making sure hour meter	Displaying hour meter for total, travel, and
	Charge reservation screen	Specify starting charge
	Correction for date, time	Correcting date, time
	Low-speed set up	Speed setting at turtle switch on
	Power mode set up	Setting economy, normal, or powerful
	Change-over hour meter, distance	Setting change-over switching hour meter, distance of usual monitor
	Brightness control of VFD	BRIGHTNESS level (0-7)
	Adjustment for neutral regenerative force at neutral (Accel.off)	4 levels including OFF
	Others for making sure service set up	Making sure truck model, soft ware number, buzzer mode, rotarySW mode setting
1	Symbol set up	Screen character, TRAVEL, HYD, STEER, BRAKE, OIL, LOAD
2	Displaying truck model	Displaying truck model of travel, hydraulic board set
3	Plugging force set up	0-32
	Pbrake force set up	0-32
	Anti-slip set up	NON LOW MID HIGH
4	Lift limit of Low-speed travel	0-32(HIGH SPEED) : 0-4km/h
	Lift limit of Mid-speed travel	0-32(HIGH SPEED) : 4-8km/h
	Lift limit of High-speed travel	0-32(HIGH SPEED) : 8km/h
	Lift 1 speed	0-32(HIGH SPEED) : Micro 1st step
	Lift 2 speed	0-32(HIGH SPEED) : Micro 2nd step
	Tilt speed	0-32(HIGH SPEED)
	Reach speed	0-33(HIGH SPEED)
	Attachment 1 speed	0-34(HIGH SPEED)
Attachment 2 speed	0-35(HIGH SPEED)	
5	Switch displaying language	6 foreign languages
6	Option set up	Set up option
7	Displaying voltage, current, temperature	
8	Displaying RAM&I/O data	
9	Error history memory 1	Displaying latest 10 cases
	Error history memory 2	All errors that occurred in the past are recorded
A	Battery voltage set up	Set up the voltage in capacity meter standard
B	Speed limit at turning	0-16
C	AOS set up 1	Set up lift end, tilt end, and Others
D	AOS set up 2	Checking leverSW
E	Memory initial	Clearing error history
F	Standard screen 2	No error display on the screen of RS0, Displaying hour meter when happening the error.

10-1-7. OTHERS, FOR MAKING SURE SERVICE SET UP

SETTING SCREEN

<HOW TO CONFIRM>

When you keep pushing the (R) button for three seconds or more, the following screen is displayed.

● SCREEN FOR MAING SURE TRUCK MODEL

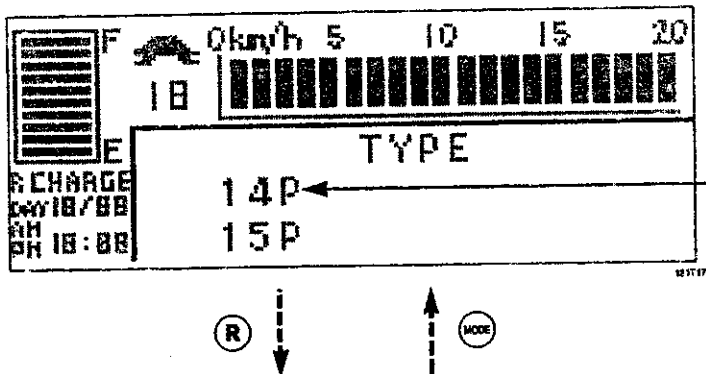

The model that made set up it with the travel & hydraulic board by RS1 switch is displayed.

● SCREEN FOR MAKING SOFTWARE NUMBER

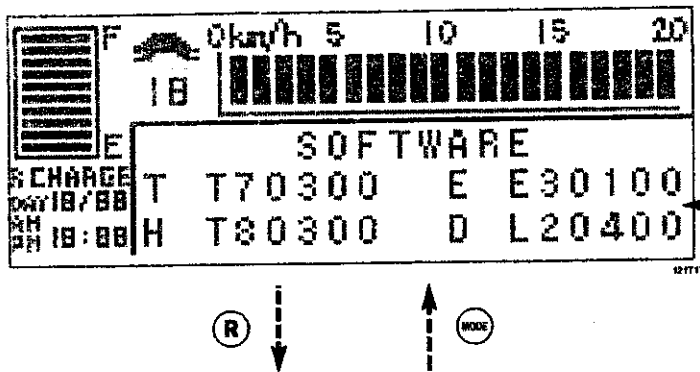

Displaying the software number for T(Travel), H(Hydraulic), E(EPS), D(Display).

● SCREEN FOR BUZZER MODE/ROTARY SW MODE/ SET UP MODE SETTING

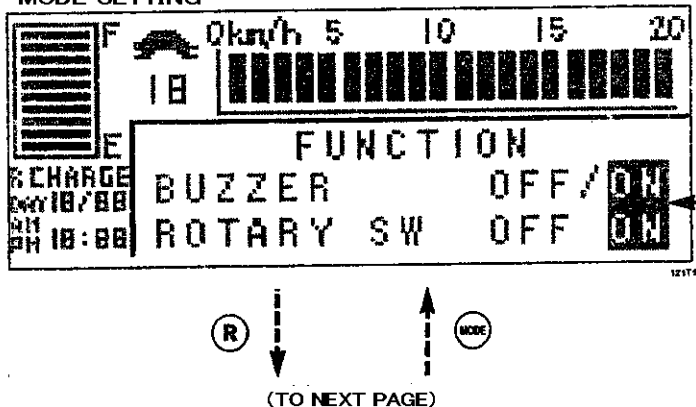

Blinking buzzer mode set up

- The buzzer mode is set pushing (right arrow) or (left arrow). (OFF /ON)
- ON : Standard
- OFF : Mute the buzzer other than winker
- The rotary SW mode setup is reversed and displayed.

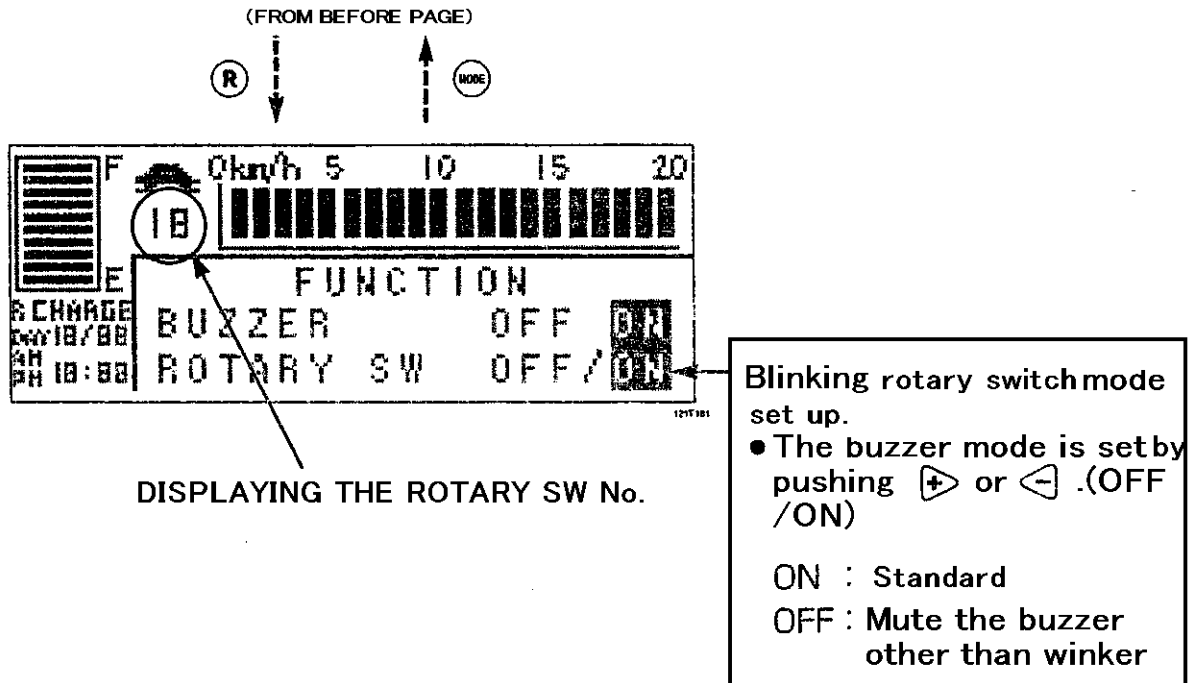

**CAUTION**

- When it's not possible to communicate with the travel & hydraulic and EPS board, the soft number is not displayed.
- All the buzzer sounds mute when the buzzer mode is turned off. (Excluded sound of winker lamp blinking)
- When turning the buzzer off, the rotary switch on the board becomes invalid. And the rotary can be rotated in software by pushing both  $\text{MODE}$  and  $\blacktriangleright$  button or  $\blacktriangleleft$  button for 3 seconds or more at the same time.



## 10-2. MAKING SURE AND ADJUSTING CONTROLLER

**CAUTION**

- Even if turning the key switch off, the battery voltage is applied to the display board. Disconnect the battery plug before working.
- After completed set up, return RS1 switch to "0" position.
- In case of measuring the connect, measure the motor current by putting AC mode and the battery connect by putting DC mode

• DISPLAY BOARD



After completed set up return RS1 to "0" position.

### 10-2-1. MAKING SURE THE CHASSIS INSULATION

<How to confirm>

- ① Disconnect the battery plug.
- ② Disconnect connector (green black) of detecting battery electrolyte level line in the control unit.
- ③ Measure the insulation resistance each case between "chassis body side battery plug [+]" and the chassis" and between "chassis body side battery plug [-]" and the chassis".

NOTE : Measurement should be performed after discharging condenser.

STANDARD VALUE	1MΩ or more
----------------	-------------

## 10-2-2. ADJUSTING BATTERY VOLTAGE

### <MEASURING POINT>

- Pull the battery out, disconnect the plug.  
Measure the battery voltage at the main terminal direct from the battery line appeared.  
It automatically changes on the display for 24V and for 48V by the model set up.

### <MEASURING CONDITION>

Specific gravity : 1.25 or more (20°C)  
of battery fluid

### <MEASUREMENT METER>

Use the digital tester that can measure 1/100V.  
DC (Direct Current) mode

### <HOW TO ADJUST>

- ① Set up the rotary switch RS1 on display board "A".

#### ● DISPLAY BOARD

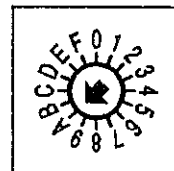

SET UP RS1 TO "A"

- ② When turning the key switch on, the following screen is displayed.

- Adjusting battery voltage screen

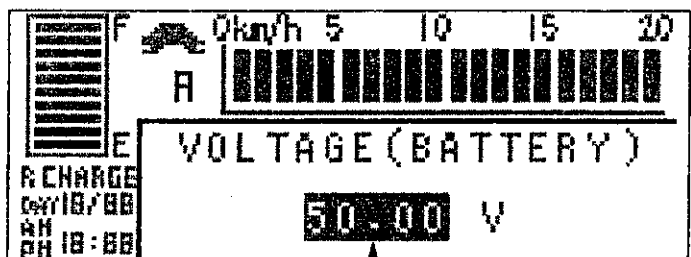

SET VALUE OF BATTERY VOLTAGE( BLINKING)

- ③ Set up the battery voltage as well as the measured value.

#### NOTE

Set it up within  $\pm 0.1V$  or less.

- Set value increases when you push the  $\rightarrow$  .
- Set value decreases when you push the  $\leftarrow$  .

10-2-3. MAKING SURE CURRENT DETECTOR

MAKING SURE DRIVE MOTOR CURRENT (UNLOADED, LOCK)

<MEASURING POINT>

I<sub>U</sub> : Drive motor current for U-phase (Even the V-phase or W-phase is acceptable)

<MEASURING CONDITION>

Specific gravity of : 1.25 or more (20°C)  
battery electrolyte

<MEASURING TOOL>

Clamp ammeter

AC (Alternating current) mode

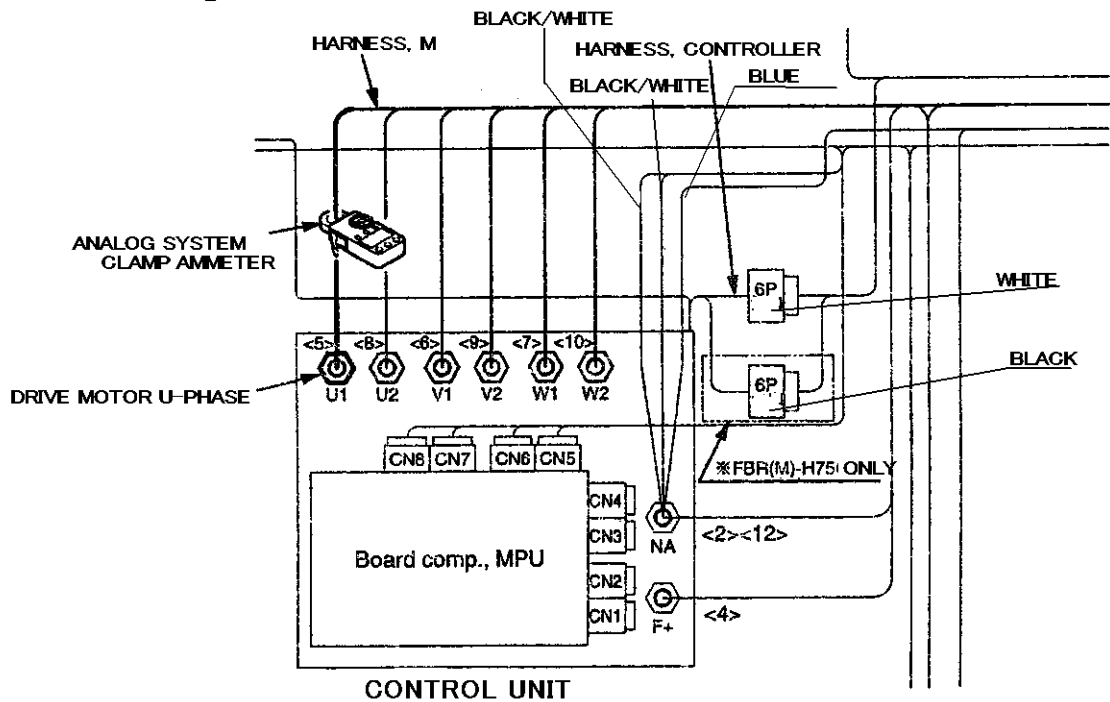

1047-002

<HOW TO CONFIRM>

- ① Set up the rotary switch RS1 on display board to "7".
- ② When turning the key switch on, the following screen is displayed.

• DISPLAY BOARD

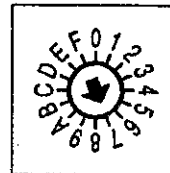

SET UP RS1 TO "7"

**NOTE**

When the TRV doesn't blink, let blink "TRV" the before press the ◀ button.

• SCREEN OF VOLTAGE, CURRENT, TEMPERATURE CONFIRMATION

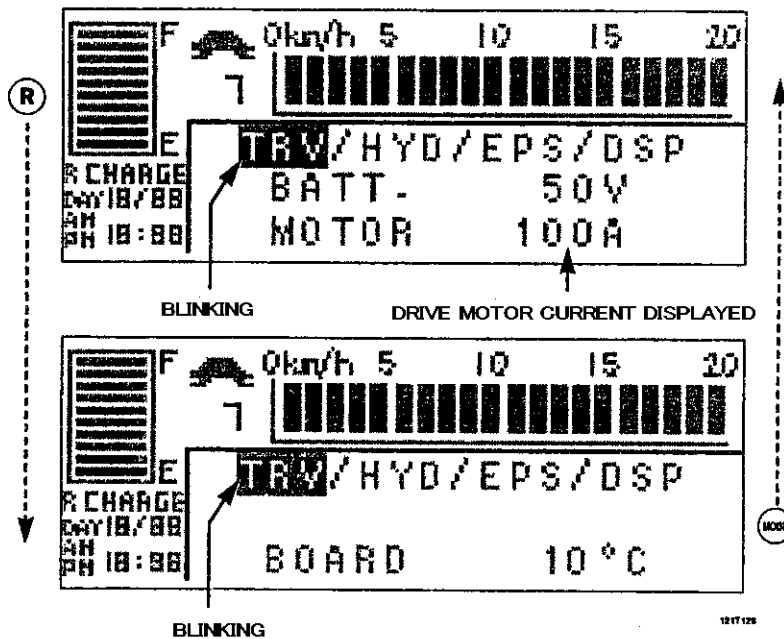

- ③ At the state of no current flow, make sure to display for the drive motor current (MOTOR) is 000A.
- ④ Jack up the drive wheels then perform the following.

In case of unloaded current

Keep rotating the wheels at full acceleration.

In case of the lock current

Release the brake pedal, with the brake micro on, make strong the brake spring (as stop rotation) and being accelerated.

**WARNING**

When measuring, jack up drive wheel.

- ⑤ Make sure the drive motor current (IU) displays to be allowable  $\pm 20A$  in the meter reading (MOTOR).

## MAKING SURE HYDRAULIC CURRENT

### <MEASURING POINT>

I<sub>U</sub> :Hydraulic motor current for U-phase (Even the V-phase or W-phase is acceptable)

### <MEASURING CONDITION>

Specific gravity of : 1.25 or more (20°C)  
battery electrolyte

### <MEASURING TOOL>

Clamp ammeter  
AC (Alternating current) mode

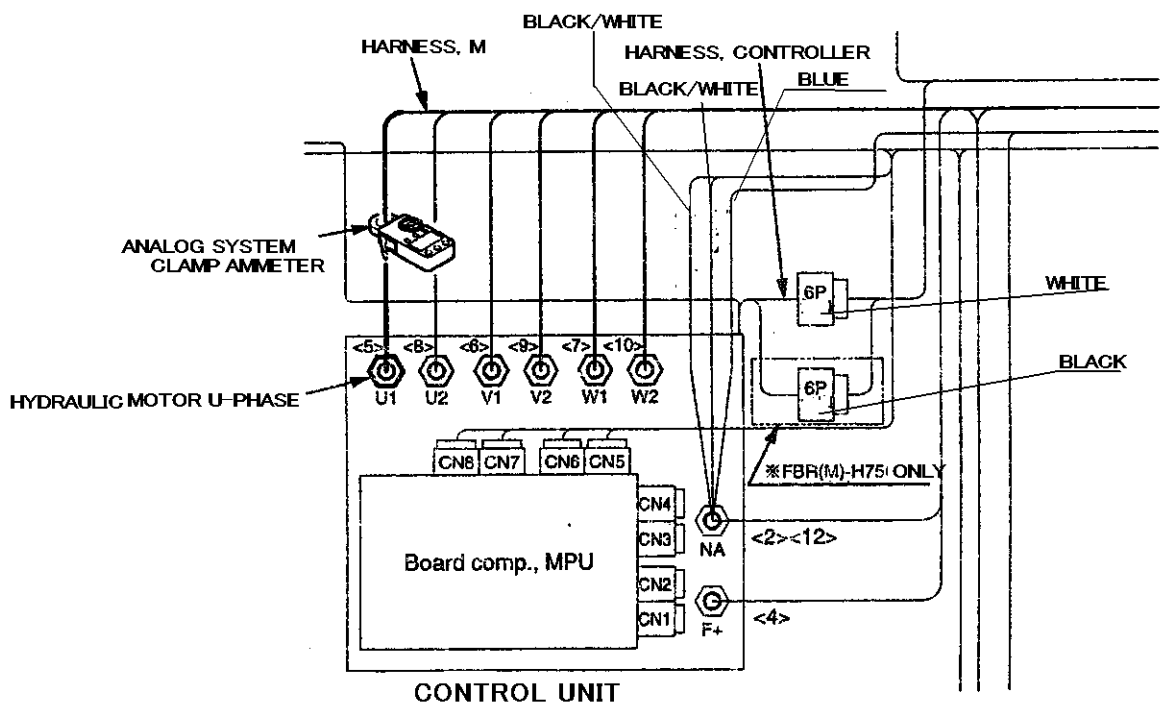

121102



## &lt;HOW TO CONFIRM&gt;

- ① Set up the rotary switch RS1 on display board to "7".
- ② When turning key switch on, the following screen displayed.
- ③ Press either  $\rightarrow$  or  $\leftarrow$ , and let to blink the "HYD".

## ● DISPLAY BOARD

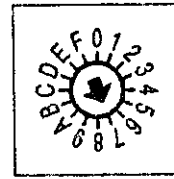

SET THE RS1 TO "7".

## ● SCREEN OF VOLTAGE, CURRENT TEMPERATURE CONFIRMATION

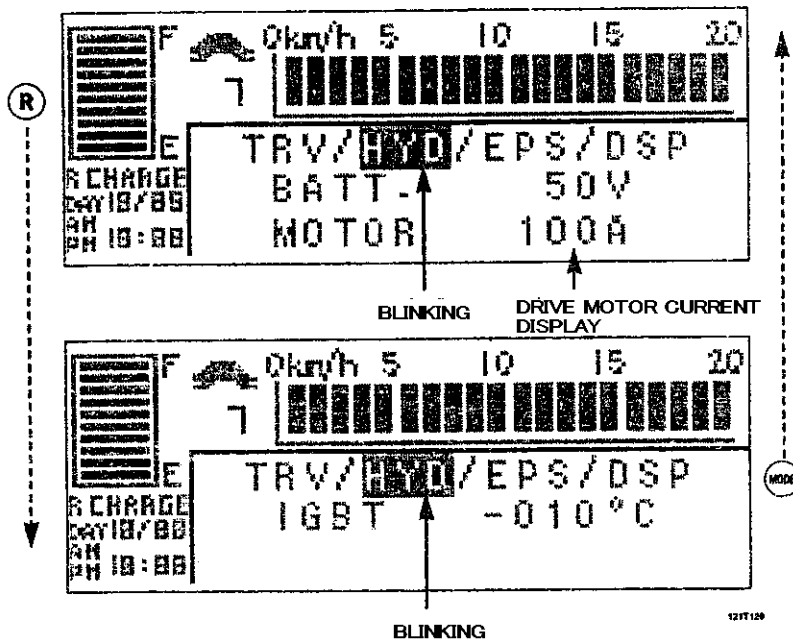

- ④ At the state of no current flow, make sure to display for the hydraulic motor (MOTOR) is 000A.
- ⑤ Keep the lifting is in relief.
- ⑥ Make sure the hydraulic motor current (IU) displays to be allowable  $\pm 20A$  in the meter reading (MOTOR).

**10-2-4. MAKING SURE AND ADJUSTING TRUCK MODEL SET UP**

<HOW TO MAKE SURE 1>

- ① Set up rotary switch RS1 on display board to "2".
- ② When turning the key switch on, the following screen is displayed.
- ③ Make sure correct the truck model is set up.

● DISPLAY BOARD

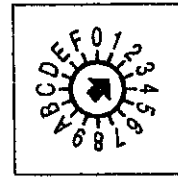

SET UP RS1 TO "2".

<HOW TO CONFIRM 2>

- ① Press **(R)** button on the display for 5seconds.
- ② The following screen is displayed.
- ③ Make sure the truck model.
- ④ After making it sure, press the **(R)** button again.

● SCREEN FOR MAKING SURE TRUCK MODEL

(When the rotary switch RS1 on the travel & hydraulic board is set to "2".)

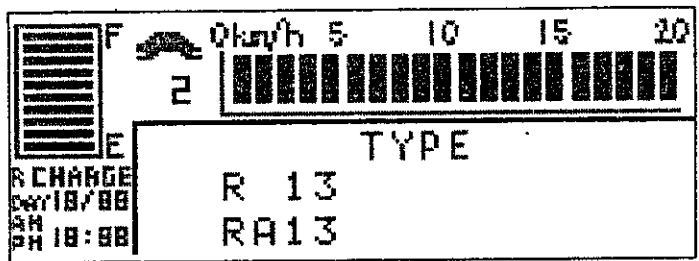

● TRAVEL & HYDRAULIC BOARD

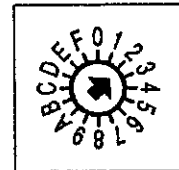

RS1 = "2"

## &lt;HOW TO ADJUST&gt;

① SET UP TRUCK MODEL : Set the truck model by rotary switch on the travel & hydraulic board.

● RS1LIST (travel & hydraulic board)

RS1	メータパネルの 機種表示		適用機種(TCM)			
			標準車		高揚高	
0	R9-H					
1	RA9-H					
	R10-H					
2	R13-H	RA13-H				
3	R14-H					
4	RA14-H		FR14-7	82K	FR14-7H	82L
	R15-H		FR15-7	82M		
5	RA15-H				FR15-7H	82N
	R18-H	RA18-H	FR18-7	82P	FR18-7H	82Q
6	R20-H					
7	RA20-H		FR20-7	82R		
8	R25-H					
9	RA25-H		FR25-7	82T	FR20-7H	82S
					FR25-7H	82U
A	R30-H		FR30-7	79K	FR30-7H	79L
B	RA30-H					
C	R10H-H		FR10-7C	82A		
			FR10-7	82F		
			FR9-7L	82W		
D	RA10H-H		FR10-7L	82X	FR10-7CH	82B
	R13H-H	RA13H-H	FR13-7C	82C	FR13-7CH	82E
			FR13-7L	82Y	FR10-7H	82G
			FR13-7	82H	FR13-7H	82J
E						
F						

**10-2-5. SAFETY CIRCUIT FOR CONTROL (CONTACTOR TRIPPING) CHECK**

**<CHECKING PROCEDURE>**

1. Turn the key switch to OFF, and disconnect the battery plug.
2. Disconnect connectors of travel/hydraulic board (CN2 and CN4).

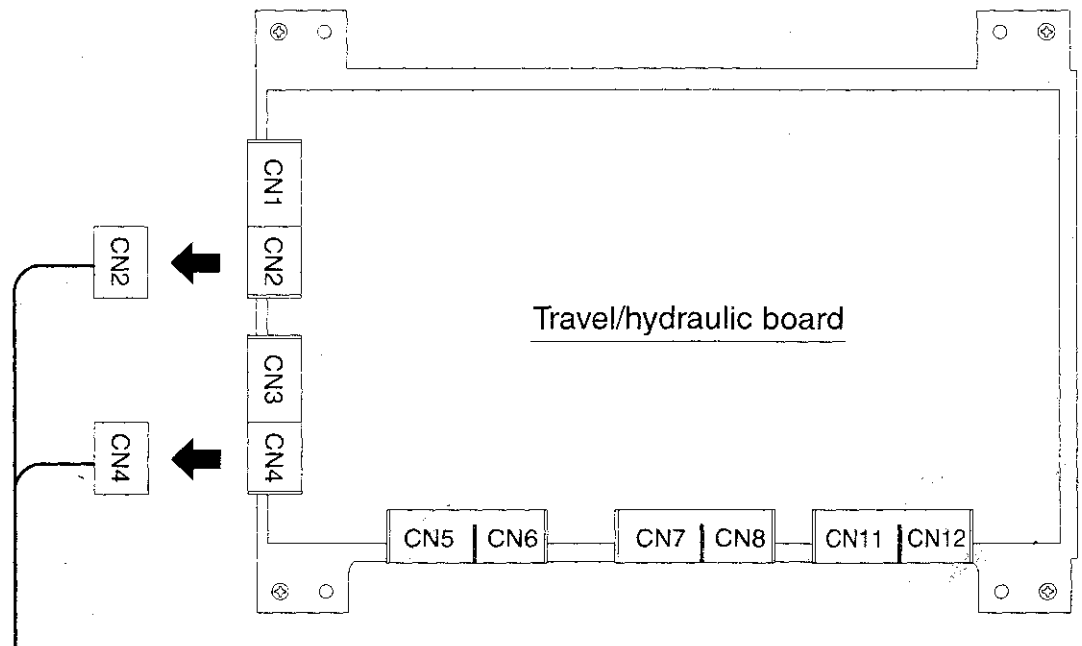

Disconnect CN2 and CN4 simultaneously.

117105



**Do not travel or manipulate the hydraulic when only one end of CN2 or CN4 is disconnected. It may damage IGBT module.**

3. Connect the battery plug and turn the key switch on.
4. Operate the accelerator, and make sure an alarm sounds, main contactor trips, and the error messages comes on as shown below.

**B11: Transistor U (travel)**  
**B12: Transistor V (travel)**  
**B13: Transistor W (travel)**

: \*Emergency stop\*  
 : \*Turn off key switch.\*

# 10-2-6. HYDRAULIC SETTING CHECK AND ADJUSTMENT

## <CHECKING PROCEDURE>

- ① Set up the rotary switch RS1 on the display board to "4".
- ② Turn the key switch ON and the following screen appears.
- ③ Make sure whether the set values for each item are set as specified specification

● DISPLAY BOARD

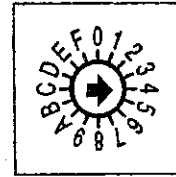

SET UP RS1 TO "4".

● Hydraulic speed set up screen

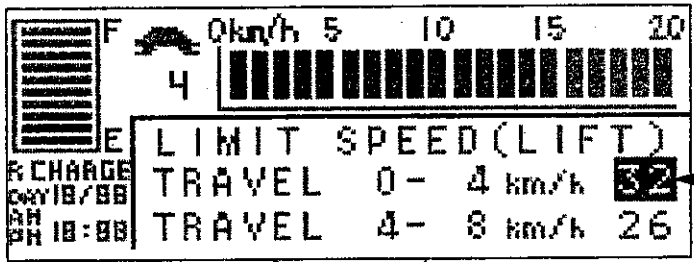

- Blinking set value
- Press the  $\triangleright$  or  $\triangleleft$ , and set the hydraulic limited speed at drive speed 0 thru 4 km/h. (0-32)

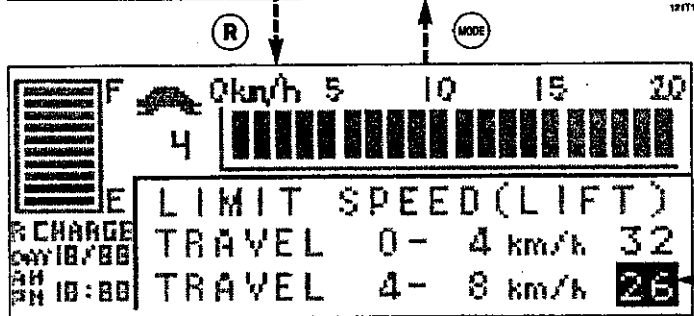

- Blinking set value
- Press the  $\triangleright$  or  $\triangleleft$ , and set the hydraulic limited speed at drive speed 4 thru 8 km/h. (0-32)

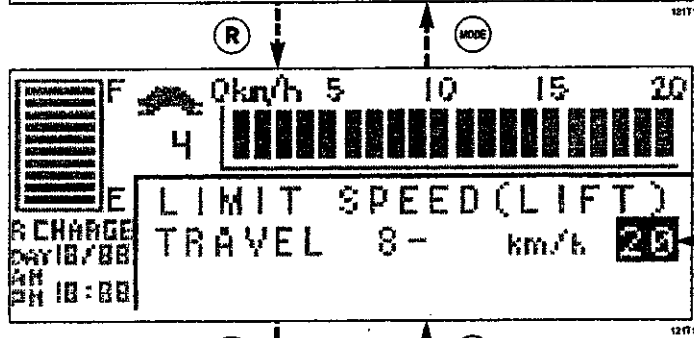

- Blinking set value
- Press the  $\triangleright$  or  $\triangleleft$ , and set the hydraulic limited speed at drive speed 8 km/h. (0-32)

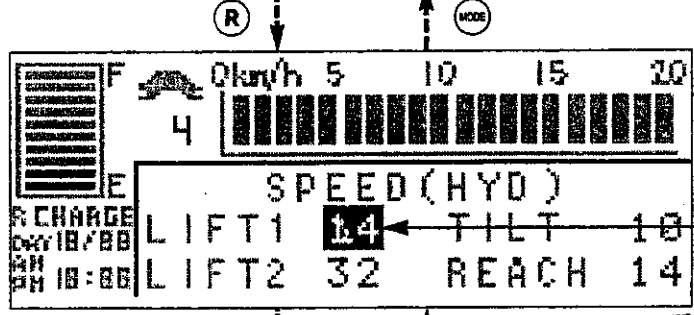

- Blinking set value
- Press the  $\triangleright$  or  $\triangleleft$ , and set the hydraulic limited speed at drive speed for LIFT1.(0-32)

(NEXT PAGE)



(FROM BEFORE PAGE)

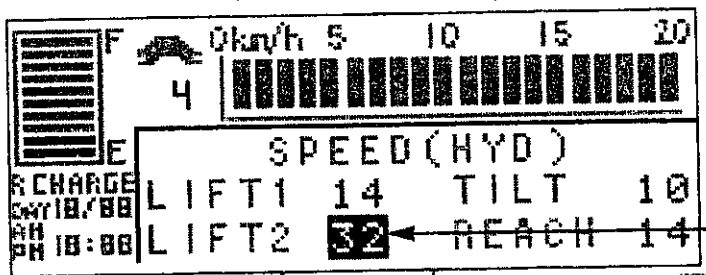

Blinking set value

- Press the  $\blacktriangleright$  or  $\blacktriangleleft$ , and set the hydraulic limited speed at drive speed for LIFT2.(0-32)

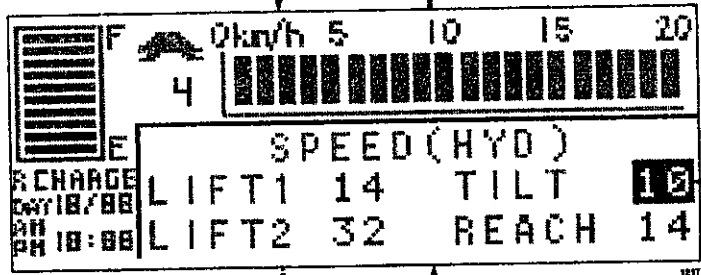

Blinking set value

- Press the  $\blacktriangleright$  or  $\blacktriangleleft$ , and set the hydraulic limited speed at drive speed for TILT.(0-32)

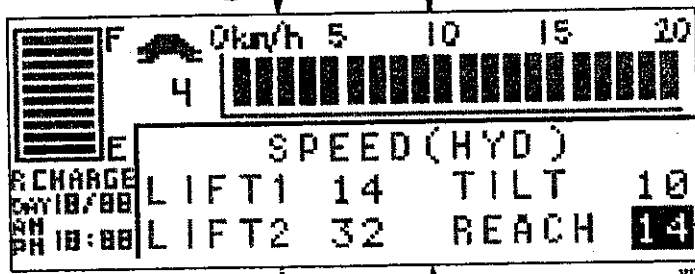

Blinking set value

- Press the  $\blacktriangleright$  or  $\blacktriangleleft$ , and set the hydraulic limited speed at drive speed for REACH.(0-32)

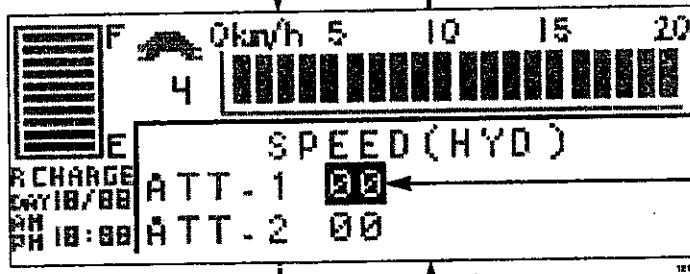

Blinking set value

- Press the  $\blacktriangleright$  or  $\blacktriangleleft$ , and set the hydraulic limited speed at drive speed for ATT1.(0-32)

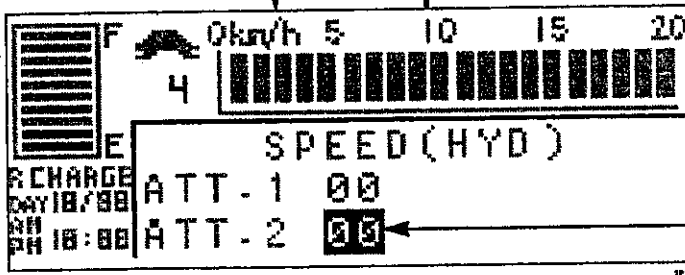

Blinking set value

- Press the  $\blacktriangleright$  or  $\blacktriangleleft$ , and set the hydraulic limited speed at drive speed for ATT2.(0-32)

<HOW TO ADJUST>

- ① Press  $\textcircled{R}$  button or the  $\textcircled{\text{MODE}}$  button, blink the set value that want to change.
- ② When pressing  $\blacktriangleright$  button, the set value is increased.
- ③ When pressing  $\blacktriangleleft$  button, the set value is decreased.

<SET VALUE OF ATTACHMENT>

A set value according to the type of the attachment is as follows.

Type of attachment	HYD ATTA set value
SF	09

**10-2-7. DESCENDING REGENERATION CHECK****<HOW TO CONFIRM>**

- ① Park the truck with the brake pedal at the suitable slope.
- ② Make sure to slow down the slope by 1km/h  $\pm$ 0.5 at free.

**10-2-8. SWITCH BACK (PLUGGING/REGENERATIVE) BRAKING FORCE ADJUSTMENT****<MEASURING CONDITIONS>**

- Flat ground, unladen, and full speed
- Specific gravity of the battery electrolyte : more than 1.25 at 20°C

**<HOW TO ADJUST>**

- ① Set up the rotary switch RS1 on the display board to "3".

▶ DISPLAY BOARD

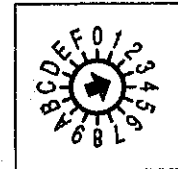

SET UP RS1 TO "3".

- ② When turning the key switch on, the following screen is displayed.

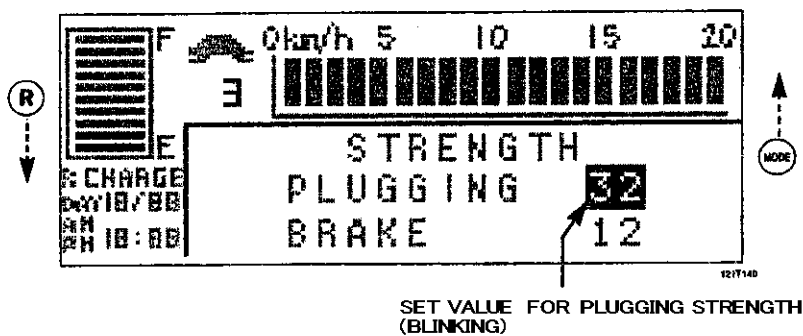

- Screen of strength level for plugging and brake



- ③ Make sure the "PLUGGING" is blinking.

**NOTE**

If "PLUGGING" is not blinked, press  button.

- ④ When pressing  button, the braking force becomes strong.
- ⑤ When pressing  button, the braking force becomes strong.

**10-2-9. REGENERATIVE BRAKING FORCE CHECK AND ADJUSTMENT**

<HOW TO CONFIRM>

- ① Cancel the neutral (released accelerator) regeneration.

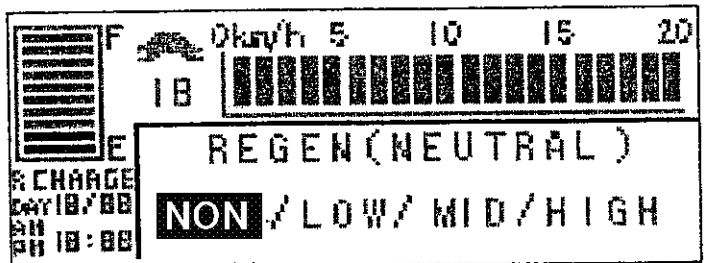

- ② Travel forward at a moderate speed and return the accelerator lever to the neutral position.
- ③ Lightly depress the brake pedal.
- ④ Check if a light braking force (regenerative braking) is applied.

<HOW TO ADJUST>

- ① Set rotary switch RS1 on the display board to "3".

● DISPLAY BOARD

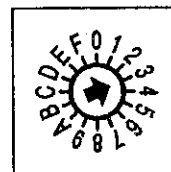

SET RS1 TO "3".

- ② Turn the key switch ON and the following screen appears.

● SCREEN FOR SET UP STRENGTH OF PLUGGING AND BRAKE

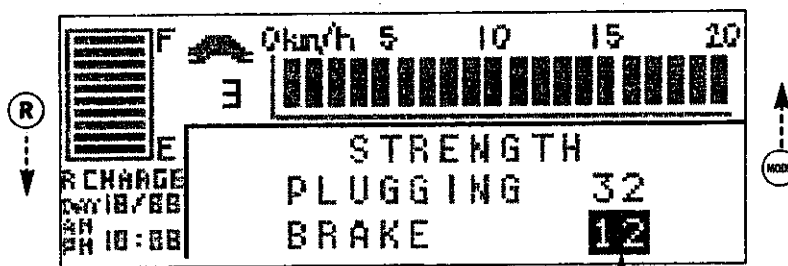

SET VALUE FOR BRAKING STRENGTH (BLINKING)

- ③ When pressing (R) button, set value for "BRAKE" is blinked.
- ④ When pressing + button, the braking becomes strong.
- ⑤ When pressing <- button, the braking becomes weak.

**10-2-10. ANTI-SLIP (FOR HIGH PERFORMANCE TRUCK)**

<MEASURING CONDITIONS>

- Only when you select the high performance mode, "ANTI SLIP" appears.

<HOW TO ADJUST>

- ① Set up the rotary wsitch RS1 on the display board to "3".

- DISPLAY BOARD

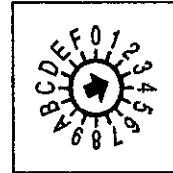

SET UP RS1 TO "3".

- ② Turn the key switch ON and the following screen appears.

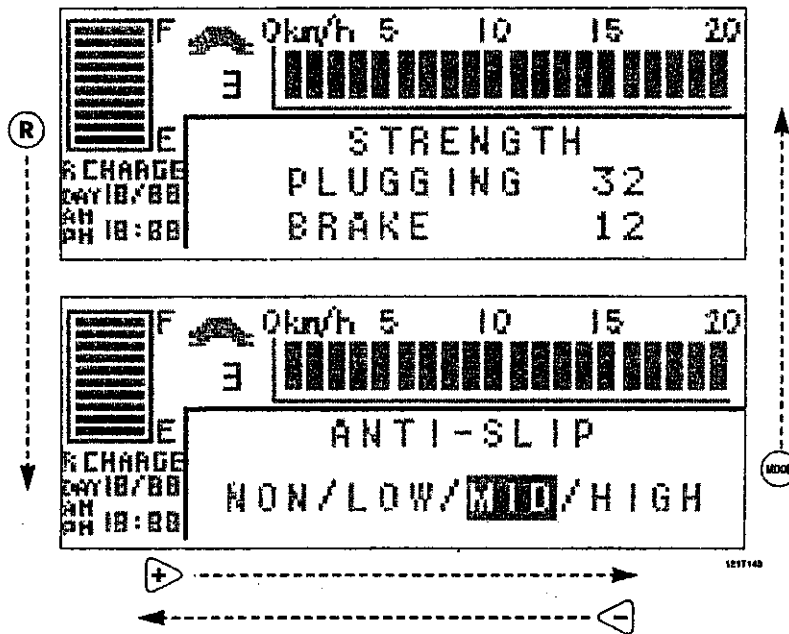

- ③ Press the (R) button to display the "ANTI SLIP" screen.
- ④ Press the (-) or (+) button to set the slippage sensitivity.

<b>10-2-11.</b>	<b>FORONT WHEEL BRAKE (FOR HIGH PERFORMANCE TRUCK)</b>
-----------------	--

**<HOW TO CONFIRM>**

- ① Turn the key switch ON.
- ② Jack up a front wheel and turn it with hand in the forward (reverse) direction.
- ③ Make sure that the brake is applied and the front wheel is locked.
- ④ Check for both front wheels.

<b>10-2-12.</b>	<b>MAKING SURE THE AUTO LOCK SUSPENTION</b>
-----------------	---

**<HOW TO CONFIRM>**

- ① Put a load on the lift with the forks extended and move up and down the lift.
  - ② Make sure that the drive wheel is locked on the truck body by the lock cylinder.
  - ③ Check that no air enters the lock cylinder.
- When the air enters, the drive is not locked completely and it feels loose.

# 10-2-13. SAFETY MONITOR SYMBOL CHECK AND ADJUSTMENT

## <HOW TO CONFIRM>

- ① Set rotary switch RS1 on the display board to "1".
- ② Turn the key switch ON and the following screen appears.
- ③ Make sure it is correctly set with the truck specification.

● DISPLAY BOARD

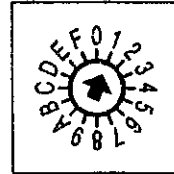

SET UP RS1 TO "1".

● SCREEN FOR MONITORING SYMBOL SET UP

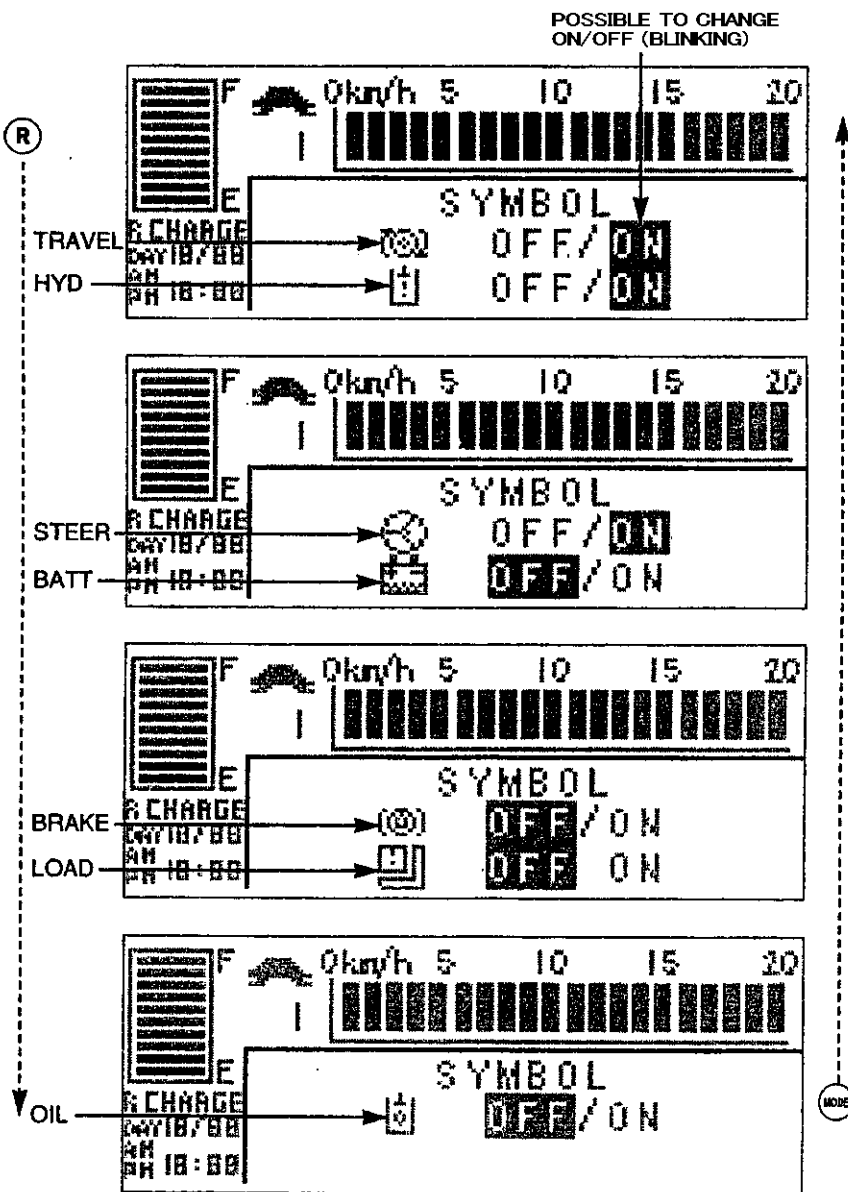

121344



<HOW TO ADJUST>

- ① Press either the **(R)** or **(MODE)** button to move the flashing icon to the item you want to change.
- ② Press the **(+)** button to turn the item ON.
- ③ Press the **(-)** button to turn the item OFF.
- ④ Turn the key switch OFF and return rotary switch RS1 to "0".
- ⑤ Turn the key on again.

The symbol indicating that the monitoring symbol setting screen is set to ON is displayed.

• DISPLAY BOARD

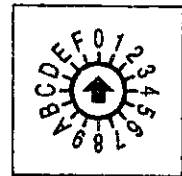

RETURN RS1 TO "0"

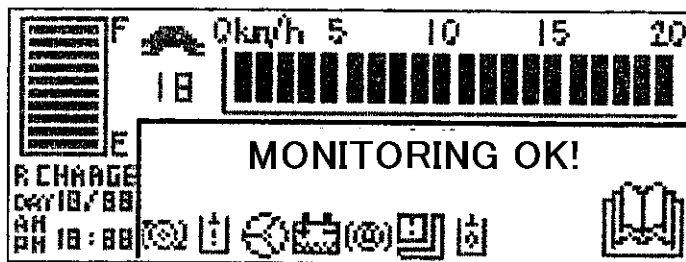

5217148

**NOTE**

When the display board is reset, TRAVEL, HYD, STEER are automatically turned ON.

**10-2-14. DISPLAY LANGUAGE CHECK AND ADJUSTMENT****<HOW TO CONFIRM>**

- ① Set rotary switch RS1 on the display board to "5".
- ② Turn the key switch ON and the following screen appears.
- ③ Check if the display language is set to your preference.

## ● DISPLAY BOARD

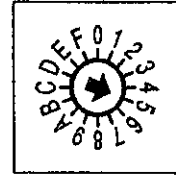

SET UP THE RS1 TO "5"

## ● LANGUAGE OF DISPLAY SETTING SCREEN

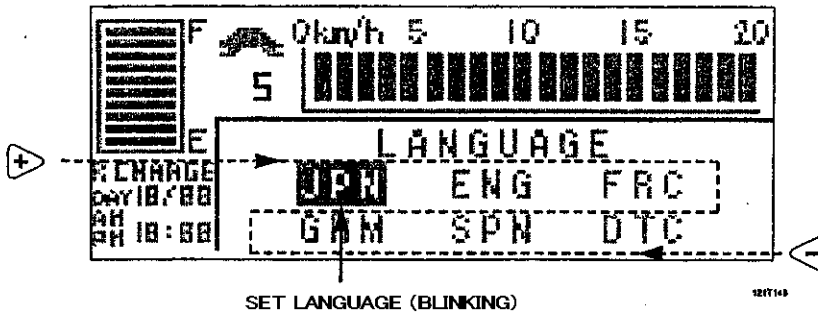
**<HOW TO ADJUST>**

- ① Press either the **+>** or **<-** button to select your preferred language.

10-2-15. OPTIONAL SETTING CHECK AND ADJUSTMENT

<HOW TO CONFIRM>

- ① Set rotary switch RS1 on the display board to "6".
- ② Turn the key switch ON and the following screen appears.
- ③ Check if the options are set to your preferences.

● DISPLAY BOARD

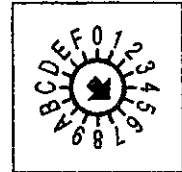

SET UP RS1 TO "6".

● OPTIONAL SETTING SCREEN

POSSIBLE TO CHANGE ON/OFF (BLINKING)

OPTIONAL SETTING SCREENS:





- Screen 1: OPTION menu with LIFT LOCK OFF/ON and SPEED LIMIT OFF ON.
- Screen 2: OPTION menu with SEAT SWITCH OFF/ON and FINGERTIP OFF ON.
- Screen 3: OPTION menu with AOS OFF/ON and POWER MODE OFF ON.
- Screen 4: OPTION menu with CHARGER OFF/ON and TILT STOP OFF ON.
- Screen 5: OPTION menu with HOUR METER 1/2 and SPEED SWITCH 2.

OPTION SET MODE		STANDARD SETTING	NOTE
LIFT LOCK	OVER DISCHARGE LIFT LOCK	OFF	The lift is locked by one "RED BAR" of the battery capacity meter.
SPEED LIMIT	HIGH LIFT HEIGHT	OFF	It's necessary to install the switch for operation separately.
SEAT SWITCH	WITH SEAT SWITCH	OFF	Fixed OFF, for FB
FINGER TIP	WITH FINGER TIP	OFF	Equiped with finger tip system hydraulic lever truck
AOS	WITH AOS	OFF	AOS function installed truck
POWER MODE	POSSIBLE TO CHANGE TRAVEL MODE	ON	Fixed on, for FB (Not set power mode)
CHARGER	POSSIBLE TO RESERVE CHARGE	ON	Not display the reservation charge setting screen
TILT STOP	TILT AUTOMATIC STOP AT HORIZONTAL	OFF	AUTO STOP FUNCTION INSTALLED TRUCK
HOUR METER 1		1	1 : TIME DURING KEY SWITCH ON 2 : TIME DURING WORKING (OPERATING HRS FOR MOTOR) SWITCHING DISPLAY (EITHER IS AVAILABLE TO COUNT WHEN NOT USED)
SPEED SWITCH 1		1	1:Use the standard turtle switch 2:Use the old turtle switch At this time, the standard turtle switch can not be used.

 NOTE

All modes on standard forklifts other than POWER MODE are set to OFF. An optional mode can only be turned ON if that option has been installed on the forklift.

## &lt;HOW TO ADJUST&gt;

- ① Press  button or  button, blink the item that want to change.
- ② When press the  button, switch to "ON" or "2".
- ③ When press the  button, switch to "OFF" or "1".

## 10-2-16. HOUR METER WORKING CHECK

<HOW TO CONFIRM>

- ① Connect the following connector

**NOTE**

**Connector terminal**

**Location** : next to the charger control device in the motor room

**Wire colors** : Blue/black and black/white

- ② Make sure that the hourglass symbol on the display flashes when the hydraulic or travel controls are operated.

**CAUTION**

After make sure, pull out the connector until delivering it.

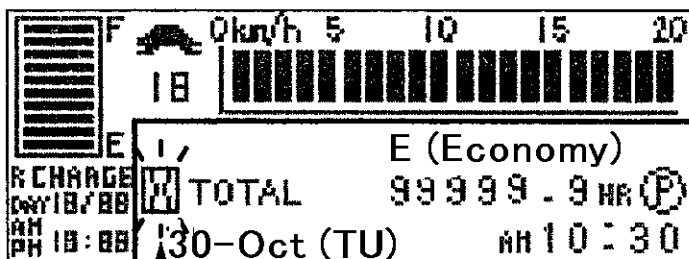
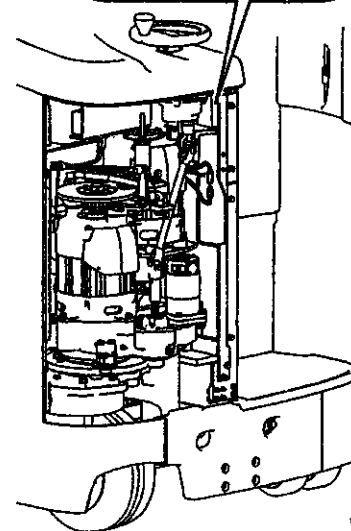
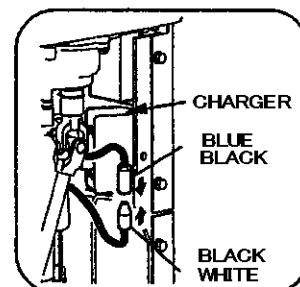

SANDGLASS (BLINKING)

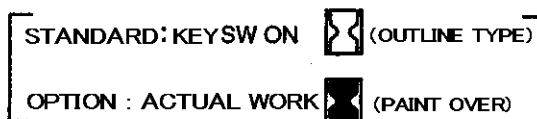

## 10-2-17. AUTO POWER OFF FUNCTION WORKING CHECK

<HOW TO CONFIRM>

- ① Turn the key switch ON.
- ② Make sure that the key turns off automatically after about 15 minutes.

## 10-2-18. BATTERY ELECTROLYTE LEVEL WORKING CHECK

### <HOW TO CONFIRM>

- ① Remove the battery electrolyte level sensor and make an electrolyte level drop status.
- ② Make sure **\*Add purified water\*** flow right-to-left on the display.

#### ● BATTERY FLUID LEVEL

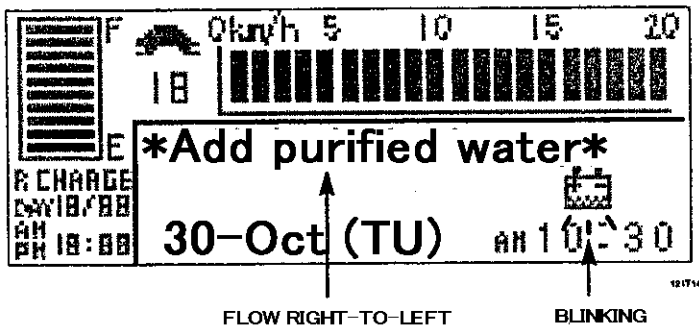

## 10-2-19. TURN SIGNAL LAMP WORKING CHECK

### <HOW TO CONFIRM>

- ① When the turn signal lever is operated, make sure that the turn signal lamp flashes and at the same time a buzzer sounds.
- ② When the turn signal lever is operated in one direction and the steering wheel is turned in the other direction within 12 seconds, make sure that the turn signal lamp goes off. However, if the steering wheel is not turned within 12 seconds, the turn signal will go off automatically.

## 1-2-20. HYDRAULIC OIL LEVEL (OPTIONAL) WORKING CHECK

### <HOW TO CONFIRM>

- ① Fully lift-up the lift and turn the key switch to ON.
- ② Make sure **\*Add lubrication oil\*** on the display.

#### ● LUBRICATION OIL (OPTION)

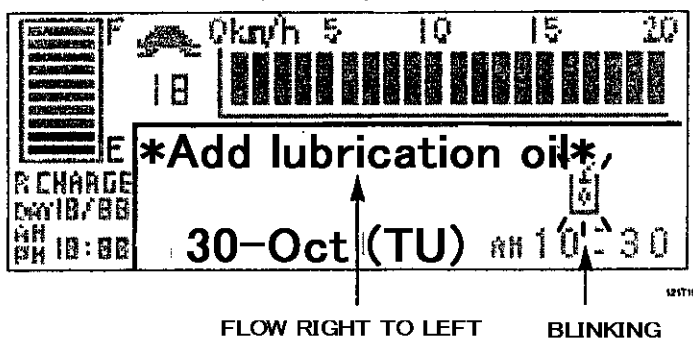



## 10-2-21. OVERLOAD (OPTIONAL) WORKING CHECK

### <HOW TO CONFIRM>

- ① Fully lift-up the fork and make a relief valve work.
- ② Make sure \*Overload.Reduce load\* flow from right to left on the display.

#### ● OVERLOAD (OPTION)

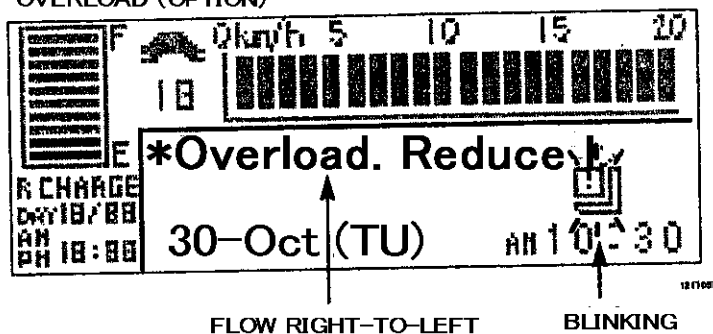

## 10-2-22. TRAVEL INHIBITOR (OPTIONAL) WORKING CHECK

### <HOW TO CONFIRM>

- ① Connect [-]wire (Black,White) with connector [CN5-2 PIN] on the travel,hydraulic board.  
(Refer to "3-1.SYSTEM WIRING")
- ② Make sure not running even if you operate the accelerator lever.

## 10-2-23. COOLING FAN WORKING CHECK

### <HOW TO CONFIRM>

- ① Make sure that the cooling fan is running at a high speed while in the traveling or hydraulic operation, or when the temperature in the control unit is 50 : or higher.
- ② While travel and hydraulic operation are stopped, make sure that the cooling fan stops when the temperature inside the control unit is 35: or less, and that it operates at low speed when the temperature inside the control unit is 40: or higher. (The cooling fan will operate at high speed when the temperature is 50: or higher.)  
(On FBR 10 series, the cooling fan will operate when key SW is turned on)

**10-2-24. LIFT LOCK AT OVER DISCHARGE (OPTION)**

<HOW TO CONFIRM>

- ① Set rotary switch RS1 on the display board to "6".
- ② Turn the key switch ON.
- ③ Set "LIFT LOCK" mode to "ON".  
Refer to "1-2-15 MAKE SURE AND ADJUST OPTION SET".

● DISPLAY BOARD

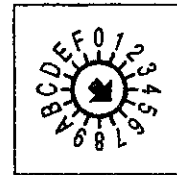

SET UP RS1 TO "6".

● OPTION SETTING SCREEN SET TO "ON" (BLINKING)

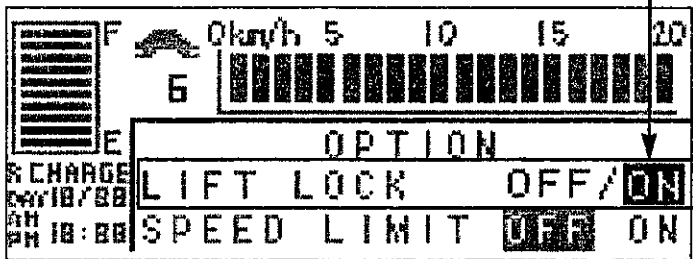

- ④ Turn the key switch OFF and return the rotary switch RS1 to "0".
- ⑤ Connect a 40 - 46V power supply to the battery plug.
- ⑥ Turn the key on again.
- ⑦ Measure the battery capacity meter light [RED], and flows \*Recharge battery\* flows right to left on the display board.

● DISPLAY BOARD

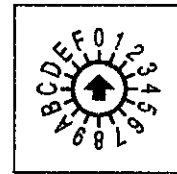

RETURN RS1 TO "0".

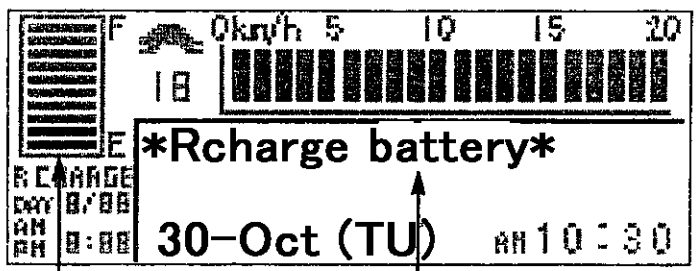

LIGHTING [E] FOLLOW RIGHT-TO-LEFT

**NOTE**

The lift speed is decelerated to 50% in the above -mentioned (two [RED]). One "RED" blinks and "Recharge battery" is displayed continuously and lift stops. (Especially, it is not necessary to confirm.)

# 1-2-25. ADJUST TURNING DECELERATION (OPTION)

## <HOW TO ADJUST>

- ① Set the rotary switch RS1 on the display board to "B".

● DISPLAY BOARD

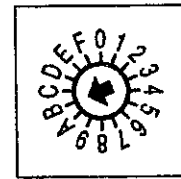

SET RS1 TO "B".

- ② When you turn on the key switch, the following screen is displayed.

● SETTING SCREEN FOR LIMITED TRAVELING SPEED

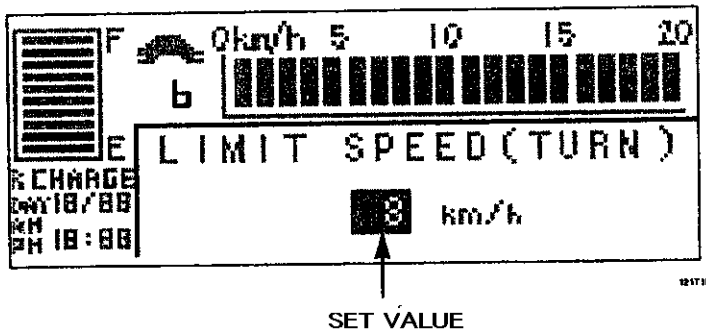

SET VALUE

- ③ Press the  $\blacktriangleright$  or  $\blacktriangleleft$ , and adjust set value (0-16km/h)
  - When you press the  $\blacktriangleright$  button, the set value increases.
  - When you press the  $\blacktriangleleft$  button, the set value decreases.

## <HOW TO CONFIRM>

- ① Put it into the state to turn steering wheel until end either right and left
- ② Operate an accelerator lever.
- ③ Make sure the speed is limited, and is not accelerated.

**CAUTION**

The installation of limit switch at turning is needed to make this option function

# 1-2-27. ACCELERATOR POTENTIOMETER ADJUSTMENT

## <HOW TO ADJUST 1>

① Set the rotary switch RS1 on the display board to "8".

• DISPLAY BOARD

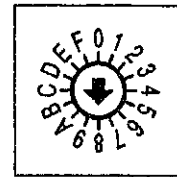

SET RS1 TO "8".

② When you turn on the key switch, the following screen is displayed.

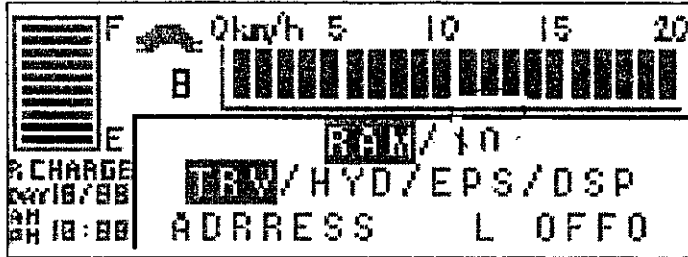

③ Press the  $\odot$ ,  $\textcircled{R}$ ,  $\blacktriangle$  or  $\blacktriangleleft$  button, set to "I/O", "TRV", "W0012".

④ Loosen and adjust the screw on the accelerator potentiometer to set "DATA" to  $200H \pm 20H$  (01E0 - 0220) with the accelerator in the neutral position.

※ The lever angle to disable the neutral switch should be within 3 - 12° for both forward and backward directions.

• I/O check mode

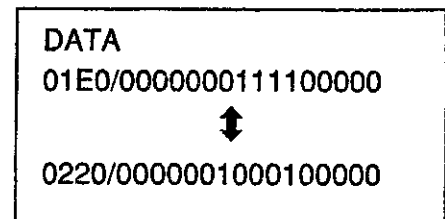
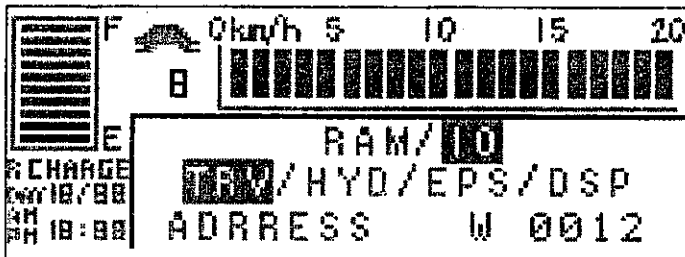

## <HOW TO ADJUST 2>

- ① Provide 5 V power supply to the accelerator potentiometer.
- ② Unplug the connector and insert the voltage measuring adaptor.
- ③ Measure the voltage of the white cord by the tester.
- ④ Loosen and adjust the screw on the accelerator potentiometer to set output voltage to  $2.5 \pm 0.15$  V with the accelerator in the neutral position.

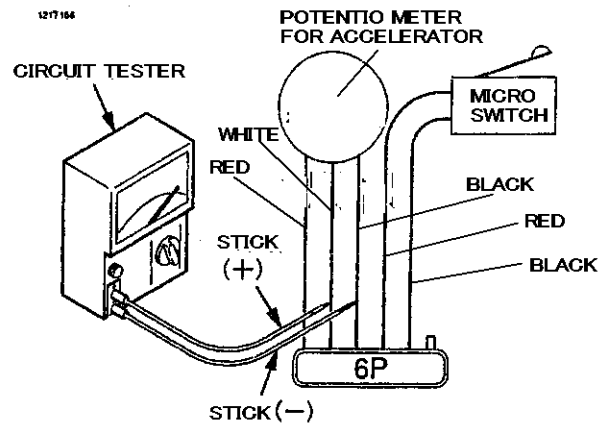

10-2-28. STEERING ANGLE POTENTIOMETER ADJUSTMENT

<HOW TO ADJUST 1>

- ① Set the rotary switch RS1 on the display board to "8".

• DISPLAY BOARD

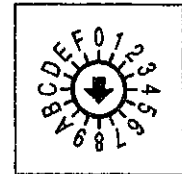

SET RS1 TO "8".

- ② When you turn on the key switch, the following screen is displayed.

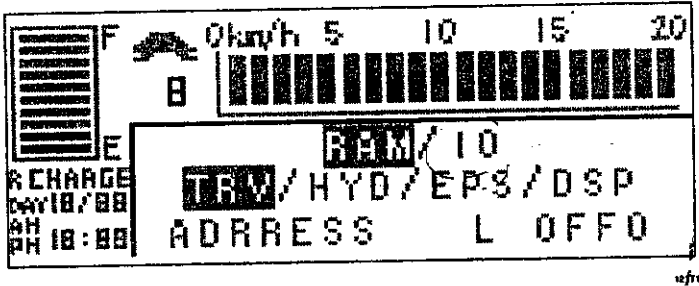

- ③ Press **MODE**, **R**, **+**, or **-** to select "I/O", "TRV", and "W0016".

- ④ Loosen and adjust the screw on the steering angle potentiometer to set "DATA" to 200H ± 10H (01F0 -0210) with the steering wheel the drive mode.

• I/O check mode

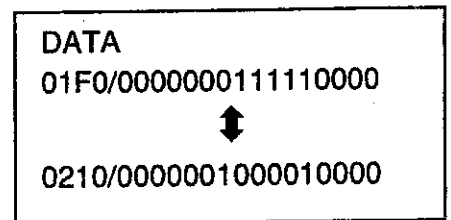
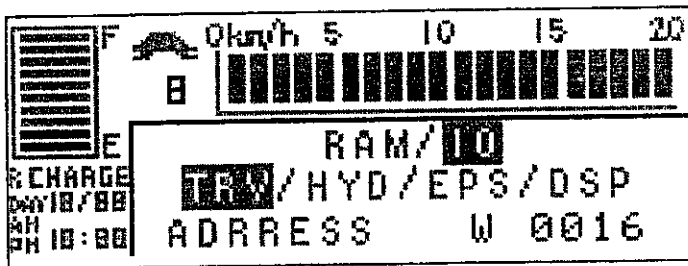

<HOW TO ADJUST 2>

- ① Provide 5 V power supply to the steering angle potentiometer.
- ② Unplug the connector and insert the voltage measuring adaptor.
- ③ Measure the voltage of the yellow/blue cord by the tester.
- ④ Loosen and adjust the screw on the lift potentiometer to set output voltage to 2.5 ± 0.15 V with the steering wheel in the drive mode.

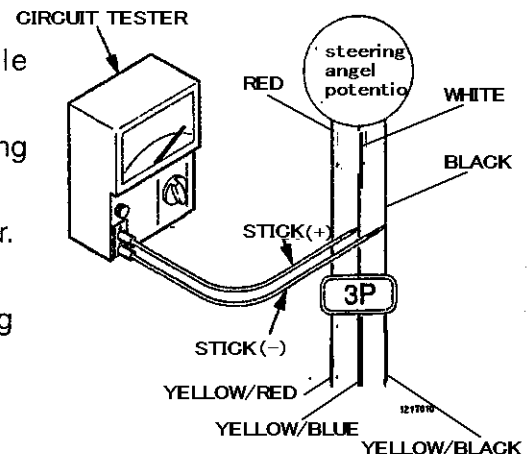

**10-2-29. TYRE DIAMETER DATA ADJUSTMENT****NOTE**

No setting is required for a new truck with standard tyres.

**<HOW TO ADJUST>**

- Follow the directions below for diameter automatic adjustment after replacing tyres.

**NOTE**

The dry, flat road surface with length of 10 m or more available is desired for diameter automatic adjustment.

- ① Turn off the key switch with the steering wheel in the drive mode.
- ② Turn on the bit 3 of the Dip switch on the travel/hydraulic board.
- ③ Turn on the key switch.
- ④ Maintain the steering wheel for the truck to stay in a straight line and travel forward and backward with the fully pressed down accelerator for more than 1 minute with no sudden acceleration or braking.
- ⑤ Turn off the key switch and the bit-3 the Dip switch on the travel/hydraulic board.

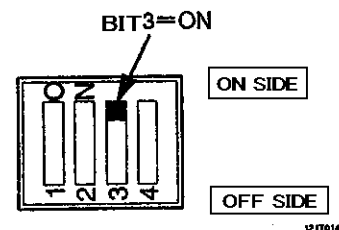
**• DIP SWITCH****10-2-30. BATTERY FRONT LOADING (TRAVEL/HYDRAULIC LOCK)**

- Battery front loading model only

**<HOW TO ADJUST>**

- ① Set the fork height and tilt to the reference position and restore the fork to the original position.
- ② Step on the battery front loading lever up to the middle of the stroke (do not push all the way).
- ③ Make sure that travel or hydraulic operations cannot be performed
- ④ Make sure the message. (\*Secure battery unit\*)

**10-2-31. NO SUSPENSION LOCK SYSTEM****<HOW TO ADJUST>**

- Turn on the bit 4 of the Dip switch on the main board.

**<HOW TO CONFIRM>**

- Check if the suspension is not locked when operating hydraulic.

10-2-32. EQUIPED CHARGER

<Total timer>

How to check		MAGNET CONTACTOR	AUTO LED	RESERVE LED	EQUAL LED	CHARGE PASSED LED	
						1~2	3~4
1	Insert the charge plug	OFF	×	×	×	×	×
2	Insert the power plug into the power supply	OFF	○	○	○	×	×
3	Press the automatic charge button more than 5 seconds	Just pressed	OFF	○	×	×	×
		After 5 seconds	ON	△	×	×	□
4	When the "AUTO LED" start blinking, you release "AUTO BUTTON".	OFF	△	×	×	□	□
5	You finish cheking after blinking "AUTO LED", it is after 1minute 36 seconds.	OFF	×	×	×	△	△

- : LIGHTING
- ×
- : CASE OF LIGHTING
- △ : BLINKING

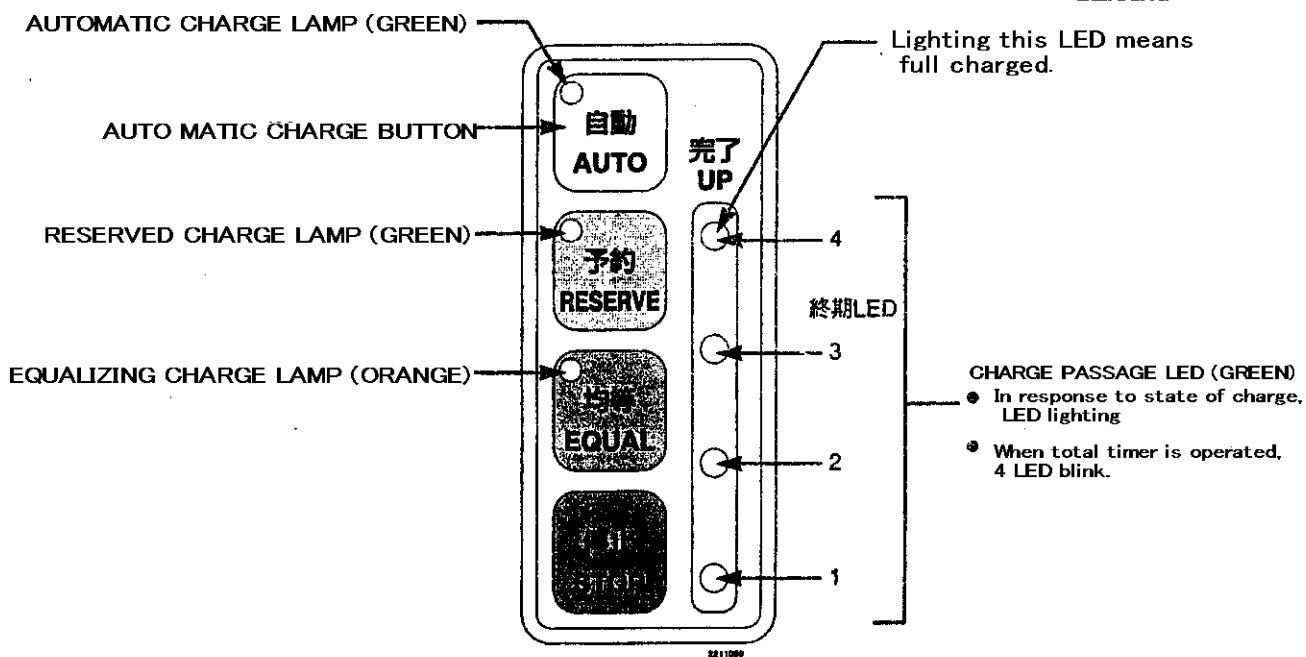

**CAUTION**

- Case of full charged battery, checking timer after hydraulic operate for rew minutes.
- When the blink the charge passage LED, don't pull out the battery plug.

Make sure the ohm between connect of charging and body.

**NOTE**

Reserved charge will be not function if "charger" of option set turn off.



# 11 TROUBLESHOOTING

## 11-1. FUNCTION OF SELF-DIAGNOSIS

### 11-1-1. DISPLAY

If abnormalities or errors are detected with the self-diagnosis function, the following symbols and error messages will be displayed on the screen.

- The applicable abnormality and/or error symbol will flash on the display.
- The applicable error message will be displayed. (If multiple abnormalities and/or errors are detected, the applicable error messages will be displayed in order.)

#### TRAVEL SYSTEM ERRORS

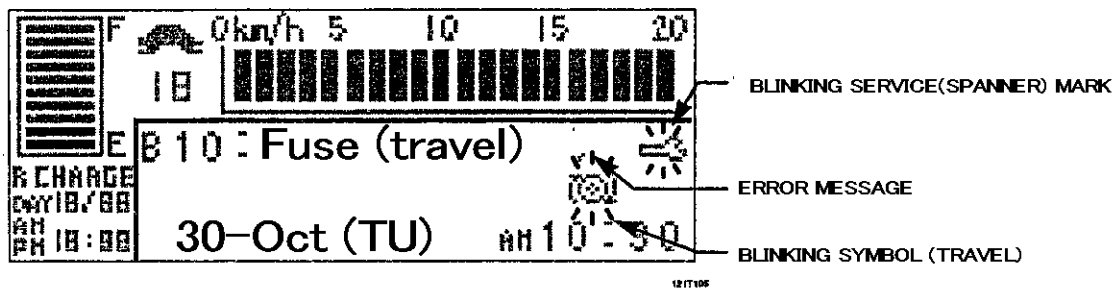

#### HYDRAULIC (INCLUDING AOS) SYSTEM ERRORS

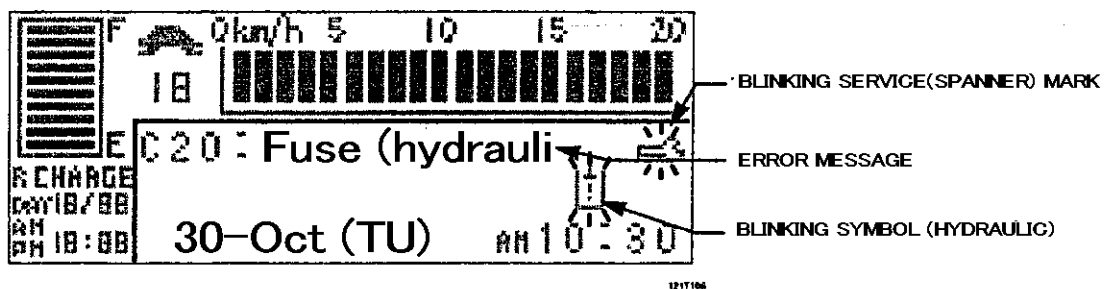

#### STEERING (EPS) SYSTEM ERRORS

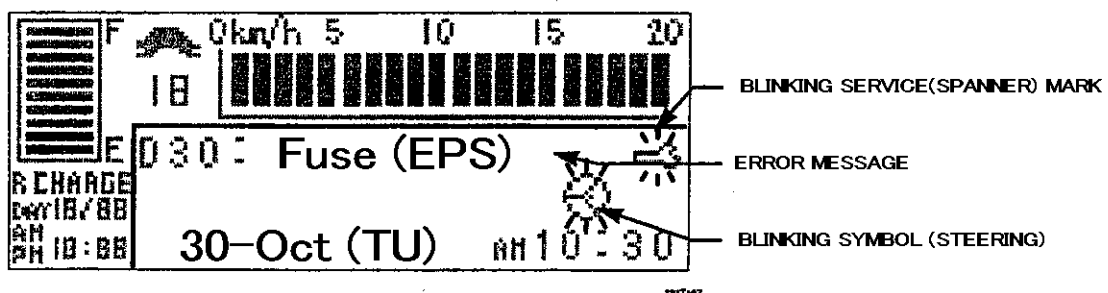

OTHER ERRORS

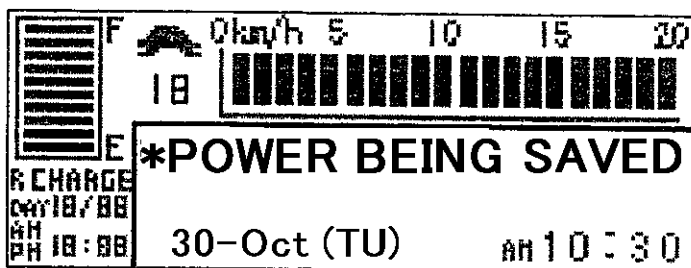

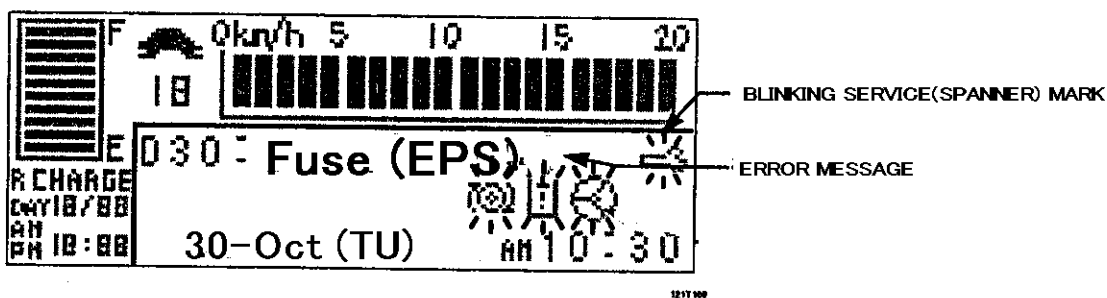

MULTIPLE ABNORMALITIES AND/OR ERRORS



NOTE

- If any of the following errors occurs, the travel, hydraulic and EPS circuits will be interlocked.
 

B11: Transistor U (travel)  
 B12: Transistor V (travel)  
 B13: Transistor W (travel)  
 C21: Transistor U (hydraulic)  
 C22: Transistor V (hydraulic)  
 C23: Transistor W (hydraulic)  
 \*Travel system electric current error\*
- Each button of , ,  is invalid while the self diagnosis. (It is not possible to shift to the charge reservation screen.)
- Don't display the self-diagnosis, while the rotary switch RS1 on the display board is set to "F". (Shift to basic screen)
- When becoming error-free, returns to the basic screen.

● DISPLAY BOARD

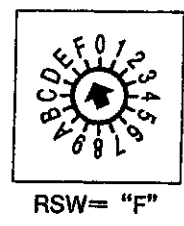

## 11-1-2. ERROR MESSAGES AND DISPLAY CONDITIONS

Error code No.	Error code	Error message	Description	Remarks
1	A1	A1: Contactor (main)	Poor contact of contactor	
2	A2	A2: Current sensor (battery)	Defective current sensor (for checking traveling and hydraulic unit current)	
10	B10	B10: Fuse (main)	Fuse is blown out	
11	B11	B11: Transistor U (travel)	Traveling motor U phase IGBT error	*Emergency stop* *Turn off key switch.*
12	B12	B12: Transistor V (travel)	Traveling motor V phase IGBT error	*Emergency stop* *Turn off key switch.*
13	B13	B13: Transistor W (travel)	Traveling motor W phase IGBT error	*Emergency stop* *Turn off key switch.*
14	B14	B14: Current sensor (travel)	Current sensor (traveling motor U and V phases) error	
15	B15	B15: Accelerator	Accelerator error	*Turn off key switch.*
20	C20			
21	C21	C21: Transistor U (hydraulic)	Hydraulic motor U phase IGBT error	*Emergency stop* *Turn off key switch.*
22	C22	C22: Transistor V (hydraulic)	Hydraulic motor V phase IGBT error	*Emergency stop* *Turn off key switch.*
23	C23	C23: Transistor W (hydraulic)	Hydraulic motor W phase IGBT error	*Emergency stop* *Turn off key switch.*
24	C24	C24: Current sensor (hydraulic)	Current sensor (hydraulic motor U and V phases) error	
25	C25	C25: Micro-switch (lift)	Lift lever micro-switch error	
25	C26	C26: Potentiometer (mast)	Tilt and lift potentiometer error	
30	D30	D30: Fuse (EPS)	EPS fuse blown out (Accelerator input reduced 1/2)	
31	D31	D31: Torque sensor (EPS)	EPS sensor error (accelerator input reduced 1/2)	*Turn off key switch.*
32	D32	D32: Transistor (EPS)	EPS's FET error (Accelerator input reduced 1/2)	*Turn off key switch.*
40	E40	E40: Transistor (AOS valve)	Valve current error	*Turn off key switch.*
41	E41	E41: Potentiometer (AOS lever)	AOS control potentiometer error	
42	E42	E42: Rotary encoder (AOS lift)	Lift height encoder error	
50	F50	F50: Fuse (front brake)	Front wheel brake power supply fuse blown out	
51	F51	F51: Potentiometer (steering angle)	Steering angle detection potentiometer error	

Error code No.	Error code	Error message	Description	Remarks
60	G60	*Current error*	Battery current error	*Emergency stop* *Turn off key switch.*
61	G61	*Traveling motor current error*	Traveling motor current error	*Turn off key switch.*
62	G62	*Hydraulic motor current error*	Hydraulic motor current error	*Turn off key switch.*
63	G63	*Traveling motor voltage error*	Traveling motor voltage error	
64	G64	*Hydraulic motor voltage error*	Hydraulic motor voltage error	
65	G65	*Power being saved:	Control board temperature error	
66	G65	*Power being saved*	Traveling motor IGBT temperature error	
67	G65	*Power being saved*	Hydraulic motor IGBT temperature error	
68	G68	*Communication error*	Display communication error	*Turn off key switch.* Communication error from display to each CPU.
69	G69	*Main board voltage error*	Voltage error of IGBT gate power supply and external 5V power supply	*Emergency stop* *Turn off key switch.*
70	G70	*Fan error*	Fan power supply voltage error	
		*Emergency stop*	Traveling or hydraulic motor relay tripped.	Displayed together with other error message.
		*Turn off key switch.*	Any critical error in traveling or hydraulic system	Displayed together with other error message.
		*Overload. Reduce load.*	Overload	When overload occurs
		*Add lubrication oil*	Lubrication oil	When lubrication oil sensor actuates
		*Add brake oil*	Brake oil	When brake oil sensor actuates
		*Add purified water*	Addition of purified water to battery	When battery electrolyte level sensor actuates
		*Recharge battery*	Battery's state of charge is low	When battery's state of charge is low.
		*Parking brake is applied*	Starting of truck is tried with parking brake applied.	When starting of truck is tried with parking brake applied.
		*Turn off accelerator*	Traveling with key switch ON.	When traveling CPU is in neutral safety state.
		*Turn off hydraulic lever*	Hydraulic lever is in ON with key switch turned ON.	When hydraulic CPU is in neutral safety state.
		*AOS emergency stop*	AOS emergency stop switch has been pressed.	AOS emergency stop switch pressed
		*Lift height setting error*	Lifting height setting is wrong.	Lifting height setting is wrong.
		*Apply parking brake*	Application of parking brake is forgotten	Parking brake&seat switch is off.
		*Secure battery unit*	Traveling or hydraulic operation is performed with battery interlock switch ON.	

# 11-2. ERROR HISTORY MEMORY

## 11-2-1. ERROR HISTORY MEMORY 1

<THE 10 MOST RECENTLY DETECTED ERRORS/ ABNORMALITIES>

- ① Set the rotary switch RS1 on the display board to "9".
- ② When turning the key switch on, the following screen is displayed.

• DISPLAY BOARD

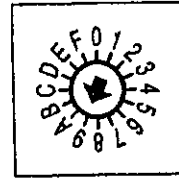

SET UP RS1 TO "9"

**NOTE**

- To view less than the ten most recent errors/ abnormalities, place the flashing cursor on the last error/abnormality and press the (R) button to go to "Previously detected errors/abnormalities".
- If there are no errors/abnormalities, press the (R) button to go to "Previously detected errors/ abnormalities".

• The 10 most recently detected errors/ abnormalities

The most recent error/abnormality flashes as "A01".

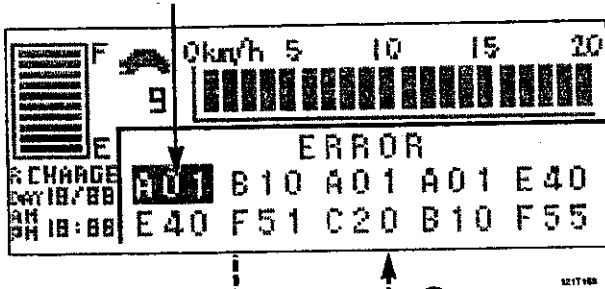

The second error/abnormality flashes as "B10".

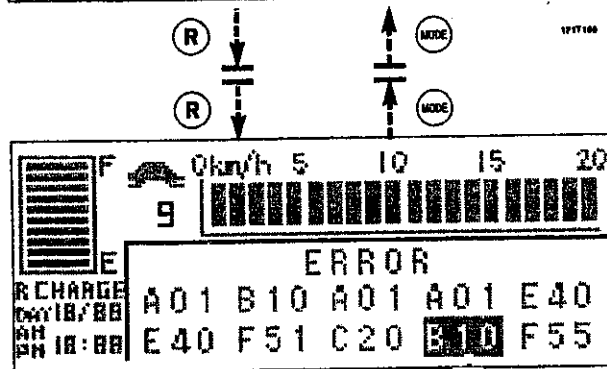
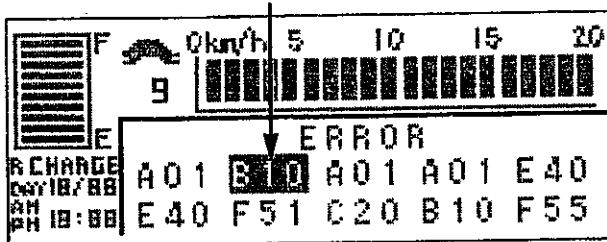

The ninth error/abnormality flashes as "B10".



• Error/abnormality details

Number of times the error/abnormality occurred when it was detected

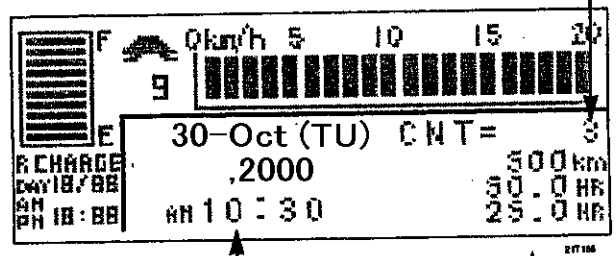

Year, month, day, and the time of the error occurrence

Error/abnormality detection date, time, travel distance, and travel and hydraulic hour mete

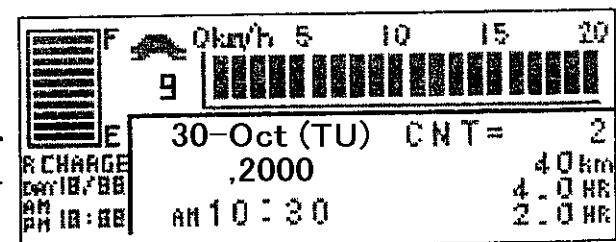
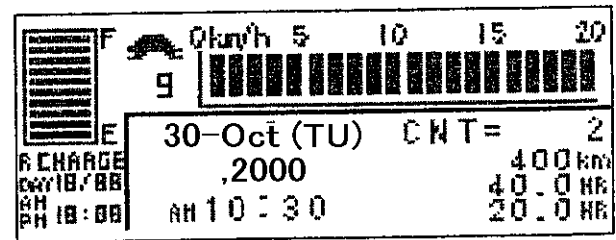

(From the previous page)

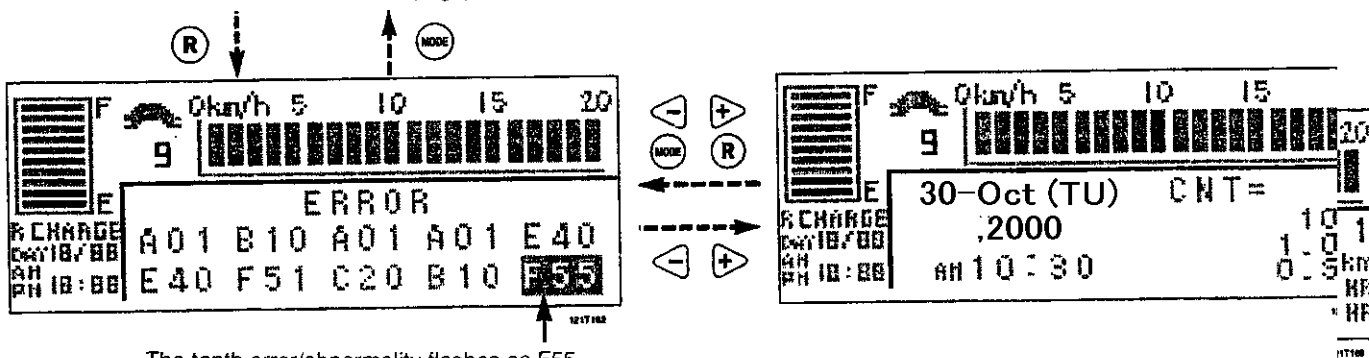

The tenth error/abnormality flashes as F55.

The next page is "Previously detected errors/abnormalities (1)".

## 11-2-2. ERROR HISTORY MEMORY 2

### <PREVIOUSLY DETECTED ERRORS/ABNORMALITIES (1)>

### • DISPLAY BOARD

• Rotary switch RS1 on display board : 9



- If there are no previous errors/abnormalities displayed in the list, press the (R) button to go to "Previously detected errors/abnormalities (2)".
- If the same error/abnormality was detected multiple times previously, the data of the most recent detection will be displayed under "Error/abnormality details".
- Flashing : Indicates the position of cursor.
- Highlighted : Only highlighted numbers are memorized as error items.



RS1=9

### • PREVIOUSLY DETECTED ERRORS/ABNORMALITIES (1)

### • ERROR/ABNORMALITY DETAILS

The previous page is "The 10 most recently detected errors/abnormalities".

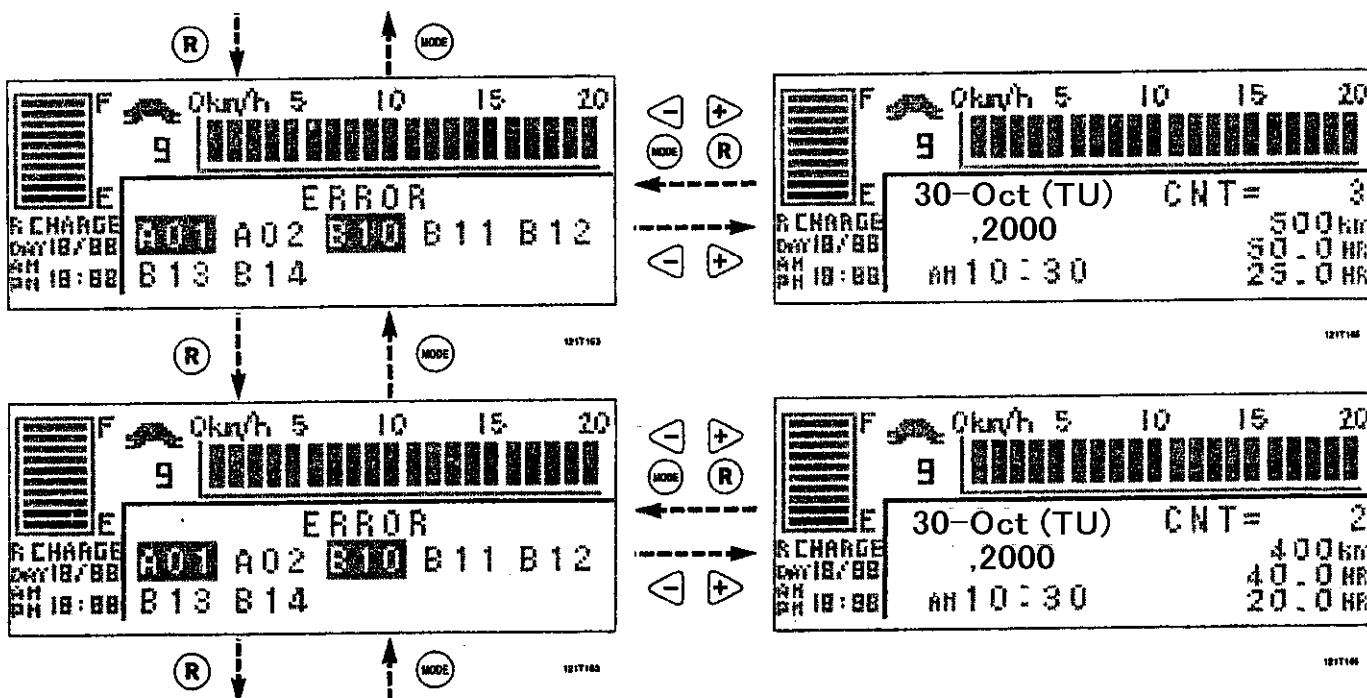

The next page is "Previously detected errors/abnormalities (4)".

<PREVIOUSLY DETECTED ERRORS/ABNORMALITIES (2)>

● DISPLAY BOARD

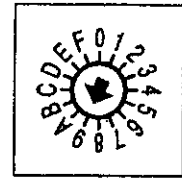

RS1=9



● In case of detected multiple same errors in the past, the last detected data is displayed on detail of the error.

● PREVIOUSLY DETECTED ERRORS/ABNORMALITIES (2) ● ERROR/ABNORMALITY DETAILS

The previous page is "Previously detected errors/abnormalities (1)".

Number of times the error/abnormality occurred when it was detected

Error/abnormality message display

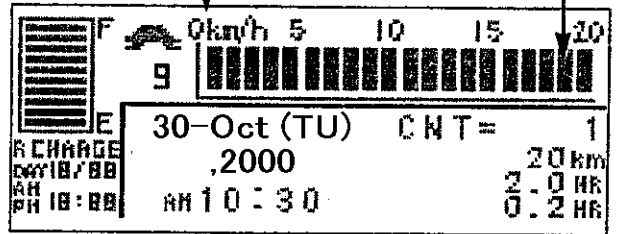
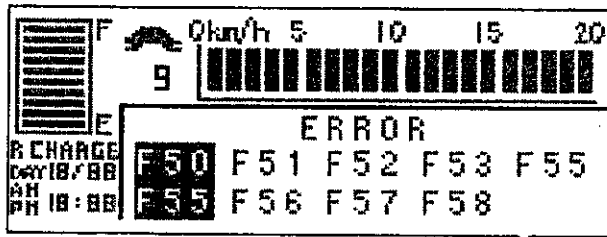

Error/abnormality detection date, time, travel distance, and travel and hydraulic hour meter

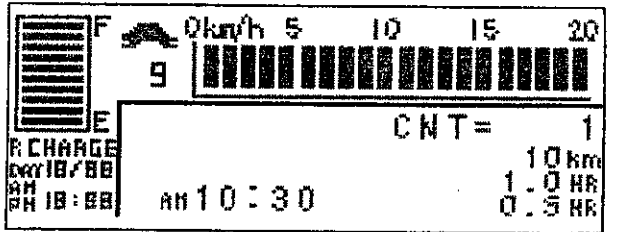
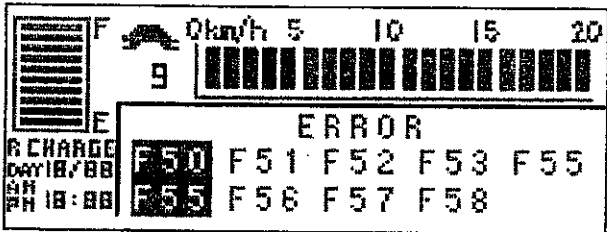



**11-2-3. MEMORY INITIALIZATION**

- ① Set rotary switch RS1 on the display board to "E".
- ② Turn the key switch ON.
- ③ When the screen shown below is displayed, memory initialization is complete.
- ④ Return rotary switch RS1 on the display board to "0".

## ● DISPLAY BOARD

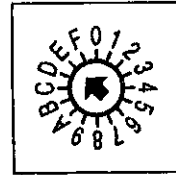

SET UP RA1 TO "E"

## ● MEMORY INITIALIZATION COMPLETION SCREEN

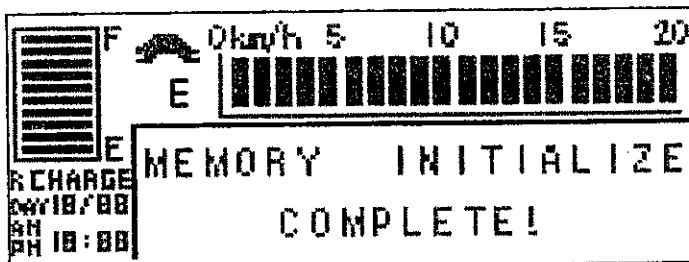

12/11/06

**NOTE**

The following items are returned to their initial values:

- Slow speed (turtle) : 5km/h
- Travel mode : N (NORMAL)
- Meter mode : HR (hour meter)
- Accelerator released (neutral) regenerative force: MID
- Error history : All clear
- BRIGHTNESS (back light brightness): 5

# 13 BATTERY AND CHARGER

## ■ CHARGING THE BATTERY (TRUCK-MOUNTED CHARGER)

### ▶ TRUCK -MOUNTED CHARGER

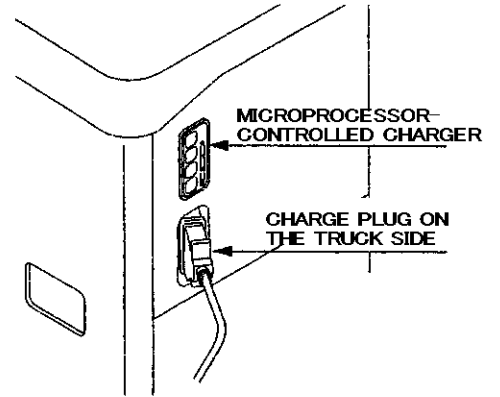

### ▶ MICROPROCESSOR-CONTROLLED CHARGER

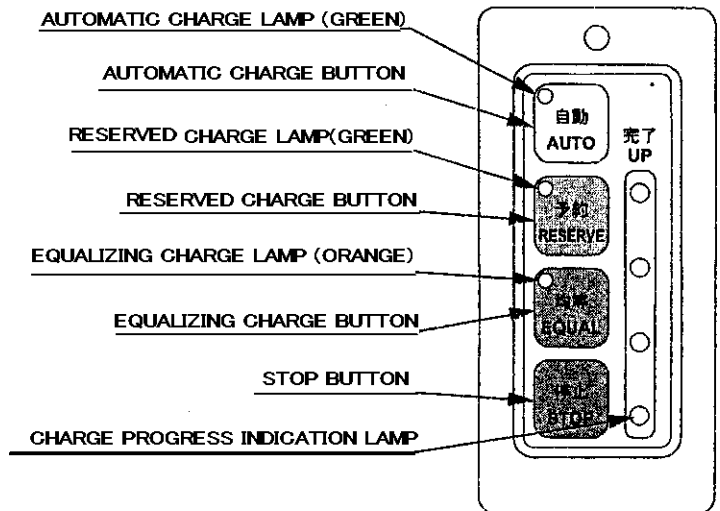

▶ **AUTOMATIC CHARGE (DAILY CHARGE)**

Automatic charge is used for recovering the battery after the day's work or your shift.

- ① Move the truck to the specified charging place where the power supply equipment for the charger is installed.
- ② Turn the key switch to OFF.
- ③ Open the battery cover.

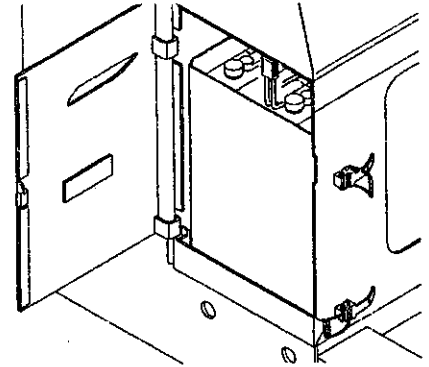
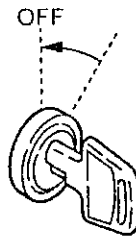

- ④ Insert the charge plug into the mating receptacle on the truck side.

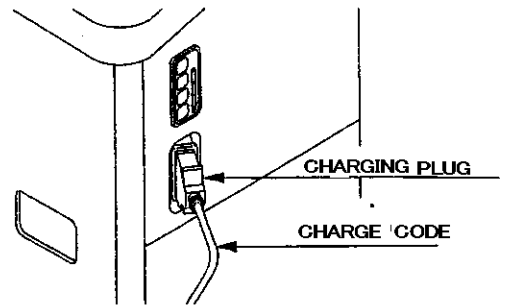

- ⑤ Insert the power plug into the power supply.

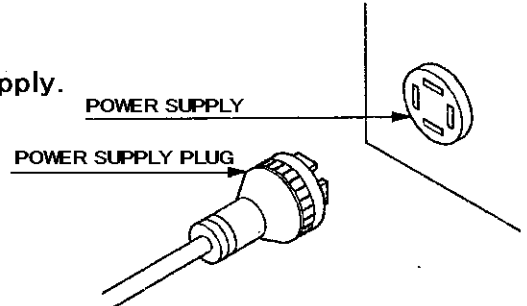

The automatic charge lamp (green), the reserved charge lamp (green) and the equalizing charge lamp (orange) come on.

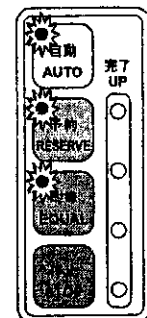

## 13 BATTERY AND CHARGER

⑥ Press the automatic charge button.

The automatic charge lamp (green) stays on while the reserved charge lamp (green) and equalizing charge lamp (orange) to go out.

AUTOMATIC CHARGE START

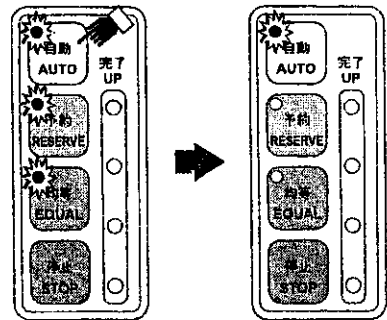

⑦ The charge progress indication lamps come on one by one as charge progresses, starting from the one at the bottom. When the lamp (green) at the top comes on, charging is completed.

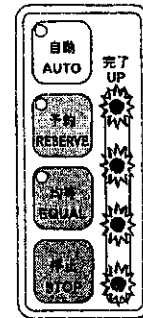

The charge stops automatically

⑧ Disconnect the charge plug and the power supply plug and store the charge cable.

⑨ Close the battery cover, and lock to the battery clamp.



Never disconnect the charge plug, the power supply plug or the battery plug while charging.

When you want to stop charging halfway, press the stop button



Make sure your hand is not wet when connecting or disconnecting charge plugs. Dry your hand or put on a glove, if it is wet.

- The charger is a high-voltage device. Never put your hand inside the equipment. Otherwise, you might get injured.

► **RESERVED CHARGE**

You can give a reserved charge using the procedure given on pages that follow.

Reserved charges are usually used to charge the battery using cheap electricity during the night or when you want to have the battery fully charged before starting work after the truck has been out of service for a long period of time.

● **SETTING CHARGE START TIME**



- If you run the truck or operate the hydraulic controls with the Reserved charge screen shown, the display will return to the basic screen.
- The Reserved charge setup mode is disabled while the truck is traveling or the brake pedal is being pressed.

- ① Move the truck to the specified charging place where the power supply equipment for the charger is installed.
- ② With the basic screen shown on the display, press the **Ⓜ** button of the screen selection buttons to display the Reserved charge set up screen.  
(The Reserved charge screen sldo appears when the charge plug is connected.)  
You can return to the basic by pressing the **Ⓜ** button.
- ③ "Set date" blinks on the screen.  
Press either the **◀** button or the **▶** button to select "Set date" or "Everyday".



When you select "Set date":  
The reserved charge time once specified on the screen will automatically be renewed every week (once every seven days) after the set dcate has passed. This function comes in handy when you want to charge the battery.

When you select "Everyday":  
The reserved charge time once specified on the screen will automatically be renewed everyday after the set time of day has passed. This function comes in handy for daily charge.



Remember that the time that can be specified on the screen is the reserved charge "start" time, not the "end" time.

**BASIC SCREEN**

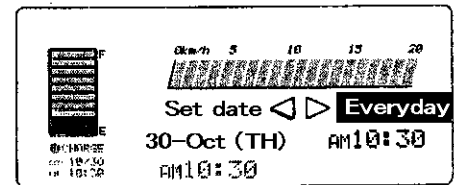
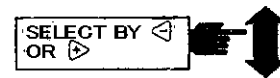
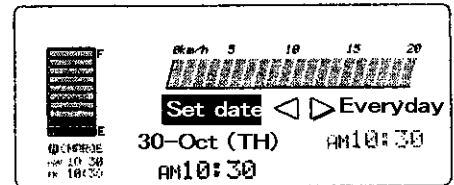
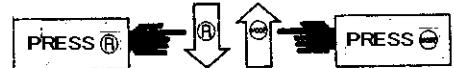
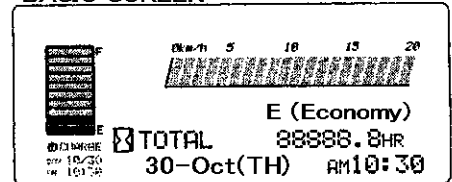

※ SELECTING "DATE"

Press ◀ or ▶ to display the "Set date" screen. "Set date" blinking on screen. The current settings are displayed. ( No settings are displayed if any reserved charge is not set.)

Press the Ⓡ button to highlight the "Month".

You can return to the basic screen by pressing the Ⓜ button.



When you set next ①-③ mode,

press the Ⓡ, Ⓜ, ◀, ▶ button of mode select.

- ◀, ▶ button → Set selected item (blinking)
- Ⓡ button → Shift to next item (blinking)
- Ⓜ button → Return to before item (blinking)

① Setting "Month"

After making sure that "Month" is selected (blinking), use ◀ and ▶ to set the month within the range from 1 to 12.

After setting the month, press the Ⓡ button to select "Date any day of the week"

You can return to the "Set date/Everyday" screen by pressing Ⓜ button.

② Setting "Date and day of the week"

After making sure that "Date and day of the week" is selected (blinking), use ◀ and ▶ to set the month within the range from 1 to 31.

The day of the week changes as the date changes.

After setting the date and day of the week, press the Ⓡ button to select "Date any day of the week"

You can return to the "Set date/Everyday" screen by pressing Ⓜ button.

③ Setting "AM/PM"

After making sure "AM/PM" is selected (blinking), use ◀ and ▶ to set AM/PM.

After selecting AM/PM, press the Ⓡ button to select "Time of day" section.

You can return to the "Date and day of the week" section by pressing Ⓜ button.

SCREEN OF "Set date"

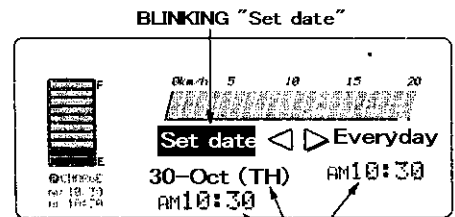

RESERVED CONTENTS

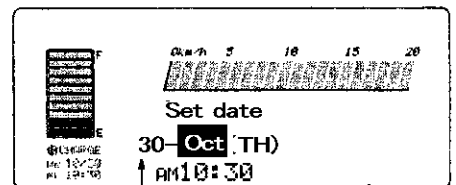
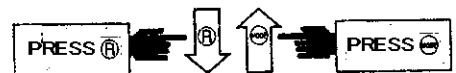

SET "MONTH" WITH ◀▶

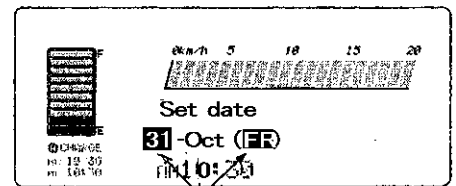
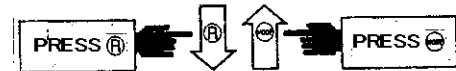

SET "Date" WITH ◀▶

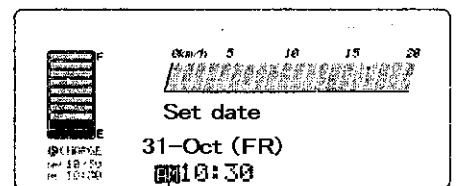

SET "AM/PM" WITH ◀▶



④ Setting "Time of day"

After making sure that "Time of day" is selected (blinking), use and to set the time of day within the range from 1 to 12.

After setting the time of day, press the button to select "Minute"

You can return to the "AM/PM" section by pressing the button.

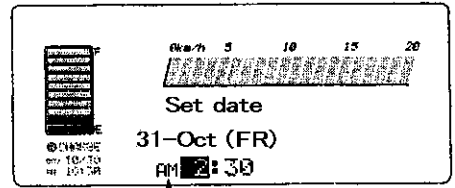

SET "Time" WITH



⑤ Setting "Minute"

After making sure that "Minute" is selected (blinking), use and to set the minute in four stages (00/15/30/45).

You can return to the "Time of day" section by pressing the button.

After all the data have been correctly entered, press button. "COMPLETE" blinks three times on screen before the display returns to the basic screen.

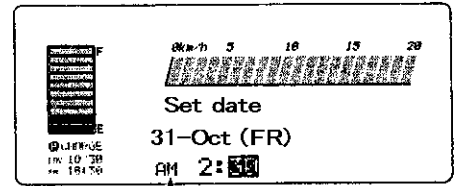

SET "Minute" WITH

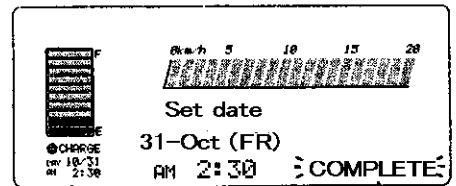

BKLINKING "COMPLETE" 3 TIMES

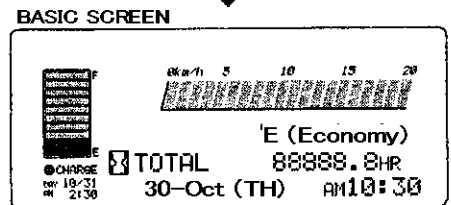

Make sure that the reserved charge starting date and time have been correctly entered, by looking at the date and time of day displayed at the left lower area of the screen.



- You cannot set any time of day in the past as the reserved charge start time.

Example) Present time of day	Oct 30, 2003	PM 10:30
	↓	
If you enter:	Oct 30	PM 10:30
	↓	
The final setting:	Oct 30, 2004	PM 10:30

If you enter a time of day of the past, the same time of day of the following year will be set

\*The same holds true if the present reserved charge time setting becomes the "past" as a result that the date and time of day settings of the display are corrected for any reason.

- The whole reserved charge setting will become void if you fail to enter any of the month, day and time of day.

Example : If you do not enter data about the day, such as "(blank) October, PM 10:00," the whole setting will be void.

If you move to the next screen, leaving any item blank, the whole setting on the same screen will become void



# 13 BATTERY AND CHARGER

## ※ SELECTING EVERY DAY

Press the ◀ button or the ▶ button to display the "Everyday" screen. "Everyday" blinks.

The current settings are displayed. (No settings are displayed if any reserved charge is not set.)

Press the Ⓡ button to select "AM/PM". You can return to the basic screen by pressing the Ⓜ button.



When you set next ①-⑥ mode,

press the Ⓡ, Ⓜ, ◀, ▶ button of mode select.

- ◀, ▶ button → Set selected item (blinking)
- Ⓡ button → Shift to next item (blinking)
- Ⓜ button → Return to before item (blinking)

### ① Setting "AM/PM"

After making sure that "AM/PM" is selected (blinking), use ◀ and ▶ to set the AM or PM.

After selecting AM or PM, press the Ⓡ button to select "Time of day".

You can return to the basic screen by pressing the Ⓜ button.

"Everyday" SCREEN

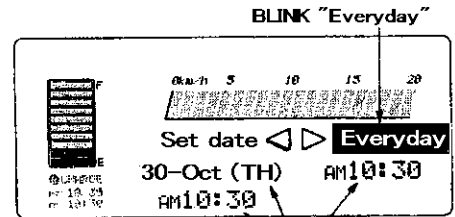

PRESENT, RESERVED CONTENTS

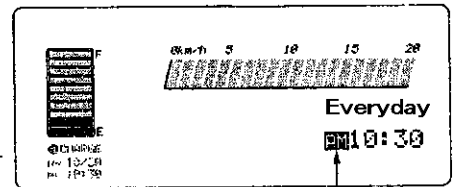

SET "AM/PM" WITH ◀▶

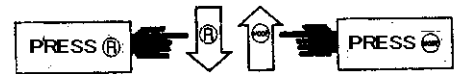

### ② Setting "Time of day"

After making sure that "Time of day" is selected (blinking), use ◀ and ▶ to set the time of day within the range of 1 to 12.

After selecting the time of day, press the Ⓡ button to select the "Minute" section.

You can return to the "AM/PM" section by pressing the Ⓜ button.

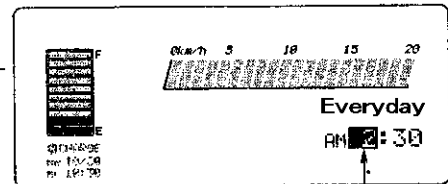

SET "Time" WITH ◀▶



### ③ Setting "Minutes"

After making sure that "Minute" is selected (blinking), use ◀ and ▶ to set the minute in four stages (00/15/30/45).

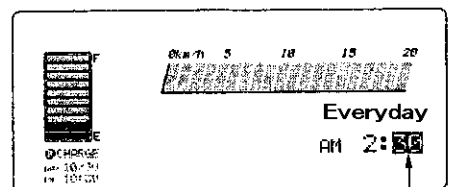

SET "Minute" WITH ◀▶



After all data have been correctly entered, press **Ⓜ** button. "COMPLETE" blinks three times on screen before the display returns to the basic screen. You can return to the "Time of day" section by pressing the **Ⓜ** button.



Make sure that the reserved charge starting date and time have been correctly entered, by looking at the date and time of day displayed at the left lower area of the screen.



- You cannot set any time of day in the past as the reserved charge start time.

Example) Present time Oct 30, 2003 PM 10:30  
 ↓  
 If you enter : PM 10:30  
 ↓  
 The final setting : Oct 31, 2003 PM 10:30

If you enter a time of day of the past, the same time of day of the following year will be set.

\* The same holds true if the present reserved charge time setting becomes the "past" as a result that the date and time of day settings of the display are corrected for any reason.

- The whole reserved charge setting will become void if you fail to enter any of the month, day and time of day.

Example : If you do not enter data about the day, such as "PM (blink)", the whole setting will be void.

If you move to the next screen, leaving any item blink, the whole setting on the same screen will become void.

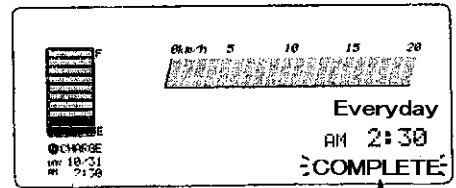

BKLINKING "COMPLETE" 3 TIMES

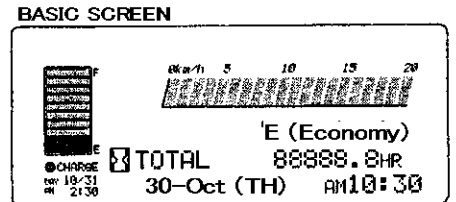

# 12 CHARGER

## 12-1. RESOLUTION AND ASSEMBLE

### 12-1-1. RESOLUTION AND ASSEMBLE CHARGER ASS'Y

**CAUTION**

- When you assemble, take care that you don't mistake to connect ground wire.
- Make sure that you don't mistake connecting lead wire to each parts.
- Tighten firmly so that the lead wire should not loosen.
- The naked part such as the transformer terminals must not contact with other parts. Cover with the insulation tube, and separate with metallic part.

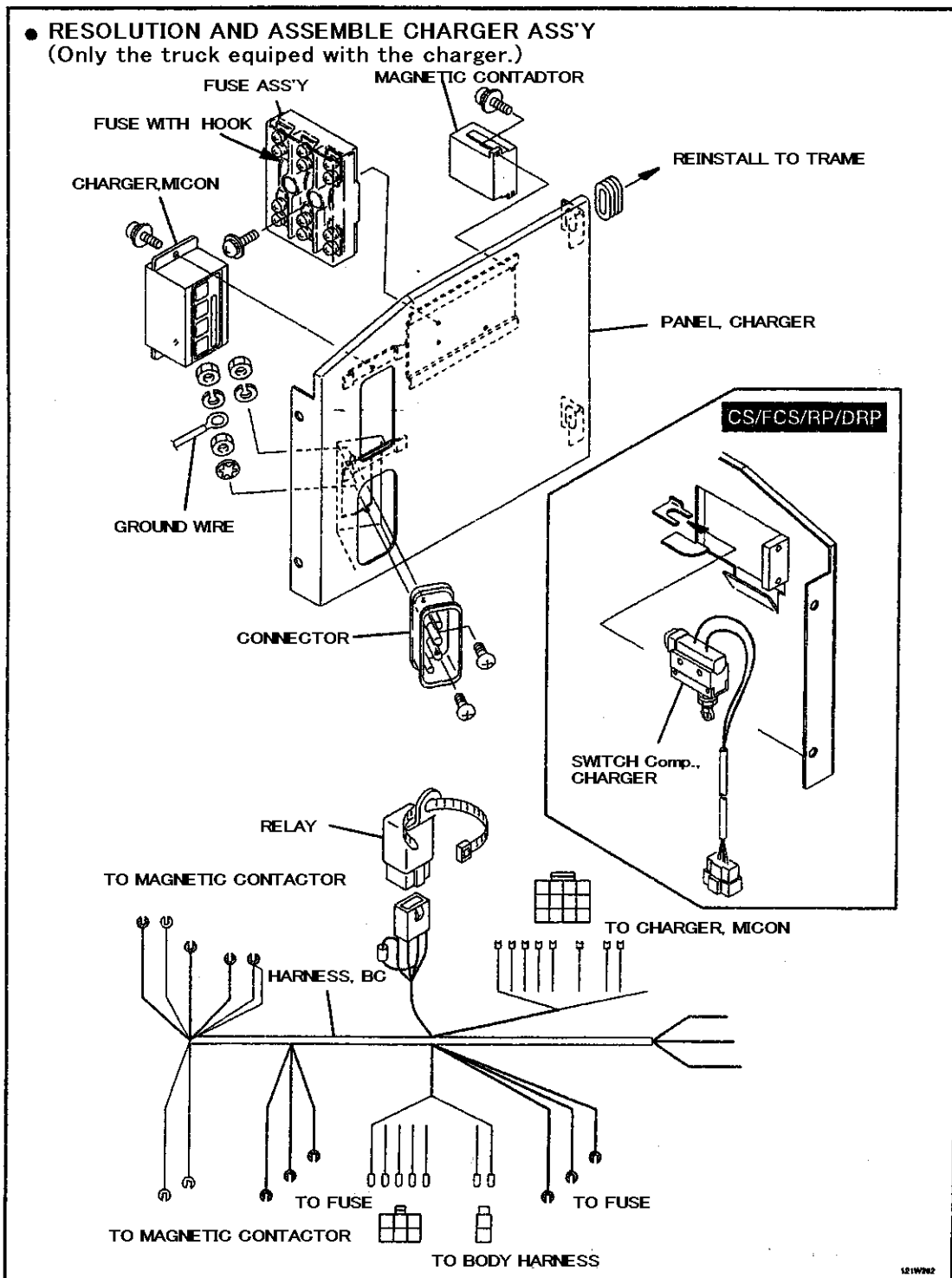

12-1-2. DISMANTLING AND ASSEMBLING TRANSFORMER

- DISMANTLING AND ASSEMBLING TRANSFORMER  
(Only the truck equipped with the charger)

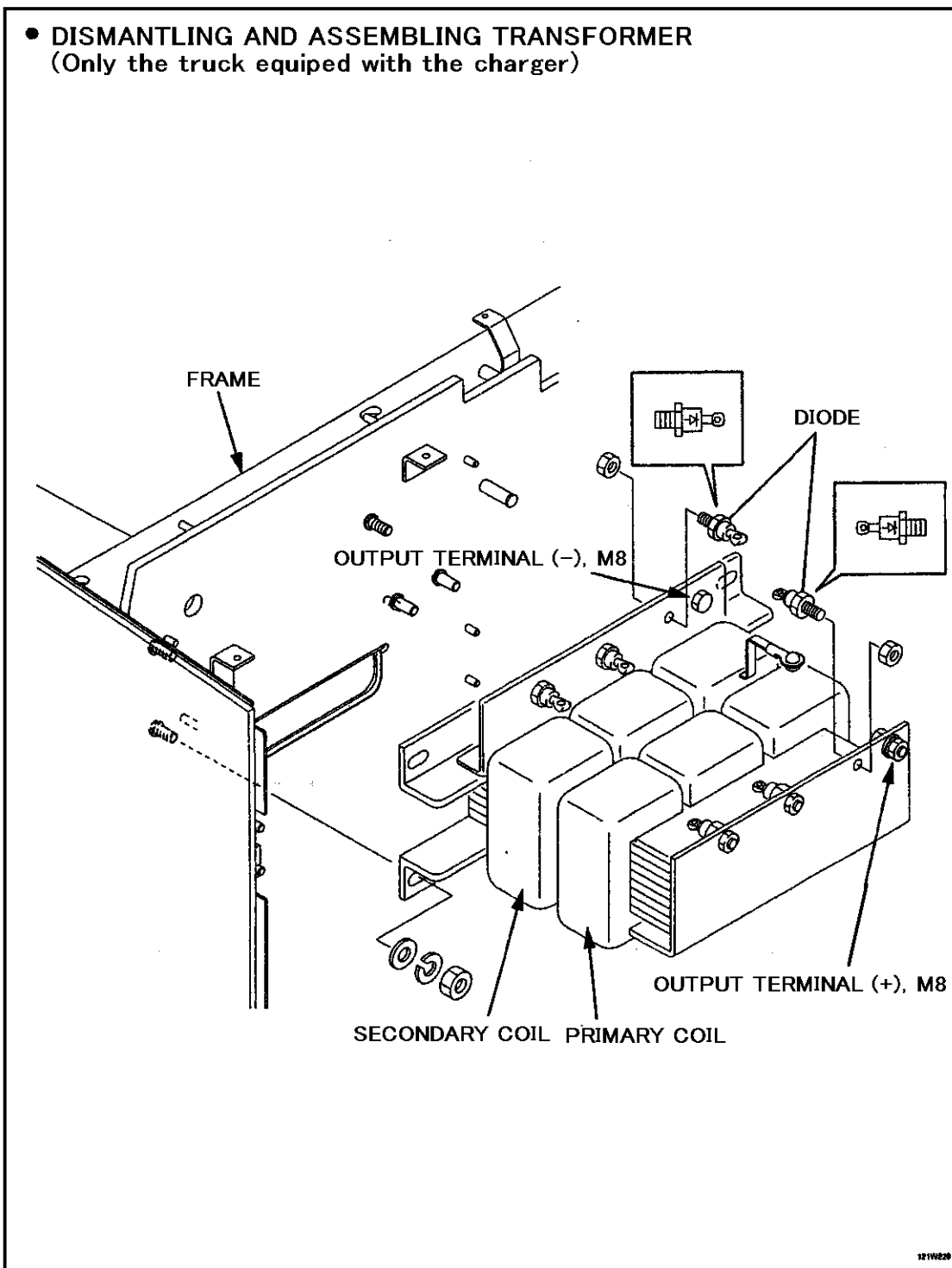

## 12-1-3. SPECIFICATION OF CHARGER

<200V series>

Battery capacity (All/5h)	Charger model (truck-mount type)	Capacity of power supply equipment	Capacity of fuses or breakers	Specification of power supply-side plug of charger cord	Applicable truck model
201 220 225	T0224-1017	3.0 kVA	15 A	Grounding 3P, 20A, 250V	FR10-7(H) FR13-7(H) FR10, 13-7C(H)
280 312	T0224-0328	4.3 kVA			FR14-7(H) FR15-7(H) FR18-7(H)
320 345 370	T0224-0329	5.2 kVA	20 A		FR20-7(H) FR25-7(H)
390 440 445	T1224-0317	6.4 kVA			

<400V series in option>

< STD >

			201	220	225
82A	FR10-7C	BAH	278A2-60171A	-	-
82B	FR10-7CH				
82C	FR13-7C	BAY	-60101	-	-
82E	FR13-7CH				
82W	FR9-7L	BAG	-60141	278A2-60241	-
82X	FR10-7L				
82Y	FR13-7L				
82F	FR10-7	BAH	278F2-60171A	-	278F2-60271A
82G	FR10-7H	BAY	-60101	-	-60201
82H	FR13-7	BAG	-60141	-	-60241
82J	FR13-7H				

			280	312	370
82K	FR14-7	BAH	278M2-60171A	278M2-60271A	278M2-60371A
82L	FR14-7H				
82M	FR15-7	BAY	-60101	-60201	-60301
82N	FR15-7H				
82P	FR18-7	BAG	-60141	-60241	-60341
82Q	FR18-7H				

			320	390	440	445
82R	FR20-7	BAH	282R2-60171	282R2-60271	282R2-60371	-
82S	FR20-7H					
82T	FR25-7	BAY	282R2-60101	-60201	-60301	-
82U	FR25-7H	BAG	282R2-60141	-60241	-	282R2-60341

## 12-2. INSPECTION AND REPLACEMENT

### 12-2-1. INSPECTION FOR MAGNET CONTACTOR

- ① Check the contact point for damage or burns.

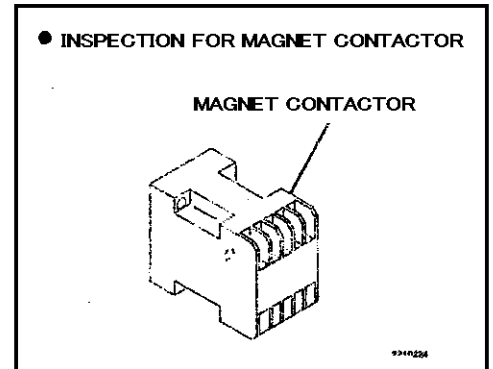

### 12-2-2. INSPECTION REPLACING PLUG SOCKET

- ① Check the plug socket for burns or discoloration.
- ➔ If there is something unusual, replace with both in set.
- ② Check for looseness of the mounting nut for earth terminal.

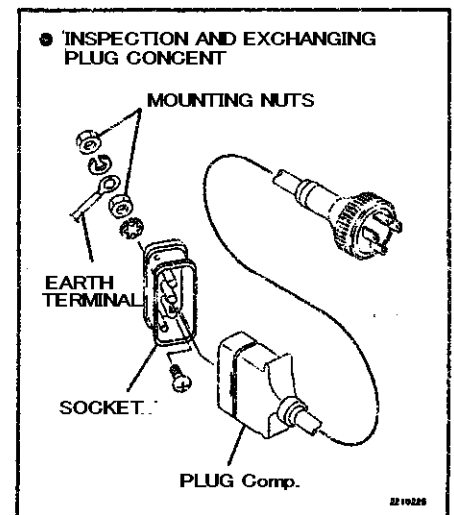

### 12-2-3. INSPECTION FOR FUSE WITH HOOK AND FUSE HOLDER

- ① Check for blowing the fuse or discoloration.
- ② Check for looseness of the screw for fuse holder.

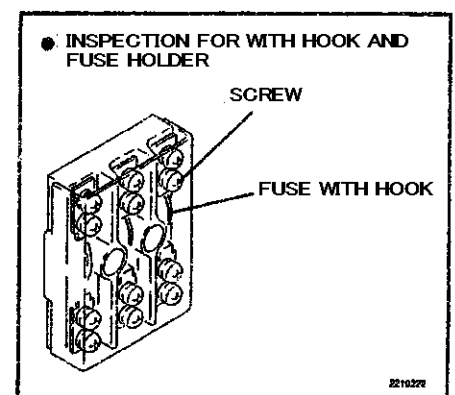

## 12-2-4. INSPECTION FOR TRANSFORMER

- ① Check for the damage and dirt.  
➔ If hard dirt is found, clean by compressed air.
- ② Measure the insulation resistance, and check.

STANDARD VALUE  
OF BREAK RESISTANCE

MORE THAN 5 MΩ

<How to measure>

### CAUTION

- Disconnect the battery plug before measuring.
- When you use the megger, never touch with measured terminals.

- ① Remove diode.
- ② Measuring the following point by megger.

- BETWEEN PRIMARY COIL AND SECONDARY COIL
- BETWEEN PRIMARY COIL AND CHASSIS
- BETWEEN SECONDARY COIL AND CHASSIS

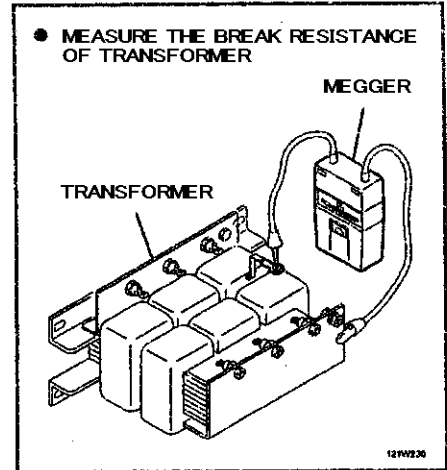

## 12-2-5. INSPECTION FOR DIODE

- ① Measure the resistance value, and check for normality of the diode circuit.

● STANDARD RESISTANCE VALUE

Terminal		Resistance value Ω
Plus side	Minus side	
Anode(A)	Kathode(K)	∞
Kathode(K)	Anode(A)	10-100 k

### NOTE

- The above values are just reference measured by digital tester (KAISE SK 7711).
- Each resistance value are subject to tester type.

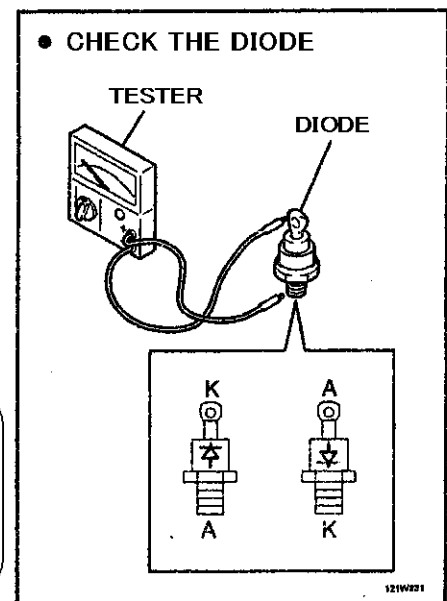

<How to measure >

- ① Adjust to set the range of resistance(Ω) × 1.
- ② With make a short circuited in tester sticks, adjust ditail to 0.
- ③ Apply the sticks to each point, and check for normality.

# 12-3. INSPECTION AFTER ASSEMBLED

**CAUTION**

- Make sure conductivity between earth terminal of plug socket and chassis body. (1Ω range of tester : 0Ω)
- The inspection should be done in well ventilated area and kept flames away.

## 12-3-1. INSPECTION FOR TIMER

<Total timer>

	How to check	MAGNET CONTACTOR	AUTO LED	RESERVE LED	EQUAL LED	CHARGE PASSED LED	
						1~2	3~4
1	Connect the battery plug	OFF	×	×	×	×	×
2	Connect the power plug into the poser socket	OFF	○	○	○	×	×
3	Press the "automatic charge button" for more than 5 seconds.	Just pressed	OFF	○	×	×	×
		After 5 seconds	ON	△	×	×	□
4	When the "AUTO LED" start blinking, you release "AUTO BUTTON".	OFF	△	×	×	□	□
5	Terminating the check after blinking "AUTO LED", it is after 1 minute 36 seconds.	OFF	×	×	×	△	△

- : LIGHT ON
- ×
- : SOMETIMES LIGHT ON
- △ : BLINKING

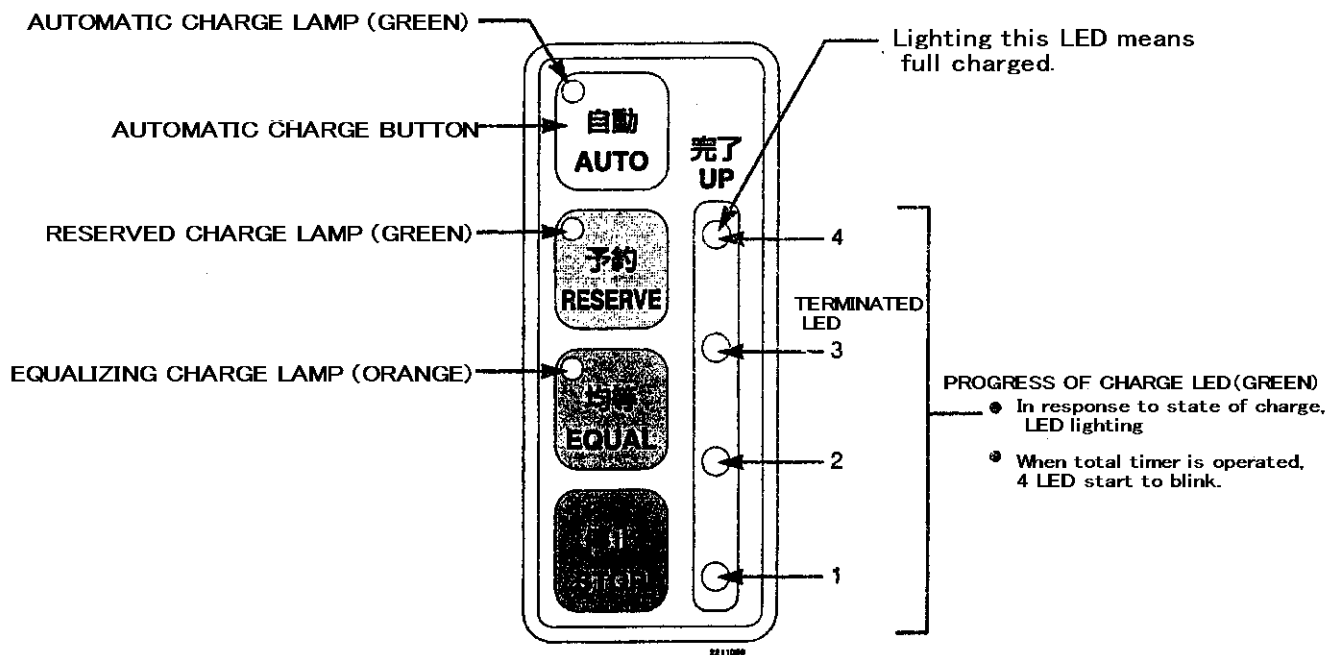

**CAUTION**

- In case of full charged battery use, checking the timer after operating hydraulics for few minute.
- In case of blinking "Progress of charge LED", it is continued until disconnecting the battery plug.



# 12-4. TRANSFORMER TAP CHANGING

## 12-4-1. CHECKING THE SUPPLY VOLTAGE

**NOTE**

- Measure the supply voltage of the facility without the charger operates.
- After measuring it for one minute, specify the highest measured value as the supply voltage.
- In case of 3 $\phi$  input source, measure the voltages between each phase (U-V, V-W, W-U) and specify the highest measured voltage in average as the supply voltage.

**CAUTION**

The measurement is done in recess of the facilities.

## 12-4-2. TAP CHANGING

<Case of input supply 200V>

Supply voltage (V)	Indication of tap
199 or less	200 V
200 - 209	210 V
210 - 219	220 V

<Case of input supply 400V>

Supply voltage (V)	Indication of tap
379 or less	380 V
380 - 399	400 V
400 - 419	420 V
420 - 439	440 V

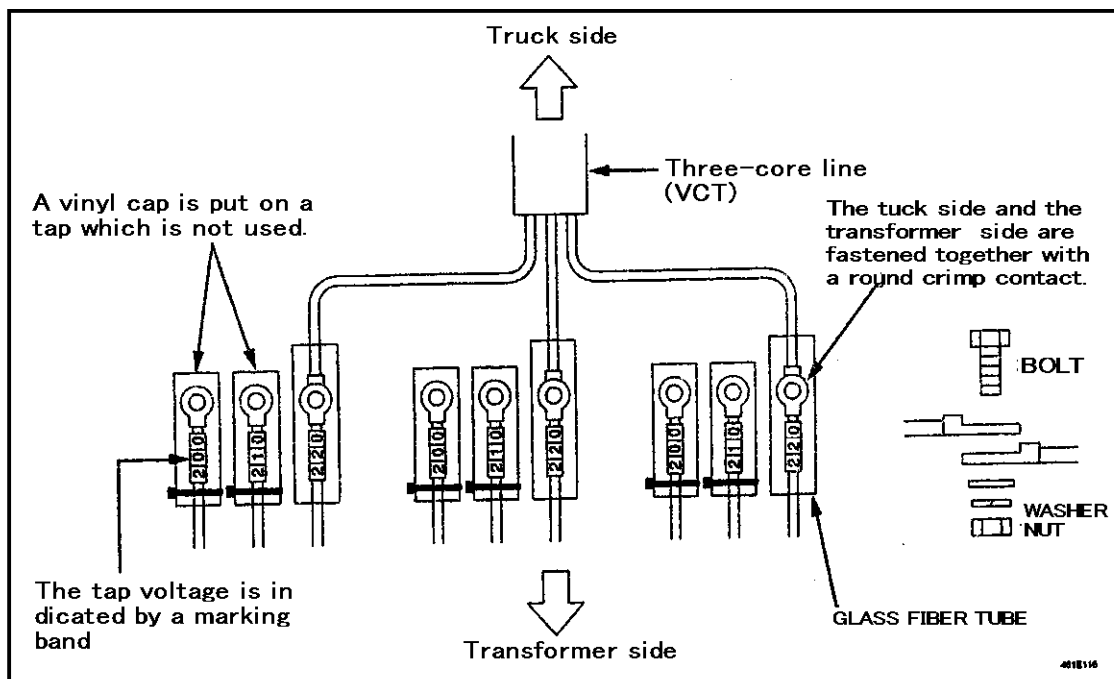
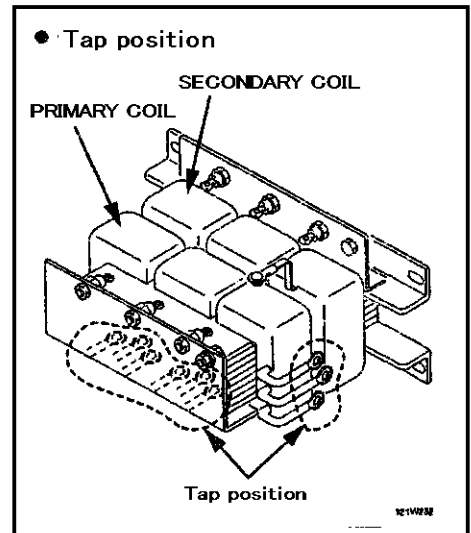

### 12-4-3. POINT OF TAP CHANGING

**CAUTION**

- Turn off the key switch, and pull out the power supply plug..
- Tighten screw enough.

- ① Loosen the screw, replading pressed circle terminal.
- ② Connect to condiemed tap for power supply voltage, tighten the pressed circle terminal.

- AT EX-FACTRY : 220V

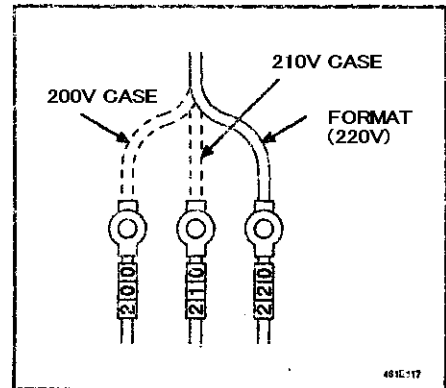

### 12-4-4. CHANGING THE FUSE WITH HOOK(3 φ VOLTAGE)

**CAUTION**

- Pull out the AC plug for power supply side.
- If plug not tight enough it may result is bad contact and will cause trouble.

- ① Loosen screw, and change fuse with hook.

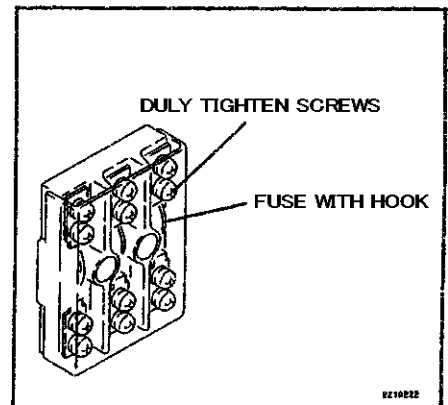



# FR-7 電気回路図

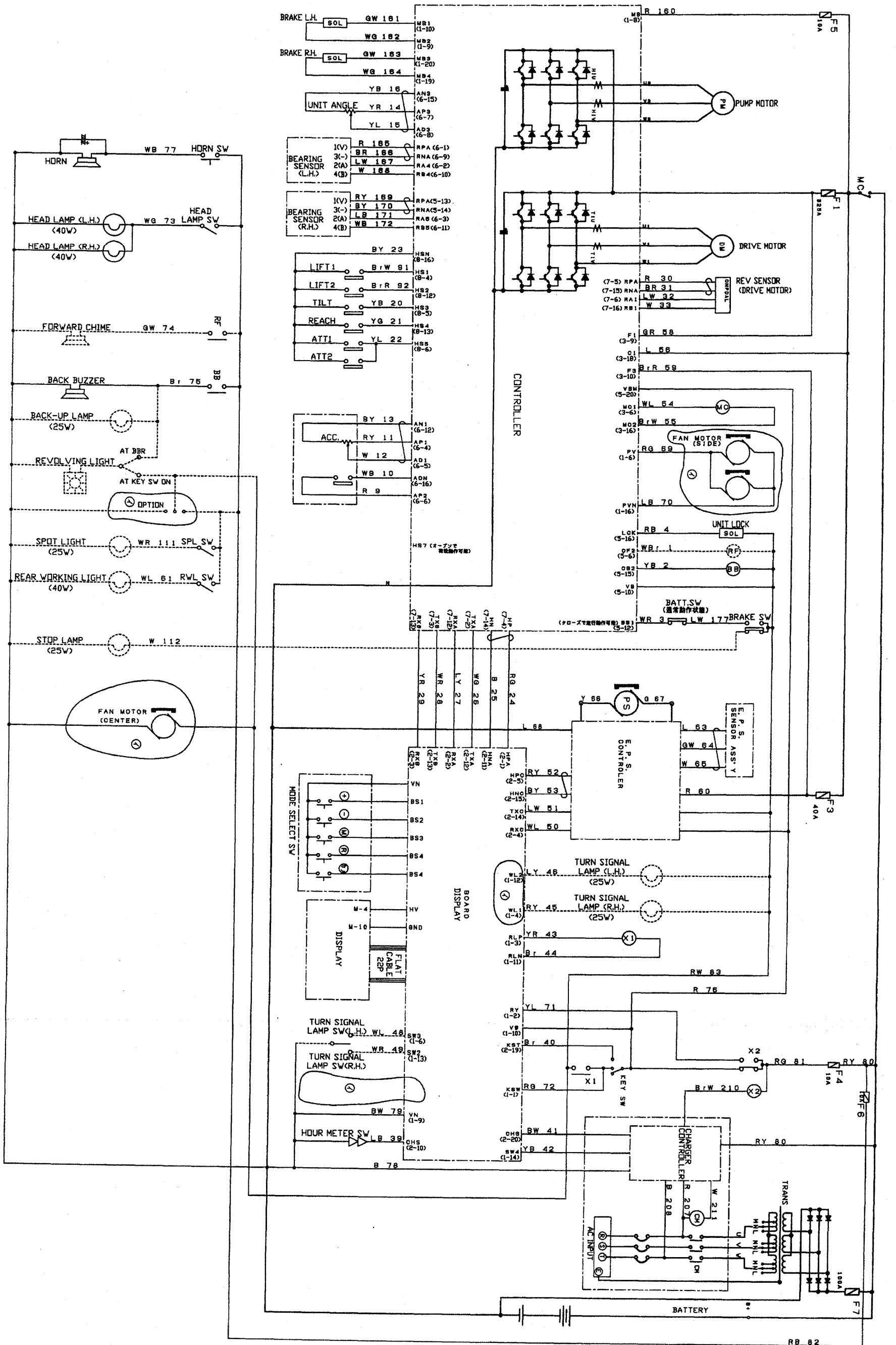

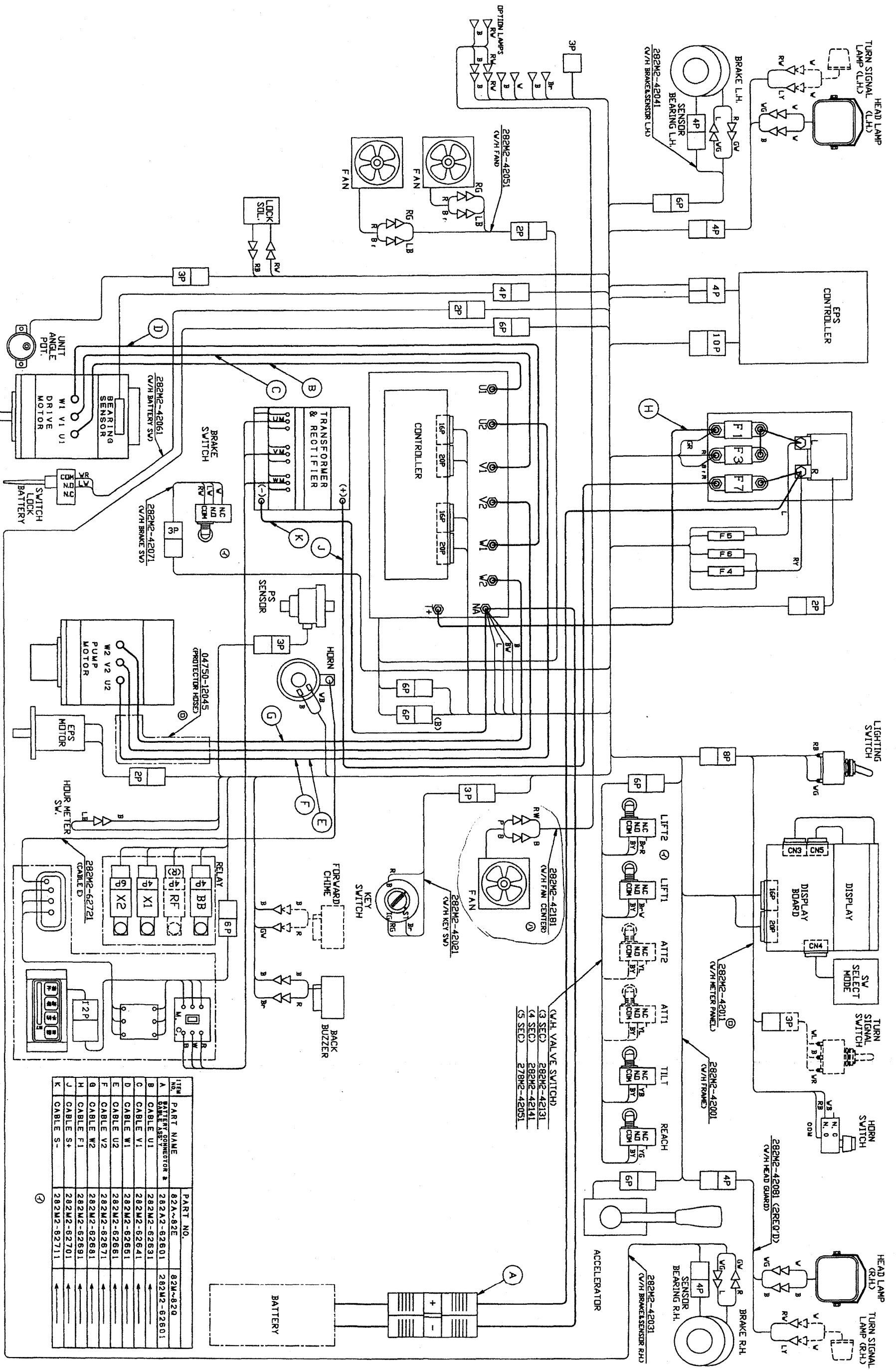

ITEM NO.	PART NAME	PART NO.
A	BATTERY CONNECTOR B	82A~82E
B	CABLE U1	282A2-62601
C	CABLE V1	282M2-62691
D	CABLE W1	282M2-62641
E	CABLE U2	282M2-62661
F	CABLE V2	282M2-62671
G	CABLE W2	282M2-62681
H	CABLE F1	282M2-62691
J	CABLE S+	282M2-62701
K	CABLE S-	282M2-62711

(V/H VALVE SWITCH)  
 (3 SEC) 282M2-42131  
 (4 SEC) 282M2-42141  
 (5 SEC) 278M2-42051

FR-7 電気配線図

## SPECIAL TOOL FOR REPLACING TRAIL WHEEL ON FR-7 SERIES

Front brake is provided on FR-7 series.

We suggest you to provide the special tool for replacing the Trail Wheel to introduce the below.

P/No : 99500 - 00969

APPLICABLE MODEL : FR 10-25 -7, -7H

<DETAIL>

IN SET	PULLER	1 PCE
	PULLER BOLT	1 PCE
	BOLT(M6 × 40)	2 PCS
	PUSHER A	1 PCE
	PUSHER B	1 PCE
	RING	1 PCE

