

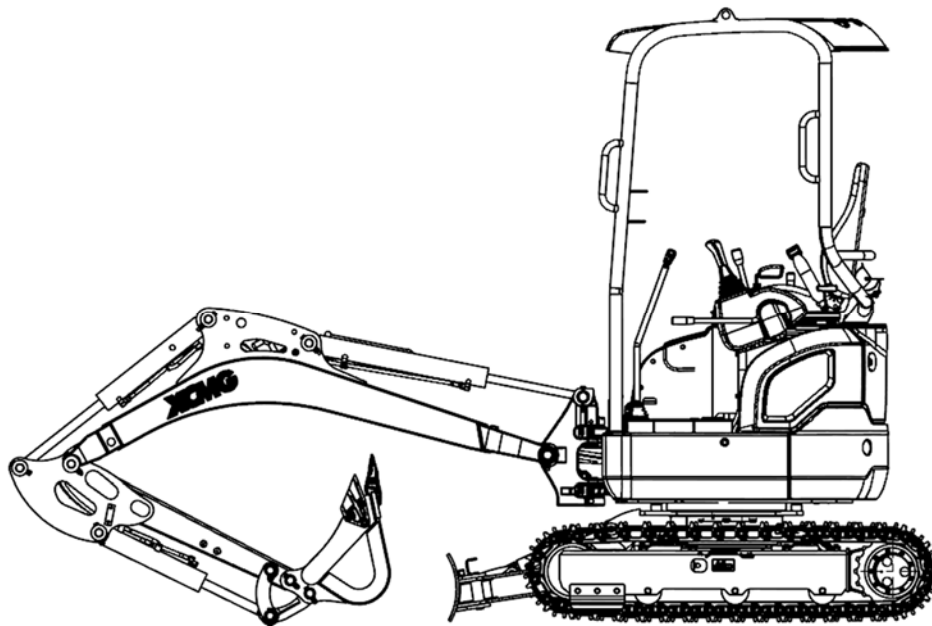

XUZHOU XCMG EXCAVATOR MACHINERY CO., LTD.

Hydraulic Excavator XE17U



Instructions Manual (EN)

Dear customer,

Please read and follow the instructions of this manual, and fill the informations of the machine in the table below. This is very important for us to support you.

Type:	
Year of manufacturing:	
Product identification number:	
Shipment date:	

This operation and maintenance manual apply only to the XCMG excavator XE17U, which complies with the following EC declaration of conformity.

XE17U – valid as of product identification number

Please contact your XCMG dealer for any additional information or troubleshooting procedures not mentioned in this operation and maintenance manual.

We would also like to point out that the contents of this operation and maintenance manual are not any previously existing agreement, commitment or legal relationship nor do they constitute an amendments. All responsibilities are taken from the respective sales contract, which contains the complete and exclusively valid contractual warranty, this documentation neither extends nor restricts the contractual warranty.

The overload warning system of the lifting operation is optional. If the machine is used for lifting, please contact your XCMG dealer, and confirm whether the system has been installed. If not, it is forbidden to use it for lifting. Otherwise, any accident occurred has no responsibility with XCMG.



EC Declaration of Conformity

Xuzhou XCMG Excavator Machinery Co., Ltd.

No.39 Gaoxin Road, Economic and Technological Development Zone, Xuzhou, Jiangsu 221004, P.R. China

Hereby declares that the product:

Product name: **XCMG Zero Tail Excavator**

Model: **XE17U**

Serial number (PIN):

Date of manufacture **Month / Year**

to which this declaration relates, is in conformity with the Essential Health and Safety Requirements of the Council Directives and Regulations and their Amendments related to machinery:

- EC Machinery Directive 2006/42/EC
- EMC Directive 2014/30/UE
- EC Noise Directive 2000/14/EC and subsequent amendments

Notified body: NB 0197-TÜV Rheinland LGA Products GmbH,

Tilly straÙe 2 90431 Nürnberg

Measured L_{WA} [dB(A)]: **92dB(A)**

Guaranteed L_{WA} [dB(A)]: **93dB(A)**

Engine Power [kW]: **11.8kW/2300(r/min) Stage V**

Conformity assessment procedure: Annex VIII Full Quality Assurance

Applied harmonized standards, in particular:

- EN 474-1: 2006+A5:2018 Earth-moving machinery – Safety
Part 1: General requirements
- EN 474-5:2006+A3:2013 Earth-moving machinery – Safety
Part 5: Requirements for hydraulic excavators
- EN ISO 13766-1:2018 Earth-moving and building construction machinery -
Electromagnetic compatibility (EMC) of machines with internal
electrical power supply-Part 1: General EMC requirements under
typical electromagnetic environmental conditions
- EN ISO 3744:1995 Acoustics - Determination of sound power levels
of noise sources using sound pressure -Engineering method in an
essentially free field over a reflecting plane

Declaration paper will be supplied with this manual by the dealer. If the declaration is missed, please contact with your dealer. Certificate number can be found in the website of NB 0197-TÜV Rheinland LGA Products GmbH.

Foreword

Xuzhou Construction Machinery Group Co., Ltd. (XCMG) has stood at the forefront of the Chinese construction machinery industry and developed into one of the domestic industries largest, most influential, and most competitive enterprise groups with the most complete product varieties and series. It is also one of the developers and rule makers for domestic industry standards and boasts industry leading product innovation capability and the most complete parts manufacturing Machine.

XCMG has integrated technological innovation and development to create a series of products which incorporate the most advanced technologies in China and around the world. Technological innovation has thus become XCMG's key to unlocking global markets.

XUZHOU XCMG EXCAVATOR MACHINERY CO., LTD., as the core pillar of **XCMG**, is a new "fist" enterprise that XCMG strives to build. It is committed to providing customers with the best solutions of construction machinery.

The product sales network covers more than 180 countries and regions. The annual sales revenue exceeds 10 billion yuan. It has become a leader in Chinese construction machinery industry and a strong competitor of international famous brands.

All this could not be achieved without worldwide customers, whose contributions are greatly appreciated. That is why we strive to maintain a strong customer relationship to improve even more in the future.

MARKETING AND SERVICE

XCMG European Sales and Services GmbH

Address: Europark Fichtenhain B4 47807 Krefeld Deutschland

Email: wangmenghan@xcmg.com

Fon: +4921518209351 Fax: +4921518209359

Web: www.xcmg.com

Imprint

Publisher	XUZHOU XCMG EXCAVATOR MACHINERY CO., LTD.
Date of Issue	20.02.2020
Version NO.	EOMEN17U-02
Copyright	XUZHOU XCMG EXCAVATOR MACHINERY CO., LTD.© This document may not be duplicated either in whole or as a reproduction in part to the third parties without the written approval of XUZHOU XCMG EXCAVATOR MACHINERY CO., LTD. All technical data, drawings, documentation and etc. are protected by copyright law.
Update	Data contained in this instruction meets the current state-of-the-art
Our company reserves the right to change the information, diagrams and specifications of this instruction for use at any time and without any notice.	

Table of Content:

1	User Guide	1
1.1	Key groups of users	1
1.2	Setup of User's Instructions	2
1.2.1	Safety Notes	2
1.2.2	Tips, Hints, Recommendations	2
1.2.3	Additional Signs and Formats	2
1.2.4	Additional Information	2
1.3	Product Description	3
1.3.1	Type-Plate	3
1.3.2	Declaration of Conformity	3
1.4	Intended Use	4
1.4.1	Intended Use of Machine	4
1.4.2	Special Modes of Operation	5
1.5	Limits of Application	5
1.5.1	Limitation factors of intended use	5
1.5.2	Space boundaries	6
1.5.3	Time related limits	6
1.5.4	Environment-related limits	6
1.6	Reasonably Foreseeable Misuse	7
2	Safety and Hazards	9
2.1	Responsible parties	9
2.2	Detailed tasks and responsibilities	10
2.2.1	The manufacturer	10
2.2.2	The owner	11
2.2.3	The operator	11
2.2.4	The Driver	12
2.2.5	The maintenance personnel (technician/engineer)	12
2.2.6	General requirements for all responsible parties	13
2.3	Personal Protection Equipment (PPE)	13
2.4	Hazards and Risks of Injury	14
2.4.1	Fire Risk and Explosion	14
2.4.2	Lightning Strike	16
2.4.3	Injury from Mechanical Parts	17
2.4.4	Hazards and Injuries from Hydraulic Devices	17
2.4.5	Risk of Burns	17
2.4.6	Chemical Burns	19
2.4.7	The Danger of Asbestos Dust	19
2.4.8	Poisoning and suffocation	19
2.4.9	Environmental Risk	20
2.5	Safety distance to overhead power lines above cabin	21
2.6	Safety distance to underground power lines/water supply	22
2.7	How to act in dangerous situations	24
2.7.1	The machine contacts with the power supply line	24

2.7.2	Fire.....	24
2.8	Safety Signs and Labels.....	26
2.8.1	Mandatory Signs.....	26
2.8.2	Prohibition Signs.....	27
2.8.3	Warning Signs.....	28
2.8.4	Rescue Signs.....	29
2.8.5	Fire Protection Signs.....	29
2.9	Machinery Specific Signs and Labels.....	30
2.9.1	Specifically Designed Warning Signs.....	30
2.9.2	Specific Designed Signs for Functions and Operation.....	33
3	Safe Operation of Machine.....	34
3.1	Safety for Children.....	34
3.2	Safety Rules.....	35
3.3	Pre-inspections and Safety.....	37
3.3.1	Inspection prior to engine start.....	37
3.3.2	Starting the Engine.....	38
3.3.3	Checks after starting the engine.....	39
3.4	Inspection before Operation.....	40
3.4.1	After starting the engine:.....	40
3.4.2	During machine operation.....	41
3.5	Machine Operation and Maintenance.....	42
3.5.1	Safety Rules for moving the Machine.....	42
3.5.2	Towing broken machines.....	45
3.5.3	Safety Rules for Lifting Load and Objects.....	45
3.6	Interchangeable Equipment (Optional Components).....	47
3.7	Safety Rules for Handling the Battery.....	50
3.7.1	Hazards involved with the battery:.....	50
3.7.2	Battery Switch.....	50
3.7.3	Starting the engine using auxiliary cables.....	52
3.8	Forbidden Operation.....	53
3.8.1	Location of Safety Signs on Machine.....	55
4	Machine Overview.....	57
4.1	Machine Arrangement.....	57
4.2	Machine Data.....	58
4.2.1	Overall Data.....	58
4.2.2	Working Range.....	59
4.3	Operating Conditions.....	60
4.4	Emissions.....	60
4.4.1	Noise Data.....	60
4.4.2	Vibration Data.....	60
4.5	Technical and Performance Data.....	63
4.5.1	Engine.....	63
4.5.2	Hydraulic System Data.....	63
4.5.3	Performance Parameter.....	63
4.6	Hydraulic Schematic Diagram.....	64

4.7	Electrical Schematic Diagram	65
4.8	Part identification and name plates	65
4.8.1	Nameplate – Serial Number.....	66
4.8.2	Engine.....	66
4.8.3	Hydraulic Travel Motor.....	66
4.8.4	Hydraulic Swing Motor	67
4.8.5	Hydraulic Pump	67
4.8.6	Frame	67
4.8.7	Boom	67
4.8.8	Arm	68
4.8.9	Bucket.....	68
4.9	Driver's Cab.....	69
4.9.1	Left travel control lever and pedal, right travel control lever and pedal.....	70
4.9.2	Right joystick.....	70
4.9.3	Dozer control lever.....	70
4.9.4	Auxiliary pressure port pedal “auxiliary pressure port specification”.....	70
4.9.5	Wheel track.....	71
4.9.6	Boom deflection pedal	71
4.9.7	Display and button unit	72
4.9.8	Engine starter switch.....	72
4.9.9	Operator's seat	72
4.9.10	Engine speed control lever	72
4.9.11	Left joystick	73
4.9.12	Safety lever	73
4.9.13	Monitor and switches (refer to section 5 for purpose during operation).....	74
4.9.14	Other electrical devices inside the cabin.....	78
4.9.15	Driver's Seat	79
4.9.16	Recommended use of machines	80
4.9.17	Safety lever	81
4.10	Crawler Type Selection and Applications.....	82
4.11	Hammer-Type Knapper (Optional) Application	83
4.11.1	Hammer-Style Knapper – Weight Data.....	83
4.11.2	Hammer-Style Knapper – Specifications	84
4.12	Working Loads – Operational Weight Data	85
5	Operation	86
5.1	Follow the rules regarding operating hours	86
5.2	Start and Shutdown.....	87
5.2.1	Engine Start	87
5.2.2	Warm-up of Hydraulic System	89
5.2.3	Shutdown.....	89
5.2.4	Jump-starting the excavator	91
5.3	Travel Operation.....	92
5.3.1	Overview of travel	92
5.3.2	Operating travel control lever.....	95
5.3.3	Travel speed control	95

5.4	Control Lever.....	97
5.4.1	Control Stand – Cabin Overview.....	97
5.4.2	Working Control.....	97
5.4.3	Dozer Lever Control Function.....	99
5.4.4	Boom Deflection Pedal.....	99
5.5	Operating the auxiliary port.....	100
5.5.1	Accessory Implement Switch.....	100
5.5.2	1-way and 2-way (combined function) setting of the auxiliary port 1.....	102
5.6	Control Display Functions.....	103
5.6.1	Icon Description.....	103
5.6.2	Key Function Description.....	104
5.6.3	Main interface.....	105
5.6.4	User Information Query.....	105
5.6.5	User Information Settings.....	107
5.6.6	System Settings.....	109
5.6.7	Help.....	111
5.7	Precautions measures for operating in risky situations.....	113
5.7.1	General risks during operation.....	113
5.7.1	Risks while working underwater.....	115
5.7.2	Risks when working on surfaces with poor bearing capacity.....	116
5.7.3	Risks while levelling or operating the dozer.....	117
5.7.4	Risks regarding the crawler.....	118
5.7.5	Risks when parking.....	119
5.7.6	Warning – Towing Operation.....	119
5.7.7	Risks when operating the hammer.....	120
5.7.8	Warning – Operation in Special Conditions.....	122
6	Maintenance.....	125
6.1	Safety during Maintenance.....	125
6.2	Inspection Checks before Starting.....	129
6.3	Installation for the accessories and other safety instructions.....	134
6.4	Lubrication and Repair.....	136
6.5	Maintenance Scheduels.....	137
6.5.1	Lubrication Period.....	137
6.5.2	Operator Maintenance checklist.....	140
6.6	Lubrication of equipment.....	141
6.6.1	New machine.....	141
6.6.2	Recommended oils.....	142
6.6.4	Lubrication Points.....	144
6.6.5	Connection points of equipment.....	145
6.7	Maintenance of Hydraulic System.....	147
6.7.1	Hydraulic Components.....	147
6.7.2	Hydraulic Oil – Oil Filter - Oil Change.....	148
6.8	Maintenance of Oil System.....	151
6.8.1	Replacement of engine oil and oil filter.....	151
6.9	Maintenance of Fuel System.....	153

6.9.1	Fuel Tank.....	153
6.9.2	Water Separator	153
6.9.3	Fuel Filter.....	155
6.10	Maintenance of Clean Air System.....	156
6.10.1	Air Cleaning Filter	156
6.11	Maintenance of Engine Cooling System	157
6.11.1	Coolant Level.....	157
6.11.2	Cleaning and Coolant Exchange	157
6.12	Electric and Control System	158
6.12.1	Battery	158
6.12.2	Electric Fuses	160
6.13	Bucket Maintenance.....	161
6.14	Traction Maintenance.....	163
6.14.1	Traction Operating Lever	163
6.14.2	Track Sag	163
6.14.3	Track Adjustment.....	164
6.15	Safety Seat-Belt	165
6.16	Bolt Tightening Torques	166
6.17	Hammer-Breaker Maintenance	168
6.18	Special Maintenance Conditions.....	169
6.19	Maintenance of Engine.....	169
7	Faults and Troubleshooting.....	170
7.1	Periodic Replacement of Parts.....	170
7.2	Engine	171
7.3	Electric System.....	176
7.4	Hydraulic System	179
8	Transport, Storage and Protection.....	182
8.1	Road transport.....	182
8.2	Loading.....	184
8.3	Transport.....	184
8.4	Unloading	185
8.5	Lifting the Machine	186
8.6	Storage and Protection.....	186
8.7	Use preparation after storage.....	187
9	Lift Capacity Calculation of the Excavator	188
9.1	Brief introduction and choosing the lift working condition:.....	188
9.2	Lifting attachment.....	189
9.3	Load suspension device.....	190
9.4	Calculation model and known specification.....	191
9.5	Table of lift capacity.....	192
10	Cleaning.....	194
10.1	Cleaning the system.....	194
11	Warranty	195

12	Decommissioning and disposal	196
12.1	Properly disassemble the unit	196
12.2	Disposal.....	196

1 User Guide

This instruction for use provides the safety guidance, correct use and maintenance of the machine and includes and summarise all important information. The operating instruction for use is made up of individual, serially numbered chapters. The table of contents shows how the individual chapters are structured.

- Before operating, maintaining or repairing the equipment, please
 - **read** carefully and master this instruction for use, and
 - **learn** how to correctly operate, maintain and repair your machine.
 - **note** the instruction for use safety information and safety signs attached to the machine, and
 - **understand** the safety requirements!

During operation and maintenance, you must always comply with all the precaution measures specified in this instruction for use.

Accidents are all mostly caused due to fail to comply with the basic safety rules of machine operation and maintenance.

The documentation supplied with the machine shall enable you to

- **operate** the machine in a safe way,
- **use it** in all allowed situations,
- **maintain/service** the machine within the required schedules
- **repair it** if necessary

To do this, you will have to learn the scope of documentation that is delivered in several parts and become familiar with the information and requirements contained in it.

The delivered documentation is compiled for the indicated serial number only.

It cannot be used for the same machine of the same series that has a different serial number.

The Operation and maintenance instruction for use is considered as a construction part of the machine.

To ensure the documentation is always complete, up to date and close to the respective machine:

- Do not remove individual pages from the instruction for use.
- Request any missing or uncomprehensive parts of the instruction for use from XCMG after sales service.
- Include new documents supplied as a result of modifications immediately.
- Replace obsolete versions of the instruction for use by the amended contents

1.1 Key groups of users

This Instructions are prepared for

- owners/operators and
- all users/drivers of hydraulic excavator XE17U.

Make the contents of this documentation available to all persons who operate or work with this model.

1.2 Setup of User's Instructions

1.2.1 Safety Notes

1.2.1.1 Setup of Safety Notes

Warning signs are structured as follows:

 Signal word (hazard's gravity)	<ol style="list-style-type: none">1. Kind and source of hazard2. Possible consequences of ignoring the warning3. Measures/precautions to take to avoid/prevent the hazard
--	---

1.2.1.2 Graduation of the Safety Notices

Safety notices vary with decreasing hazard gravity as follows:

 Danger!	Indicates an imminent danger that causes death or serious irreversible and inescapable injuries if not prevented.
--	---

 Warning!	Indicates a possible danger that may cause death or at least serious irreversible injuries if not avoided or prevented.
---	---

 Caution!	Indicates a possible danger that may cause moderate or light reversible injuries and/or considerable property or environmental damage if not avoided or prevented.
---	--

Notice	Indicates a possible situation that may cause property or environmental damage if ignored.
---------------	---

1.2.2 Tips, Hints, Recommendations

 *Provide the user tips, hints or recommendations for efficient handling of the product*

1.2.3 Additional Signs and Formats

1.2.3.1 Handling Instructions

Handling instructions are demanding you to undertake an activity or to perform a work step. Always carry out handling instructions step by step and in pre-defined sequence.

Handling instructions are structured as follows:

- Guideline for one instruction
- Result of action – if required

1.2.3.2 Lists

Not-numbered Lists are structured as follows:

- List-Level 1
 - List-Level 2

Numbered Lists are structure as follows:

1. List Level 1
2. List Level 1
 - 2.1. List-Level 2
 - 2.2. List-Level 2
 - 2.3. ...
3. (List level 1) ...

1.2.4 Additional Information

Illustrations only serve for additional or more detailed information and may differ from the actual product.

1.2.4.1 Images

Pictures and associated position numbers are given in bold in the text.

Position lines in an image end with:

- A dot, if they denote visible parts,
- An arrow when pointing towards invisible/indicated direction

Information such as left/right and front/rear refers to the seating position of the operator in the driver's cabin with the spraygun pointing backwards.

1.2.4.2 Dimensions

Dimensions are given in ISO units.

1.2.4.3 Applicable Documents

Pay attention to additional documents and relevant standards and legislation laws.

1.2.4.4 Accessibility

Make this manual, including the applicable documents, accessible to all persons working on the machine.

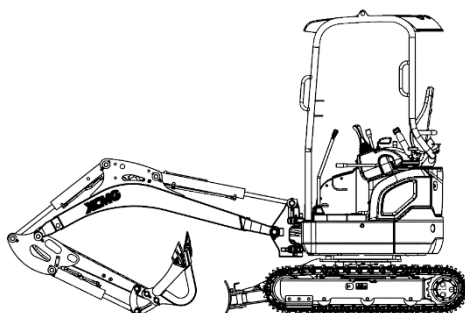

1.3 Product Description

This machine is a backhoe hydraulic crawler excavator with full swing and single bucket, which is widely used in urban and rural construction sites, like municipal constructions, irrigation and water conservancy and earth working constructions



1.3.1 Type-Plate

Model: _____
Rated power: _____
Operating weight: _____
Product identification No.: _____
Production date: _____

 HYDRAULIC EXCAVATOR	
MODEL	_____
RATED POWER	_____
OPERATING MASS	_____
PIN ON	_____
DATE OF MANUFACTURE	_____
XUZHOU XUGONG EXCAVATOR MACHINERY CO.,LTD. 	
ADD: No.39 Gaoxin Road, Economic Development Zone, Xuzhou City, 221000, P.R. China	

1.3.2 Declaration of Conformity

In accordance with guideline 2006/42/EU, the documentation must include the EU declaration of conformity when delivering this machine with a CE-label attached to it.

The EU declaration of conformity, in its present version and language, is valid in all countries of the European Union, as well as in countries that recognize the guideline 2006/42/EU.

Additional documents such as prototype testing reports or international testing approvals shall also be part of the technical documentation file.

The complete technical documentation must be archived by the manufacturer for at least 10 years after it has been placed on the market. It must be available at all times if required or requested.

1.4 Intended Use

Intended Use refers to the use of machinery in accordance with the information provided in the instruction for use (see European Machinery Directive 2006/42EC § 1.1.1 Definitions)

1.4.1 Intended Use of Machine

- The supplied equipment determines the possible applications of the machine.
- The machine is designed in accordance with ISO 474-1.
- The machine may only be operated in allowed setup condition and modes as provided in this operating and maintenance instruction for use.
- Any special machine tasks that deviate from the tasks described in this operating manual must be coordinated/verified with the machine manufacturer beforehand
- Any application that is not described in the operating and maintenance instruction for use must be authorized in writing by the manufacturer beforehand.
- Any divergent use without the manufacturer's written consent is considered as "non-intended use"
- **Intended use of any machine in accordance with the machinery guideline (2006/42/EU) is a basic requirement for safe operation.**

Non-observation of the intended machine use results in the following consequences:

- **Life-threatening or fatal injuries**
- **Severe damage to the machine**, the assets or **environmental contamination** for which the manufacturer cannot be held liable.
- **Loss of warranty and guarantee claims**

Intended use of the machine defines the following:

- Utilization limited only to the work areas and conditions of use listed and described in the instruction for use.
- Use of interchangeable equipment provided or approved by the machine manufacturer only.
- Moving the machine with care, be it with or without additional load, when interchangeable equipment is used. If necessary, ask a co-worker for supervisor
- A co-worker shall supervise the machine's moving within the allowed track in case of a maneuver on unsolid ground or if the operator is missing experience
- Lifting and lowering as well as carrying goods within the allowed load/amount with the prescribed interchangeable equipment.

Intended use requires the following:

- All safety devices to be installed and functioning properly
- All maintenance and repair work stated in the maintenance and inspection plan of the instruction for use must be performed according to the given specifications
- Only qualified maintenance personnel or authorized qualified personnel shall be involved.

- All safety instructions in this instruction for use must be observed during use
- All valid national and international safety regulations to be observed
- Only the operating materials listed in the instruction for use must be used
- All persons involved in the machine's operation must follow the safety instructions according to the instruction for use.
- All persons involved in the machine's operation must comply with their respective responsibilities according to the instruction for use.
- The technical information values and their limits must be taken into account.
- The Load charts and operating capacities must be respected.
- The machine must be operated only by using additional/interchangeable equipment that was approved by the manufacturer.
- The corresponding machine model and maximum loads must be taken into account

1.4.2 Special Modes of Operation

Special modes of operation:

- become the machine operator's sole responsibility, if they do not comply with the "intended use" defined by manufacturer
- may significantly reduce the machine's service lifespan
- may result in excessive stress on the machine, causing premature wearoff
- may result in undefined loading conditions with high dynamic stress, which may also lead to premature wearoff or damages

Special modes of operation include:

- Vibrator mode, hammer mode or quick coupler mode
- Vibrator lances/probes
- Installation of interchangeable equipment
- The use on floating constructions

1.5 Limits of Application

Defining the **machine's limits of application** is also required in the designated documentation parts in compliance with the DIN EN ISO 12100 standard and the Machinery Directive (2006/42/EG)

1.5.1 Limitation factors of intended use

- **Range of applications** in accordance to the operator's experience with and knowledge of the machine (industry, commerce, private, public sector)
- **Intended use** (refer to specifications in the instruction for use)

- **Predictable misuse**
- **Various steps within product lifecycle** (assembly, commissioning/delivery, set up, regular operation, cleaning, maintenance & servicing, appropriate disposal)
- **Operator's skills, experience and knowledge**
Operator, maintenance personnel in terms of training, experience, skills
- **Inexperienced/more vulnerable people**
 - Vulnerable groups (e.g. apprentices, pregnant women, volunteers, disabled persons with health conditions)
 - Collateral damages unrelated to the company (e.g. employees from other workplaces, visitors etc.)

1.5.2 Space boundaries

- Safety ranges/distances during movement/deployment
- Safety boundaries for people during installation and maintenance
- Material supply/removal
- Working places / area
- Interfaces

1.5.3 Time related limits

- Limits of the service period of the whole machine or specific components
- Recommended inspection, maintenance and repair intervals

1.5.4 Environment-related limits

- Environmental factors-related limits
e.g. restrictions within specific environmental conditions (weathering, altitude, slope steepness)
- Energetic limits
 - Types of energy
 - Interfaces supply/discharge
- Material limits
 - Interfaces supply/discharge
 - Starting materials, auxiliary operating materials, waste products

Information

- **Interfaces**
- **Inputs and expenses**
- **Higher-level control circuits**

1.6 Reasonably Foreseeable Misuse

"Reasonably foreseeable misuse" means the use of machinery in a way not prescribed in the instruction for use, but which may result from readily predictable human behaviors

This includes any undeclared application or type of misuse listed in the Machine Directive (2006/42/EG).

- The machine operator is responsible for all damages done to it due to "unintended use".
- Any use that is not described in this operating instruction for use is considered as "unintended use".

Use of the machine is assumed as **reasonable foreseeable misuse** in the following cases:

- Operating the machine without/with missing knowledge of the instruction for use
- Operating the machine without the required qualification or operating skills demanded by national regulations.
- Operating the machine if the instruction for use is missing, incomplete or not available in the contractually agreed language.
- Operating the machine by persons other than unauthorized operator
- Operating a machine that has not yet been properly tested in accordance with national or international directives and standards
- Operating the machine with incorrectly applied or malfunctioning safety installations or equipment. (e.g.: warning signals, emergency stop)
- Operating the machine in an unfavorable or hazardous environment according to specifications in the instruction for use (e.g: explosion hazard due to highly dense dust formation. Be sure to check the signification of all pictograms attached on facilities or machines in the area).
- Operation of the machine in an unapproved mode.
- Pulling or dragging a load on the ground.
- Expose the machine to physical quantities that exceed the limits prescribed by the manufacturer. (e.g. ambient temperature, ASL-altitude, carried load, wind speed, operating restrictions for inclined pull, soil slope inclination etc.)
- Install any spare part or interchangeable equipment not approved by the manufacturer
- Any kind of use or structural modification with the machine that endangers operational safety
- Performing repairs or maintenance not prescribed by the manufacturer
- Carrying out any structural modification on the machine or interchangeable equipment which may affect operational safety without the the manufacturer's written declaration of approval.
- Bypass or conversion of the required safety installations set in the factory.
- Operating the machine with open cabin door.
- Operating the machine when unauthorized personnel are standing on it or are present in its immediate vicinity.

- Transport of persons along with the load or with equipment not intended for this purpose.
- Lifting of persons with inadequate equipment or for unintended purposes
- Lifting of other devices on/beneath which persons are located.
- Lifting of loads attached to several lifting devices without considering the load limits defined in the instruction for use
- In excess of loads or with other components intended for this purpose.
- In excess of tools, rigging equipment or equipment parts (e.g. hammer equipment, piling equipment or dig)
- Using the machine in special modes not listed in the instruction for use, not approved by the manufacturer or without required modifications on the machine
- Tilting the machine above the limit angle
- Use of the machine on uneven, undulating, non-compacted, soft ground or ground not capable of bearing the rise in pressure
- Moving the machine without adequate vision, or without a supervising coworker in case of poor vision from the cabin
- Use of the machine as tractor (except for machines equipped with a towing attachment or drawbar eye) under observance of the admissible supported loads, trailing loads or trailer loads.
- Increasing the mass of already lifted loads unnecessarily
- Operating the machine in a different configuration than prescribed by the manufacturer (e.g. unfitting counterweights, boom components, reeving).
- Lifting of loads in emergency mode
- Lifting loads on the ground with other components/kinematics than the device intended for this purpose
- Operating the machine below ground (mining).
- Use of the machine for earth-moving work (e.g. leveling).
- Sea travel without observation of the specifications in the instruction for use.
- Installation of interchangeable equipment (e.g. hammer, vibrating drilling or tool) not previously agreed with the manufacturer.
- Initial start-up of machine.

2 Safety and Hazards

Safety instructions are provided to prevent personal injury or property and/or environment damage. This chapter deals with the following issues:

- Responsibilities of participants: users, operators, drivers, support and maintenance staff
- PPE
- Risk of injuries
- Safety

The following applies for the operators/users/drivers:

⇒ **Read and respect all safety instructions.**

2.1 Responsible parties

Definitions:

- **Manufacturer:** the producer of the unit/machine
- **Owner:** a proprietor of a business or a (set of) machine(s)
- **Operator:**
 - A person in charge of a specific project or machine, (→ **natural user, individual**)
 - Or a company that operates technical equipment, (→ **juristic user, entity**)
 - Or a company that generates sales merely through the distribution of machines. (→ **reseller** or **renter**)
- **User**
 - A company that uses bought or lent machines to manage a site job (→ **construction company**)
 - The worker(s) responsible for operating the machine (→ **driver**)
- **Driver:** the natural person(s) actually driving/operating the machine
- **Maintenance Personnel:** The natural person responsible for the machine's flawless functioning and all processes influencing it (repairs, maintenance, overhaul etc.)
- **User Personnel:** any natural person who is a member of a "juristic user" or "entity" as defined above

2.2 Detailed tasks and responsibilities

2.2.1 The manufacturer

- is responsible for the technical safety of the machine and its accessories.
- ensures operational readiness of the machine and its accessories
- supervises the product's performance in all periods of its life cycle
- supervises the maintenance and repair works carried out by authorized service personnel
- ensures the operational state of the unit via a worldwide maintenance and repair service
- provides training for the owner's operation and maintenance personnel as a service

2.2.2 The owner

- specifies the skills and responsibilities of personnel working with or nearby the machine
- provides only certified and authorized personnel for the operation and maintenance of the unit
- provides the necessary PPE to individuals working with the machine
- performs regularly verifications whether the personnel carries out their work in a safety-conscious manner
- is responsible for the safety state (smooth and safe functioning) of the machine and its accessories
- performs inspections on the machine based on national regulations in addition to the inspections defined by manufacturer's maintenance instruction for use
- informs the manufacturer of any accident involved in the machine leading to serious injury or major damage to property
- provides unrestricted access to the machine to manufacturer's authorized service personnel
- carries out the work planning for the machine carefully and conscientiously
- consults with the manufacturer or their authorized representative before making any modification to the machine
- uses original XCMG spare parts only – as given in the spare part lists

2.2.3 The operator

- ensures that only trained personnel operate or service the machine.
- checks qualification of persons working with or next to machine
- manages the activities of persons around the machine
- manages competencies/responsibilities of everyone working close to the machine
- determines persons which need steady supervision by an experienced co-worker or a superior
 - staff to be trained
 - staff being trained at the moment
 - personnel to be instructed
 - personnel in general education
- provides all persons next to machine with the necessary personnel protective equipment
- checks of the staff's safety-consciousness at work at regular intervals
- ensures the machine's safe-mannered operation according to intended use
- shuts the machine down immediately in case of safety-impairing defects
- performs on-time inspections on the machine according to XCMG maintenance schedule and as required by national authorities' guidelines
- reports every accident with the machine involved
 - serious injuries and/or
 - major property damage
- allows unrestricted access to the machine for XCMG-staff in accordance with the product observation duty.
- creates a task and duty roster for the machine and personnel
- clearly defines each personnel's responsibility (operation, set-up, maintenance and repair)
- ensures that no modifications to the machine is carried out without the manufacturer's approval
- uses original XCMG spare parts only
- always considers operating conditions, assesss possible hazards and acts accordingly
- takes suitable safety measures for the driver and bystanders

2.2.4 The Driver

- Has reached the legally required minimum age to operate the machine.
- Is physically able to safely operate the machine. This requires:
 - adequate eyesight
 - adequate hearing
 - quick reflexes
- Has the necessary authorization to operate the machine.
- Is able to accurately estimate distances, ASL-altitude and depths.
- Has the necessary training (theoretical and practical) for this machine type regarding:
 - operation
 - fastening/securing
 - instructing
 - using the fire extinguishing equipment
- Knows all escape routes and exits in case of an emergency.
- Is not subject to any physical or mental impairment that impedes any of the requirements.
- Is not under the influence of alcohol and/or drugs.

2.2.5 The maintenance personnel (technician/engineer)

- Must have knowledge of the operating instructions
- Must have knowledge of the supplied documentation, including
 - operating instructions of components
 - operating instructions from other manufacturers (e.g. interchangeable equipment)
 - data sheets
- Maintains the machine to ensure safe and reliable operation.
- Performs all prescribed maintenance activities.
- Must wear his PPE.
- Observes safety regulations at the place of use.
- Informs the operator of any safety-related changes/modifications on the machine.
- Performs modifications on the machine only after consulting the manufacturer.
- uses original XCMG spare parts only

Additional requirements for this position:

Qualifications and skills of the maintenance technician:

- Has reached the legally required minimum age to service the machine.
- Is physically able to reliably service the machine. This requires:
 - adequate eyesight
 - adequate hearing
 - quick reflexes
- Has the necessary authorization to maintain the machine.
- Is able to accurately estimate distances, altitude above sea level and depth.
- Has knowledge of the risks and hazards from the machine.
- Knows all procedures and precaution measures for maintenance.
- Has knowledge of handling maintenance equipment.
- Is not subject to any physical or mental impairment that impedes any of the prescribed requirements.
- Is not under the influence of alcohol and/or drugs.

2.2.6 General requirements for all responsible parties

The operating personnel needs to:

- Be physically and mentally suitable to operate the machine. This includes:
 - Good eyesight and hearing
 - Good spatial perception
 - Physical capacity
 - Good reflexes
 - Craftsmanship
- Be qualified by appropriate training and instructions for operating the machine.
- Be over 18 years old.
- Have passed the required health checks.

Persons with the following physical limitations are not, or only partially qualified to operate a machine if they follow a required special medical treatment:

- Epilepsy
- Fainting spells
- Heart attack risk
- Electrical/electromagnetic implants (e.g. pacemakers)
- Absent Limbs (e.g. missing fingers) if expected to impede the capability of operating the machine

Any responsible party should be committed:

- ➔ **To wear PPE** while working on a machine.
- ➔ **To make daily checks** the machine for damage before use
- ➔ **To operate** any machine **correctly**, which means according to parameters and intended use prescribed in this instruction for use
- ➔ **To notify** all responsible parties on any the safety related changes done to a machine.
- ➔ **To stop** work with a machine immediately if its safe operation is not guaranteed.
- ➔ **To clean and maintain** their PPE regularly to prevent faster wearout and increase safety at work.
- ➔ **To replace** any defective PPE-items immediately.

2.3 Personal Protection Equipment (PPE)

- ➔ **Wear PPE when working on any machine.**

PPE may include:

- Safety helmet, if head injuries are possible due to swinging, falling, or flying particles or pieces
- Safety eyeglasses when in contact with corrosive and pressurized liquids
loose parts and dust
- Respiratory protection/breathing masks in case of dangerous gases, vapour, smoke or dust in the working environment
- Hearing protection when working very close to the machine/on the platforms and roof
 - recommended also for a driver working with the windows open
 - must not reduce the driver's attention in communication with the environment
- Protective gloves
- Safety shoes
- Special protective clothing (to prevent burns, chemical burns, or cutting injuries in respected work places)
- Boldly-coloured or reflective clothing (when working at night or if recognition by other personnel is needed)



2.4 Hazards and Risks of Injury

- Before putting the machine into operation, check the following:
 - Machine indications and safety are not reporting any fault or warning
 - Driving machine work correctly
 - When loading the machine, make sure that nobody is coming under the lifted load.

During operation, observe the followings:

- Wear PPE (e.g. safety helmet, seat belt, etc.)
- Do not enter dangerous zones with the machine
- Do not reach into areas with moving machine parts (e.g. drive train of agitator, fan, etc.)
- Keep all hatches closed

2.4.1 Fire Risk and Explosion





	Warning
	<p>No fire, naked flames or electrostatic discharges! Danger of fire and danger of explosion due to easily flammable operating materials or gas mixtures resulting from these. ➤ Observe handling-specific and situation-specific safety notes.</p>
	<p>Improper handling of the machine in dusty environments (e.g. dust formation by unloading bulk goods)!</p> <ul style="list-style-type: none"> - Increased risk of fire. - Increased risk of dust-explosion - Make sure that the operator prevents dust formation through technical or organizational measures. - Shorten cleaning intervals and maintenance intervals.
	<p>➤ Observe the following safety notes:</p> <ul style="list-style-type: none"> - Keep a fire extinguisher ready - Make sure that the fire extinguisher is filled and ready for use - Know how to use the fire extinguisher in case of emergency. - Do not hang any transparent knickknack on the window glass. Because they are possible to focus the sun and cause a fire. - Ensure that the engine is free from inflammable deposits and soiling (oil buildup, leaves, pine needles, coal dust, waste) - Prior to refueling or filling with hydraulic fluid, shut down the machine and - Secure the engine/machine against unintentional restart! - When refueling via a tank supply line, make electrical compensation to avoid electrostatic charging between the machine and the refuel unit. - Immediately wipe spilled fuel off the machine with a suitable cloth. - In case that oil is spilled on the ground or floor, use the binder to collect it. - Dispose of any used binder safely and in an environmentally friendly manner. - After refueling, remove the fuel supply line from the machine and close the fuel tank again. - Only commission the machine as described in this operating instruction for use. - Do not use booster sprays containing ether-solvents to start the engine. - Do not store or use flammable liquids in the vicinity of the machine. - Do not use flammable cleaning agents to clean the machine. - Do not place flammable materials such as rags or clothing near the engine/electric motor. - Regularly check all protective covers, cables and wire brackets for completeness and tightness. - Ensure that loose cables or lines are firmly re-installed. - Check all hydraulic lines regularly (at least once a year) for damage and leaks. - Replace damaged hydraulic lines immediately. - Do not smoke near the battery. - Close the cover of ashtray to extinguish the match and cigarette butt - Ensure that there are no open flames or sources of ignition (eg electrical equipment) near the battery. - Check regularly the electrical machine of the machine by qualified personnel. - Watch for loose or damaged connections and cables. - During operation, store flammable and inflammable materials only in the required quantity close to the machine. - Do not store combustible and flammable materials in the vicinity of the machine - Do not store any flammable materials or carry them in the machine, only in fire-proof containers.

	<ul style="list-style-type: none"> - Wipe any spilled diesel fuel off the machine - Neutralise spillages on the ground with bonding agents - Do not clean the machine with flammable fluids. - Do not store any cleaning cloths in the engine compartment and remove flammable residues, e.g. oil spills, coal dust and paper residues. ➤ Only fuel up the machine in a well-ventilated place or ensure fresh air supply, - Make sure that there is good metallic contact between the pump nozzle and the filler neck during refueling. - If possible, ground the machine at the fuelling station while it is being refuelled. ➤ No open fire when handling flammable materials.
	<p>First Aid Measures</p> <ul style="list-style-type: none"> - Protection/personal safety <ul style="list-style-type: none"> • Identify - what kind of emergency? • Think - what dangers are there for the injured or helper? • Act - make the situation safe. - Emergency call - Emergency life-saving measures <ul style="list-style-type: none"> • Recovery position • Cardiac massage, artificial respiration and defibrillation • Staunch bleeding, shock prevention - Additional first aid



Explosion Hazards

- Before refueling or filling with hydraulic fluid, shut off the machine and secure against unintentional restart.
- When refueling via a tank supply line, make electrical compensation between the machine and the refueling machine.
- Immediately wipe spilled fuel off the machine with a suitable cloth.
- Immediately bind spilled fuel to substrate with binder.
- Dispose of used binder safely and in an environmentally friendly manner.
- Do not use booster sprays containing ether-solvents to start the engine.
- Do not store or use flammable liquids near the machine.
- Do not use flammable cleaning agents to clean the machine.
- Do not place flammable materials such as rags or clothing near the engine.
- Do not bring a lighter or matches in the cabin, as it/they may explode in case of rise of temperature



2.4.2 Lightning Strike

	Warning
	<p>Electric shock from lightning! Contact with a direct or indirect current flow caused by a voltage flash-over or step voltage can be fatal.</p> <ul style="list-style-type: none"> - Fall hazard when working at heights. - It can also cause a total loss of control, damage to the electronics or to local welding spots on supports, especially on the swing ring. <p>⇒ Observe handling-specific and situation-specific safety notes.</p>
	<p>Note: ⇒ Observe the following safety notes:</p> <ul style="list-style-type: none"> - Lay down the boom before a storm brake! - Do not operate the machine during a thunderstorm! - The closed operator's cabin acts as a Faraday cage. - The charge is channeled through the machine and into the ground <ul style="list-style-type: none"> - Always stay away from large, free-standing metal parts (e.g. machine) during a thunderstorm. - Machines without direct contact between steel structure and ground must be grounded. - Evacuate the cabin in the case of fire.
	<p>Measures after experienced storm strike:</p> <ul style="list-style-type: none"> - Check the electrical machine of the machine by qualified personnel - Thoroughly inspect the machine by paying attention to any damaged cable, hose or rope. - Check machine for leaks of fuels or supplies <p>Check the operational capability of the control machine.</p> <ul style="list-style-type: none"> - Slowly move the slewing gear and observe any unusual noise or behaviour. - Start to move the boom and buckle and observe any unusual noise or behaviour <p>Inspect the boom and buckle for damage. Contact XCMG for after-sales service.</p>
	<p>First Aid Measures</p> <ul style="list-style-type: none"> - Protection/personal safety <ul style="list-style-type: none"> • Identify - what kind of emergency? • Think - what dangers are there for the injured or helper? • Act - make the situation safe. - Emergency call - Emergency life-saving measures <ul style="list-style-type: none"> • Recovery position • Cardiac massage, artificial respiration and defibrillation • Staunch bleeding, shock prevention <p>Additional first aid</p>

2.4.3 Injury from Mechanical Parts



Warning	
	<p>Mechanical actions due to moving machinery! When operating the machine, numerous hazards and situations can arise that can cause life-threatening injuries.</p> <p>➔ Observe handling-specific and situation-specific safety notes.</p>
	<p>➔ Observe the following safety notes:</p> <ul style="list-style-type: none"> - Switch off the machine and power supply! - Wear suitable PPE. - Only work on non-moving parts. - Do not reach into areas with moving machine parts (eg. drive shafts, drive belt, fan, etc.). <p>Examples of mechanical impact:</p> <ul style="list-style-type: none"> - Standing under a suspended load. - Danger of being drawn in by moving drive units or machine parts. - Danger of falling when working without safety gear. - Danger of crushing due to unsecured components such as doors or sliding elements.
	<p>First Aid Measures</p> <ul style="list-style-type: none"> - Protection/personal safety <ul style="list-style-type: none"> • Identify - what kind of emergency? • Think - what dangers are there for the injured or helper? • Act - make the situation safe. - Emergency call - Emergency life-saving measures <ul style="list-style-type: none"> • Recovery position • Cardiac massage, artificial respiration and defibrillation • Staunch bleeding, shock prevention <p>Additional first aid</p>

2.4.4 Hazards and Injuries from Hydraulic Devices



Warning	
	<p>Escaping hydraulic oil under high pressure! Leakages in hydraulic lines can cause injuries to skin, destroy tissue and can cause blood poisoning due to the high pressures involved.</p> <p>➔ Observe handling-specific and situation-specific safety notes.</p>
	<p>➔ Observe the following safety notes:</p> <ul style="list-style-type: none"> - Repairs to hydraulic machines may only be carried out by qualified technicians with specialised knowledge and experience of hydraulics. - Make sure that the whole machine is pressure-free before start. - Never attempt to locate the leakage point with your hand or other parts of the body - Damaged hydraulic components must be replaced immediately with original XCMG spares - Check all hydraulic lines regularly (at least once a year) for damages and leaks - Replace damaged hydraulic lines immediately <p>➔ Examples of hydraulic energy:</p> <ul style="list-style-type: none"> - Tissue damage from leaks. - Sepsis from hydraulic oil entering bloodstream.
	<p>First Aid Measures</p> <ul style="list-style-type: none"> - Protection/personal safety <ul style="list-style-type: none"> • Identify - what kind of emergency? • Think - what dangers are there for the injured or helper? • Act - make the situation safe. - Emergency call - Emergency life-saving measures <ul style="list-style-type: none"> • Recovery position • Cardiac massage, artificial respiration and defibrillation • Staunch bleeding, shock prevention <p>Additional first aid</p>

2.4.5 Risk of Burns



Warning	
---------	--

	<p>Contact with hot surfaces and consumables! High surface and equipment temperatures can lead to burns or scalding. ➔ Observe handling-specific and situation-specific safety notes.</p>
	<p>➔ Observe the following safety notes:</p> <ul style="list-style-type: none"> - Always wear suitable protective gloves when working on hot components. - Only carry out work on the machine after it has cooled down and is stopped. <p>➔ Examples of burns and scalding:</p> <ul style="list-style-type: none"> - in contact with the entire drive machine. - on engine exhaust parts. - on hydraulic pumps or motors - on electric components - engine cooling radiator and pipes
	<p>First Aid Measures</p> <ul style="list-style-type: none"> - Protection/personal safety <ul style="list-style-type: none"> • Identify - what kind of emergency? • Think - what dangers are there for the injured or helper? • Act - make the situation safe. - Emergency call - Emergency life-saving measures <ul style="list-style-type: none"> • Recovery position • Cardiac massage, artificial respiration and defibrillation • Staunch bleeding, shock prevention <p>Additional first aid • Cardiac massage, artificial respiration and defibrillation • Staunch bleeding, shock prevention</p> <p>➔ Additional first aid:</p> <p>First degree burns (reddening of skin):</p> <ul style="list-style-type: none"> - Cool the affected body part by rinsing with cold fresh water. - Gently cover injured area(s) with a sterile anti-bacterial bandage. <p>Second degree burns (blistering of skin):</p> <ul style="list-style-type: none"> - the affected body part by rinsing with cold fresh water. - Gently cover the area using a sterile anti-bacterial bandage. - Do not apply pressure. <p>Third degree burns (charring of skin and tissue):</p> <ul style="list-style-type: none"> - Gently cover the area using a sterile anti-bacterial bandage. Do not apply pressure!

2.4.6 Chemical Burns



Warning	
	<p>Contact with corrosive and chemical consumables! Acids and bases cause chemical burns to skin and tissue, and blindness if they come in contact with the eyes. Acids and bases will damage clothing. ➔ Observe handling-specific and situation-specific safety notes.</p>
	<p>➔ Observe the following safety notes:</p> <ul style="list-style-type: none"> - Replace damaged battery immediately. - Wear safety goggles and protective gloves when replacing battery. - Wear safety goggles and protective gloves when working on the battery. - Do not smoke near the battery. - Ensure that there are no open flames or sources of ignition (e.g. electrical equipment) near the battery. - Do not short connect the battery terminals. - Do not place conductive materials on the battery. - Replace discharged battery immediately or charge battery in heated area <p>➔ Examples of chemical burns:</p> <ul style="list-style-type: none"> - Chemical burns from handling acidic consumables. - Chemical burns from leaking battery acid.
	<p>First Aid Measures</p> <ol style="list-style-type: none"> 1. Protection/personal safety <ul style="list-style-type: none"> • Identify - what kind of emergency? • Think - what dangers are there for the injured or helper? • Act - make the situation safe. 2. Emergency call 3. Emergency life-saving measures <ul style="list-style-type: none"> • Recovery position • Cardiac massage, artificial respiration and defibrillation • Staunch bleeding, shock prevention <p>Additional first aid</p>

2.4.7 The Danger of Asbestos Dust



Warning	
	<p>Contact with the asbestos dust! If too much asbestos dust in the air is breathed, it is possible to suffer a lung cancer. ➔ Observe handling-specific and situation-specific safety notes.</p>
	<p>➔ Observe the following safety notes:</p> <ul style="list-style-type: none"> - Use the dust filtering masks, when there is asbestos dust in the air - Follow the rules, regulations and the environment standard in the work place. - Do not be allowed to close to the machine for other personnel during operation. - Operate the machine in the upwind position If there is asbestos dust in the air. - Do not use the compressed air to reduce the dust.
	<p>First Aid Measures</p> <ol style="list-style-type: none"> 1. Protection/personal safety <ul style="list-style-type: none"> • Identify - what kind of emergency? • Think - what dangers are there for the injured or helper? • Act - make the situation safe. 2. Emergency call 3. Emergency life-saving measures <ul style="list-style-type: none"> • Recovery position • Cardiac massage, artificial respiration and defibrillation • Staunch bleeding, shock prevention <p>Additional first aid</p>

2.4.8 Poisoning and suffocation

Warning	
---------	--

	<p>Inadequate ventilation or fresh air!</p> <ul style="list-style-type: none"> - Poisonous vapours or other atmospheres hazardous to health can lead to poisoning or suffocation. <p>⇒ Observe handling-specific and situation-specific safety notes.</p>
	<p>⇒ Observe the following safety notes:</p> <ul style="list-style-type: none"> - Only operate machine in well-ventilated areas - Ensure adequate ventilation in the cabin. - Use breathing apparatus when working with hazardous materials. - Regularly replace filter of respiratory mask <p>⇒ Examples of intoxication and choking:</p> <ul style="list-style-type: none"> - Engine exhaust gases contain carbon monoxide and other hazardous gases. - Machine is used in areas where hazardous substances are present, and contact with hazardous gases is a possibility. - The refrigerant from the air conditioning machine circuit displaces the oxygen in the air.
	<p>First Aid Measures</p> <ol style="list-style-type: none"> 1. Protection/personal safety <ul style="list-style-type: none"> • Identify - what kind of emergency? • Think - what dangers are there for the injured or helper? • Act - make the situation safe. 2. Emergency call 3. Emergency life-saving measures <ul style="list-style-type: none"> • Recovery position • Cardiac massage, artificial respiration and defibrillation • Staunch bleeding, shock prevention <p>Additional first aid</p>

2.4.9 Environmental Risk

Warning	
	<ul style="list-style-type: none"> ⇒ Risk of damage to the environment caused by pollutants! ⇒ If their release is not controlled, fuels, oils, cleaning agents, coolant, etc. can enter the ground or rivers and cause environmental damage. ⇒ Observe handling-specific and situation-specific safety notes
	<p>⇒ Observe the following safety notes:</p> <ul style="list-style-type: none"> ⇒ In the event of leakage of fuel or operating consumables, rectify the causes immediately. ⇒ Eliminate leaking fuels or operating materials immediately with binders. ⇒ Dispose of used binder safely and in an environmentally friendly manner. ⇒ When disposing of fuels or operating materials, observe national disposal regulations. ⇒ If necessary, clarify the disposal with the local authorities. ⇒ Use a suitable container when draining fuels or fluids. Sump is sufficiently large, dense and chemically resistant to the corresponding fuel or hydraulic oil. ⇒ Do not mix fuels or operating consumables when draining. ⇒ Store or dispose of fuel or operating consumables separately. <p>⇒ Examples of hydraulic energy:</p> <ul style="list-style-type: none"> - Leakages in the operating machines. - Refilling consumables incorrectly.
	<p>First Aid</p> <p>Notify the emergency services/authorities of any large amounts leaks of environment endangering substances!</p>

2.5 Safety distance to overhead power lines above cabin

- Treat the overhead power lines as live until shutoff has been confirmed in writing by the responsible authority.
- Pay attention to distances between overhead lines and spray beam.
Break off if in doubt.

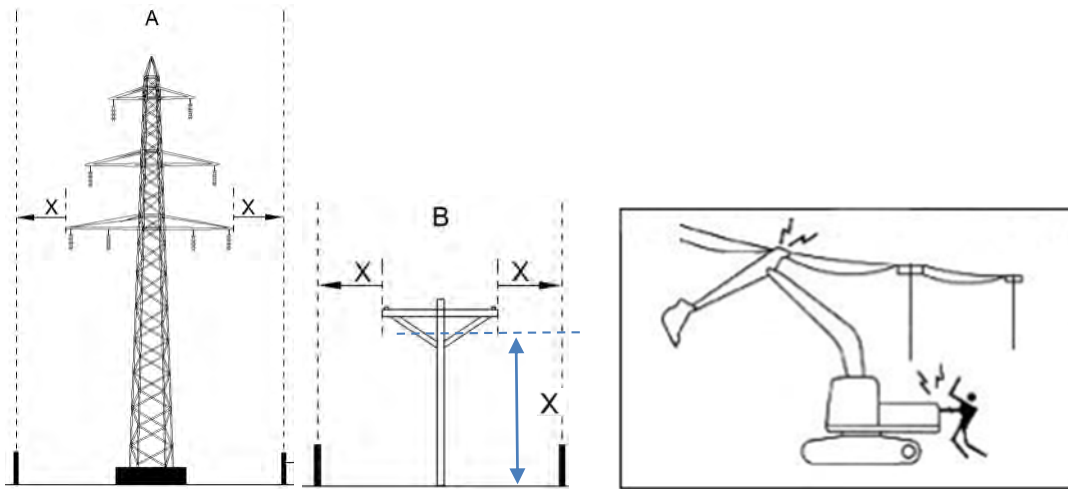





Fig. Overhead Power Line types

- (A) High Voltage Supply Lines
- (B) Low and Medium Voltage Supply Lines

2.6 Safety distance to underground power lines/water supply

- Start working only after explicit approval or confirmation of the shutoff of the underground power supply lines by the responsible authority.
- Treat the underground power lines as live until shutoff has been confirmed in writing by the responsible authority.
- Pay attention to distances between underground supply lines and working position.
- If necessary, consult a second person for observation.
- Break off if in doubt.

Warning										
	<ul style="list-style-type: none"> ➤ Electrical energy and fire hazard! ➤ Coming into contact with a direct or an indirect current flow caused by a voltage flash-over or step voltage can be fatal. 									
	<p>Observe the following safety notes:</p> <ul style="list-style-type: none"> - Start working only after explicit approval or confirmation of the shutoff of the overhead power lines by the responsible authority. - Treat the overhead power lines as live until shutoff has been confirmed in writing by the responsible authority. - Pay attention to distances between overhead lines and spray beam. - If necessary, consult a second person for observation. - Break off if in doubt. <p>➤ Examples of hydraulic energy:</p> <ul style="list-style-type: none"> - Coming into direct contact with an overhead power line. - If the safety distance is not maintained, an arc will form. - An overhead power line comes down and a dangerous resistance area forms in the ground around it. <p>The safety machines of the different national electricity grids react differently in the event of a fault. One may not assume that the overhead power lines will be automatically and permanently shut down after a short to earth. A resistance area develops around the machine and/or the damaged overhead power lines</p>									
	<p>The necessary safety distance depends on the rated main voltage of the power lines.</p> <ul style="list-style-type: none"> - Safety distances to overhead power lines are listed exemplary in ISO 12480-1 and OSHA Part 1926. - These are benchmark values. - The respective nationally prescribed safety distances must be observed. - Exact information on nominal line voltage is provided by the power supply company. <p>Safety distances "X" : ISO 12480-1 Cranes - Safe use (B) Low Voltage : (B) Medium Voltage: Safe Distance X = 3000 mm (A) High Voltage: X = 6000 mm</p> <p>Safety distances "X": USA- Occupational Safety and Health Administration OSHA Part 1926. 1408 and 1926. 1409) Nominal line voltage: <u>up to 350 kV</u> => Safe distance X = 6100 mm <u>above 350 kV</u> X = 15250 mm</p> <table border="1" style="width: 100%; border-collapse: collapse;"> <thead> <tr> <th style="width: 30%;"></th> <th style="width: 30%;">Voltage</th> <th style="width: 40%;">Minimum Safe Distance</th> </tr> </thead> <tbody> <tr> <td style="text-align: center;">Low Voltage</td> <td style="text-align: center;">100V,200V</td> <td style="text-align: center;">2.0m</td> </tr> <tr> <td style="text-align: center;">High Voltage</td> <td style="text-align: center;">6.6 KV</td> <td style="text-align: center;">2.0m</td> </tr> </tbody> </table>		Voltage	Minimum Safe Distance	Low Voltage	100V,200V	2.0m	High Voltage	6.6 KV	2.0m
	Voltage	Minimum Safe Distance								
Low Voltage	100V,200V	2.0m								
High Voltage	6.6 KV	2.0m								

		22 KV	3.0m
		66 KV	4.0m
		154 KV	5.0m
		187 KV	6.0m
		275 KV	7.0m
		500 KV	11.0m



First Aid Measures

1. Protection/personal safety
 - Identify - what kind of emergency?
 - Think - what dangers are there for the injured or helper?
 - Act - make the situation safe.
2. Emergency call
3. Emergency life-saving measures
 - Recovery position
 - Cardiac massage, artificial respiration and defibrillation
 - Staunch bleeding, shock prevention
4. Additional first aid
 - **Staunch bleeding, shock prevention**





Additional first aid

2.7 How to act in dangerous situations



In the event that current is conducted to the machine from coming into contact with a power line, the current is distributed from the point of entry in the earth.









The voltage decreases according to a funnel-shaped curve - a resistance area is formed.

2.7.1 The machine contacts with the power supply line

	<p>First response</p> <ul style="list-style-type: none"> - Remain calm. - Alert the relevant power supply company. - Do not leave the cabin: <ul style="list-style-type: none"> • Remaining in the closed cabin is relatively safe as it acts as a Faraday cage. • Only evacuate the cabin in case of fire. - If the control machine is still functioning: <ul style="list-style-type: none"> • Move the machine out of the danger area. - Remain in the cabin until current is no longer being conducted through the machine.
	<p>Leaving the machine</p> <ul style="list-style-type: none"> - Never touch the machine's live parts (ropes, load, crawlers, etc) when touching the ground. - Jump in a direction that avoids any contact with live parts. - Jump to a safe distance from the machine and land on both feet at the same time. - Land on both feet at the same time with legs closed (do not straddle). - Never hold on to the machine or any live parts. - Jump away on both feet with both legs pressed together. - While jumping away, keep well clear of any live parts.
	<ol style="list-style-type: none"> 1. First Aid 2. Alert emergency services 3. Leave the personnel rescue to the professionals!
	<p>Assure medical attention after electrical accidents. The person affected may experience symptoms of an irregular heartbeat some time after the accident.</p>

2.7.2 Fire

	<p>First response</p> <ul style="list-style-type: none"> - Incorrect behavior in case of fire - Danger of backlash! - Even if the fire appears to be extinguished, leaking fuel or oil coming in contact with hot components may reignite - Shut off the engine. - Alert the emergency services. - Move people out of the danger zone, - Perform first aid if required - Only start to fight the fire if there is no risk to your personal safety.
	<p>Fire Fighting</p> <ul style="list-style-type: none"> - Fire Classes Requirements: <ul style="list-style-type: none"> - Appropriate extinguishers must be used! - If unsuitable extinguishers are used, they may be ineffective or even lead to additional hazards. - Use extinguishers matching the fire class/combusted material (see symbols on the left) <ul style="list-style-type: none"> • A = Solid organic materials • B = Liquids and liquefying materials • C = Gases and other vapors • D = Metals

     	<ul style="list-style-type: none"> - Fire extinguishers are subject to national regulations! - Take fire extinguishers on the machine off the holders - Make it ready for operation. - Fight the source of the fire with several short bursts. - While fighting the fire, ask personnel to alert the fire brigade. <p>First Aid</p> <ol style="list-style-type: none"> 1. Alert emergency services 2. Only experts rescue the personnel!
	<p>Assure medical attention after electrical accidents. The person affected may experience symptoms of an irregular heartbeat some time after the accident.</p>
	<p>A “prohibition sign” means a safety sign prohibiting behaviour likely to cause a risk to health or safety.</p>

2.8 Safety Signs and Labels











- Make sure to understand all safety signs contained in this instruction for use and the safety symbols related to the machine.
- Keep safety signs clean, undamaged and readable.
- If any safety sign is missing/damaged, contact **Xuzhou XCMG Excavator Machinery Co. Ltd.** immediately to have them replaced.
- Do not hesitate to contact an **XCMG agent** for any other ambiguity or issue as well

2.8.1 Mandatory Signs

General mandatory action signs



Common mandatory signs

Description	Mandatory Signs		Description
Wear ear protection			Wear eye protection
Wear safety footwear			Wear protective gloves
Wear protective clothing			Wear a face shield
Wear head protection			Wear a safety harness
Wear safety belts			Read operating instruction for use

2.8.2 Prohibition Signs



A “prohibition sign” means a safety sign prohibiting behaviour likely to cause a risk to health or safety.

Common prohibition signs

Description	Prohibition Signs		Description
Smoking forbidden			Fire, open ignition sources and smoking are forbidden
Pedestrians forbidden			Forbidden for ground conveyors
Access for persons with pacemakers or implanted defibrillators forbidden			No access for unauthorized personnel
Entering the area forbidden			Switching forbidden
Do not lift load			No climbing for unauthorized personnel
Transport of persons forbidden			High-pressure cleaning forbidden

2.8.3 Warning Signs





Warning signs indicate risks or hazards (ISO 7010)

Common warning signs

Description	Warning Sign		Description
Warning of non-ionizing radiation			Warning of obstacles on the ground
Warning of fall hazard			Warning of slipping hazard
Warning of electric voltage			Warning of suspended loads
Warning of hot surfaces			Warning of automatic start
Warning of crushing hazard			Warning of crushing hazard when falling
Warning of hand injuries			Warning of counter-rotating rollers
Warning against staying the swing range			Warning of crushing hazard from above
Warning of crushing hazard from above			Warning of getting rolled over
Warning of getting rolled over			Warning of getting drawn into winches
Warning of dangers through pressure container			Warning of hazards through battery charging
Warning of dangers through hydraulic oil			Refer to instruction for use

2.8.4 Rescue Signs

Rescue signs mark the locations of first aid equipment and emergency exits.

Description	Rescue sign	Description
First aid		Place where to find a first aid kit or similar
Emergency exit (door)		Door useable to exit in case of emergency (alarm may turn on when opened; do not misuse)
Emergency exit (window)		Window to escape in case of emergency. Use the mallet/hammer nearby to smash open

2.8.5 Fire Protection Signs









Fire protection signs mark the location of fire alarms or fire extinguishing equipment





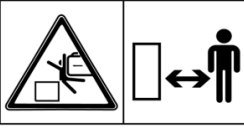

Common fire protection signs

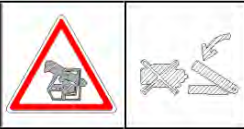



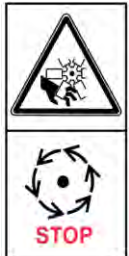

Description	Fire protection Sign		Description
Fire extinguisher			Fire detector

2.9 Machinery Specific Signs and Labels



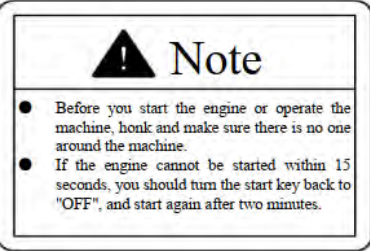

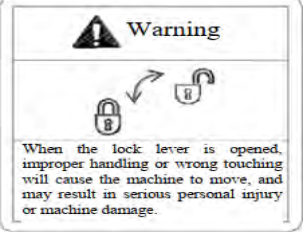

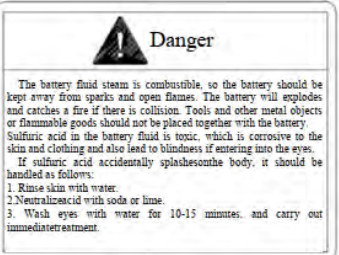
2.9.1 Specifically Designed Warning Signs

Sign Design	Sign Description
	Danger! - high voltage Bringing the machine too close to power supply lines may cause electric shocks Keep it at a safe distance from power lines when operating/driving a machine
	Warning! - risk of injury due to improper window fixing Opening the front window may result in falling out of the machine Be sure to lock the windows properly with designated pins when opening them up.
	Mandatory sign stating “wearing safety belts while driving/operating machines” Ignoring it may result in serious, irreversible injuries or even death Observe basic safety precaution for machine drivers
	Warning sign stating “securing procedure before leaving the machine” Ignoring the securing procedure may result in extrusions or rolling down when the parked machine is moved unintentionally. Before leaving the machine, make sure to: lower the machine’s boom down to the ground, move the safety lever to the lock position, remove the engine key
	Warning sign stating “how to exit the cabin in case of emergency” In case of emergency, if the cabin doors/windows cannot be opened, smash any window with the hammer to evacuate from the cabin Beware of sharp debris after breaking a window
	Warning! - risk of burns due to hot surfaces Risk of irreversible skin burns! Beware of hot surfaces (e.g.: radiator or hydraulic oil tank) right after operating the machine. Beware of hot oil or hot water spills as well.
	Warning! - Area with flammable/explosive substances smoking, fire or open flame are forbidden close to flammable parts of the machine (e.g.: the fuel tank), to prevent explosions.
	Warning! – risk of injury due to extrusion of machine’s top body You may be knocked off by the machine structure’s extruding parts keep a safe distance away from the machine’s rotation radius during its operation
	Warning! – attached interchangeable equipment may reach cabin area Some interchangeable equipment’s work range may reach up to the cabin and cause serious injury to the operator. Observe all preventive measures stated in the instruction for use to safely operate the machine.
	Warning! – risk of injury due to extrusion Indicates the danger of extrusion of booms or other machine parts You may be struck by moving parts of the machine

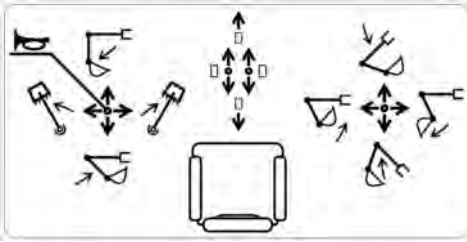
	<p>Do not stick your hand or head out of the cabin window during machine operation.</p>
	<p>Prohibition to use high-pressured water or steam to clean the machine Risk of electric shocks and irreversible damage through shortcut Do not use water or steam sprayers to clean the machine (even outer parts)</p>
	<p>Warning! – Risk of serious injuries due to ejection Adjusting the track tensioning device the wrong way may cause risks of injury due to the device being ejected out of the track Consult the instruction for use before adjusting the track with the device.</p>
	<p>Warning! - operation forbidden after shutdown If this sign is hung on the machine's main joystick, do not start the engine or touch the joystick until it is removed (by the previous driver or other personnels)</p>
	<p>Warning! – risk of burns Opening the engine vice water tank soon after operation may cause serious burns due to hot surfaces or hot water/steam. Cool down the coolant before opening the water tank.</p>
	<p>Warning! – risk of burns due to hot air/steam During or soon after the operation, touching the heating components of the engine, motor or muffler can cause serious burns. Let those parts cool down before touching them.</p>
	<p>Warning! Risk of limb crushing Risk of fingers/hands being cut off by the engine's fan. Do not start maintenance/repairs before the fan stops rotating after shutdown</p>
	<p>Warning! - Risk of limbs squashing by the pulley Do not approach your fingers to the pulley when it is moving Do not start maintenance/repairs until the devices stops running.</p>
	<p>Warning! - Risk of fall There is a risk of falling from the hood or baffle. Keep a safe distance to the edge.</p>

	<p>Caution! – Unstable area There is risk to trip and fall in this area Standing in this area is prohibited to prevent injuries</p>
	<p>Warning! – working area of a moving boom You may collide with the machine's device inside of its moving scope Keep a safe distance from the boom while it is operated.</p>
	<p>Notice for precautions before starting the machine Before starting the engine, you should observe the precaution measures indicated on this sign.</p>
	<p>Notice for storage prohibition Do not deposit/store/put anything in the area nearby this sign</p>
	<p>Caution! - safety procedure for unlocking a machine Always check your surroundings before opening the immobilizing lock lever of a machine: it may start moving in an unexpected manner.</p>
	<p>Danger! - Risks of explosion when handling an accumulator When using an accumulator, do not try to drill, cut, hit or decompose it. Keep it away from open flames.</p>
	<p>Notice – How to lever a machine's battery Explains the proper handling of a machine's accumulator battery</p> <p>Observe this notice to prevent injuries or damages to the battery</p>

2.9.2 Specific Designed Signs for Functions and Operation

	<p>Operation indication figure: Indicates activated functions depending on the position of the excavator's joystick control</p>
	<p>Operation of the dozer blade</p>
	<p>Travel sign Indicates the machine's travel direction</p>
	<p>Center of gravity Indicates the position of the machine's center of gravity.</p>
	<p>Bundling point sign Indicates the bundling point's position</p>
	<p>Lifting sign Indicates the the lifting point's position.</p>
	<p>Hydraulic oil sign: indicates a source of oil or the oil tank.</p>

Read and comprehend all safety information contained in this manual and the safety symbols related to the machine. Keep safety symbols in good condition; if any is missing or damaged, replace it immediately. If you have any question, contact an **XCMG agent** or **Xuzhou XCMG Excavator Machinery Co. Ltd.**

3 Safe Operation of Machine

3.1 Safety for Children



Children are normally attracted to machines and their operation. If children are in the vicinity of the machine and are not at a suitable distance and in the field of vision of the operator, this can lead to serious accidents or even death of the children.

Always observe the following rules of conduct:

Never assume that children will remain where you last saw them.

Keep children far away from the working area and always under the supervision of other responsible adults.

Be vigilant and switch the machine off when children enter the working area.

Never let children drive with you on machine, there is no safe place for passengers. Children could fall off the machine and be run over or affect the control of the machine.

Children must never operate the machine, even under the supervision of an adult.

Never let children play on the machine or attachments.

Be particularly careful when manoeuvring. Look behind and down below on the machine and ensure that there are no children in the manoeuvring area.

Before leaving the machine, park it so that it cannot move. When leaving the machine (e.g. for breaks or at the end of work), stop the engine, remove the key and close the cab door, if present.

3.2 Safety Rules

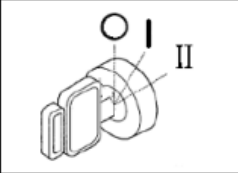
Notice	
	<ul style="list-style-type: none"> – When servicing the machine, do not use any worn-out/damaged tools to prevent injuries or unsatisfactory maintenance. – Check the fire extinguisher regularly and exchange/refill them if needed. – Ensure effective emergency training of all field personnel. – Know how to act in case of fire. – Note down all important emergency phone numbers (doctors, ambulances, hospitals and fire departments) beside every phone set. – Always keep safety devices in good working condition and never dismantle them on your own. – Missuse of safety devices may result in serious injury. – Always keep the machine's cabin clean. Be sure to remove the mud and oil remains on the shoes before entering the cabin to prevent serious accidents due to slipping – Do not use distractions like cell phones, radio or music on earphones when operating a machine. – Do not put any flammable and explosive materials in the cabin. – Ensure safety before boarding or leaving the machine's cabin – Before doing anything else other than operating the machine – (e.g. opening or closing windows/doors, dismantling or installing the lower front window or adjusting the seat) – Make sure to secure the machine as follows: <ul style="list-style-type: none"> ○ Lower the boom completely down to the ground. ○ Shut off the engine.
	<p>The key switch</p> <p>O (= OFF): when in this position, engine and electric supply will be cut/powerd off, but the cabin lamp and oil pump (if equipped) will still work.</p> <p>I (= ON): When in this position, all the machine's devices will be supplied with electric power.</p> <ul style="list-style-type: none"> – Turn the key switch to this position before starting the engine. – The charge indicator light and oil pressure indicator light will twinkle.

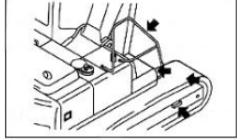
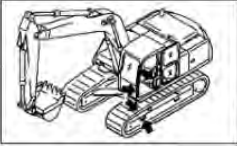

Handrails and steps

To avoid injury when climbing up and down the machine, use the handrails and steps marked by the triangular arrows in the drawing below.

To ensure safe boarding:

- Always face the machine while boarding or leaving it.
- Always keep hold on at least three points at any time while grabbing the handrails and/or stepping on the track shoes (either two feet and one hand or two hands and one foot).
- Never hold onto the joystick control.
- Never step on the engine without non-slip mat or cover plate.
- Check the handrails and steps (including the track shoes) for any oil contamination, lubrication grease or mud.
- Do not jump on and off the machine, especially while it is moving.
- If the machine moves suddenly without instruction for use operations, it is forbidden to jump up the machine and attempt to stop the machine.



Signals and gestures of the signalman

- Place the required warning signs when working on the roadside or other unstable ground.
- If there is poor sight, ask for a co-worker to act as a signalman.
- The operator shall pay close attention to the signs and follow the signalman's commands thoroughly.
- Only one signalman can send the signals. Before operating, make sure all of the workers understand all of the signals and gestures.

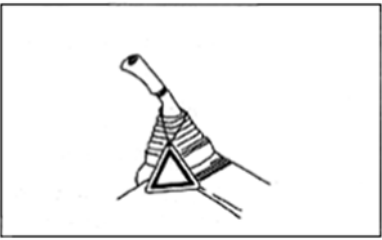

3.3 Pre-inspections and Safety

 Warning!	Never start the engine/touch any part of the machine: <ol style="list-style-type: none">1. during maintenance/service by other personnel or2. when a warning sign is hung on the joystick control In the last case, wait for the warning sign to be removed by the placer before operating the machine again.
	

3.3.1 Inspection prior to engine start

Notice	The following checkups must be carried out <u>before</u> starting the engine: <ul style="list-style-type: none">– Remove all obstacles in the area before starting the inspection.– Keep people away from the machine during the inspection.– Before entering the cabin, check around the vehicle for oil leaks, looseness, improperly adjusted safety devices damage on any components.– Wipe any dirt off:<ul style="list-style-type: none">○ the window surface to ensure good sight○ the headlight lenses and the operating light– Check if all lights are functioning properly, and also if they have the right angles– Check the the level of:<ol style="list-style-type: none">1. cooling liquid2. fuel oil3. engine oil– Check if the air filter is blocked and if the circuit is damaged.– Adjust the operator seat to a position suitable for your height and check if the safety belt/attaching clamp is damaged or worn out.– Check if the main control lever lies in the central position.– Adjust all mirrors to obtain the best possible vision of the rear.– In case of any abnormality, solve it right away to prevent accidental injury or machine failure later on.– Keep windows clean and make sure all doors/windows are fixed in a safe open/closed position.– Ensure that the horn, motion alarm (if installed) and other warning/safety devices are set up/working properly.– Check the undercarriage's orientation before moving the machine. <p>NOTE: In normal travel condition, the idler are located at the machine's front, below the cabin, while the sprocket should be at the rear.</p> <p><u>CAUTION!</u> : In case that the undercarriage is in the opposite position, the travel control lever must be operated in the opposite direction.</p>
---------------	---

	<ul style="list-style-type: none"> – Check the belt, buckle and tightening parts carefully. If there is any damage or wearout/tear, have the broken parts replaced before using the machine again. – Don't forget to buckle up firmly. – NOTE: abnormalities of the machine may not be found right away after engine starts, so that personal injury or machine breakdown may occur. – Maintenance and engine warm-up are required before start-up if: <ul style="list-style-type: none"> ○ the machine has not been used recently or ○ ambient temperature is very low (refer to chapter 3.2.2.1 for details)
--	---

3.3.2 Starting the Engine

Notice	NOTE: No one except the operator is allowed to sit in the machine.
	<ul style="list-style-type: none"> – Do not start the engine during maintenance/service or when a warning sign is hung around the driver's main control lever. – Warm up the engine and/or hydraulic oil before operation. – Do not start the engine in a way that may cause the ignition to short circuit. Because it will increase the risk of injuries and/or damage the machine. – Right after start-up, check the meters and monitor instruments for abnormal values or warning sounds. – Start and operate the machine only when seated with the seatbelt fastened – Make sure that all safety devices are in place to prevent accidents.

3.3.2.1 If temperature is close to or below freezing point

Notice	<ul style="list-style-type: none"> – Carry out the preheating operation conscientiously to prevent a lousy response of the joystick control or other machine parts. – Failure to do so increases the risk of causing an accident and/or damage to the machine – If the battery electrolyte is frozen, do not charge it or start the engine with external power. Both may cause the battery to catch fire. – Make sure that the battery's electrolyte is dissolved before charging it or starting the engine with external power.
---------------	--

3.3.2.2 – Precaution measures for operation in snowy weather

Warning!	<ul style="list-style-type: none">– Due to additional hazards on frozen and slippery ground, slowly and extra carefully– The iced ground surface becomes soft when the temperature rises up, and the machine will tip over.– If the machine enters into deep snow areas, it may tilt or become buried in the snow.
-----------------	--

3.3.3 Checks after starting the engine

Notice	<ul style="list-style-type: none">– Once again make sure that there is no person or obstacle in the surrounding area.– Check up if all the dashboard's instruments show a reasonable value– After starting the engine, sound the warning horn to alert people in the area before operation. <p>Always keep an eye on your surroundings for potential hazards during operation.</p> <ul style="list-style-type: none">–
---------------	--

3.4 Inspection before Operation

3.4.1 After starting the engine:

Notice	
	<ul style="list-style-type: none">– Check up if the engine or fuel oil is leaking.– Check for unusual sounds, vibrations, abnormal heat emissions or peculiar smells– Check if the instruments on the dashboard show unusual values after start-up– Check if all components respond without delay or difficulties, including<ol style="list-style-type: none">1) The mobility of the bucket and its rod2) The excavator boom's mobility3) The function of top body's rotation axis4) The machine's flawless moving and steering.5) Any oil or fuel leaks– Fix any abnormality at once to prevent serious injuries and/or damage to the machine during work <p>Chose the mode suitable for your task.</p> <p>NOTE: There is a blind spot in the machine's rear: a signalman may be needed to supervise your movements.</p> <ul style="list-style-type: none">– Pay close attention not to bump into other machines, persons or structures while driving.– Be aware of your surroundings at any time during work, even if all mirrors have been adjusted to maximise your visibility.

3.4.2 During machine operation

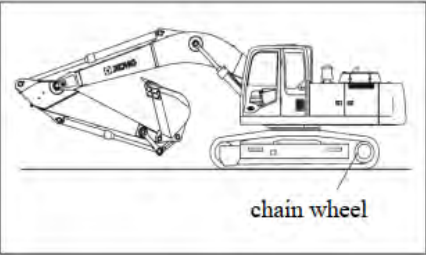
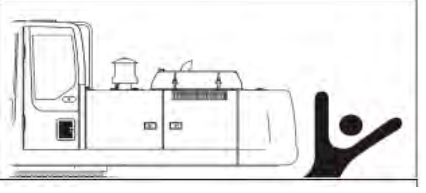
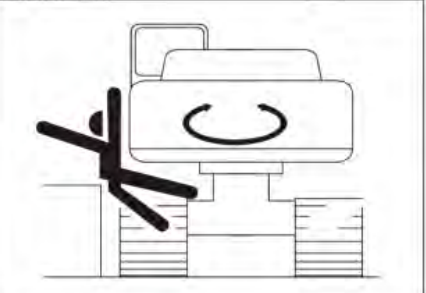
 Warning!	Safety Rules:
 <p style="text-align: center;">chain wheel</p>	<ul style="list-style-type: none"> ⚠ Before moving, orient the upper structure so that the carrier roller is located to the rear of the cabin. ⚠ If the carrier roller is in front of the cabin, the steering axis and directions will be reversed ⚠ (e.g.: going forward will result in moving backward and turning left will actually turn right. This only applies for the crawler tracks' controls, not the upper half of the machine).
	<ul style="list-style-type: none"> ⚠ Before moving, make sure again that there is no person or obstacle in the surrounding area. ⚠ Before moving, sound the horn to alert other people working in the nearby area. ⚠ Only operate the machine when seated with the safety belt fastened ⚠ No one is allowed to sit on the machine besides the driver.
	<ul style="list-style-type: none"> ⚠ Ensure that the door or the window of the cabin is locked. ⚠ Always operate the machine according to the above precaution measures. ⚠ When the machine turns or swings, there should be a signalman at the rear of the machine. ⚠ Take extra care not to touch other machines or people.

3.5 Machine Operation and Maintenance

3.5.1 Safety Rules for moving the Machine

Notice	<ul style="list-style-type: none"> • Take extra care when driving the machine over traffic bridges or through buildings under construction • Always confirm the above situation with your supervisor. <p>When the trailers drive on the road:</p> <ul style="list-style-type: none"> - Check the trailer's loading capacity - If required, obtain the authorisation to drive on the road <p>When crossing a river:</p> <ul style="list-style-type: none"> - The water level must stay below the upperstructure
---------------	---

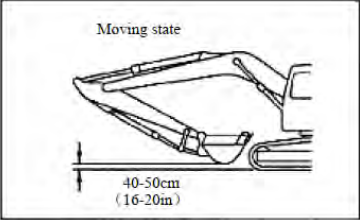
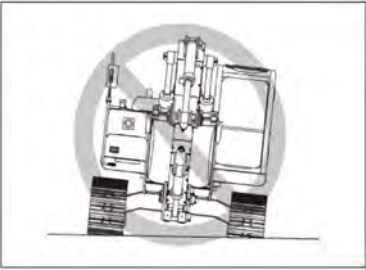
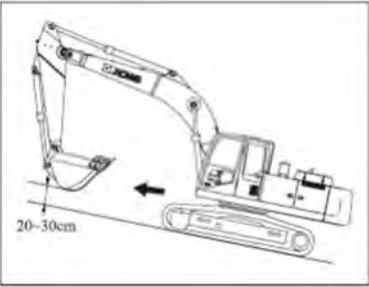
 Warning!	Safety Rules:
 <p>Moving state 40-50cm (16-20in)</p>	<p>Do not exceed the machine's maximum permitted load to prevent instability and avoid damaging the excavator's boom.</p> <p>If the interchangeable equipment touches the ground, the machine may lose balance and be damaged.</p> <p>When moving on flat ground, keep the interchangeable equipment at least 50 cm above the ground when retracting the boom before driving.</p> <p>When moving on the road, consult relevant department to inspect and then comply with their guidance.</p>
	<p>When passing over bridges or buildings, always verify if the structure is strong enough to support the machine's weight beforehand.</p> <p>When moving on rough ground, drive slowly and do not swerve to avoid risks of a rollover.</p> <p>When moving on the rough ground or the abrupt slope, turn off (cancel) the automatic speed reducing switch, If the machine is equipped with the automatic speed reducing device. If the automatic is turned on, the rotate speed of the engine is increased, and the moving will be suddenly accelerated.</p> <p>Avoid moving on the barrier as far as possible.</p> <p>If the machine has to move on the barrier, make the equipment close to the ground and move slowly.</p> <p>If the equipment touches the ground, the machine may lose balance and be damaged</p>
 <p>20-30cm</p>	<p>When approaching a steep slope, be sure to turn off the automatic engine break (if equipped) to prevent a sudden acceleration due to increased engine rotation.</p> <p>NOTE: If the automatic engine break is turned on, the movement will be suddenly accelerated due to increased engine speed.</p> <p>Avoid moving on obstacles as far as possible.</p> <p>If cumpulsed, always keep the equipment close to the ground and move slowly.</p>

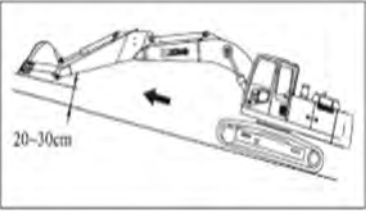
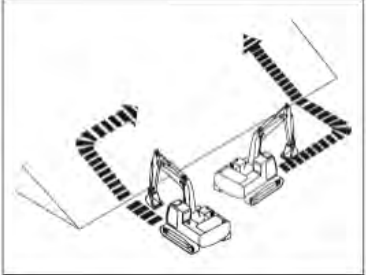
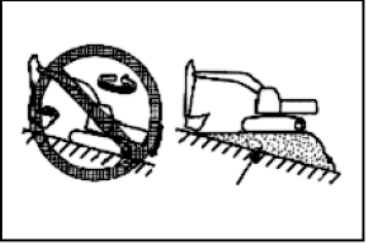
	<p>If the bucket/knapper touches the ground, the machine may lose balance and be damaged Observe the following requirements to avoid rollovers or sideslips of the machine:</p> <p>When moving upslope:</p> <ul style="list-style-type: none"> ⚠ Fold the boom and bucket close to a 90° angle as shown in the first picture ⚠ Make sure to keep the bucket/breaker at least 20 to 30cm (8 to 12 inches) above the ground. <p>NOTE: This way, the equipment can be quickly dropped down to stop the machine in case of an emergency.</p> <ul style="list-style-type: none"> ⚠ Be sure to turn the cabin towards the hill's top. ⚠ when climbing a very steep slope (close to 30°), stretch the machine's boom towards the front to maintain balance as shown in the picture ⚠ Keep the bucket/breaker at 20 to 30cm (8 to 12 inches) above the ground while driving at low speed.
	<p>When moving downhill:</p> <ul style="list-style-type: none"> ⚠ Keep the travel joystick control at the centered position to let the machine regulate the speed automatically with the engine break (if equipped). <p>NOTE: Do not make turns or transverses while on a slope as it may cause slipping or even tilt the machine</p> <ul style="list-style-type: none"> ⚠ Change the position of the machine on the flat area before climbing the slope. ⚠ Drive at low speed on slopes of low amplitude to avoid slipping. ⚠ If the engine stalls while moving on a slope, shift the joystick control to the middle position before restarting the engine ⚠ Examine the ground's hardness before moving the machine downhill a slope.
	<ul style="list-style-type: none"> ⚠ While on a slope, do not rotate the cabin or move the machine's boom to avoid tipping over caused by a loss of balance ⚠ Make sure to stand on a flat area when performing work tasks. ⚠ To avoid rollovers, do not rotate the cabin when carrying load on a slope. ⚠ While working on the slope, use platform to maintain the machine's balance.
	<p>If the engine stalls (including case of accidents where stop/start is impossible)</p>

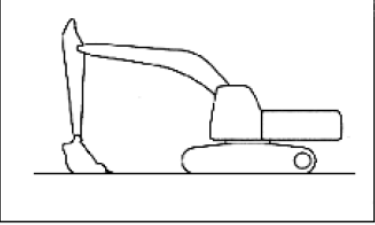
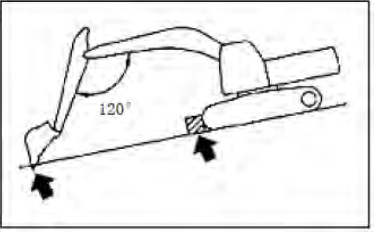
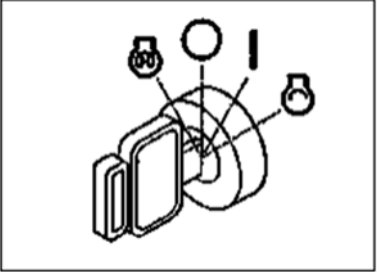
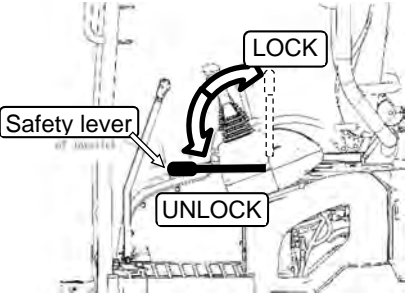
	<p>Parking the machine:</p> <ul style="list-style-type: none"> ⚠ Park the machine on firm and flat ground. ⚠ Park on a spot free of falling rocks or other hazards. ⚠ Lower the interchangeable equipment fully to the ground
	<p>Parking on a slope</p> <ul style="list-style-type: none"> ⚠ Adjust the upper structure toward the slope and stuff the interchangeable equipment into ground like on the picture. ⚠ Place pads in front of the track shoe to prevent the machine from slipping down the hill.
	<p>If the bucket/beaker is not firmly fixed to the ground, follow the steps below to release the pressure of the accumulator to secure the interchangeable equipment firmly into the ground:</p> <p>Make sure the key switch is set on "I" ("on") position and the meters and gauges are in active state</p> <p>Pull the safety locking lever to its free position to link the oil passage between the accumulator and control lever.</p>
	<p>Move the boom control lever slowly to carefully lay it down until the interchangeable equipment touches the ground.</p> <p>Slowly move the other control levers till the residual pressure of the accumulator is released.</p> <p>Turn the engine starter switch to "O" ("OFF") position and pull the safety lever to the locking position. Adjust the safety lever (1) to the locking positions, and shut off the engine before leaving the machine</p> <p>Prevent unauthorized people from accessing the machine by locking the cabin door and taking the key with you or leave it at the field office</p>

3.5.2 Towing broken machines

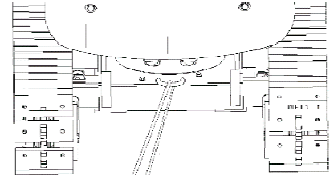
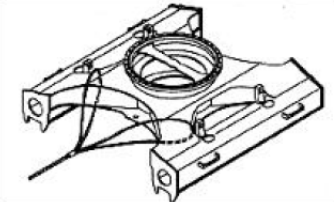
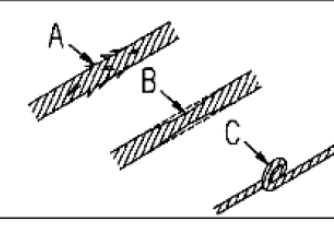
⚠ Warning!	Safety rules and advice
  	<p>Serious injury or death may occur if:</p> <ul style="list-style-type: none"> – If the faulty machine is not towed according to the instruction for use or – The wire ropes used are too thin/weak or not fixed in the prescribed manner <p>Wear leather gloves when handling wire ropes.</p> <p>Fix the wire ropes on the machine frame (see sketch)</p> <p>WARNING! In the traction process, do not stand between traction machine and towed machine</p> <ul style="list-style-type: none"> – Never pull the machines on slopes – Wire ropes which are either broken (A), have a reduced diameter (B) or are bent or tangled (C) must not be used. <p>WARNING! In the traction process, the wire ropes may break easily, in which case dangerous accidents may occur.</p>

3.5.3 Safety Rules for Lifting Load and Objects

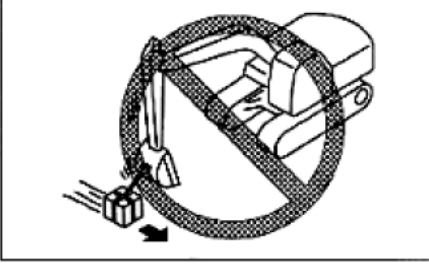
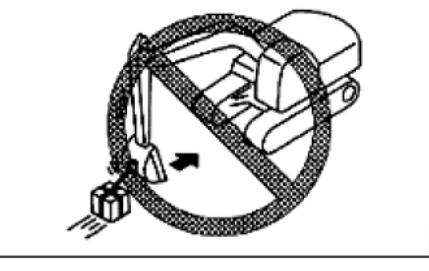



⚠ Warning!	
 	<ul style="list-style-type: none"> ⚠ This machine is not suitable for lifting jobs if not equipped with the proper interchangeable equipment ⚠ The appropriate interchangeable equipment is selected according to the compatibility to the available machine models. ⚠ When working, switch the machine into “lifting mode”. ⚠ Make sure the machine engine has sufficient torque to carry out lifting jobs when it is set on “load lifting”- mode. ⚠ When lifting, choose excavating mode as working mode to ensure that the hydraulic machine has sufficient power to carry out lifting job. ⚠ In case that the machine needs to lift objects with unusual shape (e.g. round logs), make sure to use the appropriate safety devices that may not be mentioned in the instruction for use. ⚠ Contact an authorized local agent if you need information about methods for safe operation, carrying out special jobs or specifications about working in all kinds of environment.

 Warning!	Safety rules for object lifting
	<p>When lifting objects:</p> <ul style="list-style-type: none">⚠ Do not lift objects on slopes, soft ground or other places where the machine may become unstable.⚠ Make sure the used wire ropes meet the required standards.⚠ Keep focused at any time during lifting jobs. Stop the process instantly if you feel the machine is about to tip over.⚠ To avoid collisions, watch out your surroundings carefully before rotating or turning the machine while lifting objects.⚠ To avoid object oscillation, never make sudden movements with the machine.⚠ Do not lift objects from the side or towards the machine.⚠ Never leave the seat/machine while objects are lifted. Always put them back on the ground first.⚠ Lifting objects is not part of intended use for this machine. Do it on your own responsibility

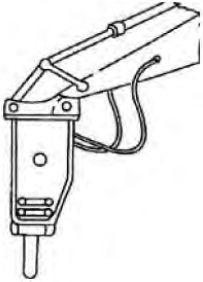
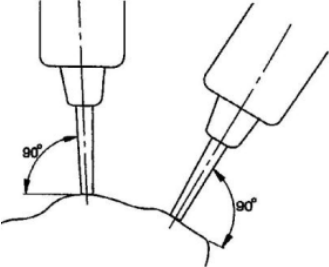
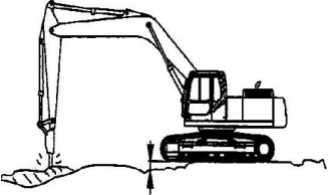
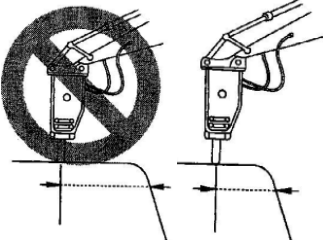
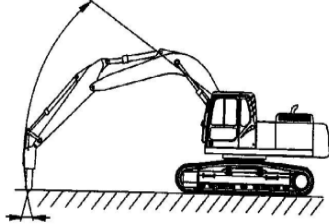
3.6 Interchangeable Equipment (Optional Components)

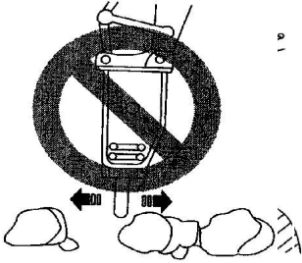
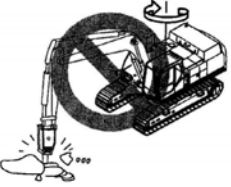

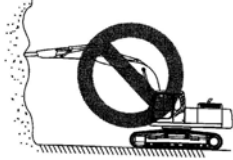











Notice	
	<p>NOTE: The standard package for excavators does not include safety devices or a knapper.</p> <ul style="list-style-type: none">– Contact an authorized special parts dealer or XCMG to have them install the knapper during the first time.– Listen carefully to the installation instructions to manage the task by yourself in the future– If any part of the safety devices become torn or broken, have them replaced by an authorized special dealer or XCMG.– Only use any interchangeable equipment (e.g. the bucket or knapper) according to their range of application.– Make sure to install the bucket/knapper properly by observing the instruction for use.– Ask for support when attaching interchangeable equipment.– Never remove safety devices without approval <p>NOTE: →Without proper working safety devices, the machine will lose its conformity according to machine directive (2006/42/EG) and other applicable directives or regulations.</p> <ul style="list-style-type: none">– When attaching interchangeable equipment for the first time, be sure to carefully estimate the appropriate safety distance to the operator in the cabin.– Adjust the knapper's inclination angle accordingly– Keep the knapper from intruding the cabin to avoid serious injury.– Do not let anyone ride on the bucket or hydraulic breaker as it may result in serious injuries or death <p>NOTE: If the operator is changed, the new one must pay special attention to the training on how to attach interchangeable equipment and recognise it as conforming to the guidelines and standards.</p>

Notice	Advice for using the knapper
	<p>Main Functions of the Knapper</p> <p>The Knapper is generally used for:</p> <ol style="list-style-type: none"> 1. demolishing buildings 2. crushing road surfaces 3. excavating/building tunnels 4. crushing cinders and 5. crushing/cutting rocks
	<ul style="list-style-type: none"> - Press the drill rods tightly onto the surface at a right angle, as shown in the sketch. <p>NOTE: When striking, the drill rods will be pressed tightly on the surface, and the machine frame may be lifted up to 5 cm above ground.</p>
	<ul style="list-style-type: none"> - Never let the inclination become higher than this as it may cause the machine to tilt.
	<ul style="list-style-type: none"> - If the surface is repeatedly struck, but not broken in 1 minute, the hammer should be moved and break the surface from the edge.
	<ul style="list-style-type: none"> - The striking direction of the drill rod is slight deviated from the direction of the hammer. - Therefore, the direction of oil cylinder of the bucket must be rectified to ensure the direction alignment

Notice	Special cases for Knapper Operation
	<ul style="list-style-type: none"> - During operation, the rip end should not be reached. - Keep a distance of about 5 cm instead. - Press the drill rod with additional force to avoid void striking if needed - Do not swing the rod while it pierces the rock.
	<ul style="list-style-type: none"> - Do not rotate the cabin while crushing rocks.
	<ul style="list-style-type: none"> - When striking, do not move the drill rod around.
	<ul style="list-style-type: none"> - Do not strike horizontally or upward.
	<ul style="list-style-type: none"> - When making contact with the ground, make sure to keep the drill rod vertical to it.
	<ul style="list-style-type: none"> - When lifting the machine, do not extend the bucket cylinder to the maximum.

3.7 Safety Rules for Handling the Battery

3.7.1 Hazards involved with the battery:

 Danger!	
	<p>Caution! The battery's electrolytes contain sulfuric acid, which is corrosive!</p> <p><u>DANGER!</u> When charging the battery, beware of the highly flammable and explosive hydrogen gas generated in the process!</p> <p>Non-conformed handling of the battery may cause serious damage to it, the environment, or cause fire hazards. Observe the following measures to prevent those:</p> <ul style="list-style-type: none"> If the densimeter's display is black, charge the battery immediately. A bright display means, the battery must be replaced. Be sure to wear goggles and rubber gloves when handling the battery. Never smoke or use open fire at any time when close to the battery. Wash out clothes or skin thoroughly with water if sulfuric acid splashes on any. In case that sulfuric acid is spilled in the eyes, wash them out with abundantly water and contact the closest hospital for immediate treatment. Beware of sparks the battery may generate during operation/handling and make sure to turn the key switch to the 'close' (off?) position before maintenance/operation? Carry out the maintenance by following the steps below: When <u>disassembling</u> the battery, <u>start</u> by disconnecting the <u>negative terminals</u> (grounding side). When <u>installing</u> the battery, connect the <u>positive terminals</u>, <u>first</u>, then the <u>negative terminals</u> (grounding side). Do not make tools or other metal objects contact the battery terminals or drop them on/close to the battery Before charging, disassemble the battery from the machine and carry in a <u>well-ventilated</u> environment. Finally, firmly reinstall the battery in its original position after maintenance

3.7.2 Battery Switch

Notice	The battery switch
---------------	---------------------------



switch the battery OFF when:

- Not operating the machine for more than one month.
 - Maintaining the electrical system.
 - Disposing of the battery.
 - Replacing the fuse and/or fuse link.
 - Connecting the auxiliary cables.
- NOTE: Disconnect the operation of the accumulator jar switch one minute later after the engine is turned off.

Caution! To avoid damaging the electrical system, do not turn off the battery while the engine is still running.

NOTE:

- After disconnecting the accumulator jar switch, the whole electrical system will be cut off.
 - This may delete the radio's stored data set. Reset the data in case that this happens.
- Cut off the power supply from the storage battery to the machine's electrical system.

NOTE: this switch is located under the pedal base, which is nearby the main valve .

(O) (= "OFF"-position): Cuts off the electric current. Keep the switch at a free sagging state while in this position.

(I) (= "ON"-position): Electric current is flowing through the circuit. Make sure the switch is turned on before starting the engine.

3.7.3 Starting the engine using auxiliary cables



Warning!

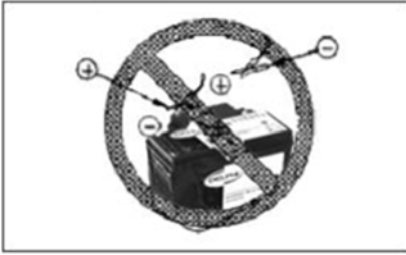

The battery may explode if the auxiliary cables are connected the wrong way. Make sure to observe the following rules:

- Two persons are necessary when starting the engine using auxiliary cables: one operates the machine from the cabin, seat, and the other levers the battery.
-
- When using another machine's battery to start your own, do not connect the two machines together.
- Before connecting the auxiliary cables, turn the start switches of both the working and the faulty machine off. Or any of them may move when power is supplied.
- When installing the auxiliary cables, first connect the positive (+) pole.
- When removing the auxiliary cables, start by disconnecting negative (-) pole (grounding side).
- When the auxiliary cables are removed, make sure the clamps do not contact.
-
- The same goes for cable clamps and machines.
-
- Always wear goggles and rubber gloves when handling the batteries and cables
- Connect two machines with the same battery voltage with the faulty machine should be used.

3.8 Forbidden Operation

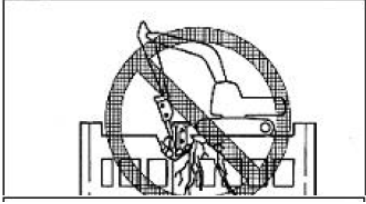
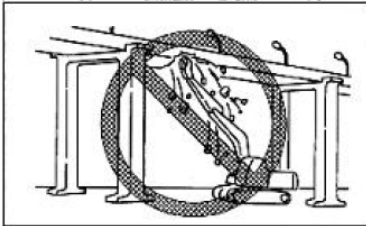
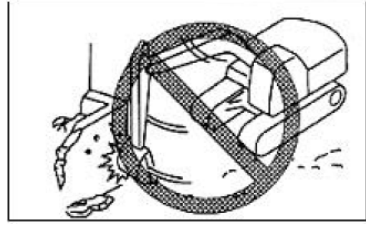
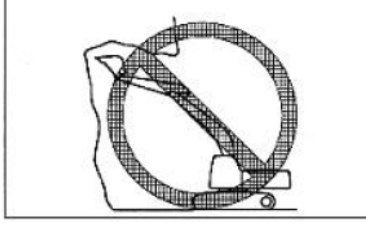
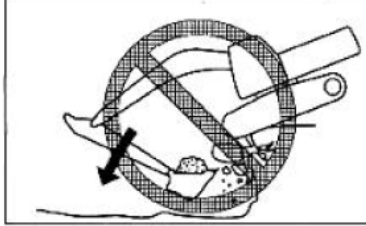
 Danger!	Safety Warnings:
	<ul style="list-style-type: none"> ⚠ Dismantling or demolition tasks must not be carried out below the machine. ⚠ WARNING! A dismantling process will unbalance the machine, increasing the risk of tip-over. ⚠ You must not operate the machine on buildings or foundations, as they may crumble down due to its massive weight ⚠ Do not dismantle/demolish the area right above the machine.
	<p>→ The falling debris may cause serious injuries and/or damage the machine</p> <p>NOTE: The excavator's boom is usually easier to incline from the side than from the front or rear position.</p> <p>WARNING! Using crushers or other heavy interchangeable equipment may increase the risk of tipping over the machine.</p>
	<p>Operating the machine on flat area or slopes:</p> <ul style="list-style-type: none"> ⚠ Avoid sudden movements with the machine's boom. ⚠ Avoid sudden movements with boom's cylinder, including stretch out or withdrawing. <ul style="list-style-type: none"> →the impact will damage it. ⚠ Do not put the bucket above the heads of other workers or seats of operators of other transporting equipment.(see snow ground part) ⚠ Because the loads may fall out, the bucket can contact the dump trucks so as to cause serious ruin or damage. <p>The gradeability labeled in the technical specifications doesn't mean the allowable slope operating range of the machine.</p> <p>NOTE: Ideally use this machine on slopes with an angle below 15°. Otherwise the machine will face risks of slipping and/or tilting.</p>
	<ul style="list-style-type: none"> ⚠ Do not dig out the working surface below a suspended area. <ul style="list-style-type: none"> → Otherwise the store may collapse of the suspended part and fall onto the machine, causing serious injuries and/or damage to the machine.
	<ul style="list-style-type: none"> ⚠ Do not deeply dig the ground in front of the machine. <ul style="list-style-type: none"> → Otherwise, the ground beneath the machine will collapse, causing it to fall.

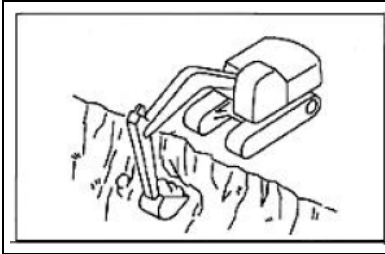

⚠ Before excavating, adjust the dozer blade so as to form a right angle with the waysides or cliffs in front of the sprockets to ensure an easy getaway in case of a ground collapse (see the sketch)

3.8.1 Location of Safety Signs on Machine

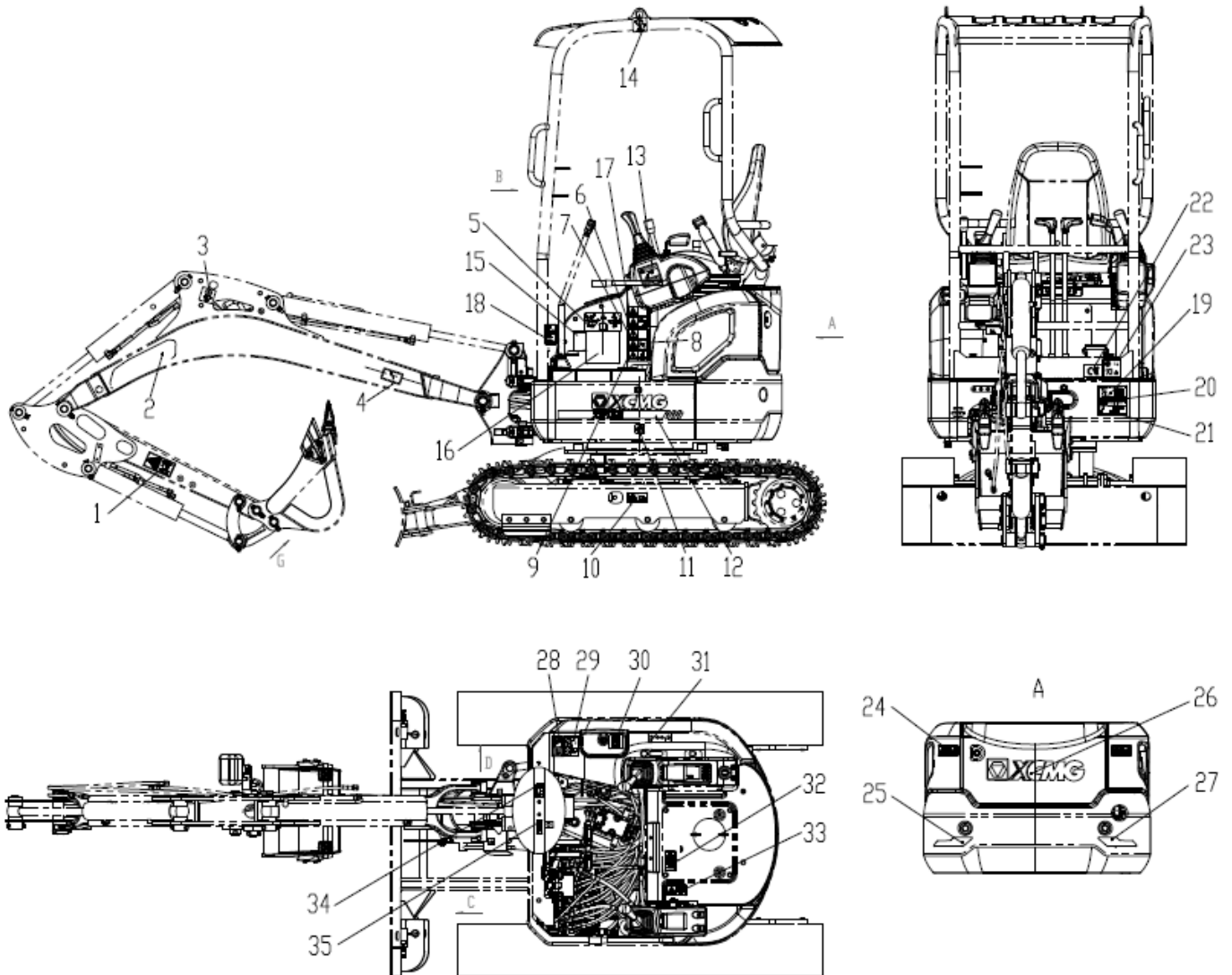

<ul style="list-style-type: none"> 1 Arm safety sign 2 Corporate logo 3 Lift sign 4 Squeezing safety sign 5 Operation sign 6 Safety sign for leaving the operator's seat 7 "Read the operating and maintenance manual" sign 8 "Prevent electric shock" safety sign 9 Safety belt sign 10 Crawler adjustment sign 	<ul style="list-style-type: none"> 21 Authorization sign 22 CE sign 23 Noise sign 24 Counterweight squeeze safety sign 25 Reflector sign 26 Corporate logo 27 Reflector sign 28 Explosion protection safety sign 29 Diesel oil sign 30 Hydraulic oil sign
<ul style="list-style-type: none"> 11 Center of gravity 12 Corporate logo sign 13 Lock lever safety sign 14 Lift forbidden sign 15 "Lift complete machine" sign 16 "Capacity of crane" sign 17 "Crushing appliance" safety sign 18 High or low speed switch sign 19 Product nameplate 20 Rivet 3.2x9-11 	<ul style="list-style-type: none"> 31 Dozer blade 32 High-temperature burn safety sign 33 "High-pressure injection" 34 Deflection indication sign 35 Lock sign

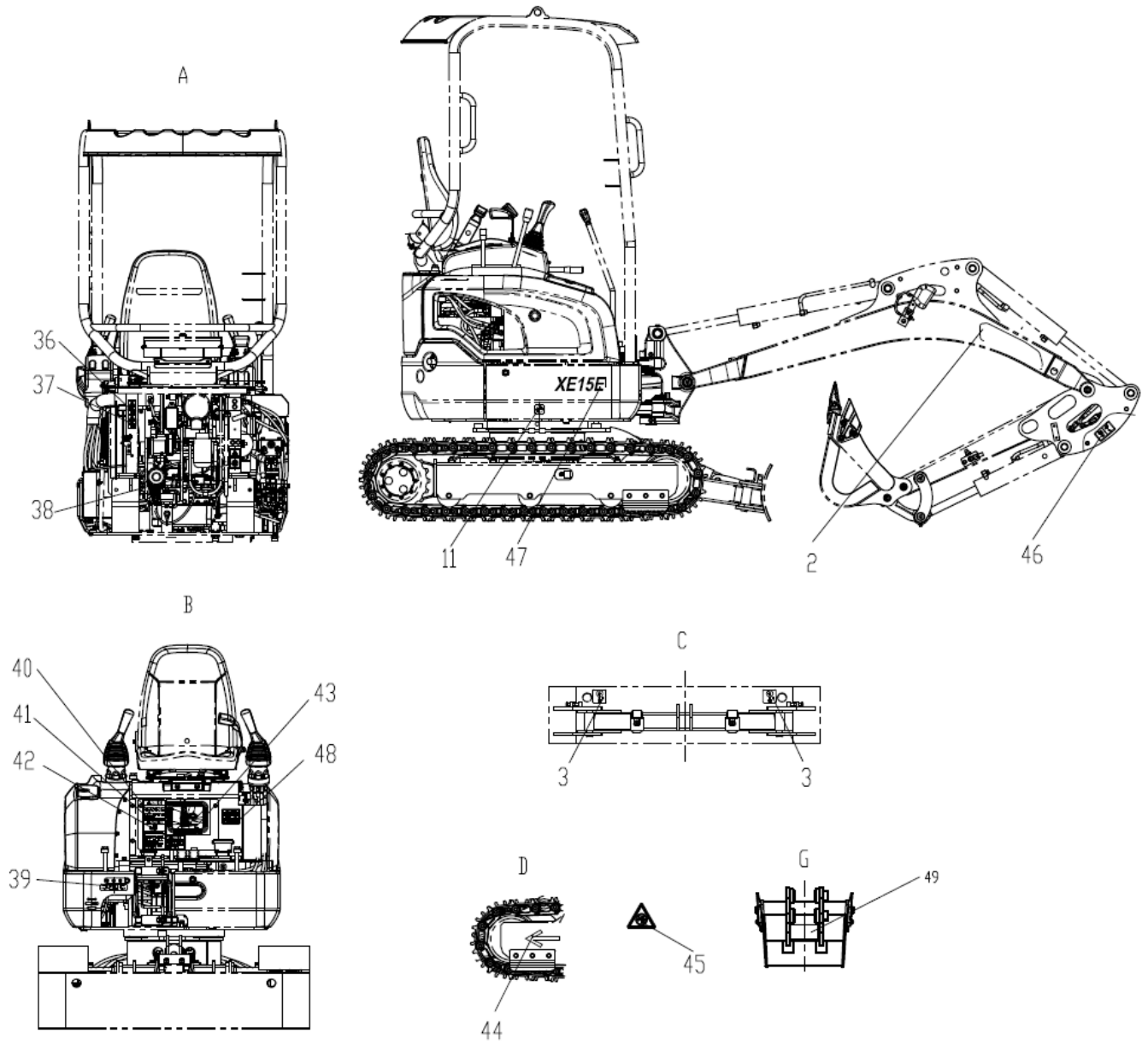

36 Guard safety sign	43 Lubrication and maintenance sign
37 Belt drive safety sign	44 Whole machine travel sign
38 "Prevent scald" safety sign	45 Forbidden sign
39 Knapper safety sign	46 Single and double direction circuit switch sign
40 Engine start safety sign	47 Model sign
41 Transport safety sign	48 TOP & FOP sign
42 Lift and transport sign	49 "Type of bucket" nameplate

4 Machine Overview

4.1 Machine Arrangement



(1) Arm

(2) Bucket cylinder

(3) Bucket link 2 and 3

(4) Bucket link 1

(5) Bucket

(6) Swing bracket

(7) Crawler tracks

(8) Dozer blade

(9) Arm cylinder

(10) Boom

(11) Working headlight

(12) Canopy(Rops / Fops)

(13) Boom cylinder

(14) Sprocket

(15) Idler

(16) Dozer cylinder

4.2 Machine Data

4.2.1 Overall Data

Machine model	XE17U	Unit
Operation weight	1795	kg
Standard bucket capacity	0.04	m ³
Length/width/height	3560/1240/2350	mm

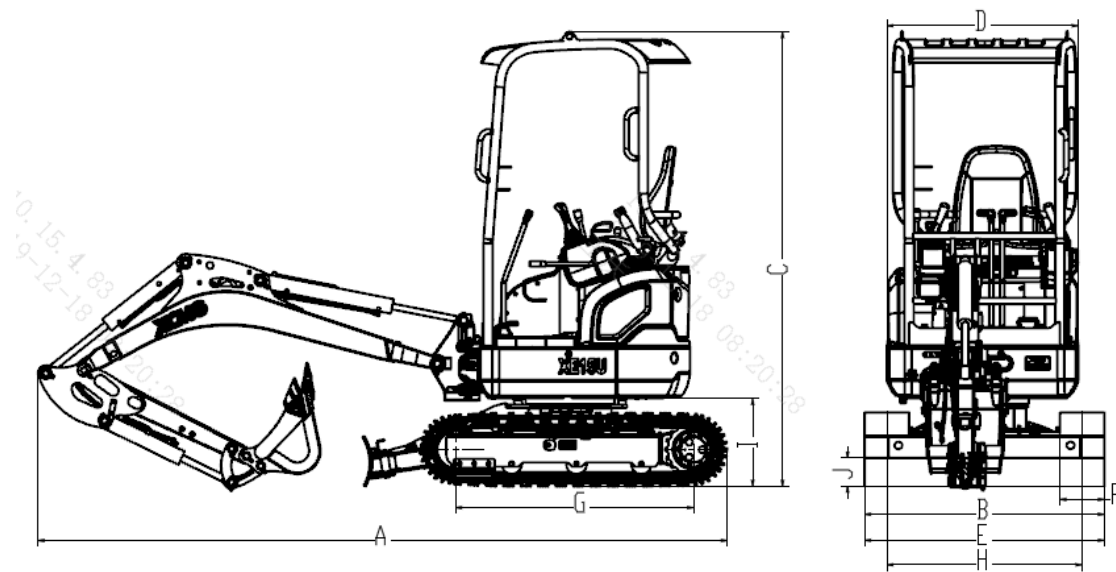

Overall dimension	A Total length	3560	mm
	B Total width	1240	mm
	C Total length of cab	2350	mm
	D Width of platform	990	mm
	E Overall width of chassis	990/1240	mm
	F Length of crawler	230	mm
	G Wheel base of crawler	1270	mm
	H Track gauge	760/1010	mm
	I Ground clearance of counterweight	450	mm
	J Min.ground clearance	145	mm
	Dozer blade (width/height)	1240x258	mm

4.2.2 Working Range

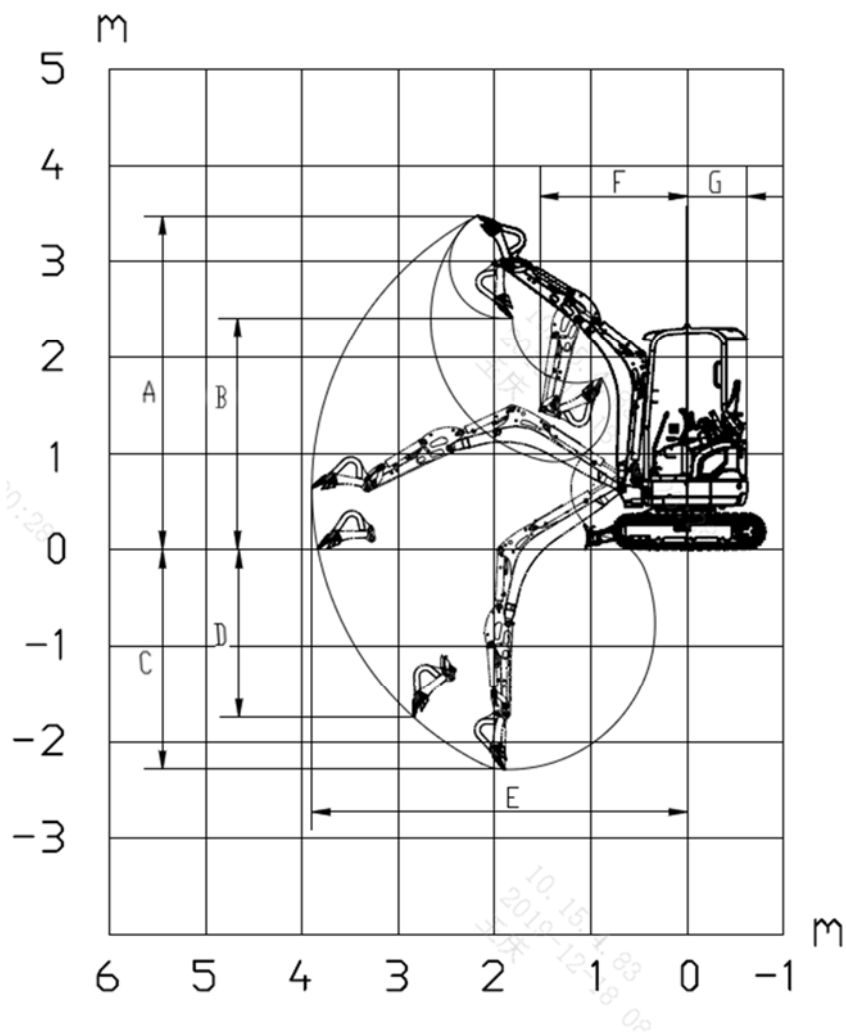

Working range	A :Max. digging height	3475	mm
	B :Max. dumping height	2415	mm
	C :Max. digging depth	2290	mm
	D :Max. vertical wall digging depth	1750	mm
	E :Max. digging reach	3900	mm
	F :Min. swing radius	1550	mm
	G :Min. tail swing radius	620	mm

4.3 Operating Conditions

- Ambient temperature: -15°C--40°C
- Altitude: 0m-2000m
- Slope of the ground: less than 15°.
- Wind speed: lower than 5m/s.
- Working place: Non-swamp
- Job object: 3 or less grade soil level and loose materials
- Requirements for ground: the ground must be solid and flat.

When using the machine beyond the above conditions, please contact our distributors/dealers or our service department to obtain an approval.

4.4 Emissions

4.4.1 Noise Data

- Guaranteed sound pressure level LPA in the cabin 80 dB(A)
(according to the dynamic test procedures and conditions that are specified in ISO 6396:2008)
- Guaranteed sound power level LWA of the machine 93 dB(A)
(according to the dynamic test procedures and conditions that are specified in ISO 6395:2008)
- The noise measurement data was determined in accordance with the standard ISO 6395:2008
- The sound level may vary at different engine cooling fan speeds.
- Reflections may increase the sound pressure level by 5 dB(A) to 10 dB(A) when working in confined spaces
- The declared sound levels listed above include both measurement uncertainty and uncertainty due to production variation.

4.4.2 Vibration Data

The European Union physical agents (vibration) directive 2002/44/EC: information concerning hand-arm vibration level and whole-body vibration

Vibration data for excavator	Trigger value
Effective acceleration value for the upper extremities of the body (hand-arm vibration)	<2.5 m/s ²
Effective acceleration value for the body (whole-body vibration)	< 0.5 m/s ²
Note: All vibration levels are in m/s ² (meter per second squared).	

Vibration levels are influenced by many different parameters originating from:

- Operator: training, behaviour, working method and stress
- Jobsite: organization, preparation, environment, weather conditions and material.
- Machine: type, quality of seat and suspension system, attachment, equipment, condition.
- It is not possible to get the precise vibration levels of the machine.

**ISO/TR 25398:2006 Annex B (reference information):
Equivalent vibration values of whole-body vibration emission of earth-moving machinery**

Machine type	Typical operation condition	Vibration levels			Standard deviation/ scenario factors		
		X axis	Y axis	Z axis	X axis	Y axis	Z axis
Compact crawler excavator (service weight ≤6000Kg)	Excavating	0.33	0.21	0.19	0.19	0.12	0.10
	Knapper application	0.49	0.28	0.36	0.20	0.13	0.17
	Transfer movement	0.45	0.39	0.62	0.17	0.18	0.28

Note: All vibration levels are in m/s^2 (meter per second squared). The expected vibration levels can be estimated with the information in the Table to calculate the daily vibration exposure.

Notice!

- A simple evaluation of the excavator application can be used.
- For further vibration indications, refer to the indications in ISO/TR 25398 Mechanical Vibrations – Directive on Estimation of whole-body vibration during operation of earth-moving machines.
- This publication uses measuring values of international institutes, organizations and manufacturers.
- It contains information on whole-body vibration for operators in earth-moving machines.
- For more information on the vibration values of the machine, refer to Directive 2002/44/EC of European Parliament and Council on minimum health and safety requirements regarding exposure of workers to risks arising from physical agents (vibration).
- Your **Xuzhou Construction Machinery Group Co., Ltd.** dealer provides information on other machine functions reducing vibration and on safe operation

Notice!

Directives on reducing vibration levels on earth-moving equipment

- Properly adjust machines.
- Operate machines smoothly.
- Perform correct adjustments and maintenance on the machine.
- Keep slopes in a perfect condition

Notice!

The following guidelines for reducing the whole body vibration levels on earth-moving equipment:

- Use a machine and equipment of correct type and size.
- Follow the manufacturer's recommendations for maintenance:
 - a) Tyre pressure.
 - b) Brake and steering systems.
 - c) Control, hydraulic system and linkage.
- Keep the job site in a good condition:
 - a) Remove large rocks or obstacles.
 - b) Fill up ditches and holes.
 - c) Provide a machine and enough time to keep the job site in a good condition.

- Use an operator seat according to the ISO 7096 requirements. Keep the operator seat in a good condition and adjust it correctly:
 - a) Adjust the operator seat and suspension to the operator's weight and size.
 - b) Check and maintain the seat adjustment and suspension.
- Perform the following activities smoothly without any jerks:
 - a) Steering
 - b) Braking
 - c) Acceleration
 - d) Shifting gears
- Move attachments without any jerks.
- Adapt your speed and the itinerary to minimize vibration:
 - a) Travel around obstacles and uneven ground.
 - b) Reduce your speed during machine travel across rough terrain.
- Reduce vibration to a minimum during long work cycles or during machine operation over long distances:
 - a) Use a machine with a suspension system (for example on the operator seat).
 - b) Enable the hydraulic oscillation damping if the machine is equipped with tracks.
 - c) If the machine is not equipped with hydraulic oscillation damping, reduce your speed to avoid bumps and jolts.
 - d) Load the machine on a truck or a trailer to move between job sites.
- Other risk factors can affect drive comfort negatively. The following measures can improve drive comfort:
 - a) Adjust the operator seat and the control elements to a relaxed body posture.
 - b) Adjust the rearview mirrors to ensure optimal visibility so you can adopt an upright seating position.
 - c) Provide breaks to avoid sitting for long periods.
 - d) Avoid jumping off the cabin.
 - e) Minimize repeated handling and lifting of loads.
 - f) Minimize any shocks and jolts during sports and leisure activities.
-

4.5 Technical and Performance Data

Notice!

This machine is a backhoe hydraulic crawler excavator with full swing and single bucket. It is widely used in urban and rural construction like municipal construction, irrigation and water conservancy as well as earth-working construction.

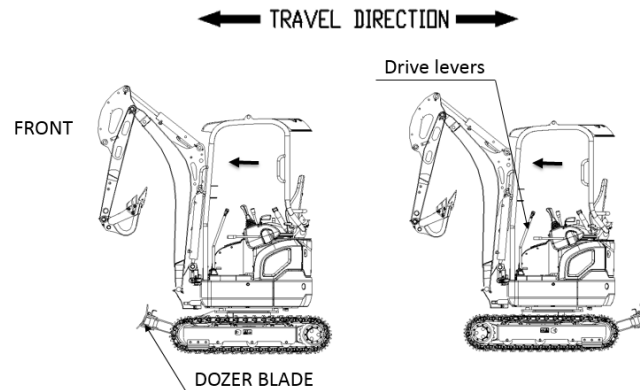

4.5.1 Engine

Engine	Model	D902	--
	Rated power	11.8/2300	kW/rpm
	Maximum torque	51.3/1800	N.m/rpm
	Output volume	0.778	L
	Fuel tank	17	L

4.5.2 Hydraulic System Data

Hydraulic system	Main pump	Variable displacement piston pump	--
	Rated flow (main pump flow)	64.4	L/min
	Working pressure	24	MPa
	Hydraulic oil tank	18	L

4.5.3 Performance Parameter

Performance parameter	Rotating speed	9	r/min
	Bucket digging force	16	kN
	Arm digging force	10	kN
	Maximum traction force	15.6	kN
	Traveling speed	3.1/2.1	km/h
	Gradeability	58	%
	Ground pressure	28.5	kPa

4.6 Hydraulic Schematic Diagram

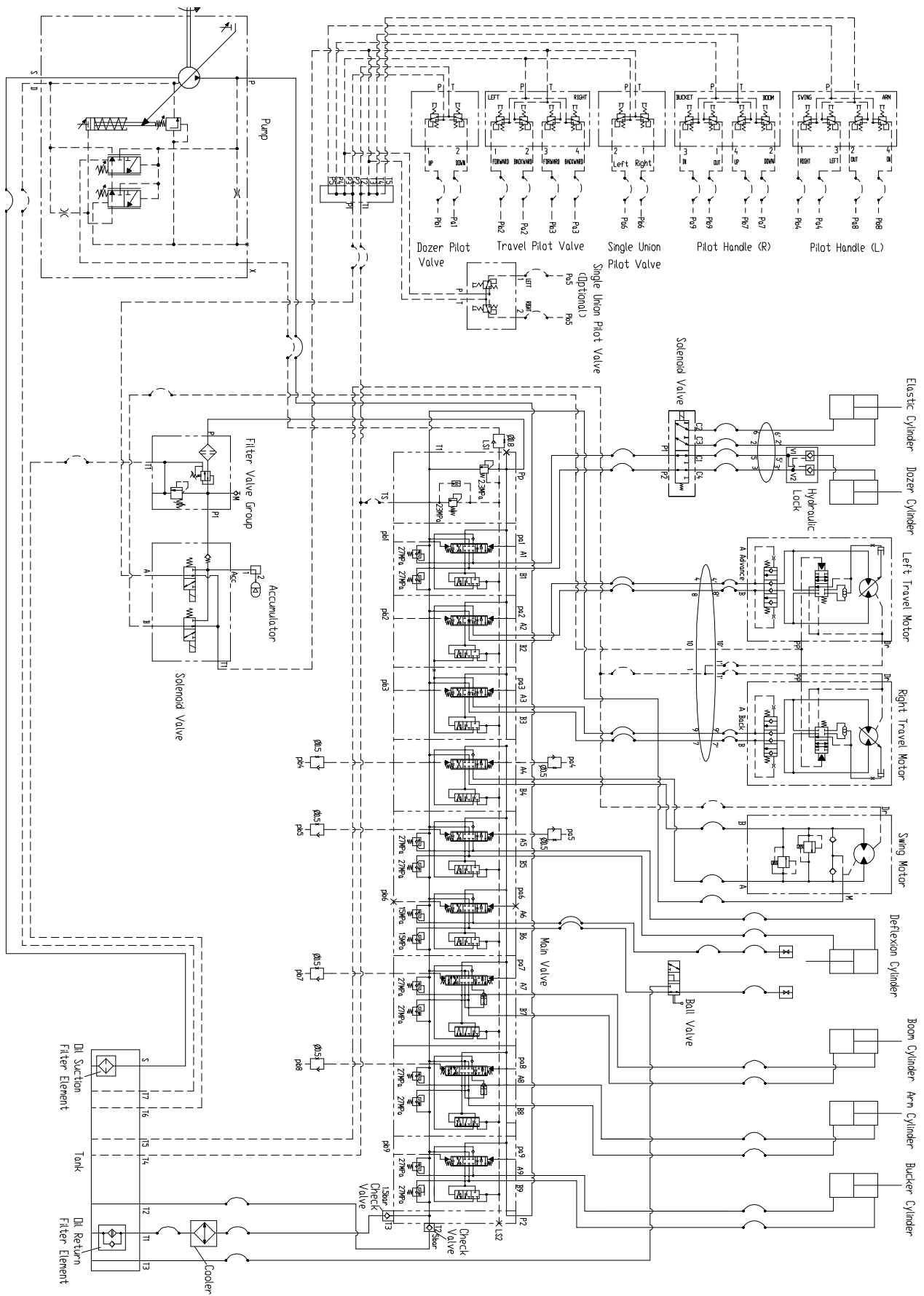

- **Record all part numbers correctly for future maintenance or reference**
- Make sure to send a copy of this information to your distributors.
- If this copy of instruction for use is stored inside the machine, make sure to keep its part numbers in a separate place. This will ease the search in case of a loss.
- All numbers gathered on this page are the **unique identification numbers, (serial/part numbers)** of each machine and **every hydraulic part!**
- Fill these identification numbers in the corresponding places for a quick reference if required.

4.8.1 Nameplate – Serial Number

Model: _____

Rated power: _____

Operating weight: _____

Product identification No.: _____

Production date: _____

HYDRAULIC EXCAVATOR	
MODEL	_____
RATED POWER	_____
OPERATING MASS	_____
PIN ON	_____
DATE OF MANUFACTURE	_____
XUZHOU XUGONG EXCAVATOR MACHINERY CO.,LTD. CE <small>ADD: No.39 Gaixin Road, Economic Development Zone, Xuzhou City, 221000, P.R. China</small>	

Fig. 2 Nameplate and Serial Number

4.8.2 Engine

Engine

Model: _____

Manufacturing No.: _____



4.8.3 Hydraulic Travel Motor

Travel motor

Model: _____

No. : _____



4.8.4 Hydraulic Swing Motor

Travel motor

Model: _____

No. : _____

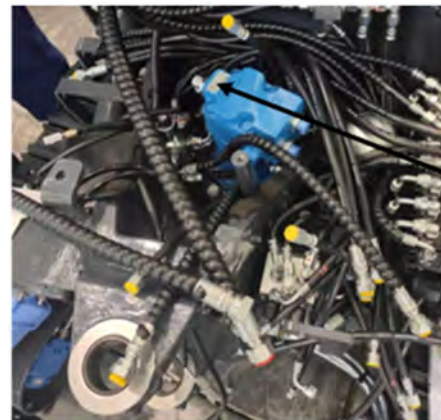

4.8.5 Hydraulic Pump

Hydraulic pump

Model: _____

No. : _____



4.8.6 Frame

Frame

No. : _____



4.8.7 Boom

Boom base

No. : _____



4.8.8 Arm

Boom top

No. : _____



4.8.9 Bucket

Bucket

No. : _____

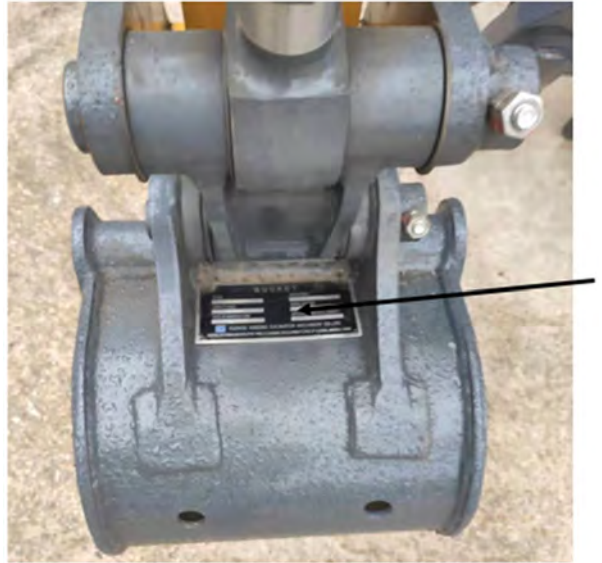

4.9 Driver's Cab

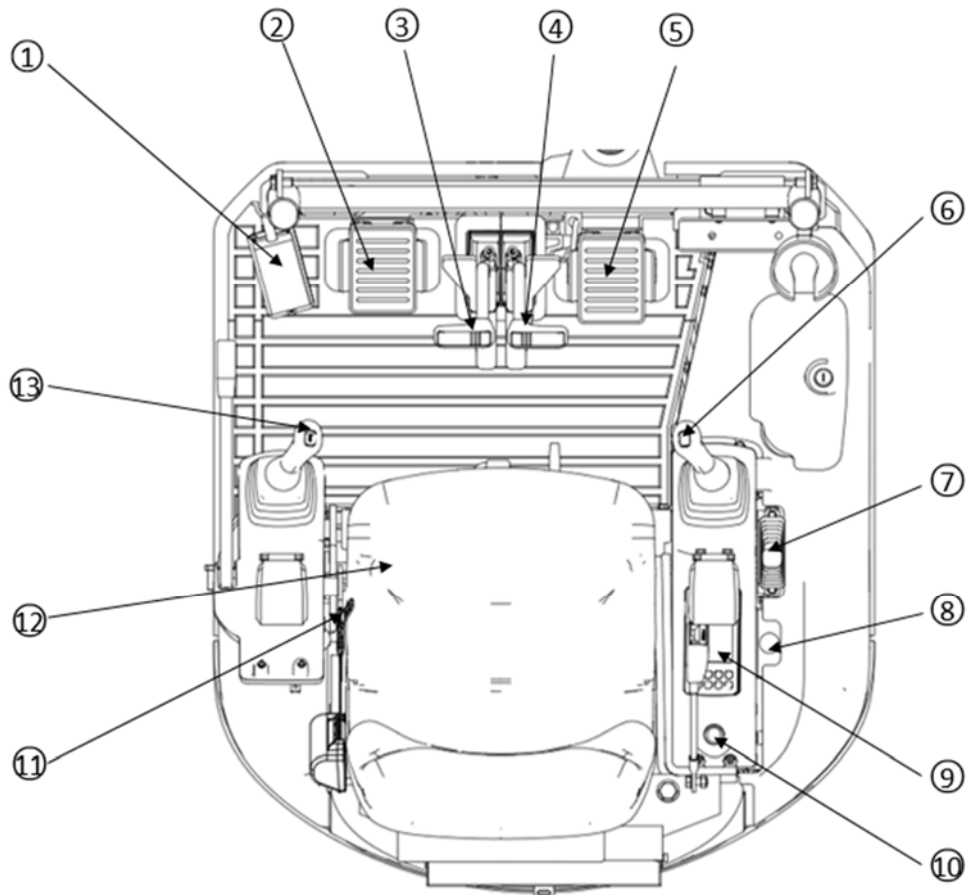

1. Travel speed control pedal
2. Auxiliary pressure port pedal
3. Left traveling control lever
4. Right traveling control lever
5. Boom deflection pedal
6. Right joystick
7. Dozer control lever

8. Engine speed control lever
9. Display and button unit
10. Engine starter switch
11. Safety lever
12. Operator's seat
13. Left joystick

4.9.1 Left travel control lever and pedal, right travel control lever and pedal

- The left and right travel control levers/pedals are used to control the traveling movements.
- Each lever/pedal controls the respective track (see sketch on the right).

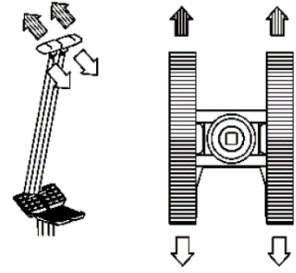

4.9.2 Right joystick

This joystick is for controlling the boom and bucket movements.

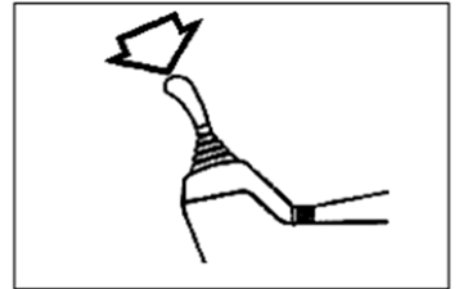

4.9.3 Dozer control lever

Control lever of dozer blade on the right side of seat is used to control the stretch of dozer blade and undercarriage. When the instrument displays the dozer blade, loosen the control lever and it will be back to the neutral position automatically, the dozer blade will stop immediately.

- o post-pull control lever dozer blade lifting
- o front-push control lever dozer blade lowering

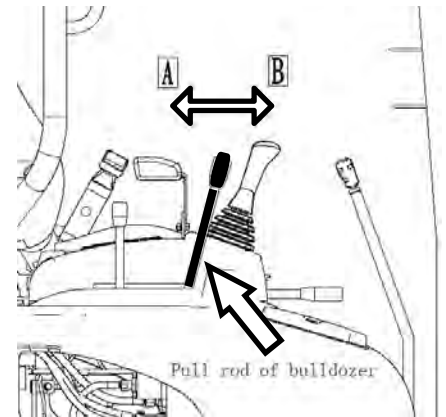

4.9.4 Auxiliary pressure port pedal “auxiliary pressure port specification”

Be used to operate breaking hammer and other working device. Among the model with auxiliary pressure port specification, press the pedal leftward, the hydraulic oil will flow to the left side (A) (look from the side of operator); press the pedal rightward, the hydraulic oil will flow to the right side (B) (look from the side of operator).

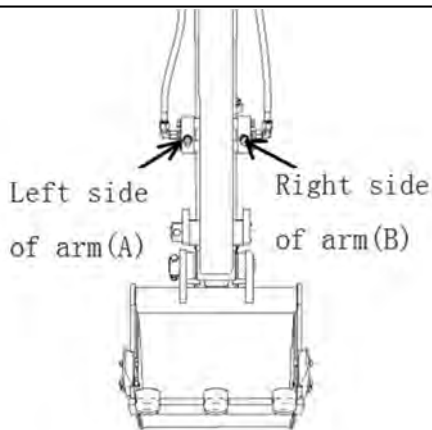

4.9.5 Wheel track

When the instrument displays the stretch of undercarriage, loosen the control lever and it will be back to the neutral position automatically, the undercarriage will stop immediately.

- A. Post-pull control lever undercarriage becomes wider (990mm→1240mm)
- B. Front-push control lever undercarriage becomes narrower (1240mm→990mm)

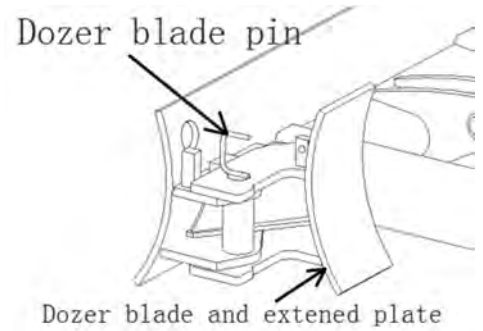

Caution: While conducting the wheel base stretch, please do it when the maximum outreach is 1240mm and the maximum retraction is 990mm. If the stretch operation is stopped in halfway, the rotating frame will shake due to that the adjustable leg is unfixed.

Please conduct the wheel base stretch only when passing smooth and narrow place.

In addition to these place, when conducting the operations of travelling, digging, bulldozing and breaking, please make sure to stretch the wheel base to the maximum width.

Or else, it will cause turnover when travel with narrow wheel base.

Notices

When there are obstacles against the stretch of wheel base, please remove the obstacles or move the machine to the flat ground and then do the wheel base stretch. If the wheel base stretch still cannot be done, please use working device and dozer blade to make the crawler impending and then conduct the wheel base stretch. In addition, if there is soil stuck into the stretch parts, please remove the soil.

4.9.6 Boom deflection pedal

Before operating the boom deflection pedal, please turn down the anti-misoperation pedal first, and then press leftward to make the boom deflect leftward and rightward to make the boom deflect rightward.

After completing the operation, turn up the cover of anti-misoperation pedal to avoid misoperation and cause personal casualty.

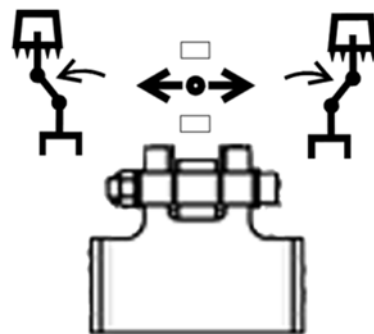
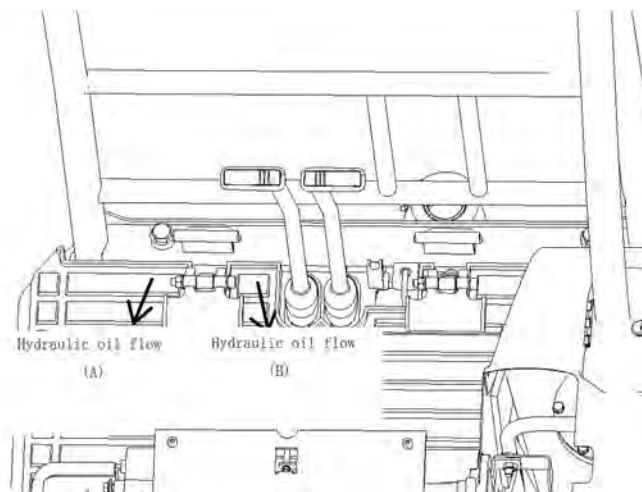

4.9.7 Display and button unit

(See section 5.4 for detailed functions and usage)



4.9.8 Engine starter switch

(See section 4.9.13.2 for detailed function and usage)



4.9.9 Operator's seat

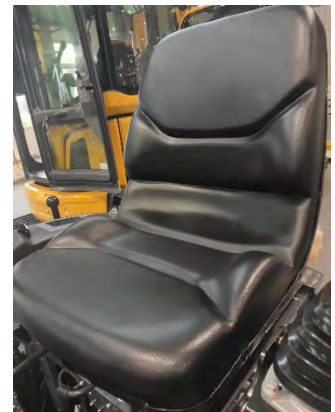

4.9.10 Engine speed control lever

This engine speed control lever adjusts the engine speed. The limits are:

A. push the lever forward: Low Speed (the lowest engine speed)

B. pull the lever backward: High Speed (the highest engine speed)



4.9.11 Left joystick

This joystick controls the arm and rotational movements.

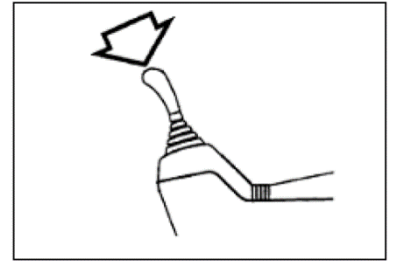

4.9.12 Safety lever

Used to lock the machine to prevent misuse or unforeseeable movements



4.9.13 Monitor and switches (refer to section 5 for purpose during operation)

- When the **engine starter switch** is set on “I” position (**power “on”**), the control system will do a self-check.
- At this moment:
 - o All signal lights should light up
 - o A beep sound should be heard for 2s

NOTE:



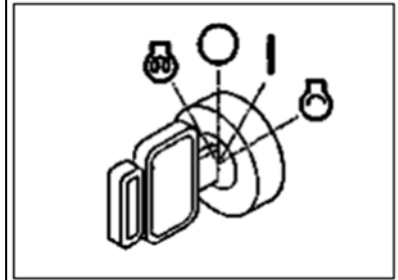









- Inform the maintenance staff right away about any light that is not lit at this time and have them fix the problem as soon as possible.
- Stop operating the machine if the encountered issue is judged too critical by the maintenance staff.













4.9.13.1 Functions of the display and button unit



<ul style="list-style-type: none"> 1. Gear display 2. Coolant temperature gauge 3. Coolant temperature indicator 4. Fuel stock indicator 5. Fuel gauge 6. Travel speed indicator 7. Menu/Back button 8. Confirm/Silence button 9. Function selector button 10. Right direction button 11. Upward direction button 	<ul style="list-style-type: none"> 12. Downward direction button 13. Left direction button 14. Function selector button 15. Silence indicator 16. Auto idle speed indicator 17. Aux mode indicator 18. Work hours display 19. Fault code display 20. Clock display 21. Pre-heating indicator
--	--

Functions and descriptions	Button Icons
1) Menu / Back button – Enter menu operation / return to the previous menu, delete figures	
2) Function selector button – Functions differ depending on the display shown	
3) Function selector button – Functions differ depending on the display shown	
4) Confirm / Silence button – Apply/confirm the selected option/function in the current menu – Used only when reaching the alarm amount under the main interface.	
5) Rightward button – Move the display cursor rightward and browse between line-wise arranged options or functions.	
6) Downward button – Move the display cursor downward and browse between column-wise arranged options or functions. – Reduce values when customly setting parameters that have digits	
7) Upward button 1. Move the display cursor downward and browse between column-wise arranged options or functions. 2. Increase values when customly setting parameters that have digits	
8) Leftward button – Move the display cursor leftward and browse between line-wise arranged options or functions	
9) Engine oil pressure fault code – The indicator lights when the oil pressure of the engine becomes too low. <ul style="list-style-type: none"> ○ When the key switch is turned to the "I" –position (power "on"), the indicator lights up; when starting the engine, it automatically turns off simultaneously with all other indicators ○ If the indicator lights up and the warning buzzer sounds during operation, shut off the engine immediately and check the engine's lubrication system. Keeping the engine on may damage it. 	
10) Auto idle speed indicator – Enables auto idle speed mode. <ul style="list-style-type: none"> ○ When no operating, the engine speed will be automatically set to low-speed status. ○ When operating, the engine speed will automatically raise up to throttle speed. 	
11) Travel speed indicator – The indicator lights up according to the mode of the travel high or low speed.	
12) Air filter fault code – This indicator lights up when the air filter is clogged and is followed by the buzzer's sound. – If it happens, clean or replace the filter if needed. After that, turn the system back on.	

<p>13) Preheating indicator(s)</p> <ul style="list-style-type: none"> - When the ambient temperature is low (below 0 °C), the engine ECU automatically controls the preheating of the engine, and a indicator will appear in the display. 	
<p>14) Battery (charge) fault code</p> <ul style="list-style-type: none"> - The monitor shows A501 if: <ul style="list-style-type: none"> o The generator does not charge the battery. o The monitor display fails to indicate the charging. <ul style="list-style-type: none"> o Check both of them, and have them repaired if necessary. 	
<p>15) Display monitor</p> <ul style="list-style-type: none"> - Shows all important status information of the excavator - Also shows all abnormalities and the related warnings indicating their occurrence - The indicators on the display also light up or flash when abnormalities happen 	
<p>16) Fuel stock indicator</p> <ul style="list-style-type: none"> - When the fuel level is less than 10%, the indicator on the display flash and the fault code "A302" starts to flash at the same time. 	 
<p>17) Coolant temperature indicator</p> <ul style="list-style-type: none"> - When the coolant temperature is more than 105°C, the indicator on the display flash and the fault code "A301" appear in the fault code area. 	 
<p>18) Aux mode indicator</p> <ul style="list-style-type: none"> - The indicator lights up according to the mode of the auxiliary implement. 	
<p>19) Spare power</p> <ul style="list-style-type: none"> - The spare power supply used the cigarette lighter in the cabin. - Confirm whether the device's operating voltage matches the machine voltage before use. - Using this device with excessive power may cause the fuse to blow. - Unplug the device to overhaul the fuse in case of a function failure. 	
<p>20) CAN fault code</p> <ul style="list-style-type: none"> - When the fault code "E4030" appear in the fault code area, the CANbus faults and contact the skilled personel immediately. 	

4.9.13.2 Frame light switch

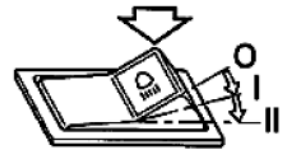

This switch is used for turning on/off the frame light.

- **O.** In this position, the frame light turns off.
- **I.** In this position, the frame light turns on.



4.9.13.3 Key switch

The key switch has four levels arranged from the left to the right in the following order, each having their respective function:

- 1)  position: used for electric preheating in freezing days
 - 2) **“O” position (Engine “off”)**: In this position, the engine flames out, and the electrical system powers off. However, cabin lights injection pump (if equipped) still work.
 - 3) **“I” position (full power supply)**: In this position, the device provides power for the whole vehicle.
 - Switch to this position before turning the engine “on”.
 - Check if both the battery charge indicator and oil pressure indicator light up by default.
 - 4)  position (**engine “on”**): This position starts the engine. As you let it go, the key reverts to the "I" position.
-  position (**electrical preheating/warm-up**):
- Switch to this position when ambient temperature is below 0°.
 - When the warm-up process is over, the preheat indicator will light up on the instrument panel.

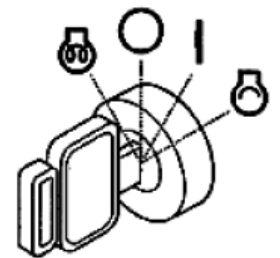

Warning!

To avoid damaging the ignition device, keep the key for less than 15 seconds in the engine start position.



Warning!

When the preheating machine is in use, failure to use starting liquid for the preheating machine can make the starting liquid explode

4.9.14 Other electrical devices inside the cabin

4.9.14.1 Joystick (the pilot shut-off switch) shut-off switch

The safety lever which mounted on the left control console can close or open the pilot oil circuit of the excavator.

- When the safety lever is on the locking position, the lever shuts off the joystick's functions and makes it unusable. The whole equipment cannot be operated under this condition.



4.9.14.2 Device mounting panel assembly

Electrical mounting plate assembly is located on the front side of the engine compartment.

The fuse box is equipped with a variety of fuses to prevent overload or short circuit of electrical equipment and devices.

The labels inside the box indicate which device each fuse belongs to.

Note: See section 6.9.2 "Fuse Category" for more information.

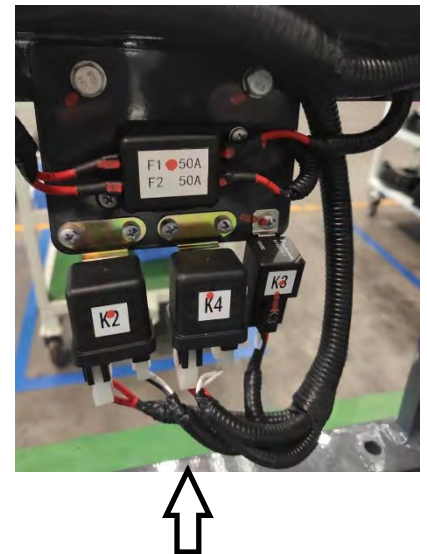

The spare fuse(s) is/are located inside the fuse box's cover.

- If an electrical component is not energized, replace the fuse.
- If there is still no current, have the circuit checked/repared



 Warning!	<ul style="list-style-type: none">– When replacing a fuse, make sure to use one that has the same electric current magnitude.– Otherwise, a fire accident may ignite in the wiring or other circuit elements due to overheat– Only use the manufacturer's original spare parts
---	--

4.9.15 Driver's Seat

 Warning!	Safety advice
	<ul style="list-style-type: none">– When switching the operator or operating conditions on the machine, make sure to readjust the seat for a safe and comfortable use.– It can only adjust the seat when the safety lever is put on the locked position.
	<ul style="list-style-type: none">– Adjust the front and back position of the seat in this area– When the required position is reached, release the control rod.– Adjustment range limit is 100 mm.



 Warning!	Advice for seat belt
	<ul style="list-style-type: none">– Snap the belt correctly in the designated slit and to buckle up firmly enough to guarantee your safety during operation– Before starting to operate the machine, adjust the seat to your size for safe and comfortable use.– The safety belt must be adjusted and snap into the designated place so as to reduce the possibility of accident or the injury degree.– Only operate the machine when seated– Avoid adjusting the seat during operation as you may lose control over it and injuries– When buckling up, check the safety and the fixing frame for any sign of wearout or damage.– Replace damaged or broken safety belts.– Do not use a twisted safe belt or twist it by yourself

4.9.16 Recommended use of machines

- Select the appropriate machine, equipment and ancillary devices for your purpose/task.
- Replace damaged seats only by equivalents manufactured by XCMG.
- Always adjust the seat and the suspension frame according to the size and weight of the operator before operating the machine.
- Inspect the seat's suspensions regularly.
- Contact the maintenance staff if you notice wearoffs or broken parts in the seat's mechanism (e.g.: looseness of screws or broken gear teeth).
- In case of recent faults, make sure maintenance and repairs on the machine was done thoroughly.
Especially regarding Tyre pressure, brakes, steering gear, crawler tracks and so on.
- Always operate the machine carefully to minimise the wearoff process and the frequency of repair needs. e.g.: steering, braking, accelerating, changing gears, moving the boom, arm or the bucket/knapper)
- Adjust machine speed and traveling paths to achieve a minimum level of vibrations to minimise the risk of irreversible health conditions.
- Drive bypass obstacles rough terrain if possible.
- If bypassing is not possible, slow down when driving through rough terrain.
- Keep the machine's working and traveling area in good shape to avoid damages while operating. (e.g.: remove large rocks or obstacles being in the way).
- Plug the ditches and potholes and even the ground thoroughly to prevent risk of injuries.
- Always select the machines according to their intended use.
- Include the ground maintenance into the project schedule.
- Keep moderate speed when traveling longer distance (e.g.: on the road)

Adjust the gear to the road surface and traffic situation to avoid sudden accelerations

4.9.17 Safety lever

 Warning!	<p>Safety rules to shut off the machine/leave the seat</p>
	<ul style="list-style-type: none"> - Push the left lever completely to lock the safety lever. - Whenever you leave the seat, be sure to shut off the engine and lock the safety lever. <ul style="list-style-type: none"> ▪ Otherwise, an accident may happen when a piloting device is accidentally moved. ▪ The machine may also move on its own if not secured this way.
	<ul style="list-style-type: none"> - When lifting or pushing the safety lever, be careful not to move the operating handle. - The safety lever is used for locking the working lever, so even an accidental movement of the working lever occurs, the machine will still not work. <ul style="list-style-type: none"> o Pull the safety lever (1), and confirm that the safety lever is locked in the raised position. o When the safety lever is in the locked position, even when you move the handle, the front working, rotary or travel mechanism does not operate! <p>Note: Lower the bucket (front working mechanism) to the ground. All operating levers are adjusted to the middle position to stop the engine.</p> - Push down the safety lever to the unoack (released) position before starting work.

Notice	<ul style="list-style-type: none"> - Though the engine may be shut off, if the the safety lever is still up and the start switch adjusted to the "ON" position, the lever can still be moved a bit due to the residual power in the accumulator. - That means any hydraulic part may still move, even though the idle machine itself will not. - Avoid starting or putting people in the immediate vicinity at risk by moving the machine parts carelessly using the residual power while the engine is turned off.
---------------	--

Notice	<p>If the equipment still moves when all control elements are in the centered "idle" position</p> <ul style="list-style-type: none"> - Switch the safety lever back to the "lock" position and shut off the engine immediately. - Contact an XCMG dealer to report the machine's failure.
---------------	---

4.10 Crawler Type Selection and Applications

 Caution!	<ul style="list-style-type: none"> – If you are not sure about the the floatability and grounding pressure regarding your crawler, choose the narrowest possibly available. – If the used crawler is wider than needed, it will unnecessarily increase the load stress on itself, become bent or loosen up. The link or pin-axis may even break.
---	--

	XE17U	
	Technical specification	Type
Standard	Rubber crawler block	C
Optional	230mm double grouser shoe	A

 Warning!		Restrictions and advice for use
Crawler Type	Suitable situation	Rubber crawler and rubber crawler blocks cannot be used on ground made of gravels and stones.
A	Stony ground, riverbeds, common earth	If the ground has big obstacles, like cobble, down-tree and rough ground, using the low speed to travel.
B	Common earth, soft ground	Only can use the high speed and medium speed on the level ground; if passing the obstacles cannot be avoided, slow down the machine and use the half speed of the low speed to travel; cannot be used on the rough ground with cobble and down-tree.
C	Asphalt ground	Only this type can be used when the driver is forbidden to damage the ground on its path.

4.11 Hammer-Type Knapper (Optional) Application

- Choose the appropriate hammer-style knapper for the available machine.
- Refer to the operational instruction for use and the hammer-style knapper's documentation before installing the knapper onto the scoop lever.
- Make sure the compatibility requirements are met to minimize any risks or injuries or equipment damage.

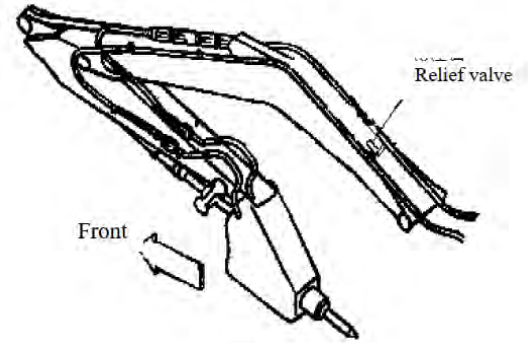

Basic Machine		Hammer-style knapper
Type	Arm	Standard Weight, kg
XE17U	Standard	33

Refer to the provided diagram to install the knapper tubing properly

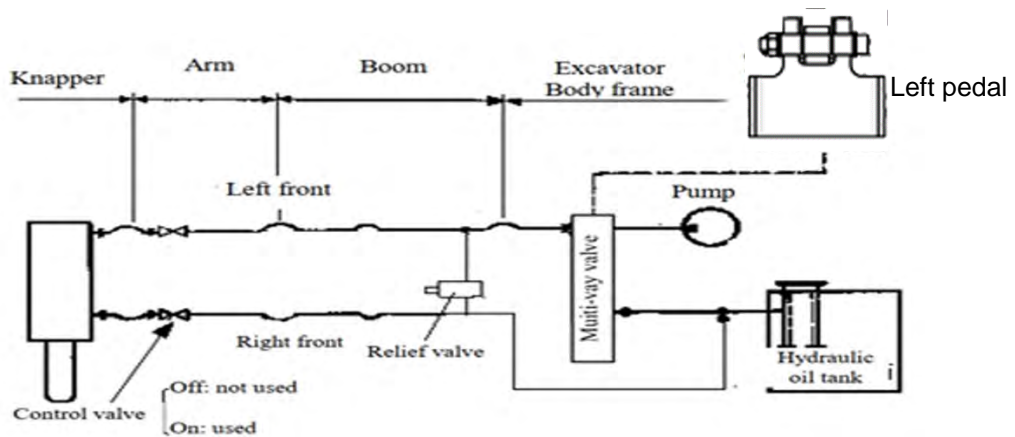

Caution!

Important: when connecting tubes of the hammer-style knapper, pay close attention to the following advice:

- While exchanging the bucket or the knapper, avoid letting dirt enter the machine's hydraulic circuit.
- While the knapper is not in use, place the lid onto the tube's inlet on top of the arm, and put the plug on the end of the knapper's hose to prevent the dirt from entering the machine.
- Keep the standby (spare?) lid and plug inside the toolkit to have them ready for replacement.
- Check the connecting seal for any oil leakage or low flexibility of pipe connectors at the end of the connection process.

4.11.1 Hammer-Style Knapper – Weight Data

Notice	Weight of hammer-style knapper
	<p>Installing components other than the standard bucket on the machine, may change its stability and balance:</p> <p>→ If attached, heavy interchangeable equipment may:</p> <ul style="list-style-type: none"> - affect the controlling ability and/or - put the machine out of balance by shifting the center of gravity, leading to additional potential risks. <ul style="list-style-type: none"> – Before installing the knapper-style knapper, make sure to consider its influence on the machine's handling to additional weight and other factors. – Refer to the document called "<u>Hammer-style knapper specifications list</u>", as well as the list below to choose the proper hammer-style knapper designed for this machine model. – While putting on the knapper with the maximum weight listed below, do not attach it while the upper structure is turned to the side. – Avoid operating the machine at the maximum stretch range to prevent destabilisation.

4.11.2 Hammer-Style Knapper – Specifications

Notice	Specification of hammer-style knapper
	<ul style="list-style-type: none"> – Mind the changes in the machine's total weight and the shift of the gravity center when using interchangeable equipment other than the standard bucket. – Attaching equipment incompatible to the machine model may damage not just the interchangeable equipment, but also the machine's body. It also increases the risk of injuries done to the operator – Refer to all relevant documents to prevent any accident! – The following list shows several hammer-style knapper, which can be fixed on XCMG excavators. Before the adoption, please inquire the dealer of hammer-style knapper in earnest.

Type of Excavator	XE17U
Knapper Producer	Yantai EDDIE Precision Mechanical Co., Ltd
Type of Knapper	EDT200
Weight, kg	95
Oil Capacity, L / min	20~30
Operational Pressure, MPa	9~12
Designed Pressure of Valve, MPa	15

4.12 Working Loads – Operational Weight Data

Material	Low density ≤1100kg/m ³	Intermediate density ≤1600kg/m ³	High density ≤2000kg/m ³
Charcoal	400		
Coke	500		
Coal, asphalt	880		
Coal, stone coal	900		
Dry ball clay	1000		
Wet clay of raw subgrade			1750
Dry particles of common concrete		1500	
Dolomite fragments		1500	
Dry or soft soil		1200	
Firm and dry soil		1500	
Wet muddy soil			1750
Burned lime paste (hot powder)	960		
3" crushed lime paste		1500	
Overstacked dry gravel fragments			1800
Overstacked wet gravel fragments			1900
At least 2-class limestone		1300	
Crushed limestone		1500	
Good limestone		1600	
Rock phosphate		1300	
Salt	930		
Small-density snow	530		
Dry and soft sand		1500	
Overstacked wet sand			1900
Broken shale		1400	
Broken sulphur	530		

Note: the weight is an approximate value of estimated average volume and capacity.

5 Operation

Notice	Operating Rules - Operating Instructions for new machines and machine scope	
	Altitude:	below 2000m above sea level
	Ambient Temperature:	-15°C to +40°C
	Job Object:	3 or less grade soil level and loose materials
	Soil conditions	Ideally solid and flat. slopes up to 15° upwards are ok
	Working environment:	Non-swampy
	<ul style="list-style-type: none"> – All excavators must be inspected and adjusted before delivery by the manufacturer or his authorised representative. – The following steps must be followed during initial start-up process and/or the running-in period. – Ignoring them may damage the machines or produce other negative impacts on their performance. 	





5.1 Follow the rules regarding operating hours

Time	Load
First 50h	Maintain 60%-70% of full load (engine speed: 60%-70% of rated speed)
After 50h	Full load



⚠ Caution!	<p>Advice for a safe running-in period</p> <ul style="list-style-type: none"> – Avoid working at full load within the running-in period (first 50h of service) → It will affect the lifetime and safe operation of the machine, eventually leading to accidents! – Check the coolant, fuel, engine oil and hydraulic oil every day for leakage. – Check the lubricating liquids every day and refill them if needed. – During operation, always observe the information and indicators given on the display and the various meters. – Avoid engine overload. – Keep below 80% of the maximum load until the engine and other components have reached the standard working temperature. <p>During operation, keep watching over proper function of the machine.</p> <ul style="list-style-type: none"> – Check for looseness, wear or damage caused during delivery. – Check the wires and terminals for looseness, the meters for abnormal values, and the battery's electrolytes for concentration. – Check the lubricating liquids and filter elements for contamination, dirt or damages.
-------------------	---

Notice	<ul style="list-style-type: none"> – When changing the lubricant or grease, refer to the “Maintenance” section of this instruction for use.
---------------	--

5.2 Start and Shutdown

 Warning!	<ul style="list-style-type: none">  Keep combustible materials like tree leaves, paper, etc. off the high-temperature components such as the muffler to prevent fire.  Keep in mind that any leakage of fuel, lubricant or hydraulic oil may also cause a fire.  Prevent big damage and/or serious injuries.
---	--

Notice	Before starting the engine, check the following items:
	<ul style="list-style-type: none"> – The wiring: check and repair/replace any damaged/loose wires or missing/damaged terminals. – The fuel machine: drain out or remove any water or other foreign materials from the fuel tank and the water separator. – Hydraulic machine: Check hydraulic oil for leakage, pipes for damages, and components for interference. – Lubrication: Perform routine service and maintenance thoroughly and regularly; according to the timer's reading. – Liquid level: Check the hydraulic oil level, the coolant level in engine radiator, and the engine oil for their intended level. In case of abnormalities, refill or drain until it reach the intended height. – Safety of surroundings: Check the machine's vicinity. – Make sure nobody is located in any blind spot or is performing maintenance/repairs before ignition. – After start: Check all control levers and indicators for unusual stiffness or values. – Before work, shut off the engine again to service the abnormal functional units.

 Warning!	Operation inspection before start
	<p>When leaving the seat, set the safety rod to locked position to avoid accidents caused by moving any control advertently. Proceed in the following order:</p> <ol style="list-style-type: none"> 1. Set the safety rod to “locked” position. 2. Check if working conditions and other situations are normal. 3. Make sure that the travel control levers and the control lever are in their neutral position.
	<p>Notice: When starting the engine, do not to touch any other control or switch.</p> <ol style="list-style-type: none"> 4. Turn the engine starter switch to “I” position and check if all indicator lights are turned on. 5. After 2 seconds, make sure the following lights are still on. <ul style="list-style-type: none"> • Engine coolant temperature gauge • Charging alarm light • Fuel gauge • Engine oil pressure alarm light

5.2.1 Engine Start

 Warning!	Follow the steps in the designated order.
---	--



1. Follow the steps in “operation inspection before start” (Begin of section 5.2).
2. Sound the horn.
3. Make sure that there is nobody or obstacles in the swing range area
4. Carefully push the engine speed control lever forward.



Warning!

In case that engine start fails, turn the starting switch back to “OFF” position, and wait for 2 minutes before the next attempt.

Notice

Retrying right away after a start failure will damage the coil in the starter and cause the battery to fade.

Notice

Starting in freezing days

1. Set the engine accelerator rod to a place slightly higher than the “minimum idle speed” position gently.
2. Turn the starting switch to warm-up position till the preheat indicator lights up.
3. After the preheat indicator comes on, turn the starting switch to START position immediately.



Warning!

If the engine fails to start up within 15 seconds, release the starting switch key, and then repeat the above steps after 2 minutes.

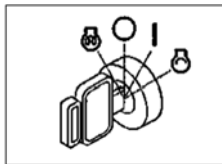

1. Turn the key switch to “I” position and check if all indicator lights light up.
 - The meters will adjust, and the warning buzzer will sound for 2 seconds.
 - If any indicator does not turn on at this moment, check for the reason and replace it.
 - Contact an XCMG maintenance agent otherwise and stop using the machine immediately.
2. Check all the indicators and gauges. After 2 seconds, all indicators will go out except the following ones.
3. Sound the horn and make sure that there is nobody or no obstacle in the work area.
4. Set the key switch to start position and the engine should start up within approx. 5 seconds.
5. After engine start, release the key and it will return to “I” position.

SN	Fault codes or gauges on the display	Indicate readings
1	Fuel gauge	Normal zone
2	Engine coolant temperature gauge	Normal zone
3	Engine oil pressure fault code A304	Fault code zone
4	Battery charging fault code A501	Fault code zone

5.2.2 Warm-up of Hydraulic System

 Warning!	<ul style="list-style-type: none"> – In case of malfunction or abnormal operation, shut off immediately. – Before work, let the engine reach the usual work temperature, especially in freezing days.
---	---

Notice	The ideal working temperature of hydraulic oil is 50~80°C (120~175°F).
Warm up as follows:	
	<ol style="list-style-type: none"> 1. Run the engine at middle speed without load for 5-10 minutes until the operating temperature has been reached. 2. Set the safety lever to “unlock” position. 3. Move the arm, boom and bucket cylinders for 5 times slowly to circulate hydraulic oil in the machine without load. The duration of this operation is 5 minutes. 4. Check the clearance of the equipments (bucket, arm and boom) and lift them completely. Then swing the upper structure clockwise and counterclockwise for 3 turns each. 5. Swing the upper structure until it is in standard position (vertical to the undercarriage). Lift the crawler off ground and move back and forth. Then drive the travel motor for 2 turns (1 turn at high/low speed each). 6. Repeat step (5) for the other crawler.

Notice	Hydraulic machine warm-up in freezing days
	<ol style="list-style-type: none"> 1. Run the engine under idle speed without load for 5 minutes. 2. Run the engine under medium speed without load for 5 minutes. 3. Set the safety rod to “working” position. 4. Move the arm, boom and bucket around slowly without load about 5 times to circulate the hydraulic oil inside the machine. Do this for about 5 minutes 5. Increase to engine’s maximum speed. 6. Repeat step (4) for about 5 minutes. 7. Lift the equipment (bucket, arm and boom) completely to check clearance, then slowly swing the upper structure clockwise and counterclockwise for 3 turns each. 8. Swing the upper structure until it is normal to the undercarriage. 9. Then lift the crawler off the ground and move back and forth. 10. Finally drive the motor for 2 turns (1 turn at high low speed each). 11. Repeat steps (9) and (10) for the other crawler. <p>Note:</p> <ul style="list-style-type: none"> – Do not let the cylinder hold out pressure for more than 20 seconds. – If the rotation speed is still low, continue operation, but take particular care in case that the equipment’s performance becomes unstable.



 Warning!	<ul style="list-style-type: none"> – In case of malfunction or abnormal operation, shut off the engine immediately. – Before work, let the engine reach the usual work temperature, especially in freezing days.
---	--

5.2.3 Shutdown

Notice	Follow the steps’ order as shown below
---------------	--

	<p>Before shutdown, run the engine under idle speed for 3-5 minutes to prevent damage to the engine due to heat accumulation. Idling helps cooling down faster.</p> <ol style="list-style-type: none"> 1. Park the machine on a firm, flat ground. 2. Lower the equipment (bucket, arm and boom) to the ground and make sure that all control levers are in neutral position. 3. Pull up the safety lever to set it to the “locked” position. 4. Set the engine speed control lever to “idle speed” position and leave the engine running idle for 3-5 minutes. 5. Turn the key switch to “O” position to shut off the engine. 6. Turn the key switch back to “I” position to turn on the power without starting up. 7. Push the safety rod down to set it to “unlocked” position. 8. Move each of the control levers around to release residual pressure of the hydraulic machine. 9. Pull the safety lever up again on the “locked” position. 10. Turn the key switch back to “O” position to shut off the engine. 11. Pull out the key. <p>Note:</p> <ol style="list-style-type: none"> 1. When the engine is shut off, excavator and equipment (bucket, arm and boom) or attachments must be set according to the parking requirements, in case that the devices will fall and hurt machine or people because of sliding or slow action. 2. When the machine is parked for a short time, check the parking area before parking, make sure the exposed people will not be hurt if the equipment (bucket, arm and boom) and attachments fall or move on its own.
	<p>Confirm checks after shutdown</p>
	<ol style="list-style-type: none"> 1. If coolant or oil leaks, fasten them, or if still leaking, contact skilled personnel. 2. Check the equipment (bucket, arm and boom) and the undercarriage for anomalies and/or troubleshooting 3. Refuel. 4. Remove combustible materials accumulated in engine portion, such as tree leaves, wood sticks or paper. 5. Clear the mud out of the crawler’s and the machine’s bottom. Keep all pedals and levers clean inside the cabin.

5.2.4 Jump-starting the excavator

 Warning!	<p>The battery generates explosive gases while charging or being used. Keep the area around it free of sparks or static electricity.</p>
	<ol style="list-style-type: none"> 1. Charge the battery at a well-ventilated place. 2. When starting a facility with jumper cables, wear safety goggles. 3. Wrong jump-starting procedure may result in an explosion and cause severe injuries. 4. Start on a dry and firm ground but avoid ungrounded metallic roads or surfaces. 5. When starting with other equipment connected, make sure that the facilities do not contact. 6. When charging, connect the positive pole of the subsidiary battery to that of the feeding battery and the negative pole of the former to bracket of the latter. 7. When installing the battery, connect the positive connection poles first, when dismantling it, start by removing the negative pole.

 Warning!	<p>The voltage of the electrical machine is 12V (negative ground). During assisted start, be sure to use a 12V boosting battery of the same capacity.</p>
---	---

5.2.4.1 Connecting boosting battery

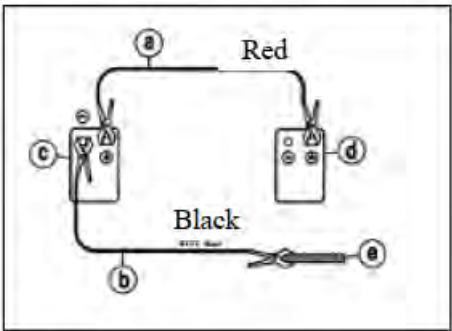
Notice	<p>When starting, follow the steps below to use the assisted or boosting battery start method after the feeding is done.</p>
	<ol style="list-style-type: none"> 1. Shut off the engine on the equipment connected with the boosting battery. 2. Connect one end of the red wire (a) to the positive pole of the battery on the excavator and the other end to that of the boosting battery(c). 3. Connect one end of the black wire (b) to the negative pole of the boosting battery and the other end to the upper bracket (e) on the excavator for grounding. 4. When connecting the upper bracket, keep connections away from the battery as far as possible and do not connect it to the negative pole of the battery directly. 5. Start the engine.

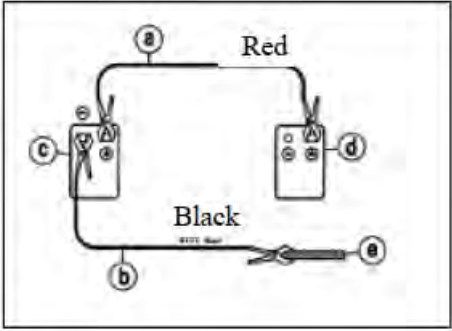

5.2.4.2 Removing boosting battery

Notice	<p>Follow the steps below to remove boost-battery.</p>
	<ol style="list-style-type: none"> 1. First, remove the black negative connection (b) from the main frame of the equipment. 2. Remove the other end of the black negative connection from the boosting battery. 3. Remove the red positive connection (a) from the boosting battery. 4. Then, remove the other end of the red positive connection (a) from the battery on the excavator.

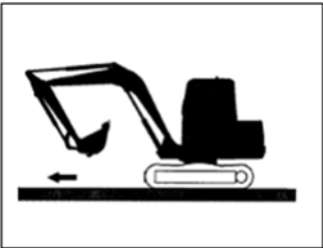
5.3 Travel Operation

 Warning!	<p>Before operating the travel control, verify the direction the crawlers are pointing to. If you cannot see the arrows located on the tracks from the cabin, swing the upper structure half a turn before starting to drive.</p> <p>Otherwise, you will have to do all the travel control levers's movements the opposite of the way you actually want to move the machine.</p>
	<ul style="list-style-type: none"> ⚠ To start a long-distance travel, swing the upper structure to let the travel motor at the rear of the canopy. ⚠ When traveling down a slope, operate the control pedals slowly. ⚠ Before travel, make sure there is nobody on the road and the excavator. Sound the horn to warn other people that the excavator is about to move. ⚠ During travel, make sure there is nobody on the road and the excavator. Sound the horn to warn other people that the excavator is about to move. ⚠ When backing up, take extra care to make sure that there are no obstacles behind. ⚠ Be sure to operate the travel control levers smoothly to avoid sudden start or stop. ⚠ Before leaving the seat, be sure to lock all control machines and shut off the engine to prevent accident

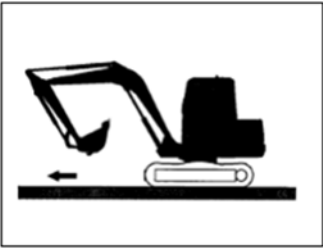
5.3.1 Overview of travel

Notice	Follow the steps in the correct order:
  	<ol style="list-style-type: none"> 1. Set the engine speed control lever to required speed position. 2. Set the safety lever to "unlocked" position. 3. Retract the front equipment until it is lifted about 40-50 cm above the ground. 4. Ensure that the bucket has been fully retracted. 5. Travel on firm, flat ground as possible and avoid sudden actions and small-angle cornering. 6. When traveling on irregular ground, select low speed travel mode to avoid receiving impact load. 7. Take care to avoid excessive stress to the equipment caused by hooking or stepping on stones. 8. Slow down when traveling on irregular, freezing or rugged ground.

Warning!

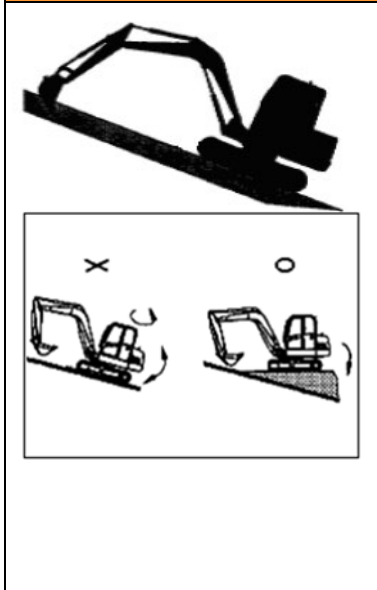

Follow the advice:

- ⚠ During travel, hold the bucket at the height with ground clearance of 40-50 cm.
- ⚠ Do not back up on a slope.
- ⚠ Do not turn or drive across while on a slope.
- ⚠ When climbing a slope, select a safe route.
- ⚠ Avoid working on a slope, to prevent a rollover due to loss of balance.
- ⚠ If the excavator starts to slip or becomes unstable, insert the bucket into ground immediately to stabilise it. (fig.1) (e.g: when swing the upper structure).
- ⚠ If work on a slope is compulsory and unavoidable, even the ground on a suitable area before resuming work with the machine.
- ⚠ Make sure that the inclination stays below 15° when working on slopes
- ⚠ Never drive a slope while carrying load.
- ⚠ Never travel on slopes exceeding 30° of inclination to avoid rollovers.

Warning

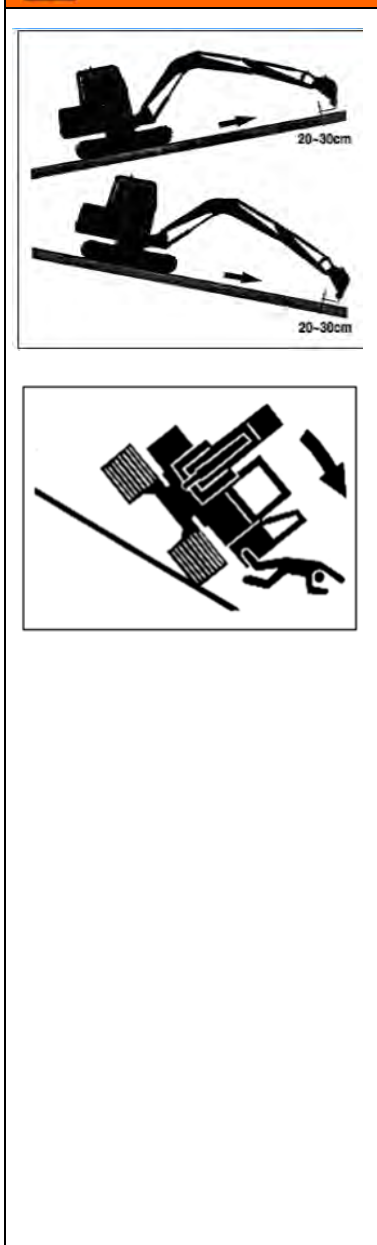

Follow advice:



- When moving on a slope, drive along a straight line with the crawlers facing the slope.
 - Do not drive across the slope diagonally. As shown in the figure below.
 - Stretch out the arm and lower the boom to hold the bucket mid-air about 30cm (12inch) above the ground. If the machine starts to slip or becomes unstable, insert the bucket into the ground to restore balance.
 - In case the engine stalls while on a slope:
 - o stick the bucket into the ground,
 - o make sure that all levers are in neutral position,
 - o try to restart the engine.
- Notice :** When on the slope, even if the engine stalls, do not swing, because the accumulator can make tilt
- Notice :** Do not open/close the cabin door while on the slope and the door must be fixed.
- If there is dust or mud on the track frame, support the crawler at each side to turn it for several turns respectively, and then make sure that the adhesive dirt has been cleared.
 - In cold climates, stop the excavator on firm ground to prevent crawler and the ground from freezing together.
 - Get rid of crumbs from track shoe and track frame. If the crawler and ground freeze together, use boom to lift the crawler, carefully swing the machine (to avoid damages of sprocket and crawler tracks).
 - If engine stops under load, remove the load and immediately start the engine.
 - Run the engine at 1200rpm for 30 seconds before loading.
 - Planks should be used to avoid damaging the road.
 - When operating the machine on an asphalt road during summer, drive carefully.
 - When traveling across a railway, use planks to avoid damaging the railway
 - Do not let the machine touch electric wire or edge of a bridge

	<ul style="list-style-type: none"> - When traveling across a river, use the boom to test the depth of it and go across it slowly. If the river is deep enough to reach the top edge of the carrier wheel, do not go across the river. - Avoid operating that may damage the crawler and components of undercarriage - During frozen climate, it is necessary to eliminate the snow and ice in the bottom of crawler before loading and unloading the machine, in case that it slides
--	---

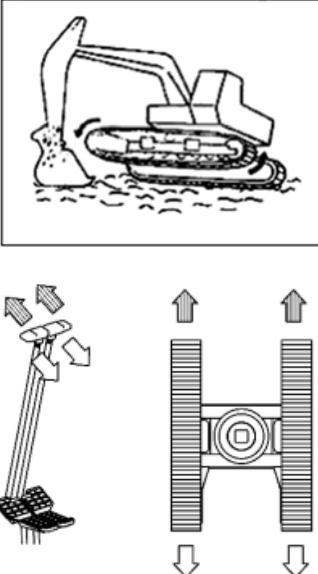
<p>Notice</p>	<p>To support any portion of the equipment with the arm and the boom, turn the bucket until its edge touches the ground. This should create angle of about 90° between the arm and the boom.</p>
----------------------	--

<p>Notice</p>	<p>The required movements to lift one of the crawler tracks mid-air should be performed with care and precision.</p>
	<ol style="list-style-type: none"> 1. Swing the upper structure by 90° to place it normally to the crawler. 2. Keep the included angle between the arm and the boom at about 90°~110° and turn the bucket until its edge touches the ground. 3. Operate the boom downwards to push one of the crawler tracks off the ground.

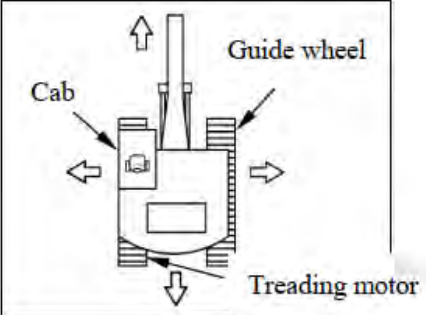
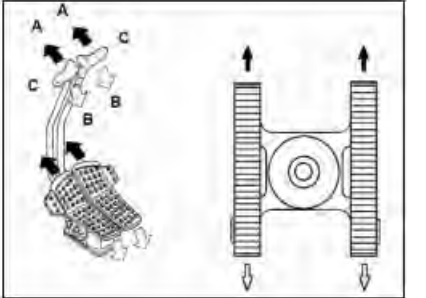
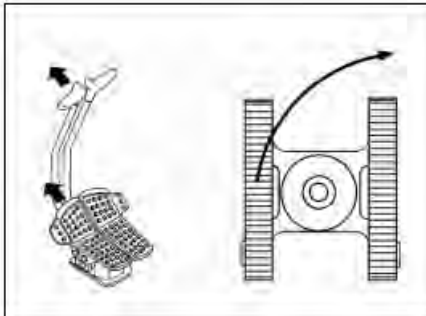
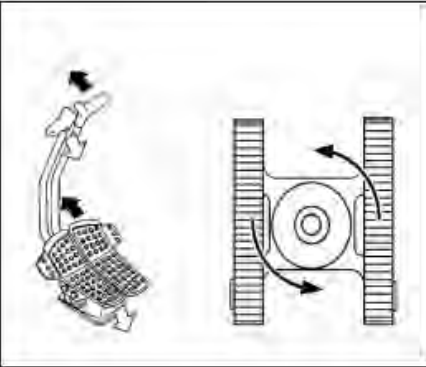
5.3.2 Operating travel control lever

 <p>Warning!</p>	<p>Follow the advice to prevent injuries due to driving in the wrong direction</p>
	<p>In standard traveling orientation, the sprocket and the cabin are on the same side, while it is in the rear part. If the engine is located on the wrong side, driving controls will be completely reversed. You will have to move the joysticks the opposite way to both turn and accelerate To avoid this, look for the arrow markers located on the track edges to make sure you are in the right direction before starting to drive.</p>
<p>Notice</p>	<p>Follow the instructions for safe driving</p>
	<ul style="list-style-type: none"> ➤ To travel forward/backward along a straight line, push/pull both control levers/pedals forward or backward. The more you push/pull the levers/pedals, the higher the travel speed will be, depending on how the throttle is set. ➤ To travel forward: Push both of the control levers forward (A). ➤ To travel backward: Pull both of the control levers backward (B). ➤ Neutral position (C): When the control levers are on the neutral position, the travel brake will stop the machine automatically.
	<ul style="list-style-type: none"> ➤ When operating one crawler to rotate forward or backward, the machine can make turns with the stationary crawler as axis of revolution. ➤ Turn right: Push left control lever forward. ➤ Turn left: Push right control lever forward.
	<ul style="list-style-type: none"> ➤ When one crawler rotates forward while the other one rotates backward, the excavator will swing with its center point as center. ➤ Spin around Push forward one control lever and pull another backward in the meanwhile. ➤ Stop travelling When the travel lever returns to neutral position, the excavator will apply brake automatically and stop.
 <p>Caution!</p>	<ul style="list-style-type: none"> - When the traveling distance exceeds 2 km, the machine should be transported using a hauling truck. - When travel distance is within 2 km, use batch process (i.e. travel for 10 minutes and then take a 5-minute break) otherwise, parts and components of the machine will be seriously damaged.

5.3.3 Travel speed control

Notice

You can select between two travel speed ranges using the travel speed switch. High and low speed switching sign on canopy, please observe carefully.

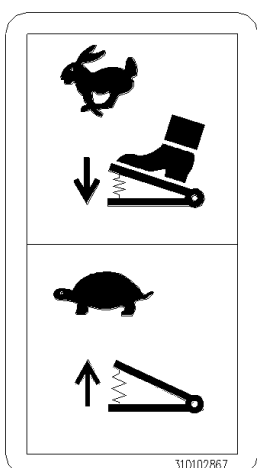

- Press the pedal, high-speed and small-torque travel speed mode is selected
- Release the pedal, low-speed and large-torque travel speed mode is selected;

⚠ Warning!

- ⚠ Rollover risk may cause serious irreversible injuries or even death.
- ⚠ Please travel at low speed, especially when going down a slope or on rough terrain.
- ⚠ Do not switch your travel mode while traveling, especially on a slope.
- ⚠ Switching the travel mode to high speed while driving will increase your risk of injuries significantly..
- ⚠ Stop the machine and check the soil condition before changing the travel mode.

5.4 Control Lever

5.4.1 Control Stand – Cabin Overview

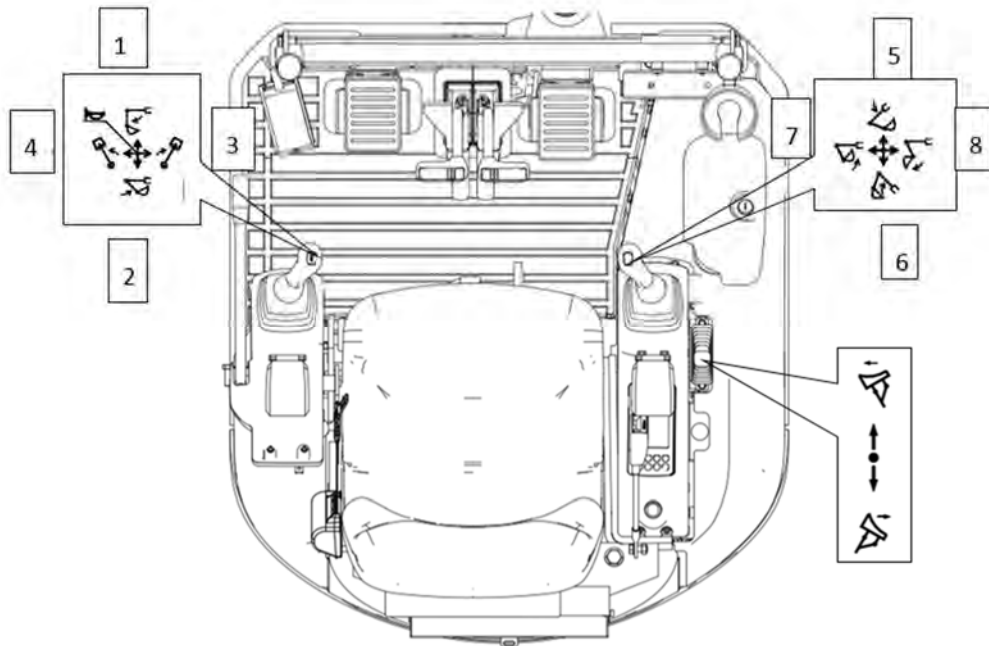

1 = dump the arm	2 = crowd the arm
3 = Swivel upper structure clockwise	4 = Swivel upper structure anticlockwise
5 = lower the boom	6 = raise the boom
7 = crowd the bucket	8 = dump the bucket

Caution!	
	<ul style="list-style-type: none"> – The control lever structure of this excavator complies with ISO standard. Do not modify such parts as valves and hoses; otherwise, the standard settings will also be modified. – There are marks showing standard control modes of control levers and pedals at right-hand side of the cabin seat. – When released, the control lever will go back to neutral position, and the relevant machine function will stop.

5.4.2 Working Control

Notice	Follow the advice
	<ul style="list-style-type: none"> – Before starting work, move the lever around slowly to check for any stiffness in the device's reactivity and sensitivity. – Do not reach out any part of your body over the window frame. – →Touching the control lever unintentionally while reaching outside may cause the working device to hurt you. – If the window is missing or broken, replace it immediately. – Know the position and function of each control element before operation.

Notice	detailed focus on the joystick's functions:

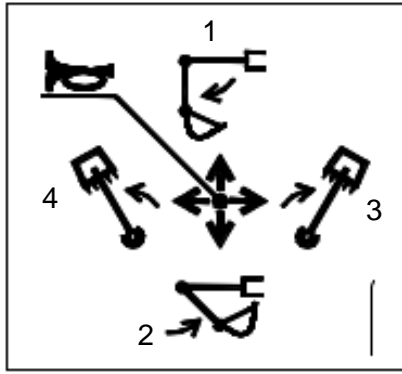

Left joystick

1. Dump thje arm
2. Crowd the arm
3. Swivel upper structure clockwise
4. Swivel upper structure anticlockwise

Notice

- The slew brake is enabled by springs and disabled by hydraulic pressure.
- When the lever is in neutral position and the engine is shut off, the brake will automatically activate.
- The pause happening before movement when the boom is actuated is not a machine malfunction. This behaviour is due to a dead weight resulting in oil supply lack.
- Beware as it will start moving faster in the next moment and be more patient instead of forcing the movement.

Notice

- The button on the top of right lever is obligated for the subsidiary equipment.
- Pressing the button may result in no response before the subsidiary equipment's activation.
- However, it doesn't mean there's no pressure inside the subsidiary equipment.
- In any case, always pay attention to operation safety.

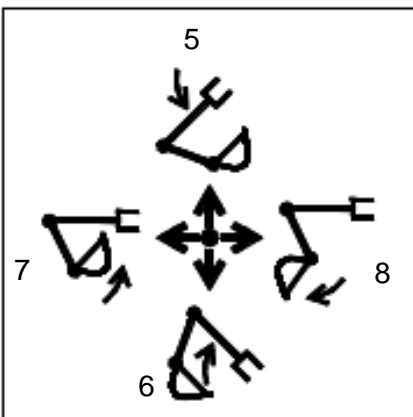

Right joystick

5. Lower the boom
6. Raise the boom
7. Crowd the bucket
8. Dump the bucket

5.4.3 Dozer Lever Control Function

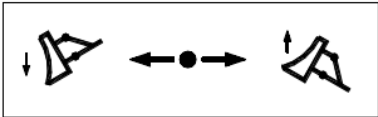
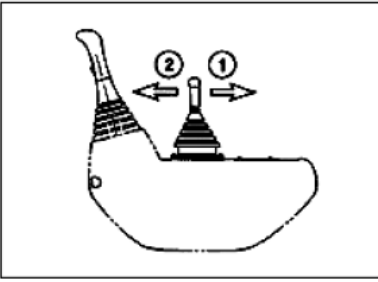
<p>Notice!</p>	<ul style="list-style-type: none"> - The dozer control lever located at right-hand side of the seat controls operations to the dozer.
	<ul style="list-style-type: none"> - When released, the control lever returns to neutral position and the dozer will stop moving immediately.
	<p>1 = pull dozer up 2 = push dozer down</p>

5.4.4 Boom Deflection Pedal

<p>Warning!</p>	<ul style="list-style-type: none"> - No person is allowed to stand in the swing area during the movement. - Swing carefully to avoid any contact of the front attachment with adjacent objects. - Depending on the model, the boom swing function is controlled with the boom swing pedal.
------------------------	---

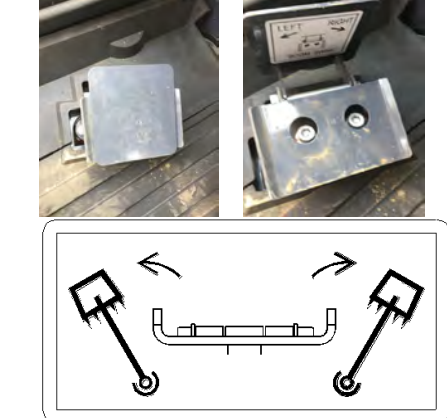
<p>Notice!</p>	<ul style="list-style-type: none"> - Before operating the boom deflection pedal, lift up the missteps-prevention plate.
	<ul style="list-style-type: none"> - Step on the pedal leftward to deflect to the left, step rightward to deflect to the right. - After completing the operation, revert the missteps-prevention plate to its original position, to avoid personal casualties.

5.5 Operating the auxiliary port

Notice!

The auxiliary port serves for operating attachments.

- Only attachment approved by XCMG may be used. The attachments must be operated in accordance with the operating instructions supplied with them.
- When using a hammer or other attachment for demolition work where material (e.g. asphalt) is removed and can uncontrollably spatter away, personal protective equipment is to be worn at all times (safety shoes, safety helmet, eye protection, ear protection and, if necessary, a breathing mask). The use of a gravel guard (front protective grid) is recommended.
- The performance data for the auxiliary port can be found in the “Technical data” section 4.11.
- Make sure that, before carrying out the activities in the auxiliary port connectors, the hydraulic system has been depressurized. Depending on the operation setting, the valve of return flow has to be set to the appropriate position.
- The auxiliary ports may only be activated when an implement is attached.
- If the auxiliary port has not been used for a long period of time, dirt particles could have accumulated on the connectors of the conduits. Before installing the attachment, drain approx. 0.1 L of hydraulic oil at each port.
- Collect the drained hydraulic oil in a container and discard it in accordance with the valid environmental regulations.

Notice!

- The machine is equipped with a hydraulic auxiliary port. An auxiliary port connector (1) is located on both the left and right side of the arm.
- The auxiliary port function is controlled with the auxiliary port pedal.
- Start the engine and idle it until the operating temperature has been reached.

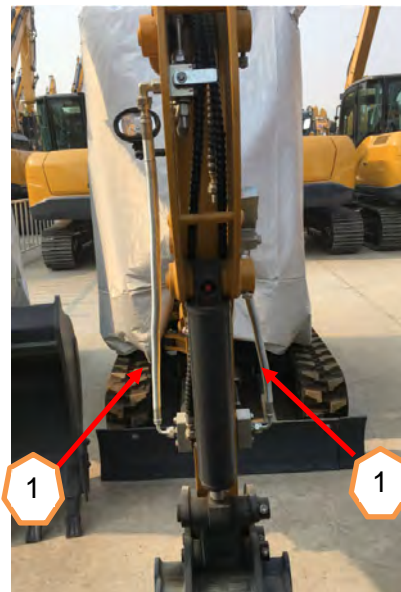

5.5.1 Accessory Implement Switch

Notice!**Operating the auxiliary ports**

- The proportional control enables you to smoothly control the implement speed. Example: If you press the rocker switch halfway to the left, the implement moves at approximately half speed.
- The "1-way" is used for hammering attachments, such as a hydraulic hammer.
- The "2-way" is used for rotating attachments, such as a rotary gripper, an auger, etc.
- The auxiliary port pedal (1) can be protected against unintentional operating by turning the locking flap (2). If the auxiliary port pedal is not used, the locking flap must be folded in.
 - o When operating the right pedal part (figure) there is an oil flow at the connector B (figure below).
 - o When operating the left pedal part (figure) there is an oil flow at the connector A (figure below).

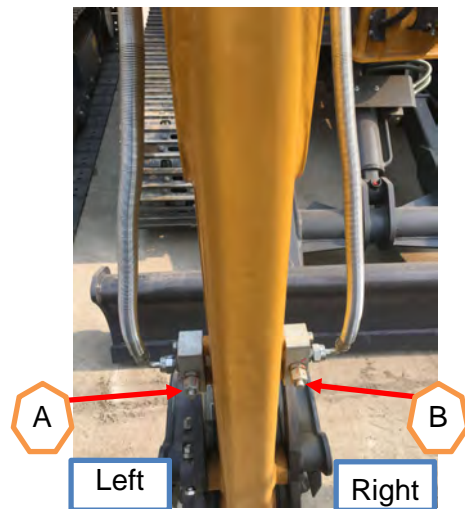
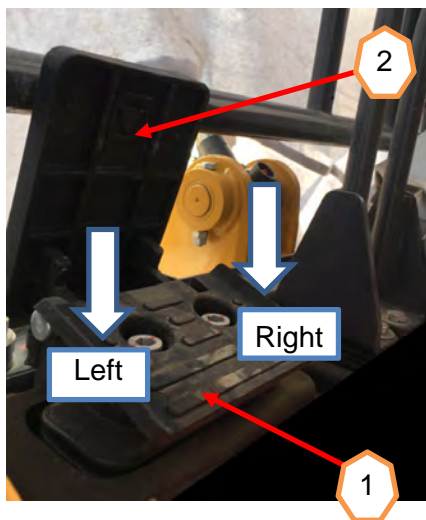

Left

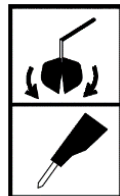

Right

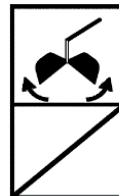

5.5.2 1-way and 2-way (combined function) setting of the auxiliary port 1

Notice!

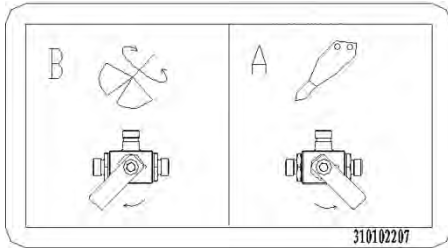

- According to the mode of operation of a given attachment, the return flow of the hydraulic oil must occur either via the control valve (2-way) or directly to the hydraulic oil tank (1-way). The return change valve for direct return flow can be activated mechanically
- The “1-way” switch position is used for hammering attachments, such as a hydraulic hammer.
- The “2-way” switch position is used for rotating attachments, such as a rotary gripper, an auger, etc.

Notice!

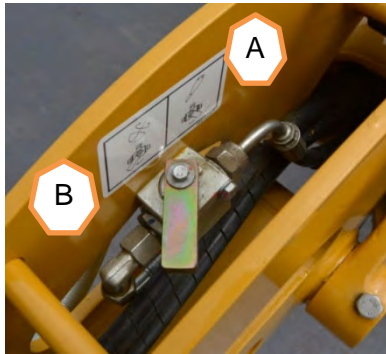

- There is a selector valve on auxiliary hydraulic lines, it has two switch positions.
- You can notice the handle carefully, there are two lines on it, these two lines towards hoses which are connected together. (The handle is in the spare parts box)
- Move the valve to the required position depending on the mechanism of the attachment being used (rotary or breaking).
- When pull the handle to “A” position, the lines are set to “1-way” mode: high pressure oil enters from the left side of the line, and returns from the implement to the hydraulic oil tank from the right side.
- When push the handle to “B” position, the lines are set to “2-way” mode: high pressure oil can enter from both side of the lines. The return flow is directed from the implement to the control valve and then to the hydraulic oil tank. In this case, return flow can be via the left or right auxiliary port connector of the arm.

5.6 Control Display Functions

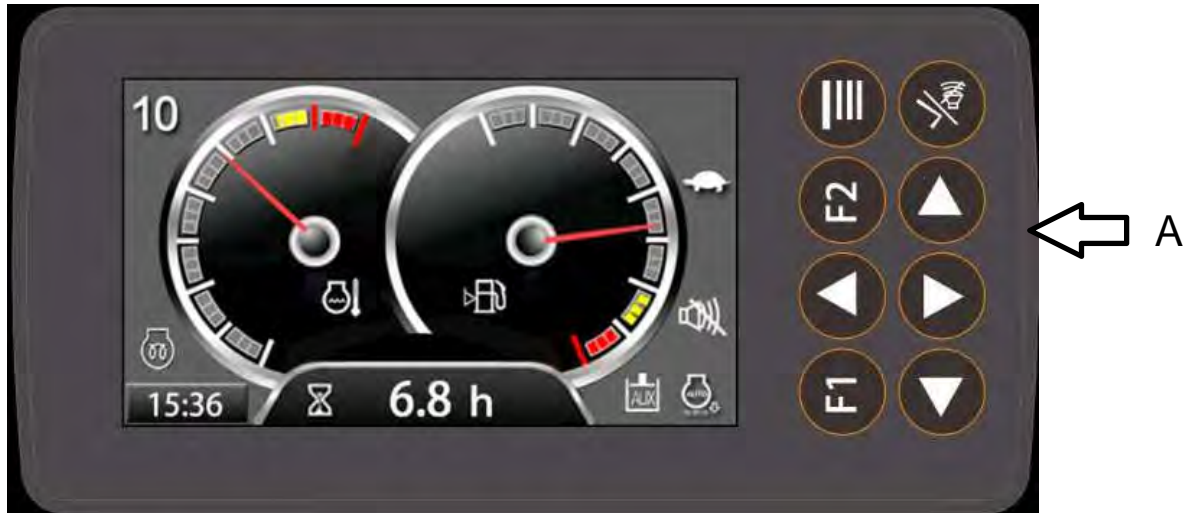











Figure5.4-1

5.6.1 Icon Description





Icon	Content	Alarm Mode	Alarm Condition
Fault code A501	Low battery voltage	Flashing + Sound	Speed > 650 Rpm Input voltage < 12.5V
		Flashing	Speed < 650 Rpm Input voltage below 12V
	Engine electric preheating	Long-time on	Connecting to system voltage
Fault code A304	Engine oil low pressure	Flashing	Ground Speed < 500
		Flashing + Sound	Ground Speed > 650
Fault code A305	Air filter	Flashing + Sound	Ground
	Buzzing prohibiting	Long-time on	User selection

5.6.2 Key Function Description



Notice!	View the buttons from ← A direction
	Function keys: function referring to interface description in each interface
	Function keys: function referring to interface description in each interface
	Menu/Return Key: Enter menu operation interface/Return to the previous menu.
	Direction key (up): Select upward and browse each function to increase the value.
	Direction key (down): Select downward and browse each function to decrease the value.
	Direction key (left): Cursor on the soft keyboard turns left.
	Direction key (right): Cursor on the soft keyboard turns right.
	Confirmation/Buzzer Forbidden Key: Perform the operation selected in the current menu/buzzer, and buzzing is prohibited (only used under the main interface when the alarm lamp turns on).

5.6.3 Main interface

5.6.3.1 Interface Information Description

- The main interface graphically displays information about engine cooling water temperature and fuel level on the analog dial, and displays engine working hours and time information in figures.
- The main interface prompts high cooling water temperature , low fuel level , and plugging of pilot oil filter  with icon flickering and fault codes.
- The main interface prompts maintenance information with icon flickering.
- The main interface displays machine mode . For details, see section 5.6.5.5.

5.6.3.2 Prompt Information Description



- When fault code (e. g. A301) occurs in the main interface (figure 1), press  to quickly enter the fault information query interface (figure 7) to view detailed fault information.
- When maintenance prompts  (with no alarm prompts) appear in the main interface (figure 1), press  to quickly enter the maintenance information query interface (e.g. 8-hour maintenance figure 9) to view the detailed maintenance information.

5.6.3.3 Interface Hierarchical Structure

Notice!



Figure 2

- 1) In the main interface (figure 1), press  to enter **Main Menu** (figure 2).
- 2) Press  again to go back to the main interface

5.6.4 User Information Query

Notice!

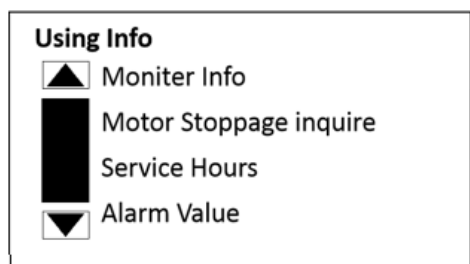





Figure 3





- 1) On the **Main Menu** page (figure 2), press   to select the user query items,
- 2) Press  to enter the **Using Information** page (figure 3),
- 3) Press  to go back to the previous menu

5.6.4.1 Monitor information

Notice!

Monitor Info	
▲	Monitor Info
	Voltage 12.1v
■	Engine Speed 0RPM
	Coolant temp 40°C
	Fuel Level Open
	Air Filter Normal
	LS oil pressure 0.0bar
	Charging Alarm
▼	Engine Oil Pressure Sw Normal

Figure 4





- On the **Using Information** page (figure 3), press   to select monitor information query items, press  to enter the **Monitor Information** page (figure 4), and press  to go back to the previous menu

5.6.4.2 Motor Stoppage inquire

Notice!

Motor Stoppage inquire				
	SPN	FMI	OC	CM

Figure 5





- On the **Using Information** page (figure 3), press   to select **Motor Stoppage inquire** query items, press  to enter the **Motor Stoppage inquire** page (figure 5), and press  to go back to the previous menu.

5.6.4.3 Service Hours

Notice!

Service Hours:	<input type="text" value="0.0h"/>
Stage Hours:	<input type="text" value="0.0h"/>

Figure 6

- On the **Using Information** page (figure 3), press   to select **service hours** query items, press  to enter the **service hours** page (figure 6), and press  to go back to the previous menu.



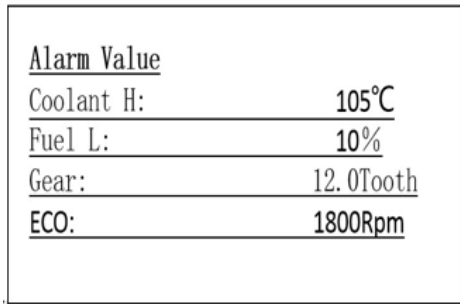

5.6.4.4 Alarm Value

Notice!



Alarm Value	
Coolant H:	105°C
Fuel L:	10%
Gear:	12.0Tooth
ECO:	1800Rpm

Figure 7

- On the **Using Information** page (figure 3), press   to select **alarm value** query items, press  to enter the **alarm value** page (figure 7), and press  to go back to the previous menu.

5.6.5 User Information Settings

Notice!

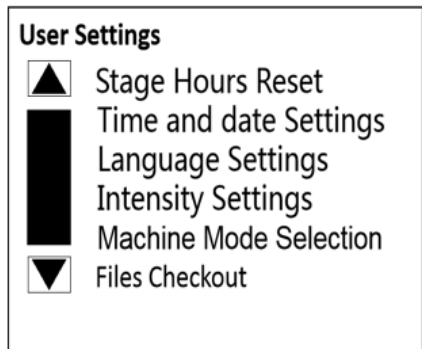











User Settings	
	Stage Hours Reset
	Time and date Settings
	Language Settings
	Intensity Settings
	Machine Mode Selection
	Files Checkout

Figure 8

- On the **Main Menu** page (figure 2), press   to select the **user settings** query items, press  to enter the **user settings** page password: 11111111 (figure 3), and press  to go back to the previous menu



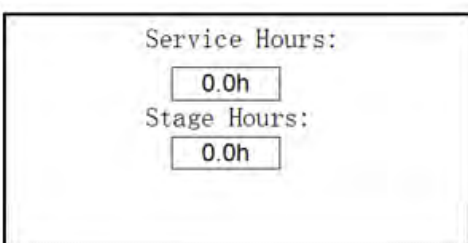

5.6.5.1 Stage Hours Reset

Notice!



Service Hours:	<input type="text" value="0.0h"/>
Stage Hours:	<input type="text" value="0.0h"/>

Figure 9

- On the **Using settings** page (figure 8), press   to select **stage hours reset** query items, press  to enter the **stage hours reset** page (figure 9), and press  to go back to the previous menu.

5.6.5.2 Time and Date Settings

Notice!



Figure 10

- On the **Using settings** page (figure 8), press to select **time and date settings** query items, press to enter the **time and date settings** page (figure 10), and . Press to select time items that needs to be modified (for example, select month “02”). Press to change the value of month and adjust well to complete the modification. Press to go back to the previous menu.

5.6.5.3 Language Settings

Notice!



Figure 11

- On the **Using settings** page (figure 8), press to select **language settings** query items, press to enter the **language settings** page (figure 11), and Press to select the language that a user requires and press to switch to user set language. Press to go back to the previous menu

5.6.5.4 Intensity Settings

Notice!

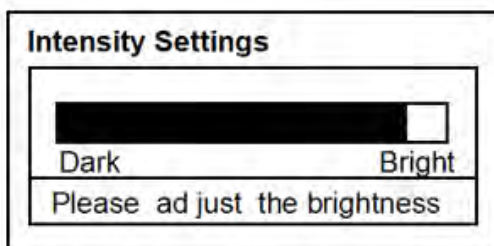

Figure 12

- On the **Using settings** page (figure 8), press to select **intensity settings** query items, press to enter the **intensity settings** page (figure 12), and Press to change the display lightness, which is indicated by progress bar and digits. Press to go back to the previous menu

5.6.5.5 Machine Mode Selection

Notice!

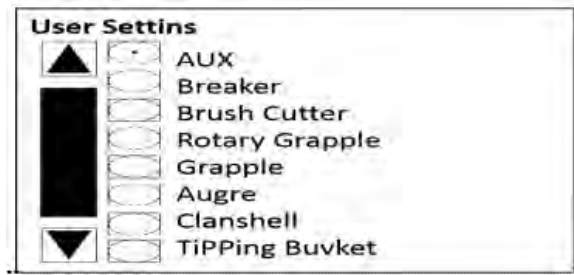







Figure 13

- 1) On the **Using settings** page (figure 8).
- 2) Press  to select **machine model selection** query items.
- 3) Press  to enter the **machine model selection** page (figure 13).
- 4) Press  to select a machine mode.
- 5) Press  to confirm the machine mode.
- 6) Press  to go back to the previous menu.

5.6.5.6 Files Checkout

Notice!

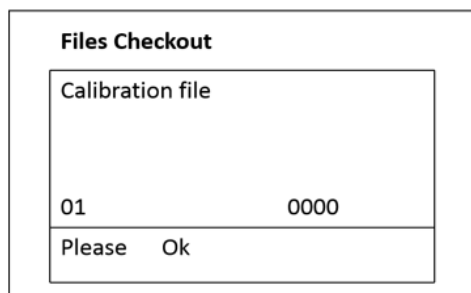

Figure 14

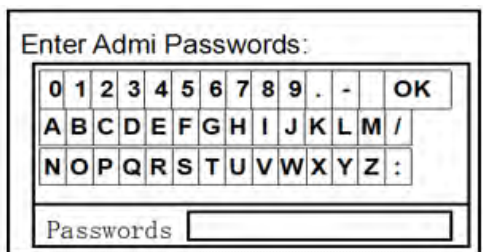









Figure 15

- 1) On the **Using settings** page (figure 8).
- 2) Press  to select **files checkout** query items.
- 3) Press  to enter the **files checkout** page (figure 14).
- 4) Press  to select a machine calibration.
- 5) Press  to confirm the machine calibration by text prompts.
- 6) Press  to go back to the previous menu.

Note:

- Password is required to enter **files checkout**.
- You only need to be authorized of XCMG to get the password.
- On the **enter admi passwords** page (figure 15).
- Press  to select numbers or letters.
- Press  to confirm numbers or letters.
- Press  to confirm the password and then go to **files checkout** page (figure 14).

5.6.6 System Settings

Notice!

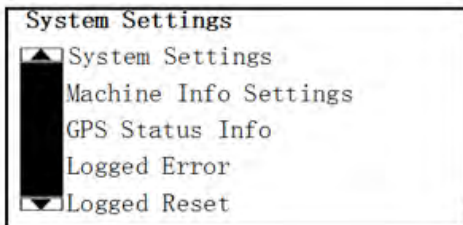





Figure 16

- 1) On the **Main Menu** page (figure 2), press  to select the user query items,
- 2) Press  to enter the **system setting** page (figure 16).
- 3) Press  to go back to the previous menu

5.6.6.1 Parameter Setting

Notice!

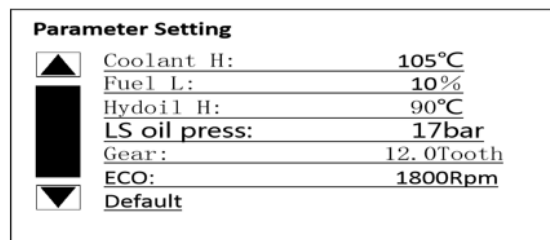

Figure 17

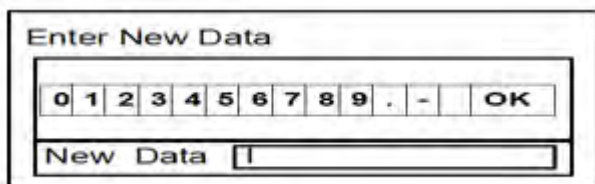















Figure 18

- 1) On the **system settings** page (figure 16).
- 2) Press   to select **parameter setting** query items.
- 3) Press  to enter the **parameter setting** page (figure 17).
- 4) Press   to select a machine mode.
- 5) Press  to confirm the machine mode.
- 6) Press  to go back to the previous menu.

Note:

- Password is required to enter **parameter setting**.
- You only need to be authorized of XCMG to get the password.
- On the **enter adm passwords** page (figure 15).
- Press   to select numbers or letters.
- Press  to confirm numbers or letters.
- Press   to move to “OK” for modify the numbers or letters.
- Press  to go back to the previous menu.

5.6.6.2 Machine Info Settings

Notice!

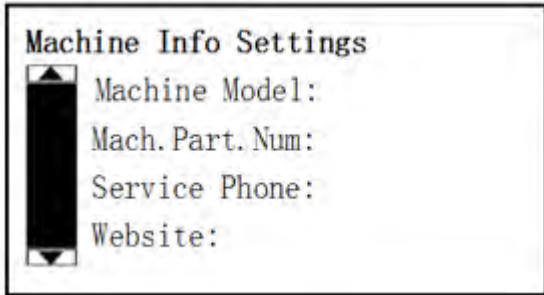





Figure 19

- 1) On the **system settings** page (figure 16).
- 2) Press  to select **machine info setting** query items.
- 3) Press  to enter the **machine info setting** page (figure 19).
- 4) Press  to go back to the previous menu.

5.6.6.3 GPS Status Info

Notice!

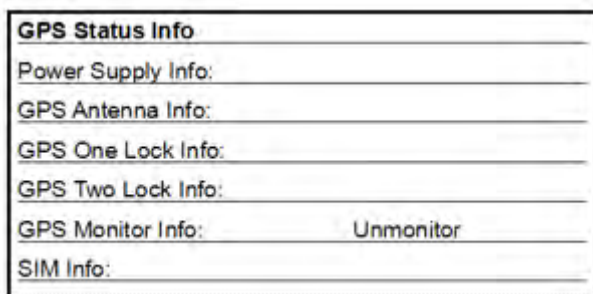





Figure 20

- 1) On the **system settings** page (figure 16).
- 2) Press  to select **GPS status information** query items.
- 3) Press  to enter the **GPS status information** page (figure 20).
- 4) Press  to go back to the previous menu.

5.6.6.4 Logged Error

Notice!

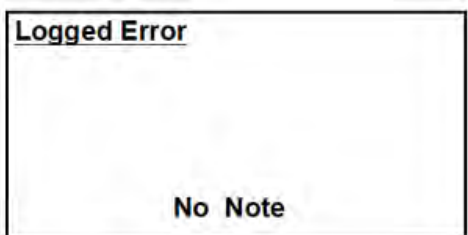





Figure 21

- 1) On the **system settings** page (figure 16).
- 2) Press  to select **GPS status information** query items.
- 3) Press  to enter the **GPS status information** page (figure 20).
- 4) Press  to go back to the previous menu.

5.6.7 Help

Notice!

Help

Hardware model: EXMGXCMG35I V-10

Software S/N: V1.0

Meter number: M16I0602902















- 1) On the **Main Menu** page (figure 2), press  to select the **Help** query items,
- 2) Press  to enter the **Help** page (figure 22).
- 3) Press  to go back to the previous menu



Figure 22

5.7 Precautions measures for operating in risky situations

5.7.1 General risks during operation



 Warning!	<ul style="list-style-type: none">  This excavator has symbols on its control elements that remind the operator what there are for.  When released, most control elements will automatically return to their centered neutral position and stop the executed function or command immediately.
	<ul style="list-style-type: none">  Check your surroundings before slewing and operate the lever carefully.  Do not reach any part of your body out the window while driving or working. If you accidentally hit the boom control lever, or joggle it by any other reason, you may get hurt by the boom.  If the window is missing or broken, replace it as soon as possible.  Avoid injuries caused by accidental movement of the machine.  Be sure to know the position and function of each control element before operation  Avoid boom's crashing the crawler during excavating.  When excavating, you should place the travel motor in the rear, so that the stability of the machine will reach its utmost.

 Danger!	
	<ul style="list-style-type: none">  Do not put your foot on any pedal when the excavator is executing a command → Otherwise, the respective excavator part or equipment may suddenly move.

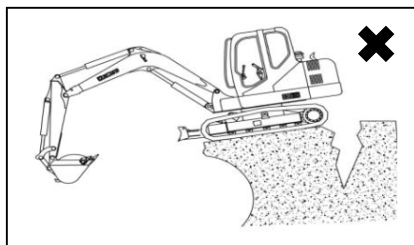
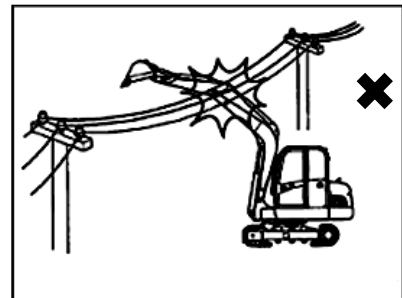
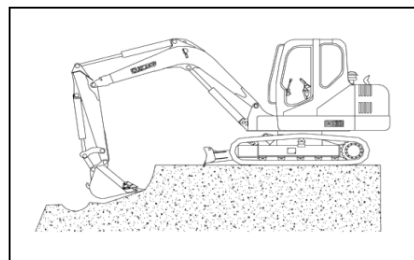
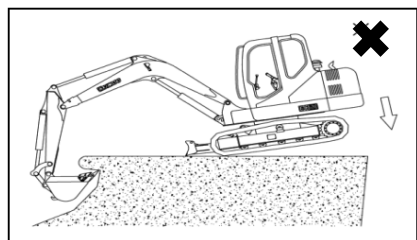
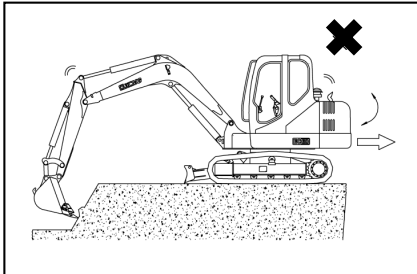
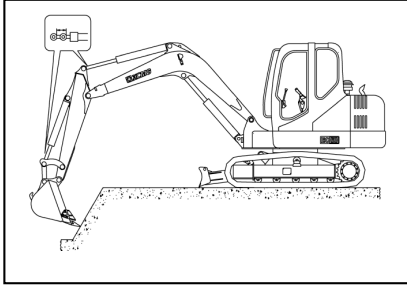
 Warning!	<ul style="list-style-type: none"> – Before start of work, know terrain and soil conditions. when necessary, flat land once!
<div style="display: flex; flex-direction: column; align-items: center;"> <div style="margin-bottom: 20px;">  </div> <div>  </div> </div>	<ul style="list-style-type: none"> – At any time, park your excavator at a flat place as possible. – Before working, check strength of the working surface. – If insufficient, reinforce first. – If you suspect the soil strength, never work on it. Check with supervisor! – If the excavator is likely to be hit by rolling and falling stones or other objects, please contact XCMG dealer and install a window guard net.

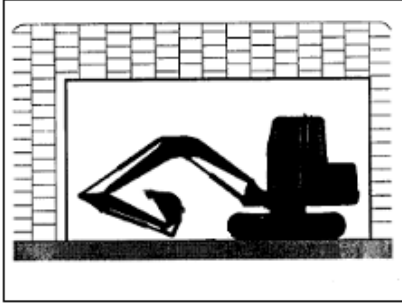
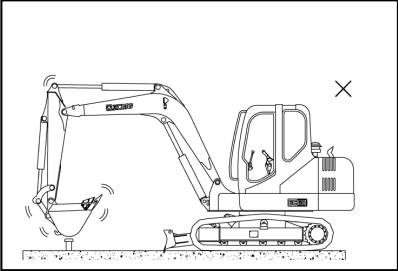
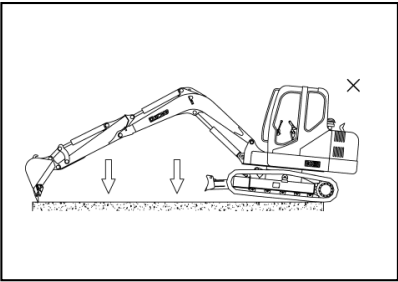
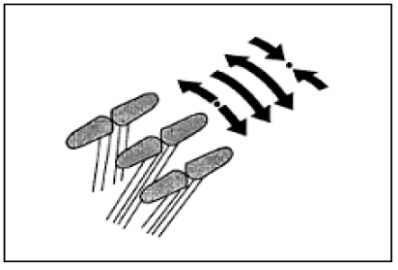

- During digging operations in certain conditions, the boom, arm or bucket may contact upper part or lower part of the machine itself.
- Do not allow a hydraulic cylinder to extend completely in succession, because the fully telescoping cylinder will cause machine damage, for example, when the arm cylinder is completely retracted while the bucket cylinder extends to enable digging operation.
- When the bucket is resisted on ground, do not travel or swing.
- Do not attempt to move stones and crack up walls using swing actions; otherwise, serious machine damage will result.
- Do not move objects by swinging; otherwise, mechanical structures will be damaged.
- Do not use dead weight of the equipment to increase its digging force.
- When working on loose or muddy zones, prevent the machine from sinking.
- Keep enough distance between the machine and the service lines in the air. (see chapter 2.8-2.9 and 2.10)
- Do not dig the area under the excavator.
- When the machine is working at roadside or close to a cliff, make sure that the ground is firm enough. In hard and dangerous terrain conditions, assign a signal man, keep the travel motor at rear of the equipment and the bucket at front, and maintain correct angle between crawlers and roadside.

	<ul style="list-style-type: none"> - When working in tunnels or buildings, ensure enough space at top and well ventilation.
	<ul style="list-style-type: none"> - Do not use the bucket as a hammer or pile driver. - Do not use the bucket to compact when the bucket cylinder extends completely (bucket is completely retracted); otherwise, the bucket and other equipment will be damaged.
	<ul style="list-style-type: none"> - When digging, do not allow crawlers to lift off ground; this will cause damage to mechanical and structural parts
	<ul style="list-style-type: none"> - Do not operate the travel lever rapidly in high-speed travel position. - Avoid sudden start. - Before backing up, you must stop the actions in forward direction completely first. - When you operate the travel lever back and forth, prevent the excavator from receiving shocks. - Avoid sudden braking, - operate softly with care.
	<ul style="list-style-type: none"> - When you operate a lengthened or heavy-duty front device, pay attention to balance among facilities. Observe the operating rules for these attachments.

<p>Danger!</p>	<ul style="list-style-type: none"> - Avoid lifting the equipment while driving downhill a slope. - Do not drive across slopes. - Take extra care when swinging upper structure on a slope. - Make sure enough space is available to stop the swing process. → The swing of a long and heavy equipment will increase slippage of the excavator additionally. - Make sure that all interchangeable equipment has been authorized by the manufacturer and is installed properly.
-----------------------	---

5.7.1 Risks while working underwater

<p>Warning!</p>	<p>Follow the safety advice and rules</p>
------------------------	--

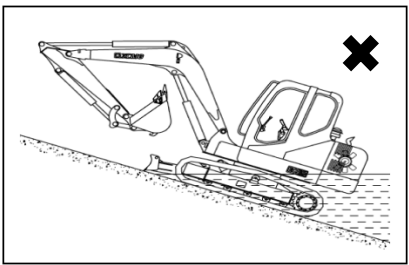
	<ul style="list-style-type: none"> - When working underwater, do not tilt for more than 15° to avoid immerge parts of the engine and damaging the radiator fan or other electric components. - Take extra care if the riverbed is rugged or the stream is fast. - The foundation of the working zone should be hard enough to prevent the machine from sinking. - Do not immerge the machine completely into the water: keep the upper track shoe (that is on the opposite side of your driving direction) out of it as a reference to prevent electric shortcuts and inevitable injuries. - When working on loose and rugged surfaces, the machine may sink. - Always check the position of the machine and observe the crawler's working conditions. - Also, check the riverbed's surface. If needed, readjust the the machine's position. - Prevent water, slurry or sand from entering any of the center swing adapter, the swing bearing or the gearing. - In case that water or slurry has entered the swing bearing or center swing adapter, stop working and move the machine to a firm and dry ground. - Resume work after corresponding observations and necessary maintenance have been finished.
---	---

5.7.2 Risks when working on surfaces with poor bearing capacity

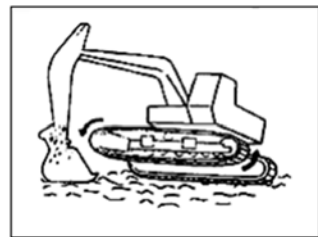
 Warning!	
	<ul style="list-style-type: none"> - Avoid travelling on the surfaces with poor bearing capacity as possible as you can. - Crawlers should have full contact to the ground and not sink into too deeply into the earth, so that the machine can still be towed out. - In case of travel difficulty, lower the bucket to ground, retract the front device, then pull out the machine using hoists. - If slurry, sand or stones enter the crawler and prevent the machine from moving on, do as follows: <ul style="list-style-type: none"> o Lift one of the crawlers off the ground using the front device o Rotate the other crawler forward and backward (see sketch) to remove the foreign materials. - If the machine suddenly stops while on favourable soil, tow the machine using ropes. (Refer to section 5.5.6: "Towing" for more information). <p>NOTE: When jacking up the excavator using the front equipment, prevent the machine from tilting.</p>

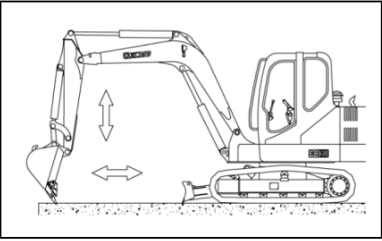
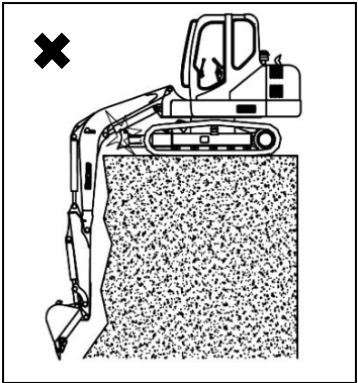

5.7.3 Risks while levelling or operating the dozer

<p> Warning!</p> 	<p>Follow the advices to prevent risks of injury and/or property damage</p> <ul style="list-style-type: none"> – Avoid levelling pavement with the bucket too often, or other parts may be damaged due to overload. – Drive backwards using the dozer to level the pavement. – Use the arm, boom and bucket together. – When leveling the road from front to back, lift up the boom while moving the boom slowly, and then lower the boom smoothly to enable the bucket to move horizontally when the arm is vertical to ground. (see sketch) – Follow the opposite sequence in the previous step to level road from back to front.
	<p>Pay attention to the dozer's positioning</p> <ul style="list-style-type: none"> – When driving forward, avoid hitting the dozer with the boom cylinder or the bucket as often as possible. – When the excavator digs deeply, swing half a turn to move the dozer to the back and ensure safety. – During standard work, the lower end face of the dozer should be placed flat on the ground, to raise the machine's working stability. – Also move the dozer to the machine's back, to avoid hitting it with the equipment. <p>Precaution measures while using dozer</p> <ul style="list-style-type: none"> – The dozer is used only to move earth. Do not use it to cut earth; otherwise, the crawler or dozer will be damaged. – Avoid using the dozer to carry huge weights. Or weights with unstable center of gravity. – The dozer or the crawler's gearing will be damaged. – When traveling, avoid hitching objects with the dozer to prevent damaging it or the crawler machine. – When jacking up the machine using the dozer, ensure that the road surface is smooth and keep the dozer in contact with the ground during the entire process. <p>Take care while retracting the equipment</p> <ul style="list-style-type: none"> – When retracting the equipment, avoid touching the dozer with the bucket (or any other attachment present). <p>Preventing the dozer from touching obstacles</p> <ul style="list-style-type: none"> – Avoid touching obstacles with the dozer to prevent damaging it or the surrounding components. <p>Paying attention to the track shoe</p> <ul style="list-style-type: none"> – During deep digging operations, make sure avoid hitting the track shoe with the boom cylinder.

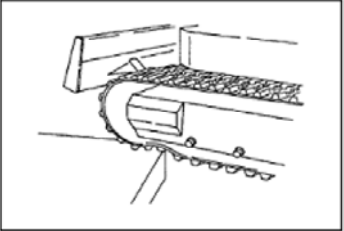
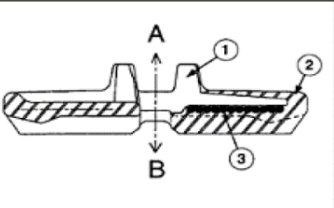
5.7.4 Risks regarding the crawler

 Warning!	<p>Rubber crawlers are not as firm as those made out of steel. Since the former is comparatively soft, take extra care when using the rubber-type on roadsites.</p> <p>To avoid damage caused by the road's surface, follow the advice below when using them:</p>
 	<ul style="list-style-type: none">- When using a rubber crawler, do not travel on graveled soil or sharp stony ground, to prevent damage to the crawler or its inner components (e.g. crawler link band, chain sprocket, etc).- Travelling with a rubber crawler on sandy surfaces may also damage the crawler machine.- Accumulating foreign materials inside the crawler will increase its stress and the risk of damaging it.- Avoid sudden cornering on surfaces having strong friction.- If the crawler is stained with fuel or hydraulic oil, clean it immediately.- Avoid stain by saline substances, as it will corrode the crawler's steel components.- If not in use for a longer period, store the crawler in a shady, cool and dry place.- To avoid damage due to melting, do not operate rubber crawlers on a road with temperature above 60°C.- When a crawler is jacked up, do not use the other one to travel, or it will wear off considerably.- Lower the jacked-up machine with care.- Make sure the crawler does not get loose during travel; otherwise, it may drop and get damaged.- If the rubber crawler or its internal hawser band is scratched, have an XCMG-agent repair it immediately to prevent further damage. <p>Description of a crawler's key parts (see sketch) "A"-Rolling side "B"-Grounding side (1)-Steel plate crawler support (2)-Rubber crawler (3)-Hawser band</p>

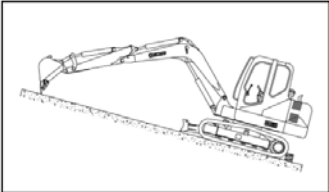
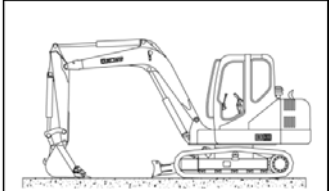
5.7.5 Risks when parking

 Warning!	Follow the advice to prevent risks of injury and/or property damage
  	<ul style="list-style-type: none"> ⚠ Park the machine on a firm and level road surface instead of a slope. If forced to park on a slope, fix the crawlers with seat pads, and insert the bucket into the ground. – Set the engine accelerator rod to “the lowest” idle speed position and idle the engine for about 3 minutes. – If you touch any controls inadvertently, serious accident may result. Shut off the engine and set the safety lever to “locked” position before leaving the cabin

5.7.6 Warning – Towing Operation

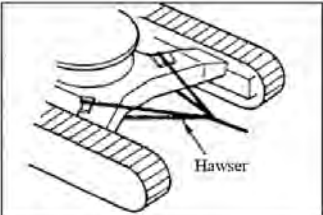
 Warning!	Follow the advice to prevent risks of injury and/or property damage
	<ul style="list-style-type: none"> – Do not use damaged mooring ropes or chains to minimize the risk of accidents. – Wear gloves when handling chains or mooring ropes. – Use ropes or chains strong enough to bear the load. – Tie the chains or mooring ropes on the track frame as shown in the figure. – Do not use the light towing holes at the back of the frame to tow the machine or damage may result. – Insert protective objects (e.g. wood blocks, etc.) between the ropes and the vehicle body to protect them from damage. – When the machine is stuck or the crawlers are trapped in slurry while the machine still works, use a mooring rope to connect the machine to another one to pull it out. – As shown in the figure, connect the drag rope. To avoid the wire rope being damaged, put some protective materials (e.g. wood blocks, etc.) between the travel frame and the wire rope. – Make sure that the wire rope has been connected to the main travel frames on both machines. – Use the other machine to the distressed one to a firm ground.

5.7.7 Risks when operating the hammer



Warning!

- Installing a hydraulic knapper and its line without authorization from XCMG dealer may cause serious malfunctions. This is beyond the warranty coverage of the excavator.

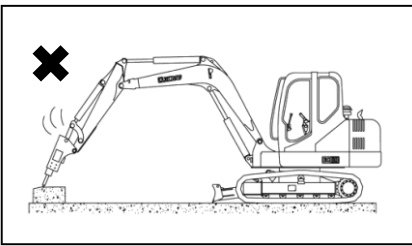

- Selecting hydraulic knapper
 - If you want to install a hydraulic knapper, take the stability of the equipment into account, and ensure that this modification is appropriate. Also, proper pressure and flow should be allowed for. Then, you can contact an agent to select an appropriate hydraulic knapper.

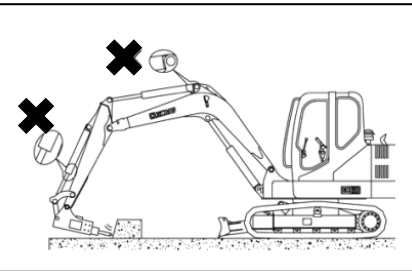

- Hydraulic hoses and steel tubes of the knapper
 - When installing the hydraulic knapper, do the job according to the drawings coming with the unit.
 - If you want to remove the knapper from the excavator, close hoses and hard tubes with plugs and covers to prevent entry of foreign materials into the hydraulic system.
 - Close the knapper joints with covers and plugs to prevent entry of foreign materials.
 - Before start of operation, check all hydraulic joints for leakage or looseness.

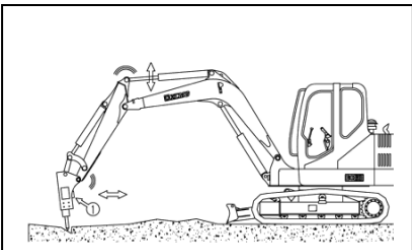

- Hydraulic knapper operations

Notice: Settings of hydraulic oil pressure and flow may require modifications.

- Be sure to read and comprehend the owner's manual of the knapper.
- Check all mechanical and hydraulic connections.
- Do not use the knapper as a hammer. The knapper is comparatively heavy and drops fast, so, do not drop the knapper from a very high place; otherwise, its top structure will be damaged. When operating the knapper, do not extend the boom or arm cylinder completely. A 50 mm or larger clearance should be maintained between the cylinder rod end and the cylinder end so as to prevent the cylinder from damage when you operate the knapper.
- If the cylinder hoses vibrate excessively, do not use the knapper. Check the hydraulic accumulator of the knapper for damage; if needed, repair it. If the excavator works in such conditions, its structure and hydraulic package may be damaged.
- If related equipment is unavailable, working underwater will not be allowed. When the knapper body immerses into water, the knapper seals will be damaged and become rusty so that the external materials or water can enter the hydraulic system to cause failure. Only head of the knapper can be inserted into water.
- Do not use the knapper to lift or haul any object.

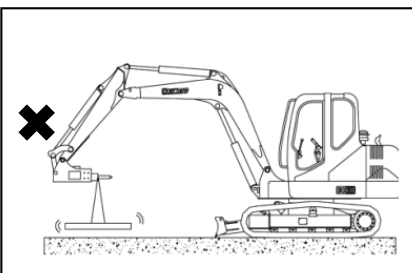
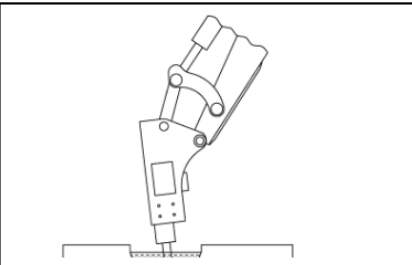

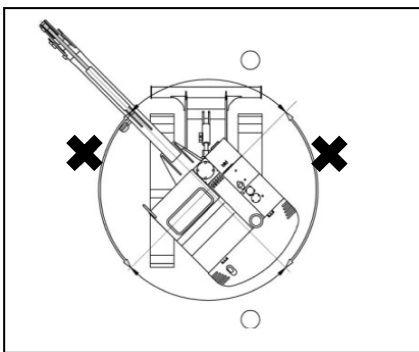

- The knapper can work only when mounted at front or tail of the excavator. Do not mount it at left or right side for the purpose.
- When operating, do not swing back and forth.

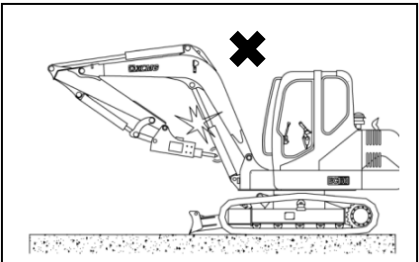

- If the upper structure of the excavator is vertical to the crawler, the knapper operation may cut service life of the machine or result in machine rollover.

- During travel or parking, do not retract the knapper to the bucket cylinder or boom.

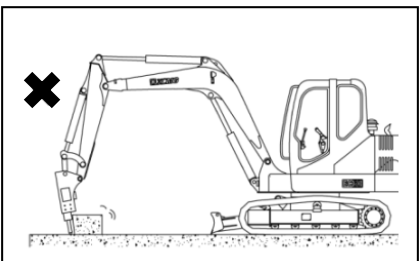

- Do not use the knapper or bucket to move crushed objects, especially, avoid moving using turning power; otherwise, the boom, bucket cylinder and knapper will be damaged.

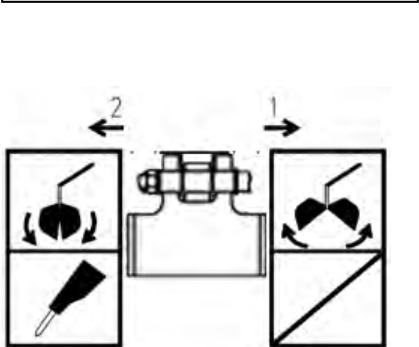

- **Starting knapper**

- o Set the knapper in the section 5.5.
- o Place head of the knapper to required position, press and hold the rocker switch on top of right joystick to left, and then release the swith after the knapper finishes its job.

5.7.8 Warning – Operation in Special Conditions

⚠ Warning!	Operating in Special environmental Conditions
	<p>Operations in extremely cold conditions</p> <ul style="list-style-type: none">– If the excavator works in extremely cold days, protective measures must be taken to ensure normal operation.– The following detailed inspection can ensure normal operation of the excavator at extremely low temperature.<ul style="list-style-type: none">○ Check if correct antifreeze is added in the cooling system at extremely low temperature. Check the cooling system carefully and record status of leakage.○ Keep the battery fully charged to prevent freezing.○ Maintain the engine at optimum so that it is easy to start and operate the engine even at extremely low temperature.○ Select engine oil of proper specification according to temperature. Refer to “Lubrication and Specifications” in engine manual for details.○ Before operation, drain condensate in the fuel tank and water separator, then refill.○ Take out and service the fuel filter element, drain concretions (e.g. wax), and ensure that the solid point of the fuel used is lower than the lowest ambient temperature.○ Lubricate the excavator fully according to “Lubricants and Maintenance Schedule” or the lubrication diagram on the machine.○ Start the engine to warm it up to normal temperature before load-on operation.○ When the excavator is under idle speed, if dirt and ice are frozen on travel motor gears, heat up to thaw the frozen substances before excavator operation attempt.○ Operate the hydraulic units with care until the temperature that normal operation requires is reached.○ Check all machine control units and their functions to ensure normal working.○ In cold days, see the items concerning start in cold days in “Engine Start” in this manual if assisted start is unavoidable.○ To prevent ice coating. Clean up all dirt, snow and water. When possible, cover the machine with canvas and prevent edge of the canvas from being frozen on ground.

Operations in very hot areas

- ⚠ In very hot days, continuous running to the machine will cause overheat. Make sure to monitor the engine temperature and stop the machine to allow it to cool down when needed.
- ⚠ Under high temperature, the dirt inside the cooling system will accumulate faster. Change antifreeze yearly to maintain the resistance to corrosion.
- ⚠ Flush the cooling system regularly to keep its pipes clean. Avoid the use of highly alkaline water; to prevent easier formation of dirt and rust inside the pipes.
- ⚠ Check the electrolyte level daily. In a high-temperature environment, use less concentrated electrolytes. Dilute the electrolyte with specific gravity of 1.280 (unit missing) into that with specific gravity of 1.200~1.240 (missing unit), and then charge it fully.
- ⚠ Recharge the battery whenever reading of specific gravity reaches 1.160 (missing unit). If stored for a longer time under high temperature, the battery will discharge automatically at high rate.
- ⚠ Do not store acid batteries near large numbers of tires as the acid gases will do harm to the rubber.
- ⚠ Lubricate according to “Lubricants and Maintenance Schedule” or the lubrication labels attached on the machine.
- ⚠ When parking for an extended period of time, do it below a shelter to prevent exposure to sunlight, dirt and dust.
- ⚠ If no appropriate covering is available, use a canvas to prevent dust from entering the engine or the hydraulic system.

- ➔ In hot and humid climate, the machine components will corrode faster, especially during the rainy season.

- ➔ Rust and paint bubbles will build up on metal surfaces and spots may appear on other components' surfaces, too.

- ⚠ Apply corrosion resistant lubricant on unpainted or exposed surfaces.
- ⚠ Protect conductors and terminals with insulating mixture.

Apply paint or appropriate antirust materials on damaged surfaces to prevent the rust from spreading.

Operations in dusty or sandy areas

- ⚠ Operation will produce dust in most places. Take extra protective measures when working in dusty or sandy environments.
- ⚠ Wear safety goggles when using compressed air for cleaning.
- ⚠ Clean the machine with compressed air frequently to keep the cooling system and the cooling zone clean.
- ⚠ When servicing the fuel machine, take extra care to prevent dust or sand from entering the oil circuit.
- ⚠ Always keep the air cleaner in good shape. Check its clogging indicator everyday.
- ⚠ Prevent dust and sand from entering engine parts and/or components as well as possible.
- ⚠ Lubricate and service according to “maintenance schedule” or the lubrication diagram attached on the machine.
- ⚠ Before lubrication, clean all the lubrication connections.
 - ➔ Sand mixing in with the lubricant will cause the parts to wear faster. Keep the machine as sand- and dust-free as possible.

Park the excavator under a shelter or cover it with a tarpaulin to prevent potential damage caused by sandstorms.

Working in rainy and humid environment

- ⚠ The notices for working in rainy environments are similar to those described above for working in high-temperature conditions.
- ⚠ Coat all exposed surfaces with lubricant, pay extra attention to damaged or unpainted ones, and apply lubricant to the places where paint cracks occur as soon as possible to prevent corrosion.

Notice**Protection against flying debris or parts**

If the fragments are filled into the eye or bounced to any other part of body, they will cause the severe injuries to body.

- Use the safety goggles or safety glasses to avoid injuries due to flying particles, fragments or debris of any material.
- Prevent others from entering the working place in case of hazard of flying objects.

During the maintenance process:

- Warn the others that any unexpected machine movement may cause severe injuries and hang up the warning plate “No Operation” on the control joystick before maintaining the machine.

Support machine parts in a safe manner:

- Always secure the affected machine parts safely before starting maintenance or repairs on them.
- Always lower the equipment to the ground before maintaining and repairing the machine.
- Do not use slag bricks, cord tires or racks to secure the machine parts that need maintenance or repairs. Those may topple or even break under the parts' steady load.
- Do not work below machine parts secured with a single jack.

Keep away from rotating parts:

- The entrapment of limbs within rotating parts causes severe injuries.
- In case of working next to rotating parts, do not let your limbs, clothes or hair get sucked-in by the rotation.

**Avoid flying parts:**

Warning! The grease within the crawler's tensioning device is under high pressure. In case that you do not observe the following matters, severe injuries, like blindness, or death may be caused:



- Do not remove any of the grease coupler or valve body.
- Keep your body and face far away from valve body since it may fly out suddenly at any time.

**Pressure hazards with the traction reducer:**

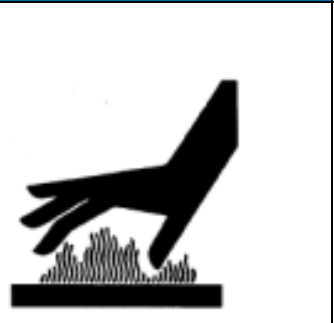

Warning! Keep away from the air bleed bolts, as they may suddenly pop out and cause severe injuries due to sudden acceleration.

- The gear oil is hot. Avoid contact to prevent burns or scalds.
- After cooling the gear oil, loosen the air bleed plug gradually to release the pressure.

Notice**Safe storage of fittings**

	<ul style="list-style-type: none"> ⚠ The machine parts assembled with bearings (e.g.: bucket, knapper, grafter) may suddenly loosen up and fall, causing serious injuries to unaware people nearby. ⚠ To prevent this hazard, always disassemble and store the interchangeable equipment if it is not used for a longer period of time safely to avoid falling, so the children and other personnel should be far away from the storage area.
<p>Notice</p>	<p>Pay attention to hot fluids</p>
 	<ul style="list-style-type: none"> – Avoid burns caused by sprayed high-temperature fluid. After the operation, the engine's cooling water is hot and pressurised. There is hot water or steam inside the engine or the radiator, too. If the skin contacts the spilled hot water or steam, the severe skin burns will be caused. – Prevent burns from hot water. Do not open the cover of radiator before the engine has cooled down. When opening the cover, turn the cover to bottom slowly, and remove the cover after the pressure is completely released. – Pressure exists in the hydraulic oil tank. Ensure that the pressure is released before removing the cover. – High-temperature fluid and surface. During the operation, engine oil, gear oil and hydraulic oil may become hot; engine, hose, pipe and other parts will also become hot. – After the oil and parts cooled, start to check or maintain them.
<p>Notice</p>	<p>Periodic replacement of rubber hose</p>
	<ul style="list-style-type: none"> – Due to ageing, fatigue and wear, the rubber hose containing flammable fluid may be broken under the pressure. It's difficult to judge the poorness of rubber hose due to its ageing and wear and replace the rubber hose at regular intervals. – Irregular replacement of rubber hose may cause the fire, the injection of fluid into skin or the knock of working device to persons around it will cause severe heat injury, dermal gangrene, other injuries or death.
<p>Notice</p>	<p>Pay attention to high-pressure fluid</p>
	<ul style="list-style-type: none"> – If the fuel, hydraulic oil or other fluids injected under high pressure can penetrate the skin or rip into the eyes, it will cause severe injury, blindness or death. <ul style="list-style-type: none"> ○ Release the pressure before removing the hydraulic or other pipes to avoid this risk. ○ Fasten all connections before repressurizing. ○ Use cardboard to find leaks, and protect your hands and body from high-pressure liquids. Wear the face mask or safety goggles to protect your eyes. ○ In case of any accident, let the doctor who's familiar with this type of wound cure immediately. – Any fluid injected into skin must be removed through surgery within several hours, otherwise the dermal gangrene will be caused.

<p>Notice</p>	<p>Treatment of accumulator</p>
----------------------	--

	<ul style="list-style-type: none"> - The pilot control system is equipped with an accumulator filled with high-pressure nitrogen, so the pressure of machine must be relieved during the maintenance of pilot control system. It's very dangerous in case of incorrect operation. <ul style="list-style-type: none"> o Do not drill on the accumulator, or do not make it contact the flame, fire or heat source. o Do not weld the accumulator, or do not attach any article on it. o In case of removing, maintaining or treating the accumulator, the filled gas must be discharged. Contact with our company or supplier. o In case of treating the accumulator, wear the safety goggles and protective gloves. The high-pressure hydraulic oil will stab the skin and cause the injury.
Notice	Safety maintaining air-conditioning system
	<ul style="list-style-type: none"> - The splash of refrigerant on skin will cause the frost injury. <ul style="list-style-type: none"> o During the maintenance of air-conditioning system, use Freon correctly as per the instructions for Freon container. o Adopt the recovery or recirculation machine to prevent Freon from discharging into the atmosphere. o Do not make Freon fluid contact the skin.
Notice	Correct treatment of discards
	<ul style="list-style-type: none"> - Any improper treatment of discards will harm the environment and ecology, and the potential harmful discards include hydraulic oil, fuel, engine oil, coolant, filter and battery, etc. <ul style="list-style-type: none"> o In case of discharging the fluid, use the leak-proof container. Do not use the food or drink vessel, because it may cause the wrong drinking. o Do not pour the waste liquid on the ground, into sewerage or any water source. o The air-conditioning refrigerant is leaked into the air, which will damage the atmospheric layer of the earth. According to the government regulations, an air-conditioning service center with desired certificates may be required to recover and regenerate the air-conditioning refrigerant. o Inquire the correct recovering or treatment methods of discards from local environmental protection or recovery center or your assigned dealer.

6.2 Inspection Checks before Starting

Warning!

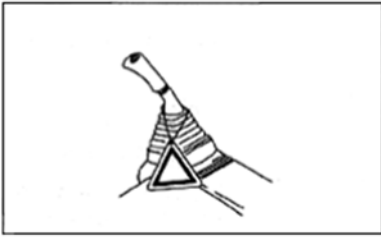

- **Warning labels**
- **“No Operation” warning label must be hung on the working (arm, bucket and boom) joysticks in the cab to warn that someone is maintaining the excavator.**
- When the warning sign is not in use, put it in the tool box.
- During maintenance, if someone starts the engine, touches or operates the working (arm, bucket and boom) joysticks, it may cause serious personal injury or damage to the machine.

Notice!

Keeping the work area clean and tidy

- Do not scatter the hammer or other tools in the work area. Wipe off all slippery grease, oil or other substances. Keep the work area clean and tidy, so as to secure the working process. If the work area is not kept clean and tidy, persons may stumble, slip or drop, and cause injury.
- Top window which is made by organic glass (polycarbonate) should be cleaned with water, and not with any alkaline solvent. If benzene, toluene, methanol or other basic solvent are used, chemical reaction will be caused, like that glass is dissolved or decomposed, and polycarbonate will age.

The location of the safety labels on the machine

There are several special safety labels on the machine, here indicates their exact locations and the harms of accidents.

- Please get familiar with all these safety labels.
- Ensure that you can see all the safety labels clearly.
- If the words of a safety label are unclear, clean the label or replace it.
- If the illustrations of a safety label are unclear, replace them. Clean the safety labels with cloth, water and soap. It's prohibited to clean the safety labels with solvents, gasoline or caustic chemical agents, they can make the labels loose, cause them to fall off.
- If any safety label is damaged or lost, it must be replaced immediately. If the part to be replaced has a safety label, ensure that the part to be replaced with also has the safety label.



When working with others, one conductor should be appointed.

- When repairing the machine or when disassembling or installing working devices, a conductor should be appointed and follow his command during the operation.
- When working together, persons that not familiar will cause serious accidents.

Notice!



Shut off the engine before maintenance

- The machine should be stopped on solid and flat ground.
- The place with unfallen stones, collapses or is of no danger of being submerged should be chosen.
- Lower the working device completely to the ground and shut off the engine
- Put stopper blocks under the crawler tracks in order to prevent the excavator moving.

Notice!

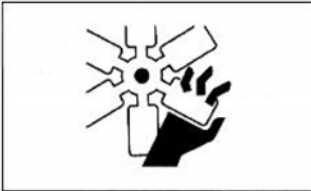

When the engine is running, two persons carry out the maintenance

- To prevent injury, do not carry out the maintenance when the engine is running. If the maintenance must be carried out when the engine is running, operate it with at least two people, and follow the rules below:
- One people must sit in the operator's seat and be ready to shut off the engine. All people must keep in communication with each other.
- Pull(or push) the safety lever to the locked position.
- When operating near the fan, the fan belt or other rotating parts, the operator must pay special attention to prevent being coiled.
- Prohibit touching any operating lever. If necessary, the operator needs to send signals to other people to warn them to move to a safe place.
- It is forbidden to drop or insert tools or other objects into the fan or fan belt, otherwise the parts may break or fly out.

Notice!

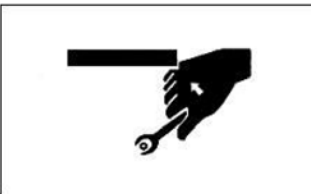

Suitable tools

- Proper use of suitable tools, such as the use of damaged, inferior, defective, temporary tools or unsuitable tools may cause serious personal injury.



Energy container (accumulator)

- **The energy container is filled with high pressure nitrogen.**
- When operating the energy container, the careless operation will cause explosion, and cause serious injury or damage. Therefore, the following matters must be observed:
 - o Do not decompose the energy container.
 - o Do not approach the energy container to the fire.
 - o Do not punch and weld on the energy container, or use the welding torch on the energy container.
 - o Do not collide or roll the energy container, and do not make the energy container suffer any impact.
 - o When disposing of the energy container, gas must be discharged. Please contact with XCMG dealer to deal with this task.

Personnel

- Only trained personnel is allowed to maintain or to repair the excavator, Untrained personnel is not allowed to enter this area. If necessary, an observer can be arranged

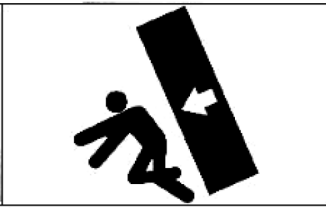

Accessories

- Before removing or installing the accessories, a conductor will be appointed.
- The accessories which are removed from the excavator should be put in a stable place where the accessories do not fall. Measures should be taken to prevent unauthorized persons from entering storage area.



Working under the excavator

- If you need to carry out maintenance under the machine or working equipment, firmly support the working equipment and machine with pads and brackets strong enough to support the weight of the working equipment and machine.
- If the crawler tracks leaves the ground, the machine is only supported by the working equipment; if the control levers or hydraulic pipes are accidentally touched, the equipment or the machine may suddenly fall. If the pads or the frames are not used to support the machines, working under the machine is prohibited.



Noise

- If the noise of the machine is too loud, temporary or permanent hearing problems can be caused.
- When persons maintain the engine and suffer the noise for a long time, ear covers or earplugs should be worn.

Notice!

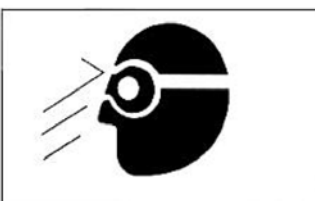

Using the hammer

- When using the hammer, pins may fly out, metal particles may scatter, the serious damage can be caused, and then, the following steps need to be followed:
 - If the hammer is used to strike hard metal parts, such as pins, bucket teeth, blade or bearings, fragments may scatter and cause harm, and therefore, goggles and gloves should be worn during operating.
 - When striking the pins or the bucket teeth, the fragments may fly out, ensure there are no people around to avoid personnel injury.
 - If struck strongly, the pins may fly out and cause injury to surrounding people.

Welding operation

- Only the proper device can be used, and the operation shall be performed by qualified welders.

Removing the battery terminals

- When repairing electrical systems or welding, the terminals of the battery negative electrode (-) will be dismantled, which prevents the current from flowing.



Checking the machine

- To avoid injury, carry out a patrol inspection around the machine before starting it per day or per shift.
- When inspecting around the machine, you must inspect according to the chapter “inspection before starting” of this operation and maintenance manual.

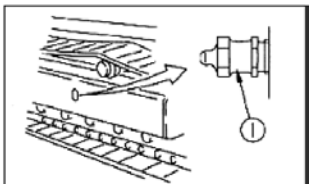

When the crawler tracks tension is adjusted with high-pressure grease, the safety need to be paid attention to.

- The grease is pressed into the crawler tracks tension adjustment system under high pressure. When adjusting, if the maintenance procedure is not observed, the grease emission plug ① will fly out, which will cause serious injury or damage.
- In order to relax the crawler tracks tension, the grease emission plug ① is loosened, the emission plug which is loosened is not turned over one lap, and simultaneously, the grease emission plug must be loosened slowly.
- Do not bring the face, hands, feet or other parts of the body close to the grease emission plug ①.



Do not remove the buffer spring

- The buffer spring assembly is used to alleviate the impact force of tension pulley, the buffer spring includes a high-tension spring, if the high-tension spring is removed in a wrong way, the spring will fly out, which causes serious injury or death.

Notice!



Relevant safety rules of high-pressure oil

The internal part of the hydraulic system always has pressure; when checking or replacing pipes or hoses, the pressure in the hydraulic oil pipe must be checked whether it has been released or not. If oil pipe still has the pressure, serious injury or damage can be caused, so the following rules need to be obeyed:

- When the hydraulic system has the pressure, before releasing the pressure, do not carry out check or replace.
- If the surrounding area of the pipes or the hoses is wet, the pipes or the hoses should be checked for break, and the hoses for inflation.
- When checking, goggles and leather gloves should be worn.
- The high-pressure oil which leaks from small orifices can penetrate skin and may cause blindness if contact eyes directly. If skin or eyes contacted with the high-pressure oil were injured, skin or eyes should be flushed by clean water and go to hospital for treatment immediately.

Safe Operation of High-pressure Hose

- If the hose leaks, it may cause fire or faulty operation, resulting in serious injury or damage.
 - If the bolt looseness is found, stop operations and fasten the bolts to the specified tightening torque. If there is any damage to the hose, stop the operation immediately, and contact with the dealer of XCMG.
- If there is any of the following problems, replace the hose:
 - Damage or leakage of hydraulic pipe connection.
 - Cladding frayed or disconnected, and or strengthening layer wire exposed.
 - Cladding expands in some places.
 - Movable parts distorted or crushed.
 - Impurities inside cladding.



Waste

To prevent pollution, attention should be paid to the treatment of waste:

- Discharge the oil from the machine into the container; do not discharge it directly to the ground, or into the sewers, rivers, oceans or lakes. When dealing with hazardous materials, such as engine oil, fuel oil, cooling fluid, solvents, filter and batteries, it is necessary to comply with the laws and regulations.
- According to the requirements of laws and regulations, the whole machine, parts and accessories that need to be disposed of must be properly handled in accordance with laws and regulations.

Air Conditioner Maintenance

- If the air conditioner refrigerant gets into the eyes, it may cause blindness; if the refrigerant comes into contact with skin, it can cause frostbite.

Compressed air

- When cleaning with compressed air, it may be caused by flying particles causing personal injury or machine damage.
- When using compressed air to clean the filter element or radiator, wear goggles, dust masks, gloves and other protective equipment.

Notice!

Periodic Replacement of Safety-critical Parts

- For long-term safety of in operation of the machine, there is need for regular lubrication and maintenance. To further enhance security, the safety-related parts such as hoses, seat belts should be periodically replaced.
- When exceeds the allotted time, the material of parts will naturally change. Reuse will cause deterioration, wear and damage. Finally, these parts may break down and cause serious injury or damage. During the operation, it is difficult to judge how long these parts can keep working according to an external inspection or touch, so replace it regularly
- If there are any defects in safety-critical parts, replace or repair it even it has not reached the allotted time.

6.3 Installation for the accessories and other safety instructions

Notice!

Installation for the accessories and other safety instructions

- When installing the optional parts or accessories, please contact the **XCMG** distributor in advance. Any injury, accident or product fault caused by using the accessories or parts without approval from **XCMG**. will be unrelated with this company.
- When installing and using the accessories, combine the operating accessories according to the operation and maintenance manual about the accessories and the general instruction about the accessories in this manual.
- Due to the different types or combinations for the equipment, there is the risk that the equipment collides with the driver' cab or other parts of the machine. Before using the unfamiliar equipment, check whether there is the risk to influence each other and operate it carefully.



TOPS, FORS/ROPS

- The different types of guards are used to protect the operator.
- The machine and the machine application determine the type of guard that should be used.
- The ROPS/FOPS Structure (if equipped) on your machine is specifically designed, tested and certified for that machine (in accordance with the standard ISO 10262:1998, ISO 12117-2:2008).
- TOPS (Tip-Over Protection Structure) is another type of guard that is used on compact excavators(in accordance with the standard ISO 12117:1997)
- A danger will occur when some falling stones or flying objects crash onto the cab on the construction site.
- Please choose the protection device which is suitable for the operation condition to protect the driver.
- When working on a mine, tunnel, dell or mellow and humid surfaces, you may be in the danger caused by falling stones or flying objects. So it is very necessary to install protection devices on the cab which shall meet the requirements on FOPS (Falling Object Protective Structure) or window protection devices.
- It is forbidden to reform or change the protection structures of any type by strengthening devices, such as drilling, welding, or resetting the fasteners. All of the protection system which suffers severe impact or damage shall be reappraised. If necessary, re-install, re-certify or replace the system.
- Purchase necessary optional devices without any statement. The machine of standard cab is not equipped with ROPS/FOPS. If it is necessary, please explain the situation to the agent or contact **XCMG**. and use the device according to the right installation and application range.
- The cab which is equipped with FOPS/ROPS devices cannot be dismantled at will, and the cab without protection devices will lose its protection function. If any plastic deformation or breakage appears in any part of the protection structure (e.g., it is affected by rolling, falling object or dumping), please contact the agent and let the authorized professionals replace the protection structure.



Brief description on replacing FOPS/ROPS:

- Check whether the soleplate of the protection device is rusted or damaged. If any, please contact the distributor appointed by **XCMG** and let the authorized professionals to do the repair.
- Equip appropriate hoisting tools to take down the original protection device carefully and save it safe or hand it over to some specially assigned person.
- Install the new undamaged protection device carefully and tighten up the fasteners with necessary tools.
- Never operate the excavator without the protective structure.

Modification without approval

- Any modification without approval from Xuzhou XCMG Excavator Mechanical Co., Ltd. is possible to cause danger. Therefore, before modifying, please contact the distributor of **XCMG**.
- For any injury, accident or product fault caused by modification without approval from **XCMG**, the company will not bear any responsibility.

Notice!

Removal of counterweights and front-end equipment

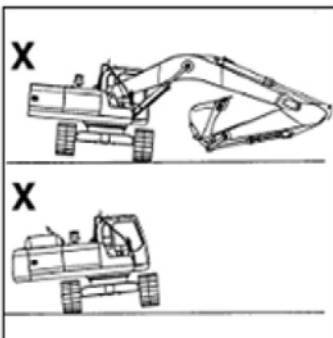

- Warning: Removal of counterweights or front-end equipment or any other component from the machine will affect its stability and this will result in its sudden move causing serious injury and death.
- You can remove counterweights or front-end equipment only when the top structure and the bottom structure are disposed of in the same direction. Once counterweights or front-end equipment is removed, do not rotate the top structure

Safety in the workplace

- Before operating, check the work area thoroughly for dangers.
- When operating near the flammable materials (cottage roof, dry leaves or grasses) stored, it is possible to cause a fire, so it is necessary to be careful during operating.
- Check the ground situation in the workplace and finalize the safest operation method. It is forbidden to operate in the place with collapses or falling stones.
- If there are water pipes, gas pipes or high voltage electrical wires buried under the workplace, please contact the related companies and mark their positions, note: do not break or damage any pipe and wire.
- It is forbidden for any unauthorized person to enter the working area, some necessary warning measures should be taken.
- Before moving or operating in the shallow water or on the soft ground, check the types and situation of the sill and the depth and the flow rate of the water.

6.4 Lubrication and Repair



Warning!

- Only those trained and qualified can repair and maintain this machine.
- Before any maintenance, read carefully the related content in this book.
- If diesel engines are running indoors, ensure good ventilation condition.
- For the details of diesel engine, see **OPERATION MANUAL OF DIESEL ENGINE**, which is included in the documents along with the excavator.
- While carrying out maintenance or repair for this machine, the related record should be made and saved.
- For the excavator, it is important to maintain and ensure its normal function. So the machine should be kept clean so that any failure such as leakage, looseness of screw or connection will be spotted.
- Pay attention to environmental protection! Don't let oil and other harmful things to pollute our environment. The waste liquor should be disposed of according to the local laws and regulations and it is not permitted to discharge waste liquor casually.
- The content of this chapter includes items related to regular check, maintenance and repair.
- The operator of excavator should carry out according to the regulations.

Notice!

- **Correct procedures of maintenance and check**
- In order to maintain and repair the machine correctly, follow the correct maintenance and check procedures described in this manual.
- a) Check the machine before starting it every day.
 - 1) Check the controller and instruments.
 - 2) Check the levels of coolant, fuel and hydraulic oil.
 - 3) Check the hoses and pipes for leaks, twists, wears or damages.
 - 4) Make a patrol inspection of common conditions, noises or heat around the machine.
 - 5) Check the part for looseness or missing.
 - 6) If anything is wrong with the machine, repair it before the operation, or contact with your assigned dealer.
- **Important:**
 - 1) Adopt the correct oil products, grease and anti-freeze fluid.
 - 2) Any use of incorrect oil in the grease or sterling part will lead to the loss of product warranty.
 - 3) Don't adjust the engine speed limiter or hydraulic system safety valve.
 - 4) Avoid any contact of electric component with water and steam.
 - 5) Don't disassemble the main controller, sensor or other electric components.
- b) **Check the hour meter frequently:**
 - 1) Determine the time of machine check and maintenance according to the operating hours shown by the engine working hour meter.
 - 2) The intervals shown in List of Maintenance Periods are determined as per the normal operation and maintain the machine in shorter interval in case of running the machine under the bad conditions.
 - 3) Make a periodic check and adjustment of lubrication or maintenance as per the readings of periodic maintenance meter on the inner side of tool-box cover.
 - 4) When the hours of hourmeter reach the replacement time of recommended lubricant and filter element, or during the periodic check every day or every month, replace the lubricant and filter element.
- c) Adopt the correct oil products, lubricant and anti-freeze fluid.
- Important: adopt the correct oil products, grease and anti-freeze fluid always, otherwise the machine will be damaged, and the warranty of this machine will be lost.

6.5 Maintenance Schedules

6.5.1 Lubrication Period

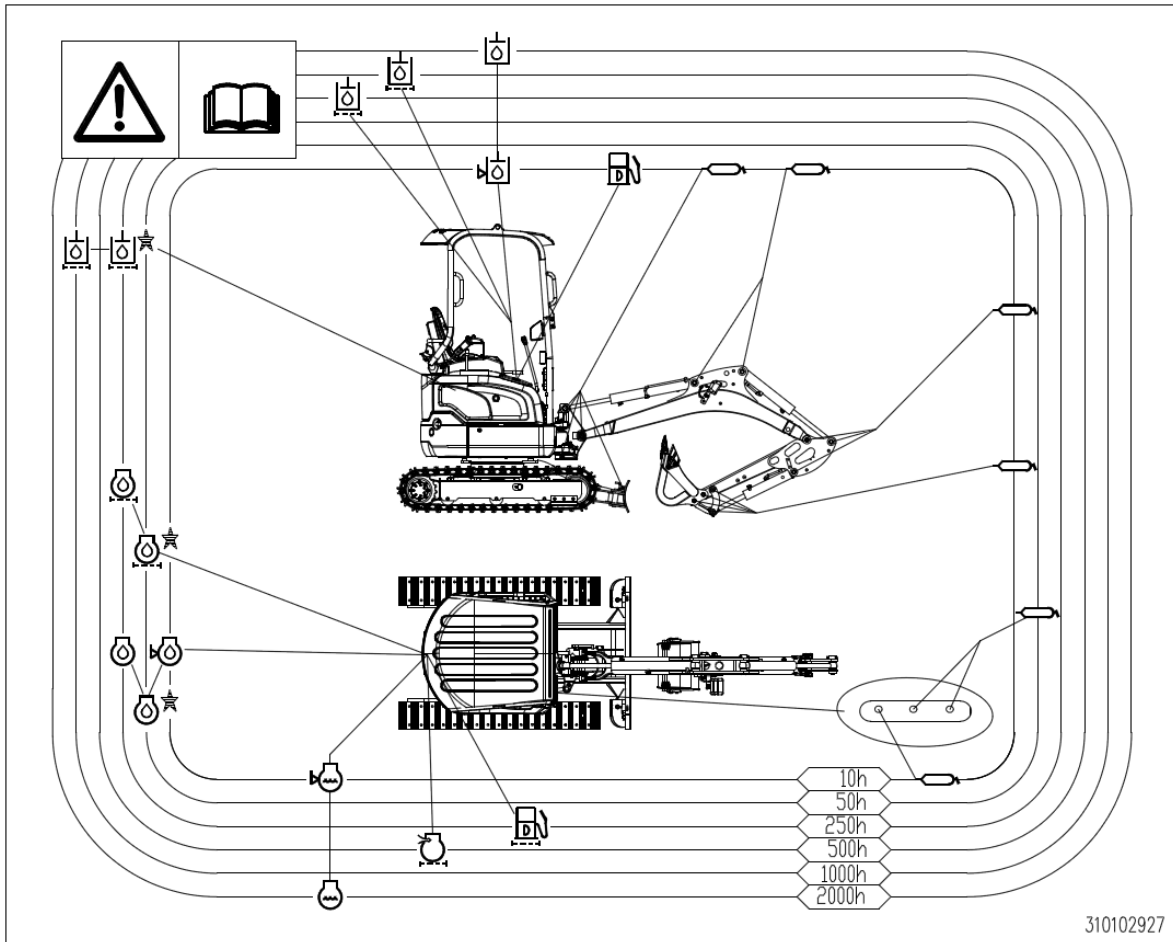

Symblo	Description
	Lubrication
	Gear oil (Swing device, Travel device)
	Engine oil
	Engine oil filter
	Hydraulic oil

Symblo	Description
	Coolant
	Air cleaner element
	Fuel filter
	Gear oil (Axle)
	Hydraulic oil filter

SERVICE DATA										
No.	Items to check		Service	Qty.	Service interval					
					8	50	100	250	500	1000
1	Work device	Bucket and link pin	Grease	9	▲					
2		Others	Grease	11	▲					
3	Swing bearing		Grease	2		▲				
4	Swing reducer gear		Grease			▲				
5	Swing device oil-bath		Grease	-		▲				
8	Hydraulic oil suction strainer		Strainer	1					●	
9	Hydraulic oil		Hydraulic oil	28L	C/▲					●
10	Hydraulic oil return filter		Element	1			○	●		
11	Pilot filter		Element	1			○		●	
12	Breathing valve filter		Element	1				●		
13	Water separator		Element	1	C		●			
15	Fuel filter		Cartridge	1		○	●			
16	Engine oil		Engine oil	3.8L	C/▲	○	●			
17	Engine oil filter		Cartridge	1		○	●			
18	Radiator		Coolant	4L	C/▲					●
19	Air cleaner (outer)		Element	1			△		●	
	Air cleaner (inner)		Element	1					●	
21	Fuel tank		Diesel	17L	C/▲			△		
22	Crawler tension device		Grease	2		▲				
25	Alternator		Check	-	Please contact your XCMG dealer.					C
26	Starter motor		Check	-	Please contact your XCMG dealer.					C
27	Fuel injection pump		Check	-	Please contact your XCMG dealer.					C
28	Coolant hose		Change	-	Replaced every 2 years. Please contact your XCMG dealer.					
29	Coolant hose clamps		Change	-						
30	Fuel lines		Change	-	Replaced every 2 years. Please contact your XCMG dealer.					
31	Air intake hoses		Change	-						
32	Safety belt		Change	-	Replaced every 3 years. Please contact your XCMG dealer.					
33	Hydraulic hoses		Change	-	Replaced every 6 years. Please contact your XCMG dealer.					
34	Dozer blade pin		Grease	4	▲					
C	Check.									
△	Cleaning.									
▲	Maintenance and refill or add.									
○	First time exchange only.									

●	Replacement on every interval.
F	Every 8 hours for first 100hours.
W	Every 8 hours if operating in water.
	<p>Note:</p> <p>When using a breaker over 20%, replace hydraulic oil every 1600h. When using a breaker over 40%, replace hydraulic oil every 800h. When using a breaker over 60%, replace hydraulic oil every 600h. When using a breaker over 80%, replace hydraulic oil every 400h.</p>

Safety points for attention and precautionary measures

 Caution!	<p>– Safety points for attention</p> <ul style="list-style-type: none"> – Summarize the working hours correctly to determine the lubrication time. – Stop in case of filling the grease, and don't apply any lubrication work if not parked as per the requirements of this manual. – Adopt the fire-prevention measures during the lubrication. – Prevent hot oil and harmful substances from harming the operators. – Avoid mixing the lubricating oils of different brands. – Clean the lubricated parts and vent hole, etc before filling; keep the tightness of seal ring after filling. – Clean or replace the filter at regular intervals, make a mark after draining the engine oil, and don't start the filter without oil. – Remove the spilled lubricant. – Refilling of slewing bearing gear face, rotate one time about every 90 degrees, refilling for four times and each point for 50g grease.
---	--

6.5.2 Operator Maintenance checklist

Check items		Service	Maintenance intervals
Walk-around inspection		check	Daily
Hydraulic oil level		check,add	Daily
Control panel and pilot lamp		check,add	Daily
Hydraulic hoses and pipes	Leak or crack	check,clean,tighten	Daily
	Crack or bend,etc	Check,repalce	250h
Fuel level		check,refill	Daily
Engine oil level		check,add	Daily
Water separator		check,clean	Daily
Fuel tank		drain	Daily
Fuel hoses and air intake hoses	Leak or crack	check,clean,tighten	Daily
	Crack or bend,etc	Check,repalce	250h
Coolant level		check.add	Daily
Coolant radiator and oil cooler core or intercooler		check.clean	200h
Front mesh enclosure of oil cooler		check,add	500h
The air conditioner condenser		check,clean	500h
Fan belt tension and damage		check,adjust	Daily
Bucket teeth for wears and loosening		check,replace	Daily
Bucket connection(bolt.etc)		check,adjust	Daily
Seat belt for proper operation		check,replace	Daily
Air cleaner(outer,inter)		check,clean	250h
Cylinder head bolt		check,tighten	Daily
Electrical equipment		check	Daily
Battery		check	50h
Lubricate the front-end attachments	Boom,arm and front attachment pins	Check,grease	Daily
	Swing bearing	grease	50h
	Swing reducer gear and device oil-bath	Check,grease	50h
Crawler tension		Check,setting	50h

- If there is a lot of dust,the air filters and the fresh air filters must be cleaned and/or replaced more often.

6.6 Lubrication of equipment

 Warning!	<ul style="list-style-type: none"> – High-quality lubricant should be added according to appointed quantity. – Excessive lubricant or grease may lead to overheating and even speed up the abrasion.
---	--

6.6.1 New machine

New machine used and filled with following lubricants.

Item	Specification
Engine oil (API CJ-4, ACEA-E9)	SAE 10W-40
Hydraulic oil	ISO VG 46
Fuel	ASTM D975 No.2
Grease	NLGI No.2
Coolant	Add antifreeze (50% antifreeze-50% distilled water)
Gear oil	SAE 80W-90

SAE: Society of Automotive Engineers
API: American Petroleum Institute
ISO: International Organization for Standardization
NLGI: National Lubricating Grease Institute
ASTM: American Society of Testing and Material

 Warning!	<ul style="list-style-type: none"> – If the excavator works in specially high or cold condition, special lubricant should be used. You are suggested to contact with excavator dealer appointed by XCMG. – If the above requirements can't be satisfied, please contact with XCMG excavator agent or its after-market department.
---	---

6.6.2 Recommended oils

Use listed below or equivalent only. Do not mix different brand oil.

Service point	Kind of fluid	Capacity /(imperial gal)	Ambient temperature °C / °F								
			-50	-30	-20	-10	0	10	20	30	40
			-58	-22	-4	14	32	50	68	86	104
Engine oil pan	* Engine oil	3.8(0.86)	SAE 10W-30								
			SAE 10W-40								
			SAE 15W-40								
Hydraulic oil tank	*** Hydraulic oil	Tank: 18(4.1) System: 10(2.3)	ISO VG 32								
			ISO VG 46								
			ISO VG 68								
Fuel tank	**** Diesel fuel	17(3.9)	ASTM D975 No.2								
			ASTM D975 No.1								
Grease fitting	Grease	As required	NLGI No.1								
			NLGI No.2								
Cooling system	Coolant	4(0.91)	Add antifreeze (50% antifreeze-50% distilled water)								

* Engine oil must meet ACEA-E5 or API-CI-4
*** Hydraulic oil change interval is 2,000hours, only when XCMG Genuine Oil is used. If other brand of oil is used, guaranteed change interval is 1,000 hours.
**** Diesel fuel must be ultra low sulphur diesel. Sulfur content ≤ 15 ppm.
SAE: Society of Automotive Engineers
API: American Petroleum Institute
ISO: International Organization for Standardization
NLGI: National Lubricating Grease Institute
ASTM: American Society of Testing and Material

 Warning!	<ul style="list-style-type: none"> – High-quality lubricant should be added according to appointed quantity. – Excessive lubricant or grease may lead to overheating and even speed up the abrasion.
---	--

 Caution!	<ol style="list-style-type: none"> 1. Do not mix oil from different manufacturers. XCMG does not endorse specific brands but does suggest that owners select quality oils whose suppliers provide assurance that required standards will always be met or exceeded.. 2. Fluctuating daily or weekly extremes of temperature, or operation in subzero freezing weather may make it impractical to use straight weight lubricants. Use good judgement in selecting lubricant types that are appropriate for climate conditions.
---	---

6.6.4 Lubrication Points

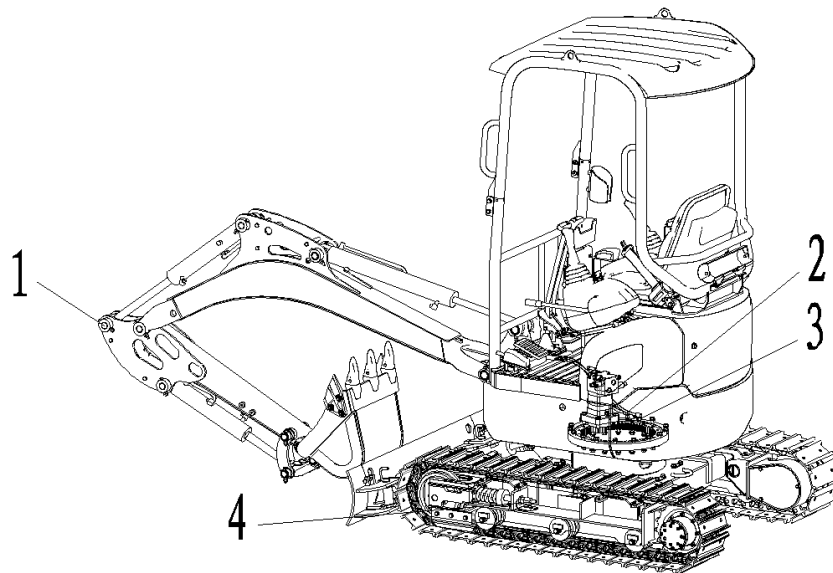

Serial number	Position		Quantity
1	Connection points of equipment	Bucket, arm and pin of connection rod	14
2	Swing bearing		1
	Rotation device oil-bath		1
3	Tension device		2

6.6.5 Connection points of equipment

Notice!

–



6.6.5.1 Bucket, arm and pin of connection rod

–



6.6.5.2 Pin at the root of boom

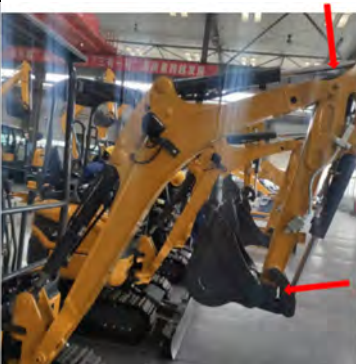

6.6.5.3 Connection pin between boom and arm, hydraulic cylinder piston and bottom pins of arm

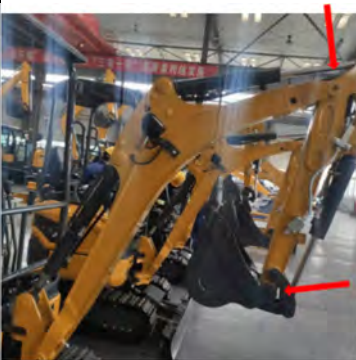

6.6.5.4 Bottom of boom cylinder



6.6.5.5 Pin of boom cylinder and bottom pin of arm cylinder



6.6.5.6 Rotary bearing



6.6.5.7 Rotation device oil-bath

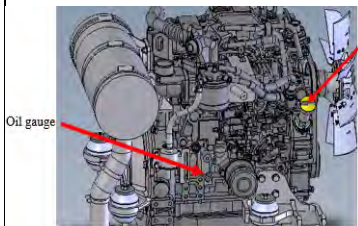

6.6.5.8 Engine

6.7 Maintenance of Hydraulic System

Caution!

During the operation, the parts of hydraulic system will become very hot, and cool the machine before check or maintenance.

- During the maintenance of hydraulic device, ensure that the machine shall be placed on the flat or hard ground.
 - b) Lower the bucket to the ground and shut the engine off correctly.
 - c) Maintain the hydraulic device after cooling the machine part, hydraulic oil and lubricating oil fully, because the residual heat and pressure will exist in the hydraulic device soon after finishing the operation.

6.7.1 Hydraulic Components

Notice!

Hydraulic components

- Discharge the air in the hydraulic oil tank to release its inner pressure
- Cool the machine. Check and maintain the high-temperature or high-pressure parts, because they may cause the sudden flyout or spray of parts or hydraulic oil and the personal injury.
- In case of removing the plug, don't make your body and face against them, because any hydraulic part may still have a certain pressure even if the part has been cooled.
- Don't try to maintain or check the traction or rotary motor circuit on the slope, because they can have high pressures due to their own weights.
- During the connection to the hydraulic hose and pipe, pay special attention to the seal surfaces to ensure no dirt exists on them, and avoid the damages to them.

Remember the following points:

- Clean the inner face of hose, pipe or oil tank with cleaning fluid, and dry them thoroughly before connecting them.
- Use non-destructive or defective O-rings, and don't damage them during the assembling.
- During the connection of hose, don't make the high-pressure hose distorted, because the lifetime of twisted hose will be greatly reduced. Tighten the low-pressure hose clamp cautiously and ensure they can't be screwed too tight.
- In case of filling the hydraulic oil, use the oil of the same brand always, and don't mix the oils of different brands.
- In case of wishing to use the oil listed in “**Brands and Names of Recommended Hydraulic Oils**”, ensure that all the hydraulic oil in the system is fully replaced.
- Don't run the engine without oil in hydraulic oil tank.

Caution!

Do not run the engine without oil in hydraulic oil tank!

6.7.2 Hydraulic Oil – Oil Filter - Oil Change

Notice!

Hydraulic Oil Level Check



Caution!

The hydraulic oil tank has a certain pressure!

- Release the pressure of oil tank and remove the cover carefully before removing the oil tank cover!
- Release the pressure firstly, don't loosen the drain plug before cooling the oil, because the oil may be hot and cause the severe scald injury!

The hydraulic oil may be hot, and the oil must be cooled before starting the work

Notice!

Hydraulic Oil Level Check



- Check the level of hydraulic oil every day.
 - Park the machine on the flat ground.
 - Retract the state positioner fully with arm hydraulic cylinder and stretch it out fully with a bucket hydraulic cylinder.
 - Stop the engine as per the shutdown steps of engine.
 - Pull the safety locking rod to LOCK (Lock).
 - Open the access door at the hydraulic pump, check the liquid-level meter on hydraulic oil tank.
- The oil level must be between the marks on the level meter, otherwise add the hydraulic oil.

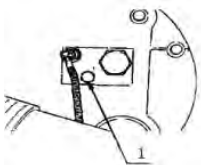

1 – Dirt drain plug

- Add the hydraulic oil and check the level meter again.
- Attach the cover and ensure the components of filter and hanger rod are correctly positioned.
- After cooling the oil, loosen the drain plug in the bottom of hydraulic oil tank, and drain the water and deposits.
- Don't remove the plug fully, and you'd better loosen it enough to drain the water and deposits.
- After draining the water and deposits, tighten the drain plug again.

Notice!

Drain the dirt reserve tank of hydraulic oil tank

Important: don't run the engine without oil in hydraulic oil tank.

- Drain the dirt reserve of hydraulic oil tank every 250 hours.
- For the convenience of access, rotate the upperstructure by 90°, and park the machine on the flat ground.
- Stop the engine as per the shutdown steps of engine.

Important: if the shutdown steps of engine are incorrect, the turbo supercharger may be damaged.

- Pull the safety locking rod to LOCK (lock).

Notice!

Replacement of Hydraulic Oil or Cleaning of Oil Suction Filter

Caution!

- The hydraulic oil may be hot, and the oil must be cooled before starting the work
- The hydraulic oil tank has a certain pressure. Release the pressure, and then remove the oil tank cover
- Starting the engine without hydraulic oil in hydraulic pump, it will damage the hydraulic pump.

Notice!

Replacement of hydraulic oil or cleaning of oil suction filter



1-Oil tank cover-



2-Oil drain plug-

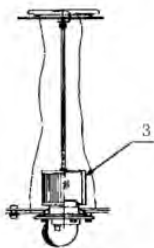

3 - Components of oil suction filter and hanger rod



4-air bleed plug-

- Replace hydraulic oil and oil suction filter element every 2000 hours.
 - o For the convenience of access, rotate the upperstructure by 90°, and park the machine on the flat ground.
 - o Retract the state positioner fully with arm cylinder and stretch it out fully with a bucket cylinder.
- Stop the engine as per the shutdown steps of engine.

Important: if the shutdown steps of engine are incorrect, the turbo super charger may be damaged.

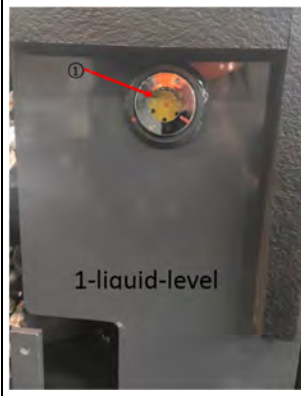

 - o Pull the safety locking rod to LOCK (lock).
 - o Clean the top of hydraulic oil tank and prevent the dirt from intruding into the hydraulic system.
- Remove the oil tank cover.
- Draw off the hydraulic oil with a pump.
- The **capacity of hydraulic oil in the tank: XE40: 70L.**
- Remove the drain plug to discharge the hydraulic oil.
- Take out the components of oil suction filter and hanger rod.
- Clean inner sides of filter and oil tank. In case of replacing the filter, attach a new filter to the hanger rod as shown in the right figure.
- Attach the components of filter and hanger rod, and ensure the filter is correctly fixed on the outlet.
- Replace the oil filter of hydraulic oil tank (refer to “List of Maintenance Periods”).
- Clean, attach and tighten the drain plug.
- Fill the hydraulic oil up to its level between the marks of level meter.
- Attach the oil tank cover and ensure the components of filter and hanger rod are in correct positions.
- Remove the air bleed plug from the top of hydraulic pump.
- Fill up the hydraulic pump with hydraulic oil through the hole of air bleed plug.
- Attach the air bleed plug.
- Start the engine and run it at low speed and empty load. Hang “No Operation” nameplate to the safety locking rod and ensure the safety locking rod in LOCK (lock) position.
- Loosen the air bleed plug slowly to discharge the accumulated air. When the flow of air stops and the oil is discharged out of the plug hole, tighten the plug.
- Run the engine at low speed and empty load, and actuate the operating lever slowly or stably for 15 minutes to discharge the air out of the hydraulic system.
 - Retract the state positioner fully with arm cylinder, and stretch it out fully with a bucket cylinder.
 - Stop the engine as per the shutdown steps of engine.
 - Pull the safety locking rod to LOCK (lock).



- Check the level meter of hydraulic oil tank. If necessary, open the oil tank cover to add in the oil.

6.8 Maintenance of Oil System

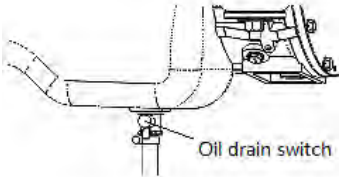
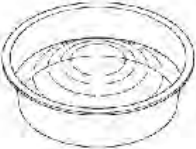
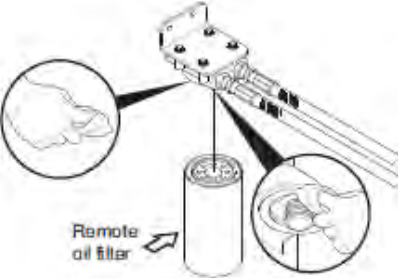
6.8.1 Replacement of engine oil and oil filter

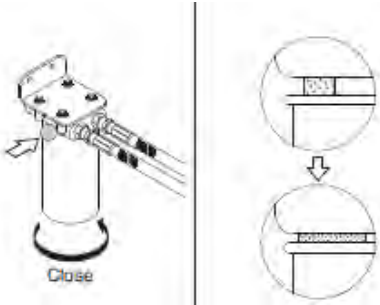
Notice	Replacement of engine oil and oil filter
 <p>Oil drain switch</p>   <p>Remove oil filter</p>  <p>Oil</p>  <p>Close</p>	<ol style="list-style-type: none">1. Operate the engine until the coolant temperature reaches 60°C. Shut off the engine.2. Turn the oil drain switch to drain the oil immediately to be sure all the oil and suspended contaminants are removed from the engine. A drain pan with a capacity of 30 liters will be adequate.3. Open the right door. Clean the area around the lubricating oil filter head.4. Use oil filter wrench to remove the oil filter.5. Clean the gasket surface of oil filter head. <p>NOTE: The O-ring can stick to the filter head. Be sure it is removed before installing the new filter.</p> <ol style="list-style-type: none">6. Apply a light film of lubricating oil to the gasket sealing surface before installing the filter. <p>NOTE: Fill the filters with clean lubricating oil.</p> <ol style="list-style-type: none">7. Install the filter to the filter head. Tighten the filter until the gasket contacts the filter head surface. Tighten 3/4 to 1 turn after the gasket makes contact with the filter head. <p>NOTE: Mechanical over-tightening may distort the threads or damage the filter element seal.</p> <ol style="list-style-type: none">8. Shut the oil drain switch off.9. Open the engine cover and fill the engine with clean oil to the proper level. Quantity: 11L.

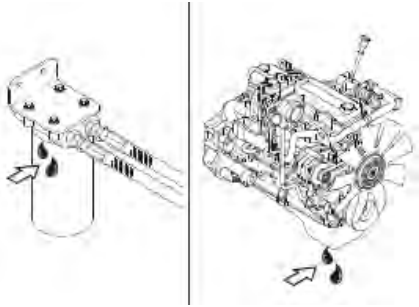

10. Operate the engine at low idle and inspect for leaks at the filter and the drain switch. Shut the engine off and check the oil level with the dipstick. Allow 15 minutes for oil to drain down before checking.

6.9 Maintenance of Fuel System

6.9.1 Fuel Tank

Notice!

Fuel Tank – Dirt Drain

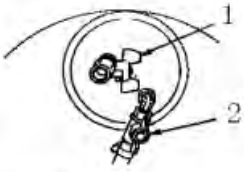

1 – Drain ball valve

2 – Fuel ball valve

- Drain the dirt reserve tank of fuel tank every day.
- For the convenience of access, rotate the upperstructure by 90°, and park the machine on flat ground.
- Stop the engine as per the shutdown steps of engine.
- Pull the safety locking rod to LOCK (lock).
- Open the drain plug at the bottom of fuel tank for several seconds to discharge the water and deposits, and then close the plug.

6.9.2 Water Separator

Notice!

Water Separator Check



- Check the water separator before the operation every day.
- The water separator may mix the water in fuel. The water separator contains a floating body that will float up during the accumulation of water to ensure the water separator starts to drain when the floating body reaches the mark of “drain water” on the outer side of water separator.
- Important: if the fuel contains excessive water, shorten the check interval of water separator.

Drain steps

- The water separator is located at the rear of the engine compartment, and nearby the air cleaner.
- Loosen the air bleed plug on the top of fuel prefilter, and anticlockwise loosen the drain plug in the bottom of water separator to drain the water accumulated in water separator.
- After draining the water, tighten the air bleed plug and drain plug. Turn the fuel ball valve to its original position.
- Start the engine, and check whether there is leakage of the plug and air bleed plug.

Note: ensure that the air is bled out of the hydraulic system after draining the water.

⚠ Caution!

The air in fuel system may cause the starting difficulty or abnormal starting of engine.

After draining the water and deposits in water separator, replacing the fuel filter or drying the fuel tank, ensure the air must be bled out of hydraulic system.

Notice!

Bleed the water out of Fuel System

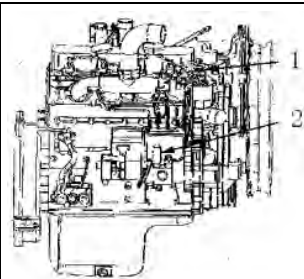

1 – Air bleed plug



Fuel supply pump.

- Determine that the drain plug and air drain plug of water separator are tightened.
If the air bleed plug is not tightened, the air in fuel system won't be exhausted.
 - Ensure the fuel ball valve in the bottom of fuel tank has been opened.
 - Loosen the air bleed plug on the fuel filter.
 - Loosen the hand wheel on fuel supply pump and move the plunger up and down until no air bubbles are seen from the air bleed plug.
 - Tighten the air bleed plug and continue to move the plunger of fuel supply pump up and down until the load becomes heavier.
 - Push down the hand wheel of fuel supply pump and tighten it.
- Start the engine and run it at low speed** and empty load.
- Hang “No Operation” nameplate to the operating lever.
 - Pull the safety locking rod to Lock position.
 - Check the hydraulic system for leaks.

6.9.3 Fuel Filter

Notice!



Fuel supply pump

Cartridge
filter

Replacement of fuel filter

- **Replace the fuel filter every 250 hours.**
- For the sake of safety and environmental protection, use the proper containers always for draining the fuel. Don't pour the fuel on the ground, into the ditch, river, pond or lake, and treat the waste fuel properly.
- Remove the cartridge filter with a filter spanner.
- Apply a thin layer of clean fuel to the gasket of new cartridge filter.
- Tighten the cartridge filter by hands until the gasket contacts the seal face.
- Turn the cartridge filter by 2/3 circle with a filter spanner to tighten it, but it shall not be screwed too tight.
- After replacing the cartridge filter, bleed the air out of fuel system.
- The above methods are for the replacement of second-class fuel filter on the engine side, and those of first-class fuel filter on the pump chamber side are the same as the above methods.

6.10 Maintenance of Clean Air System

6.10.1 Air Cleaning Filter

Notice!

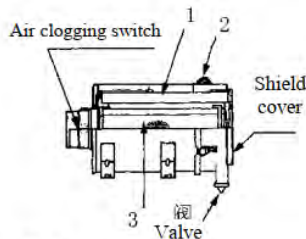

- 1—Outer filter element
- 2—Fixing clip
- 3—Inner filter element

Cleaning/Replacement of Outer Air-Filter Element

– Cleaning:

- Clean the outer element of air filter every 250 hours or when the warning lamp of air filter element brightens, clean the outer element of air filter.

Replacement of inner and outer elements of air filter:

– After six-time cleanings or one year, replace inner and outer elements of air filter.

- Park the machine on flat ground.
- Stop the engine as per the shutdown steps of engine.
- Pull the safety locking rod to LOCK (lock).
- Loosen the fixing clip and remove the end cover.
- Remove the outer filter element.
- Flap outer filter element lightly by hands.
- In case of cleaning outer filter element with compressed air, blow outward from inner side of outer filter element.
- Attach the outer filter element.
- Attach the end cover and tighten the fixing clip.
- Start the engine and run it at low speed and empty load.
- Check the warning indicator of air filter element on the monitor. If the indicator goes on, stop the engine immediately and replace the outer filter element.

In case of replacing the element of air filter, replace inner and outer filter elements together.

- Remove the outer filter element; clean the inner sides of filter before removing the inner filter element; remove the inner filter element; install the inner filter element, and then install the outer filter element.

6.11 Maintenance of Engine Cooling System

⚠ Caution!

- Unless the system has been cooled, don't loosen the radiator cap!
- Release the whole pressure before removing the cover, and then screw it off slowly!
- Protect your eyes and wear the gloves

6.11.1 Coolant Level

Notice!

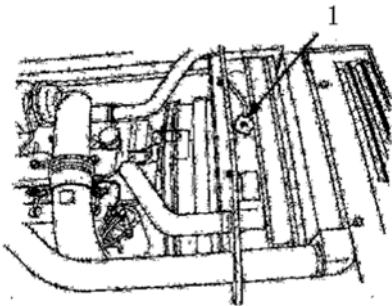

Coolant Level Check

- Check the level of coolant every day!
- The level of coolant must be between the marks FULL and LOW on coolant tank. The water tank shall be located behind the radiator shed door. If the coolant level is below LOW mark, add the coolant into the water tank. If the water tank is empty, add the coolant into the water tank after adding the coolant into the radiator.

6.11.2 Cleaning and Coolant Exchange

Notice!

Cleaning

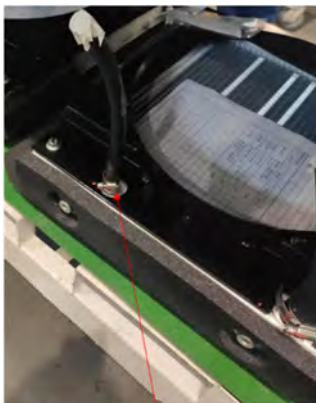

Radiator drain cock

- During the replacement of coolant, clean the inner side of radiator.
- Remove the radiator cap, open the drain cocks of radiator and engine body to empty the coolant.
- Close the drain cock, add fresh water and radiator cleaner into the radiator, start the engine and run it at the speed higher than low idle speed. When the pointer of cooling water thermometer enters into the green area, continue to run the engine for over ten minutes.
- Close the engine, open the drain cock, and flush the cooling system with fresh water until the drained water becomes clean so as to remove the dirt and deposits.
- Close the drain cock, add the fresh water, and add the antirust agent and antifreeze agent into the radiator as per the specified mixing ratio. In order to prevent the air bubble from mixing into the system, add in the coolant slowly.
- Run the engine to bleed the air of cooling system fully.
- After adding in the coolant, make the engine running for several minutes. Check the level of coolant again and add in the coolant again according to the demands.

6.12 Electric and Control System

 Caution!	<ul style="list-style-type: none"> – The installation of improper radio communicators and accessories will influence the electronic elements of machine and cause the unexpected movement of machine. – The installation of improper electric devices may also cause the fault or accidental fire. – During the installation of radio communicators or additional electric components or replacement of these components, be sure to consult with the assigned dealer. – Don't attempt to disassemble or modify any electric or electronic component. – If it's necessary to replace or modify these components, contact with the assigned dealer.
---	---

6.12.1 Battery

 Caution!	<ul style="list-style-type: none"> – The gas of battery can cause the explosion, prevent the spark and flame from approaching the battery.
Notice!	<ul style="list-style-type: none"> – This machine adopts the maintenance-free battery, so it's unnecessary to add in the water frequently. – Check the capacity of battery frequently to increase its lifetime.

Notice!	<ul style="list-style-type: none"> – Battery Check – Check the capacity of battery at least once every month. – Park the machine on flat ground. – Stop the engine as per the shutdown steps of engine. – Check the capacity of battery. Observe the densimeter from the upper part of battery. – If the following circles are seen from round porthole: <ul style="list-style-type: none"> – Green circle—indicates the normality of battery – Black circle—indicates the low capacity of battery that needs to be charged – White circle—indicates the discarding of battery that needs to be replaced. – Keep the terminal of battery clean always to avoid the discharge of battery. Check the terminals for loosening or rusting, and apply the grease or Vaseline to avoid the corrosion
----------------	--



Position of battery.



1—Level meter 2—Porthole

Notice!	<ul style="list-style-type: none"> – Battery Replacement – There are two negative (-) grounded 12V batteries on the machine.
----------------	---

- If one battery of 24V system fails but the other is still good, replace the failed battery with the battery of the same type.
- For example, replace the failed and maintenance-free battery with new battery.
- The charging speeds of batteries in different forms may be different, which may make one of these batteries fail due to overload.

6.12.2 Electric Fuses

Notice!

Fuse Replacement

- If the electric device doesn't work, check the fuse at first.
- **The fuse box is located behind the seat**, open the fuse box cover up, and the spare fuse is located under the cover.
- Important: avoid the damages to electric device due to overload, and install the fuse with correct amperage.

钥匙开关 Key switch	10A	备用 Spare	10A
熄火阀 R Flameout valve R	5A	熄火阀 W Flameout valve W	30A
预热继电器 Preheat relay	5A	监控器 Monitor	10A
安全阀 Monitor	5A	换速阀 H/L Speed	5A
切换阀 Dozer/Cauge	5A	喇叭 Harn	10A
燃油填充泵 Fuel pump	5A	臂灯 Arm lamp	10A
备用 Spare	30A	备用 Spare	5A

Name	Rated Current	Name	Rated Current
Key switch	10A	Spare	10A
Flameout valve R	5A	Flameout valve W	30A
Preheat relay	5A	Monitor	10A
Monitor	5A	H/L Speed	5A
Dozer/Cauge	5A	Harn	10A
Fuel pump	5A	Arm lamp	10A
Spare	30A	Spare	5A

6.13 Bucket Maintenance



Caution!

- Avoid the injury caused by the flyout of metal filling or fragments in case of hitting out or in the connecting pin
- Wear the safety goggles/safety glasses, gloves and safety appliances applicable for operation.

Notice!

Replace the bucket

Movement of O-ring

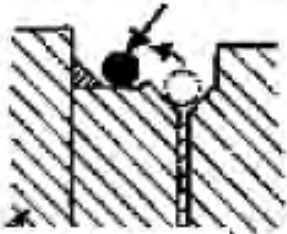

Bucket sleeve

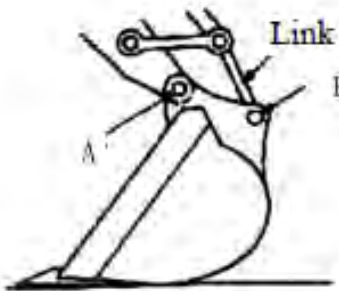

- Park the machine on flat ground. Lower the bucket to ground, fix its plane on the ground, and ensure the pin shaft can't be rolled after removing the pin shaft.
- Slide O-ring out as shown in Figure.
- Remove bucket pin shafts A and B, separate the arm and bucket, clean pin shaft and pin hole, and apply enough lubricating oil to pin shaft and pin hole.
- Align the arm and new bucket, and ensure the bucket can't roll.
- Attach the bucket pin shafts A and B.
- Attach the lock pin and retaining ring to pin shafts A and B.
- Adjust connecting clearance of bucket at pin shaft A (see "Adjust connecting clearance of bucket").
- Apply the grease to pin shafts A and B.
- Start the engine and run it at low idle speed. Turn the bucket slowly in both directions to check if the rotation of bucket is disturbed. Don't use any disturbed machine. If any disturbance, deal with it in time.

Notice!

Adjustment of bucket joint gap

- There is a regulation system of bucket connection gap capable of eliminating the connection slashing. When the connection slashing is increased, remove or attach the tab as described below.
- Park the machine on flat ground, lower the bucket to ground with its plane down to avoid rolling the bucket.
- Run the engine at low idle speed, turn the bucket clockwise on the ground until left boss top of bucket contacts the arm.
- Stop the engine. Pull the safety locking rod to LOCK (lock).
- Note: in case of removing the tab, don't remove the bolt (Item 1 shown in Figure). The tab is half round, so it's easy to push them out with a screwdriver after loosening the bolt.



- 1-Bolt
- 2-Adjusting shim
- 3-Pressure plate 4-Cam

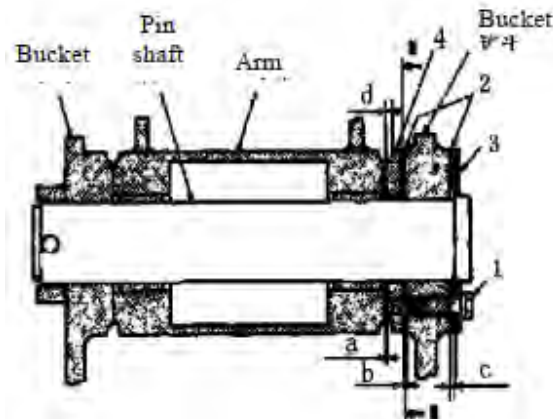

- Loosen the bolt slightly with a spanner. Push out all the tabs in the clearance c between the pressure plate and bucket.
 - Push the bolt to one side of arm, and eliminate the whole clearance a between arm and cam. Push the cam onto the arm to increase the clearance b, and measure the clearance b with a feeler gauge, which shall not be adjusted below 0.5mm.
 - Attach the adjusting shims as much as possible in the clearance b.
- Note: be sure to attach the residual adjusting shims in the clearance c to avoid the damages to arm tail end face or bolt.
- Attach the residual tabs in the clearance c and tighten the bolt.
- Note: the total number of tabs is 12 (6 pairs).
- If the measured value d is below 5mm, replace the cam.

6.14 Traction Maintenance

6.14.1 Traction Operating Lever

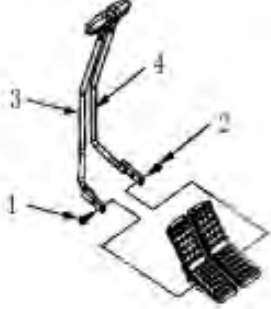
Notice!	Removal of traction operating lever
 <p>1, 2 – Bolt</p> <p>3, 4 – Traction control lever</p>	<ul style="list-style-type: none"> – If necessary, remove the traction operating lever. – Lower the bucket to ground. – Stop the engine as per its shutdown steps. – Pull the safety locking rod to LOCK (lock). – Remove the bolts 1 and 2, and remove the traction operating levers 3 and 4 from the control valve.

6.14.2 Track Sag

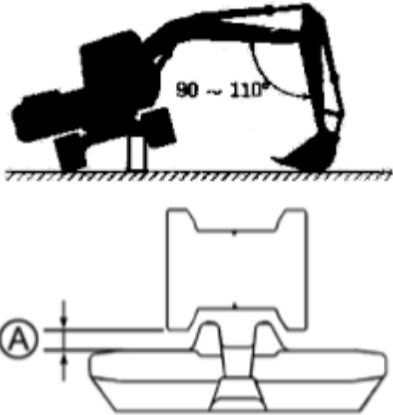
Notice!	Check of track sag						
	<ul style="list-style-type: none"> – Check the track sag every day. <ul style="list-style-type: none"> ○ If the crawler are too light, wear is increased. ○ If the crawler are too loose, wear is increased and the crawler may come off. – As shown in Figure, rotate the upperstructure by 90°, and then lower the bucket to lift the track approx. 200 mm off the ground, keep the angle between the boom and arm within 90° to 110°, place the arc part of bucket on the ground, place the cushion block under the frame of chassis to support the machine, rotate the track back by two circles, rotate it forward by two circles, and measure the distance A (between the track roller and the inside surface of the track) from the middle part of chassis frame. – Requirements of track sag: <table border="1" data-bbox="641 1361 1166 1525"> <thead> <tr> <th>Crawler type</th> <th>A(sag)/mm</th> </tr> </thead> <tbody> <tr> <td>Rubber</td> <td>10-15</td> </tr> <tr> <td>Steel</td> <td>75-80</td> </tr> </tbody> </table> – If the crawler loosen more than 25mm (rubber) or 50mm(steel), readjust the crawler. – If necessary, tighten or loosen the crawler. – Start the excavator and rotate the lifted crawler carefully. <p>Note:</p> <ul style="list-style-type: none"> – Check the slag of track after removing the soil on the track plate. <p>Clean all parts of the running gear, paying particular attention to stones between the crawler and sprocket or idler. Clean the area of the crawler tension cylinder.</p>	Crawler type	A(sag)/mm	Rubber	10-15	Steel	75-80
Crawler type	A(sag)/mm						
Rubber	10-15						
Steel	75-80						

6.14.3 Track Adjustment



Caution!

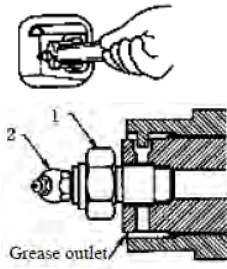

1— Valve body
2— Grease coupler

- Don't loosen the valve body rapidly or excessively, otherwise the grease in the tensioner will spray. Loosen the valve body carefully, and don't make the body and face against it.
- Don't loosen the grease coupler.
- Important: if the crushed stones or soils are clipped between the sprocket and track remove them after loosening the track.
- If the track is still too tight after tightening the valve body anticlockwise, or it is still loose after applying the grease into the grease coupler, this is abnormal.
- At this time, don't try to remove the track or track-tension device, because the high-pressure grease of track-tension device is dangerous.
- Therefore, overhaul it or contact with your assigned dealer.

Notice!

Adjust the sag of track.

- Points for attention for adjusting the track sag
- If the track sag is not within the desired range, loosen or tighten the track as per the steps below.
- During the adjustment of track sag, lower the bucket to ground, and jack the track on one side.
- Apply the same method to the track on the other side. Place the cushion block under the frame every time to support the machine.
- After adjusting the track sag on both sides, move the machine forward and backward several times.
- Check the sag of track again. If the track sag can't reach the specified value, continue to adjust it until it's satisfactory.
- Loosen the track.
- In case of loosening the track, rotate the valve body slowly anticlockwise with a deep socket wrench, and the grease will be drained out of its outlet.
- Rotate the valve body by 1 to 1.5 circles enough to loosen the track.
- If the grease can't be smoothly drained, lift the track away from the ground, and rotate the track slowly.
- After reaching the proper track sag, tighten the valve body clockwise.
- Tighten the track.
- If it's necessary to tighten the track, connect the grease gun to grease coupler, add in the grease until the track sag reaches the specified value.

6.15 Safety Seat-Belt

Notice!



1-Safety belt 2-Lock latch

3-Connector

Check and replacement of safety belt

- Check the safety belt every day; replace the safety belt every 3 years.
- Keep the safety belt always good, and replace it if necessary to ensure its good performance.
- Check the safety belt; lock latch and connector thoroughly before the operation.
- If the safety belt or its part is damaged or worn, replace it before the operation.
- We suggest that the safety belt shall be replaced every three years, regardless of its conditions.

6.16 Bolt Tightening Torques

Notice!

- **Check the tightening torques of bolt and nut every 250 hours.**
- After the first 50 hour breaking-in period of machine, check the tightness of bolt and nut, and then check it every 250 hours. If loose, tighten the bolt up to the torque shown in Tightening of Bolt. In case of replacement, replace it with the same or higher-class bolt and nut. For the bolt and nut outside Tightening of Bolt, refer to “Tightening Torques”.
- Important: check or tighten the bolt and nut with a torque wrench.

Bolt specification	Size of socket wrench Mm	Size of inner hexagonal wrench mm	Torque Nm	
			10.9 class	8.8 class
M8	13	6	30	20
M10	16	8	70	50
M12	18	10	120	90
M14	21	12	195	140
M16	24	14	300	210
M18	27		410	300
M20	30	17	600	400
M22	34		800	550
M24	36	19	1000	700
M27	41		1500	1050
M30	46	22	1850	1450
M36	55	27	3000	2450

Note: the desired tightening torque is expressed in Nm.

For example, in case of tightening the bolt or nut with a 1m long wrench, turn the tail end of wrench by a force of 120N, and create the following torques:

1m X120 N=120 Nm

In case of creating the same torque with a 0.25m wrench:

0.25m x =120Nm

The desired force shall be: 120 /0.25=480 N

S/N	Item		Bolt diameter mm	Qty	Sleeve size mm	Torque Nm
1	Fixing nut of engine vibration isolating rubber gasket		10	8	16	70
2	Fixing bolt and nut of engine bearer		10	8	16	70
3	Fixing bolt of hydraulic oil tank		10	2	18	70
4	Fixing bolt of fuel tank		8	2	13	30
5	Fixing bolt of hydraulic pump		12	2	18	120
6	Fixing bolt of multi-way valve		8	3	16	30
7	Fixing nut of cab		16	4	24	210
8	Fixing bolt of swing bearing (upper)	XE17U	12	16	18	120
	Fixing bolt of swing bearing (lower)	XE17U	12	18	18	120
9	Fixing bolt of sprocket		10	8	16	70
10	fixed bolt of carrier side plate		8	16	13	30
11	Fixing bolt of carrier roller		12	6	18	120
12	Fixing bolt of track roller	XE17U	10	6	16	70
13	Counterweight mounting bolt	XE17U	16	2	24	210

6.17 Hammer-Breaker Maintenance

Notice!	Hammer Breaker
	<ul style="list-style-type: none"> – The operation of hydraulic hammer breaker will accelerate the pollution and deterioration of hydraulic oil. Therefore, in comparison with the machine with a bucket, require to replace the hydraulic oil and hydraulic oil tank filter frequently, otherwise the hammer breaker, hydraulic oil pump and other components of hydraulic system may be damaged, and adopt the following recommended replacement intervals.

Table 2-6 Replacement Intervals (Hours)

Accessory	Utilizing rate	Hydraulic oil	Filter element
Bucket	100%	2000	500
Hammer crusher	20%	400	100
	40%	600	100
	60%	800	200
	80%	1600	200

Notice	Change periods of hydraulic oil and filter element - Follow the advice:
	<ul style="list-style-type: none"> – The change periods of the hydraulic oil and/or its filter element depend on the hydraulic knapper's duration and intensity of use. These change intervals usually coincide with the regular maintenance intervals. – When using the hydraulic knapper, the hydraulic oil will be contaminated rapidly. Its viscosity will drop faster since the operating condition is more stressful for the system than for digging. – Refer to the table below to change hydraulic oil and replace the filter element. It will help to avoid shortening the lifespan of hydraulic parts due to the hydraulic oil contamination (especially in the main pump).

6.18 Special Maintenance Conditions

Operating conditions	Maintenance cautions
Mud field, rainy or snowy	Pre-operation: check if the screw plug and all the drain plugs are tightened. After-operation: clean the machine, and check if there are broken, damaged, loose or missing nut and bolt, and lubricate all the required parts immediately.
Seaside	Pre-operation: check if the screw plug and all the drain plugs are tightened. After-operation: clean the machine thoroughly with clean water to remove the salt content, and maintain the electric appliances frequently to avoid their corrosion.
Dusty air	Air filter: clean the filter elements at regular service intervals. Radiator: clean the mesh enclosure of oil cooler to avoid the blockage of radiator core. Fuel system: clean the filter elements and sieve at regular short service intervals. Electric appliances: clean them at regular intervals, especially the terminals of AC generator and starting motor.
Frosty weather	Fuel: adopt the appropriate low-temperature high-quality fuel. Lubricant: adopt the high-quality low-viscosity hydraulic oil and engine oil. Engine coolant: be sure to adopt the anti-freezing agent. Battery: charge the battery up at short regular intervals. In case of not charging the battery up, the electrolyte may be frozen. Track: keep the track clean, and park the machine on the hard ground to avoid freezing the track on the ground.
Stony ground	Track: careful operation. Check if there are broken, damaged or missing bolts and nuts frequently, and loosen the track a little looser than usual. Equipment: in case of digging the stony ground, the standard accessories may be damaged, adopt the front reinforced bucket or heavy-duty bucket.
Falling rocks	Cab: if necessary, install the cab roof support to avoid the damages of falling rocks to the machine.

6.19 Maintenance of Engine

Notice!

See "Operating Instructions of Engine" in details

7 Faults and Troubleshooting

Notice!

Correct procedures of maintenance and check

In order to maintain and repair the machine correctly, follow the correct maintenance and check procedures described in this manual.

7.1 Periodic Replacement of Parts

Notice!

Periodic replacement of parts

In order to ensure the safety of operation. Check the machine at regular intervals. If any of the following parts is damaged, it may cause a severe accident or fire. The deterioration or damage of these parts is difficult to determine via a visual check, so these parts shall be replaced at the intervals shown in the table below, however, if they are found to be poor during the check, they shall be replaced before the operation of machine, regardless of the interval of replacement. In case of replacing the hose, it's also required to check their pipe clips for deformations, breakage or damages, and replace them according to the demands. Check all the following hoses at legal regular intervals and replace or tighten any poor part as per the demands.

7.2 Engine

Trouble	Cause	Remedy
Engine rotates, but it can't be started or difficult to start.	No fuel	Add in fuel, and exhaust the air.
	Wrong fuel	Empty the oil tank, and adopt the correct fuel.
	Polluted fuel	Empty the oil tank, and add in clean fuel.
	Low capacity of battery	Charge or attach a new battery.
	Trouble of injection pump	Contact with the assigned dealer of XCMG (Xuzhou XCMG Excavator Machinery Co., Ltd.)
	Trouble of preheat circuit or igniter plug	Contact with the assigned dealer of XCMG (Xuzhou XCMG Excavator Machinery Co., Ltd.)
	Poor contact of circuit	Clean and fix the connection of battery and starting motor.
	Trouble of starting motor	Replace the starting motor.
	Wrong engine oil	Drain the oil, and adopt the correct oil.
	Blockage of air filter	Replace the filter elements.
	Blockage of fuel filter	Bleed the air out of fuel system, and clean the sieve of fuel tank.
	Low compression ratio of engine	Contact with the assigned dealer of XCMG.
	Dirty nozzle or incorrect operation	Contact with the assigned dealer of XCMG.
	Trouble of fuel cutoff linkage	Adjust or repair the linkage.
	Leakage of fuel system	Check the connection of fuel system.
	Air exists in fuel system.	Bleed the air.
	Pop-up of fuel supply pump plunger	Push down and tighten the hand wheel.
Dirty transfer pump sieve	Clean or replace	
Shot noise, abnormal running or stoppage of engine	Low level of engine oil	Add in engine oil.
	Blockage of air suction system	Clean the filter system.
	Dirty transfer pump sieve	Clean or replace
	Off-time of injection pump	Contact with the assigned dealer of XCMG.
	Blockage of fuel filter	Renew the filter.
	Low temperature of cooling water	Incorrect operation of thermostat or it's too cold.
	Water, dirt or air exists in fuel system	Drain the air out of fuel system, and clean the outlet sieve of fuel tank.
	Dirt or trouble of nozzle.	Contact with the assigned dealer of XCMG.
	Fuel cutoff linkage trouble	Adjust or repair the linkage.
The engine can't function fully.	Blockage of air filter	Replace the filter elements.
	Blockage of fuel pipe	Repair or replace the fuel pipe.
	Polluted fuel	Empty the fuel tank and clean the outlet sieve, and add in the oil again.

	Blockage of fuel filter	Replace the filter.
	Blockage of fuel tank cover vent hole	Clean or attach a new cover.
	Dirt or trouble of fuel nozzle	Contact with the assigned dealer of XCMG.
	Adjustment required for injection pump linkage	Contact with the assigned dealer of XCMG.
	Wrong fuel	Adopt the correct fuel.
	Wrong engine oil	Adopt the correct engine oil.
	Trouble of turbo charger	Contact with the assigned dealer of XCMG.
	Off-time of injection pump	Contact with the assigned dealer of XCMG.
	Blockage of emission	Remove the muffler and run the engine.
	Overheat or overcooling of engine	See below
	Trouble of engine	Contact with the assigned dealer of XCMG.
	Leaks of air suction or bleeding system	Contact with the assigned dealer of XCMG.
Overheat of engine	Low level of cooling water	Add in cooling water.
	Trouble of thermostat	Contact with the assigned dealer of XCMG.
	Overload of engine	Check the hydraulic safety valve.
	Wear of radiator cap	Attach a new cap.
	Blockage of radiator core and oil cooler core	Clean the radiator and oil cooler.
	Blockage of radiator mesh enclosure	Clean the mesh enclosure.
	Off-time of injection pump	Contact with the assigned dealer of XCMG.
	Damage of fan	Replace the fan.
	Blockage of air filter	Clean the air filter.
	Loosening of AC generator and fan belt	Tension the belt or attach a new belt.
	Wear of belt pulley	Replace the belt pulley
	Dirty cooling system pipe	Flush the cooling system.
	Trouble of thermometer or transfer unit	Contact with the assigned dealer of XCMG.
Overlow temperature of cooling water	Trouble of thermostat	Contact with the assigned dealer of XCMG.
	Trouble of thermometer or transfer unit	Contact with the assigned dealer of XCMG.
Low pressure of engine oil	Trouble of engine oil pump or pump drive	Contact with the assigned dealer of XCMG.
	Low level of engine oil	Add in engine oil.
	trouble of engine oil pressure control valve	Contact with the assigned dealer of XCMG.
	Blockage of oil pump suction mesh enclosure	Contact with the assigned dealer of XCMG.
	Blockage of oil filter	Renew the oil filter.

	Leak of engine oil	Leak check.
	Engine oil is diluted by fuel or cooling water.	Contact with the assigned dealer of XCMG.
	Overhigh temperature of engine	Check the cooling system.
	Wrong engine oil	Drain the oil, and adopt the correct oil.
Excessive consumption of engine oil	Wrong engine oil	Drain the oil, and adopt the correct oil.
	Leak of engine oil	Check the engine oil drain plug.
	Overheat of engine	Check the cooling system.
	Blockage of air filter	Clean the filter element or attach new filter elements.
	Wear of inner parts of engine	Contact with the assigned dealer of XCMG.
Excessive consumption of engine fuel	Blockage or dirt of air suction system	Clean the air suction system.
	Wrong fuel	Adopt the correct fuel.
	Dirty fuel nozzle	Contact with the assigned dealer of XCMG.
	Off-time of injection pump	Contact with the assigned dealer of XCMG.
Too black or grey exhaust fume	Wrong fuel	Empty the oil tank, and adopt the correct fuel.
	Blockage or dirt of air suction or discharge system	Clean the air suction or discharge system.
	Off-time of injection pump	Contact with the assigned dealer of XCMG.
	Dirty fuel nozzle or its incorrect operation	Contact with the assigned dealer of XCMG.
	Trouble of engine body	Contact with the assigned dealer of XCMG.
Failure of engine	Trouble of battery	Charge or replace.
Insufficient capacity of battery	Loose connection or corrosion	Clean, tighten or replace the battery.
	Loosening of AC generator belt	Tension the belt or attach a new belt.
	AC generator fails to charge.	Contact with the assigned dealer of XCMG.
	Broken fuse	Replace the fuse.
	Trouble of key switch	Replace the key switch.
Starting motor can't rotate.	Insufficient capacity of battery or damaged	Charge or replace the battery.
	Poor connection of battery circuit	Clean the connection.
	Broken fuse	Replace the fuse.
	Trouble of key switch	Contact with the assigned dealer of XCMG.
	Trouble of starting relay	Contact with the assigned dealer of XCMG.
	Trouble of starting motor magnetic coil	Contact with the assigned dealer of XCMG.
	Trouble of starting motor	Repair or replace the starting motor.
	The starting motor pinion is clamped in the flywheel gear.	Repair or replace starting motor.
	Trouble of engine body	Contact with the assigned dealer of XCMG.

Magnetic vibration of starting motor	Poor connection of battery or starting motor circuit	Clean the connection part.
	Low capacity of battery	Charge or replace battery
	Opening of starting motor magnetic "hold" coil	Contact with the assigned dealer of XCMG.
The starting motor rotates but it can't be started.	Disengagement of starting motor pinion with the flywheel gear	Contact with the assigned dealer of XCMG.
	Seizure or trouble of pinion shift mechanism	Contact with the assigned dealer of XCMG.
	Fracture of pinion teeth	Contact with the assigned dealer of XCMG.
	Fracture of flywheel gear teeth	Contact with the assigned dealer of XCMG.
Slow starting of engine	Inner damages or fracture of battery leads	Check and replace the leads.
	Loosening of battery or starting motor connection or corrosion	Clean and tighten the connection.
The engine bleeds white gas.	Wrong fuel.	Empty the oil tank, and adopt the correct fuel.
	Low temperature of engine	Run the engine until it becomes hot.
	Trouble or overcooling of thermostat	Contact with the assigned dealer of XCMG.
	Off-time of injection pump	Contact with the assigned dealer of XCMG.
	Leak of cooling water into the cylinder of engine	Contact with the assigned dealer of XCMG.
Large noise or vibration of turbo charger	Bearing is not lubricated.	Insufficient oil pressure, check the blocked oil pipe of turbo charger
	Worn bearing	Contact with your assigned dealer.
	Air leaks of engine, suction or drain pipe	Check or repair.
	Improper gap between the turbine and turbine case	Contact with the assigned dealer of XCMG.
	Breakage of turbine blade	Remove the exhaust elbow and air inlet hose, and check them.
Oil dripping of turbo charger joint	Damage or wear of bearing and (or) worn seal	Contact with the assigned dealer of XCMG, check and clean the air filter, check if the service interval of engine is proper or dirt enters into the engine.
	Overhigh pressure of crankcase	Check the vent pipe, ensure the pipe is not blocked, and clean it.
	Blockage of turbo charger return pipe at the exhaust pipe	Remove the pipe, and check or clean it.
Too large resistance of turbo charger rotating member	The combustion deposits cause the blockage of coal behind the turbine.	check or clean
	Leaks of air suction pipe cause the blockage of dirt behind the compressor wheel.	check or clean

	Overhigh temperature, unbalanced impeller, dirty oil, lack of oil or insufficient lubrication causes the seizure, dirt and wear of bearing.	Contact with the assigned dealer of XCMG.
--	---	---

7.3 Electric System

Electric System cont'd

Trouble	Cause	Remedy
Slow starting of engine	Current leakage of battery or it can't hold the charge capacity.	Replace the battery.
	"Draggle" of starting motor	Contact with the assigned dealer of XCMG.
	Low voltage of battery	Charge or replace battery
The starting motor continues to run after starting the engine.	Trouble of starting relay	Contact with the assigned dealer of XCMG.
	Suction of starting motor magnetic coil	Contact with the assigned dealer of XCMG.
	The starting motor can't be disconnected.	Contact with the assigned dealer of XCMG.
	Trouble of key switch	Contact with the assigned dealer of XCMG.
The charging indicator goes on during the running of engine.	Loosening or slipping of AC generator belt	Check the belt, if slipped, replace it; if loose, tighten it.
	Low speed of engine	Adjust the speed to the specified value.
	Attached accessories cause the electric overload.	Remove the attached accessories or install higher-output AC generator.
	Loosening of battery, grounding steel strip, starting motor or AC generator, corrosion of electric connection	Check, clean or tighten the electric connection.
	Low voltage of battery	Charge or replace the battery.
	AC generator trouble	Contact with the assigned dealer of XCMG.
	Trouble of monitor	Contact with the assigned dealer of XCMG.
Fracas of AC generator	Worn driving belt	Replace the belt.
	Worn belt pulley	Replace the belt pulley and belt.
	Improper adjustment of belt pulley	Adjust the installation of AC generator
	Trouble of AC generator bearing	Loosen the belt of AC generator, and turn the belt pulley by hands. In case of feeling difficult to turn, repair AC generator.
Indicator of monitor can't go on.	Trouble of monitor	Contact with the assigned dealer of XCMG.
	Trouble of electric wiring	Contact with the assigned dealer of XCMG.
	Damaged fuse	Replace the fuse.
	Trouble of sensor.	Check the sensor.
	Damaged fuse	Replace the fuse.

The cooling water thermometer fails to work.	Trouble of thermometer	Contact with the assigned dealer of XCMG.	
	Trouble of temperature sensor	Check the sensor of cooling water thermometer.	
	Trouble of electric circuit	Contact with the assigned dealer of XCMG.	
The automatic idling indicator goes out.	Damaged fuse	Replace the fuse.	
	Trouble of automatic idling switch	Contact with the assigned dealer of XCMG.	
The fuel meter can't work.	Damaged fuse	Replace the fuse.	
	Damaged fuel meter	Contact with the assigned dealer of XCMG.	
	Trouble of electric circuit	Contact with the assigned dealer of XCMG.	
Working mode toggle fails to work.	Trouble of mode toggle	Contact with the assigned dealer of XCMG.	
	Damaged electric joint	Contact with the assigned dealer of XCMG.	
	Trouble of monitor	Contact with the assigned dealer of XCMG.	
Fast/slow driving speed deactivates.	Trouble of driving mode switch	Contact with the assigned dealer of XCMG.	
	Trouble of monitor	Contact with the assigned dealer of XCMG.	
	Trouble of solenoid valve	Contact with the assigned dealer of XCMG.	
	Damaged running motor	Contact with the assigned dealer of XCMG.	
Automatic idling deactivates.	Damaged fuse	Replace the fuse.	
	Trouble of pilot pressure switch	Contact with the assigned dealer of XCMG.	
	Trouble of electric circuit	Contact with the assigned dealer of XCMG.	
	Trouble of engine control motor	Contact with the assigned dealer of XCMG.	
	Trouble of main controller	Contact with the assigned dealer of XCMG.	
The trouble indicator flashes.	Once or brighten.	Contact with the assigned dealer of XCMG.	Contact with your assigned dealer.
	Twice	Abnormal current of motor	Contact with the assigned dealer of XCMG.
	Three times	Pause of motor action	Contact with the assigned dealer of XCMG.
	Four times	Motor poor in the range of action	Contact with the assigned dealer of XCMG.
	Five times	Broken circuit or short circuit of built-in potentiometer of motor	Contact with the assigned dealer of XCMG.

	Six times	Set broken circuit or short circuit of potentiometer	Contact with the assigned dealer of XCMG.
	Seven times	Abnormal current of magnetic coil	Contact with the assigned dealer of XCMG.
	Eight times	Overflow speed of engine	Contact with the assigned dealer of XCMG.
	Extinguish	Trouble of controller	Contact with the assigned dealer of XCMG.

7.4 Hydraulic System

Hydraulic System cont'd

Trouble	Cause	Remedy
Slow hydraulic function	Low level of hydraulic oil	Fill the hydraulic oil up to full scale.
	Low temperature of hydraulic oil	Preheat the machine.
	Wrong use of hydraulic oil	Empty the oil tank, and adopt the correct hydraulic oil
	Overlow speed of engine	Accelerate or contact with your assigned dealer.
	Wear of hydraulic pump	Contact with the assigned dealer of XCMG.
	Blockage of pump suction pipeline	Contact with the assigned dealer of XCMG.
Overheat of hydraulic oil	Wrong use of hydraulic oil	Adopt the correct hydraulic oil
	Air leak of pump oil suction pipeline	Contact with the assigned dealer of XCMG.
	Blockage of hydraulic pipeline	Contact with the assigned dealer of XCMG.
	Low level of hydraulic oil	Fill the hydraulic oil to full scale.
	Blockage of filter	Attach a new filter
	Wear of hydraulic pump	Contact with the assigned dealer of XCMG.
	Blockage of radiator or oil cooler	Clean and straighten the blade.
	Bypass of oil cooler	Contact with the assigned dealer of XCMG.
	Trouble of safety valve	Contact with the assigned dealer of XCMG.
	Polluted hydraulic oil	Drain the oil and fill it up.
	Improper adjustment of hydraulic components	Contact with the assigned dealer of XCMG.
Foaming of hydraulic oil	Air leak of the pipe from oil tank to pump	Contact with the assigned dealer of XCMG.
	Twist or depression of hydraulic pipeline	Check the pipeline.
	Wrong hydraulic oil	Adopt the correct hydraulic oil.
	Water in hydraulic oil	Replace the hydraulic oil.
	Overhigh or overlow oil level	Calibrate the oil level.
Low or no oil pressure	Wrong hydraulic oil	Adopt the correct hydraulic oil.
	Improper adjustment of hydraulic components	Contact with the assigned dealer of XCMG.
	No hydraulic oil in the system	Fill up the correct hydraulic oil.
	Worn hydraulic cylinder packing	Contact with the assigned dealer of XCMG.
	Trouble of safety valve	Contact with the assigned dealer of XCMG.
No hydraulic function (fracas of pump)	Wear of hydraulic pump	Contact with the assigned dealer of XCMG.
	Reduction of set pressure of main safety valve of control valve	Contact with the assigned dealer of XCMG.
	Low level of hydraulic oil	Fill up the hydraulic oil.
	Damage of oil suction pipeline or hose	Contact with the assigned dealer of XCMG.





	Blockage of suction filter, and air sucked in oil suction.	Clean the filter system.
The hydraulic cylinder acts but it can't lift the load.	Wear of hydraulic pump	Contact with the assigned dealer of XCMG.
	Low pressure of main safety valve	Contact with the assigned dealer of XCMG.
	Low level of hydraulic oil	Fill up the hydraulic oil.
	Blockage of suction filter	Clean the filter system.
	Leakage of pump suction pipeline	Check the oil suction pipeline.
One operating lever fails to work.	Low pressure of safety valve	Contact with the assigned dealer of XCMG.
	Damage of pipe or hose	Repair or replace
	Loosening of hydraulic joint	Tighten.
	Damage of O-ring in the joint	Attach a new O-ring.
	hydraulic pump trouble	Contact with the assigned dealer of XCMG.
	Trouble of pilot valve	Contact with the assigned dealer of XCMG.
	Damage of pilot pipeline	Repair or replace
One hydraulic cylinder fails to work.	Control valve column is damaged or polluted by dirt.	Contact with the assigned dealer of XCMG.
	Damage of hydraulic pipeline	Repair or replace
	Loosening of joint	Tighten.
	Damage of O-ring in the joint	Attach a new O-ring.
	Trouble of pilot valve	Contact with the assigned dealer of XCMG.
	Damage of pilot pipeline	Repair or replace
One hydraulic cylinder fails to work or almost deactivates.	Leakage of hydraulic cylinder seal	Contact with the assigned dealer of XCMG.
	Damage of hydraulic cylinder lever	Contact with the assigned dealer of XCMG.
	Damage of pilot pipeline	Repair or replace
	Trouble of pilot valve	Contact with the assigned dealer of XCMG.
	Trouble of circuit	Contact with the assigned dealer of XCMG.
Two travel motors fail to work.	Trouble of center sub body	Contact with the assigned dealer of XCMG.
One travel motor fails to work	Trouble of travel motor	Contact with the assigned dealer of XCMG.
	Unreleased of brake	Contact with the assigned dealer of XCMG.
	Trouble of pilot valve	Contact with the assigned dealer of XCMG.
	Damage of pilot pipeline	Repair or replace
Unstable travel	Adjustment required for track	Adjust the track sag
	Damage of idler, track roller or carrier roller	Contact with the assigned dealer of XCMG.
	Bend of chassis frame	Contact with the assigned dealer of XCMG.
	Seizure of stone block or soil in the chassis frame	Remove and repair.
	Unreleased of moving brake	Contact with the assigned dealer of XCMG.
Rotation deactivates	Trouble of rotary motor	Contact with the assigned dealer of XCMG.
	Trouble of pilot valve	Contact with the assigned dealer of XCMG.

Unsmooth rotation	Trouble of rotary gear	Contact with the assigned dealer of XCMG.
	Trouble of rotary bearing	Contact with the assigned dealer of XCMG.
	Lack of grease	Add in the grease.

Periodic replacement parts

Parts replaced at regular intervals		Replacement interval	
Engine	Fuel hose (from fuel tank to filter)	Every two years	
	Fuel hose (from fuel tank to injection pump)	Every two years	
	Oil filter hose (from engine to oil filter)	Every two years	
Hydraulic system	Basic body	Oil pump inlet hose	Every two years
		Oil pump outlet hose	Every two years
		Hydraulic hose of rotation gear	Every two years
	Accessories of equipment	Hose of boom hydraulic cylinder pipeline	Every two years
		Hose of arm hydraulic cylinder pipeline	Every two years
		Hose of bucket hydraulic cylinder pipeline	Every two years
		Hose of pilot pipeline	Every two years

8 Transport, Storage and Protection

 Caution!	<p>During the attachment of machine to the platform of truck or trailer, or removal of machine from them, be sure to follow the local laws and regulations.</p>
Notice!	<ul style="list-style-type: none"> – Provide the appropriate truck or trailer for the convenience of machine transport. Cautions of machine removal – Choose the firm or flat ground. – Be sure to adopt the platform or slope. – During the removal of machine from trailer, there must be a signalman. – Choose the slow-speed mode with a travel mode toggle to avoid high-speed.
 Caution!	<p>The steering on the slope is very dangerous and avoids the steering when going up or down the slope.</p>
Notice!	<ul style="list-style-type: none"> – If the steering is required, transport the machine back to the ground or trailer platform, and drive it on the slope after rectifying the direction. .
	<ul style="list-style-type: none"> – In case of driving up or down the slope, don't use any other operating lever other than the traction operating lever. – The intersection of slope top and trailer platform is convex, and drive the machine by this intersection. – Avoid the possible injuries caused by the turnover of machine during the rotation of upper car. – Keep the arm retracted down and rotate the upper structure slowly to achieve the optimum stability. – Fix the frame of machine with a chain or rope. – Be careful not to touch the dozer when getting on/off the vehicle or unloading the cargo. – Attention when loading/unloading machines with rubber crawlers or parts of rubber crawler, skid should be avoided during operating as these crawlers are relatively flat. Loading/unloading operation must be carried out after the crawlers are cleaned up, especially when there is clay on them.
 Caution!	<ul style="list-style-type: none"> – Do not use sloping plate with inclination over 15° during loading /unloading
	<ul style="list-style-type: none"> – In case that air gets into the oil suction pipe and blocks the cycle of machine oil, and result in engine's abnormal wearing out and improper working. – It's also prohibited to use the dozer to support the machine to get on/off the truck.
 Caution!	<ul style="list-style-type: none"> – It's very dangerous to swing on the sloping plate when loading /unloading vehicles, and it must be avoided!
	<ul style="list-style-type: none"> – If the rotation is necessary, it must be performed after returning to the ground or on the platform of the truck, go through the sloping plate until the direction is adjusted! – There is a heave on the joint of the sloping plate and the truck, please drive with extra care. – When swinging on the trailer platform, pay extra attention to prevent a roll-over.

8.1 Road transport

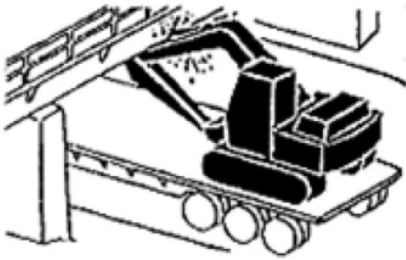
Notice!**– Road transport**

- During the transport of machine on the road, learn of and follow all the local laws and regulations.
- During the transport of trailer, verify the length, width, height and weight of trailer for loading the machine.
- Note: the transport weight and size may be different due to the type installed track plate or front equipment.
- Observe the conditions of transport route in advance, e.g. size, weight limit and traffic regulations. In case of disassembling the machine, meet the local specified size or weight limit.

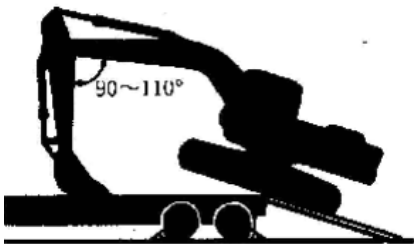
Notice!**Removal of trailer**

- Remove the machine always on firm and flat ground.
- Note: be sure to use the platform or slope during the loading and unloading.
- Adopt the slope or platform.
- Clean the slope or platform and trailer platform thoroughly before loading and unloading, the risk of slipping may exist on them with oil dirt, soil or ice.
- During the use of slope or platform, place the damp block under the wheel of front body and trailer.
- The slope or platform must have enough width, length and strength to make the inclination angle of slope or the gradient of platform below 15°.

8.2 Loading

Notice!

Loading

- The direction of machine is down: with front-end equipment: move the equipment forward with it placed on front body; without front-end equipment: travel in reverse direction as shown in above figure.
- The centerline of machine shall be on the centerline of trailer.
- Drive the machine slowly on the slope.

With front-end equipment:

- Support the plane bucket on the trailer, and the angle between bucket rod and movable arm should be within 90° to 110°.
- Upon inclining the machine to trailer platform, support the bucket to the trailer, move the machine slowly forward, until the whole track moves on the trailer and contacts the platform.
- Lift the bucket slightly, retract the bucket rod and make it under the machine, and rotate the upper structure slowly by 180°.
- Lower the bucket to sleeper.
- Stop the engine, and remove the key from key switch.
- Move the operating lever several times until the whole pressure of hydraulic cylinder is released.
- Pull the safety locking rod to LOCK (lock).
- Close the window, skylight and door of cab, and cover the air outlet to prevent the wind and rain from entering.

In the cold weather, be sure to heat the machine before loading/ unloading it.

8.3 Transport

Notice!

Transport

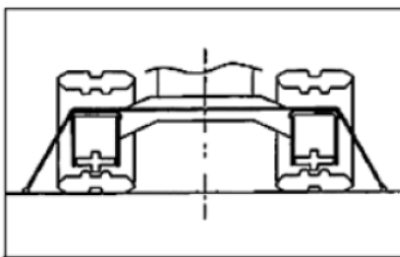

- **Prior to the transportation - tie the chain or rope to the frame of machine, and don't make the chain or rope pass through or pressed on the hydraulic pipe or hose.**
- **Place the damp blocks before and behind the track to fix the machine.**
- **Fix four corners of machine and front-end equipment to the trailer with a chain or rope.**

8.4 Unloading

Notice!

- Unloading make the intersection of trailer platform rear end and slope convex, and drive the machine by it carefully.
- Important: avoid any possible damage of front-end equipment. During the unloading, keep the angle between the arm and boom within 90° to 110° always, retract the arm, and any unloading may cause the damages to machine.

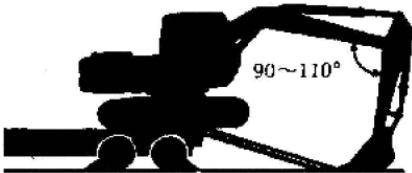

- Upon moving the tail end of machine through the trailer to the slope or platform, support the bucket plane on the ground, and make the angle between arm and boom within 90° to 110° .
- Important: avoid any possible damage of hydraulic cylinder, and avoid any fierce collision of bucket to the ground.
- Place the bucket on the ground before the machine starts to incline forward. During the forward movement of machine, lift the boom and stretch the arm until the machine is fully under the slope or platform.

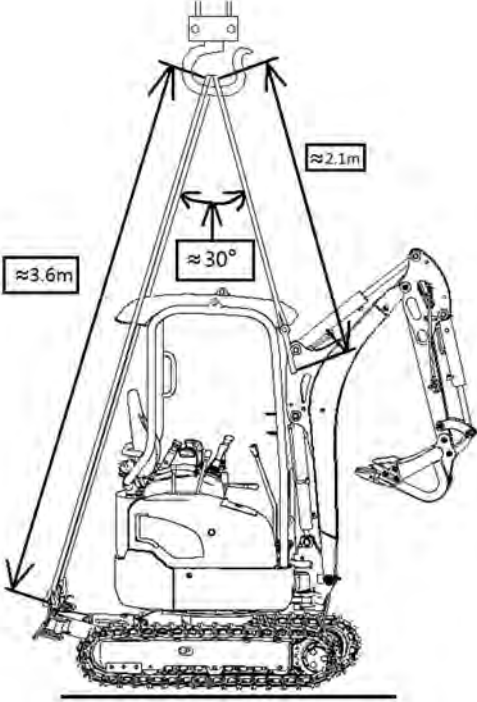

8.5 Lifting the Machine

	Caution!	<ul style="list-style-type: none"> – Lifting steel ropes and other lifting tools may be broken, which results in the serious personal injuries. Don't use any damaged or aged steel rope or lifting tool. 	
			<ul style="list-style-type: none"> – For correct lifting methods, types or sizes of lifting steel cables and lifting tools, contact with the assigned dealer. – Pull the safety locking rod to LOCK (lock), and avoid any unexpected movement of machine during the lifting. – Incorrect lifting methods and incorrect mounting of steel rope will cause the movement of machine during the lifting, which results in machine damages and personal injuries. – Don't lift the machine rapidly, otherwise the lifting steel ropes and lifting tools will be overloaded and may lead to their fracture. – Don't let any person approachable to the lifted machine or drive under it. – The gravity center marked on the machine is for the machine of standard specifications, but the actual gravity center will be changed as per the type of installed accessory or chosen device and their position. Therefore, ensure the balance of machine can't be lost in case of lifting the machine.
			<ul style="list-style-type: none"> – When lifting the machine body, please operate according to the following main points. – Rotate the upper rotating body, and make sure dozer blade forms an angle of 180 degrees oppositely with working device. – Lift the dozer blade to the highest position. – Lift the boom and pull the bucket and arm to the most extent, and then place the locking lever of joystick on "lock" position. – Make the swing pedal on the neutral position without swinging the boom, then cover the pedal and stop the engine. – Install the rings on the holes at the both sides of dozer blade, hang the steel wire and meanwhile hang the steel wire on the boom position as the picture has shown. – Maintain the lifting angle of steel wire as 30 degrees and the length of steel wire is shown as the right figure. –

8.6 Storage and Protection

Notice!	Daily and short-term storage and protection
----------------	--

- Check the machine, repair the worn and damaged parts. If necessary, attach new parts.
- Clean the air filter element.
- If possible, retract all the hydraulic cylinders; if impossible, apply the grease to the exposed rod of hydraulic cylinder.
- Lubricate all the lubrication points.
- Place the track on the long and stable damp block.
- Clean the machine.
- After charging the battery up, remove the battery and store it at dry and safe place. If not, separate the connection of battery negative-pole cable on the wiring terminal (-).
- Add the anti-rust agent into engine coolant. In winter, adopt the anti-freezing agent or drain the coolant off. If the cooling system is emptied, be sure to hang a nameplate “No Water of Radiator” in conspicuous position.
- Loosen the belts of AC generator and cooling fan.
- Apply the paint to desired positions to avoid rusting.
- Store the machine at dry and safe place. In case of storing it outdoor, adopt the water shield.

Notice!

Long-term storage and protection

Storage place

- Commonly store in the ventilated and dry warehouse.
- If the device is stored in open air, park it on the concrete ground easy to drain the water, cover and fix the canvas or hood, and store it at the place that can't be invaded by natural disaster and without corrosive or harmful substance or gas.

Storage

- Use the hydraulic functions of moving, rotation and digging twice to three times every month to lubricate all the parts. Check the level of coolant and lubrication state before the operation.
- Check the appearance quality, protection side and anti-corrosion substances, and etc at regular intervals.

8.7 Use preparation after storage

Notice!

Use preparation after storage

- Remove the coverings.
- Remove the protective substances painted on the exposed part.
- Charge the battery, mount or connect it.
- After draining the oil of engine crankcase, renew the oil.
- After draining the gear oil in the rotary and traction reducer, renew the gear oil.
- Drain the inclusions and mixed water out of the hydraulic oil tank and fuel tank.
- Apply the grease to each hinged position.
- Fill in the coolant as per the specification.
- For the check before the operation, refer to the relevant regulations of operation.

9 Lift Capacity Calculation of the Excavator

9.1 Brief introduction and choosing the lift working condition:

Notice!

- Brief introduction: knowing from the calculation, the excavator force bearing badly when it's under the digging condition, so this calculation will not calculate the lift load determined by the assembly intensity of the working device, swing platform and the bracket.
- Choosing the working condition:
- In this calculation, the lift point is at the bucket pivot mounting pin on the arm, the maximum lift weight not including the bucket weight.
 - o Under the still load tipping limit condition, the rated lift load is 75% of the maximum load;
 - o Under the hydraulic limit condition, the rated lift load is 87% of the maximum load;
- Lift scope figure of excavator is shown as the following Figure1:

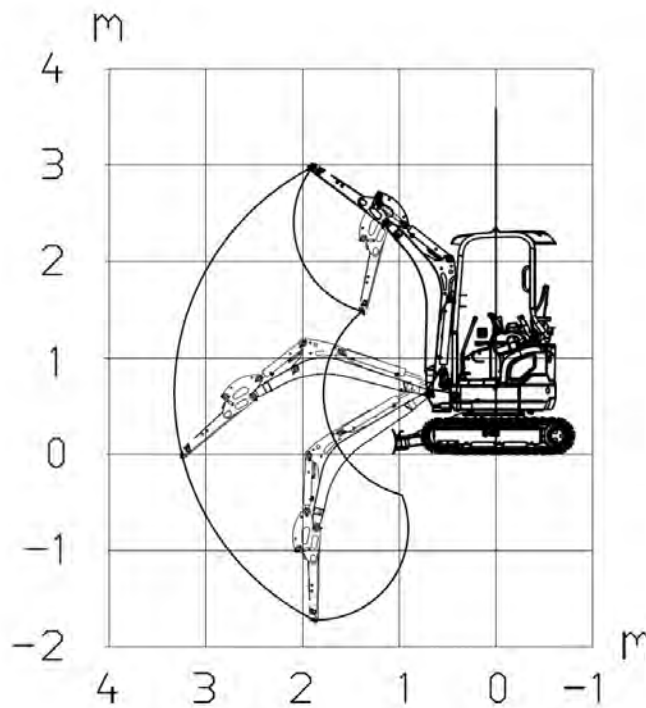

Figure 1

Notice!

As well as the lifting conditions, the length of the arm also affects the permitted lifting capacities and the stability of the machine. Compare the dimensions of the machine arm with the details given in the lifting capacity tables, in order to use the correct lifting capacity table for your machine.

9.2 Lifting attachment

Notice!

- The lifting operation is only permitted when the excavator is equipped with the following safety systems as per EN474-5:
 - Pipe safety valve on the boom cylinder
 - Pipe safety valve on the arm cylinder
 - Overload warning system
- If the dozer is being used to increase the machine's stability, an additional pipe safety valve must be installed in accordance with EN 474-1.
- The overload warning system of the lifting operation is optional. If the machine is used for lifting, please contact your XCMG dealer, and confirm whether the system has been installed. If not, it is forbidden to use it for lifting. Otherwise, any accident occurred has no responsibility with XCMG.

Notice!

- The lifting attachment is to be fastened to the attachment or to other parts of the excavator in such a manner as to exclude the possibility of the lifting rope accidentally unhooking.
- The installation on the attachment or the equipment must be such as to guarantee the optimum field of vision between the operator and the guide[the person who fastens the lifting rope to the lifting attachment].
- The lifting attachment is to be positioned so that the lifting rope is not deflected from its vertical direction of tension by other parts of the machine.
- The lifting attachment must be formed and positioned in such a manner as to exclude the possibility of the lifting rope accidentally slipping.
- Care must be taken when positioning the lifting attachment that is no risk of restriction during normal operation of the excavator or when working on any particular object.
- Load suspensions may only be welded on by suitably skilled personnel. For this type work, please contact your XCMG dealer.
- At every point of the attachment or the boom, the lifting attachment must withstand a load of two-and-a-half times its rated load.

9.3 Load suspension device

Notice!

- A load suspension device with all the characteristics listed below is required.
- The system must withstand a load two-and-a-half times its rated lifting load, regardless of the point at which that load is applied.
- The system must be designed in such a way as to practically prevent any objects that have been lifted from falling from the lifting attachment, for example by means of a protective attachment designed for this purpose.
- The system must not allow the lifting attachment to slip from the attachment being lifted.
- Do not lift loads that exceed the values indicated in the lifting capacity tables.
- Always observe the maximum permissible lifting capacity of the hoisting gear. Lifting loads over the maximum permissible lifting capacity is not allowed.
- The values indicated in the tables only apply to level and hard grounds. When working on soft ground, the machine can tip over easily, as the load is concentrated on one side only and the crawler or the dozer can dig into the ground.
- The values indicated in the tables only apply for loads without a bucket. If a bucket is used, the weight of the bucket must be subtracted from the values in the tables. The weight of mounted accessories must be subtracted from the lifting capacity.
- During lifting operations, the boom may not be swiveled to the left or right. The machine could tilt. In order to avoid inadvertent actuation, lower the locking flop for the boom swing pedal.
- During lifting operation, driving/moving the crawler chassis is not permitted.
- Use utmost care to avoid any risk of tipping, slipping, or other potential risks implied when lifting loads.
- The operator must pick up the load at the centre, avoid sudden movements, and make sure the load does not swing.

9.4 Calculation model and known specification

Notice!

1) Calculation model

- In this calculation, the excavator **should be parked on firm and level ground.**
To calculate the lift capacity of the 2 states:
 - o the rated lift capacity at straight ahead the excavator, shown as the Figure2
 - o the rated lift capacity at positive side of the excavator, shown as the Figure3

2) Lift capacity determined by stability

- The calculation of lift capacity at the straight ahead
- When lifting at the straight ahead the excavator, the tipping point is located over the edge at the front outrigger, see the Figure 2:

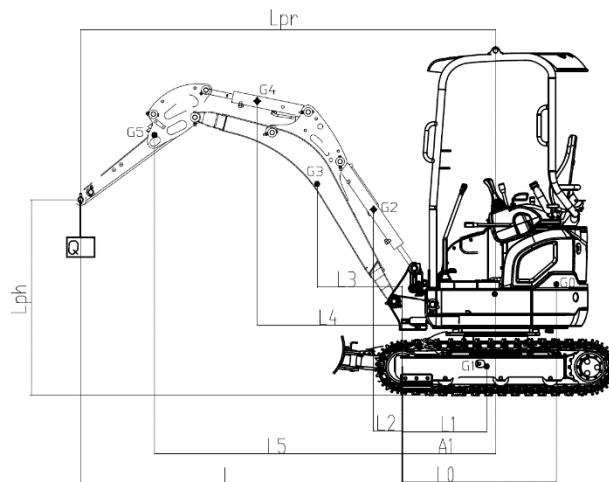

Figure 2

3) Calculation of the lift capacity at the over-side

- When lifting at the over-side of the excavator, the tipping point is located at the middle line of the outrigger, see the Figure 3:

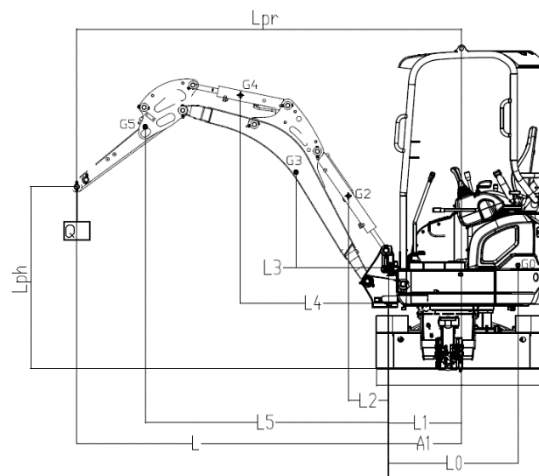

Figure 3

9.5 Table of lift capacity

Table of lift capacity (0.95m arm)						
Do not attempt to lift or hold any load that exceeds rated load capacity at the specified lift radius and height. The lift point is located at the lifting eye of the arm.						
Lph (m/ft)	Rated lift capacity – Straight ahead (back) (kg/lb)					Lift capacity at maximum radius
	Lpr (m/ft)					
	1/3.3	2/6.6	3/9.8			
2/6.6		*296.2/653				313.2/690.5
1/3.3		536.2/1182.1	296.7/654.1			258.3/569.5
Ground		500.6/1103.6	285.8/630			256.8/566.1
-1/-3.3	*970.1/2138.7	497.3/1096.4				316.9/698.6
Capacities marked with an asterisk(*) are limited by hydraulic capacities.						
Lph (m/ft)	Rated lift capacity – over-side (kg/lb)					Lift capacity at maximum radius
	Lpr (m/ft)					
	1/3.3	2/6.6	3/9.8			
2/6.6		*296.2/653				256.8/566.1
1/3.3		427.8/943.1	242.3/534.2			211.2/465.6
Ground		394.7/870.2	231.7/510.8			208.9/460.5
-1/-3.3	*970.1/2138.7	391.6/863.3				255.6/563.5
Capacities marked with an asterisk (*) are limited by hydraulic capacities.						
The weight of slings and any auxiliary lifting device must be deducted from the rated lift capacity to determine allowable net lifting load. Lift capacities are based on the machine standing on a firm, uniform level ground. The user shall consider the job conditions such as soft or uneven ground. Before operating the machine, the operator should be fully acquainted with the operator's manual and the operating safety manual provided by the manufacturer.						
NOTE 1 Lift capacities are indicated without the interventional thrust from the outside.						
NOTE 2 The lift capacities shown in this table do not exceed 75% of minimum tipping loads or 87% of hydraulic capacities.						
NOTE 3 The critical stable position is at the over-side.						
NOTE 4 Lift capacities only apply to the machine that originally manufactured and normally equipped by the manufacturer.						
NOTE 5 The total mass of the machine is 1795kg. Included 1.828m booms, 0.95m arm, 192kg counterweight, 40kg bucket, all operating fluids and a 75 kg operator.						
NOTE 6 Lift capacities are in compliance with ISO 10567:2007.						

Table of lift capacity (1.12m arm)

Do not attempt to lift or hold any load that exceeds rated load capacity at the specified lift radius and height. The lift point is located at the lifting eye of the arm.

Lph (m/ft)	Rated lift capacity – Straight ahead (back) (kg/lb)					Lift capacity at maximum radius
	Lpr (m/ft)					
	1/3.3	2/6.6	3/9.8			
3/9.8						*290.9/641.3
2/6.6			*299.9/661.2			*299.7/660.7
1/3.3		*508.4/1120.8	*329.1/725.5			*280.4/618.2
Ground		*586.1/1292.1	*327.6/722.2			*261.7/576.9
-1/-3.3	*905.4/1996.0	*450.1/992.3				*248.1/546.9

Capacities marked with an asterisk(*) are limited by hydraulic capacities.

Lph (m/ft)	Rated lift capacity – over-side (kg/lb)					Lift capacity at maximum radius
	Lpr (m/ft)					
	1/3.3	2/6.6	3/9.8			
3/9.8						*290.9/641.3
2/6.6			246.5/543.4			230.5/508.2
1/3.3		424.1/934.9	237.6/523.8			192.7/424.8
Ground		386.5/849.9	225.5/497.1			190.5/419.9
-1/-3.3	*905.4/1996.0	380.7/839.3				228/502.6

Capacities marked with an asterisk (*) are limited by hydraulic capacities.

The weight of slings and any auxiliary lifting device must be deducted from the rated lift capacity to determine allowable net lifting load. Lift capacities are based on the machine standing on a firm, uniform level ground. The user shall consider the job conditions such as soft or uneven ground. Before operating the machine, the operator should be fully acquainted with the operator's manual and the operating safety manual provided by the manufacturer.

NOTE 1 Lift capacities are indicated without the interventional thrust from the outside.

NOTE 2 The lift capacities shown in this table do not exceed 75% of minimum tipping loads or 87% of hydraulic capacities.

NOTE 3 The critical stable position is at the over-side.

NOTE 4 Lift capacities only apply to the machine that originally manufactured and normally equipped by the manufacturer.

NOTE 5 The total mass of the machine is 1795kg. Included 1.828m booms, 1.12m arm, 192kg counterweight, 40kg bucket, all operating fluids and a 75 kg operator.

NOTE 6 Lift capacities are in compliance with ISO 10567:2007.

10 Cleaning

10.1 Cleaning the system

Notice!

Property damage due to sharp water jet!
Do not hold the water jet of the high-pressure cleaner directly on the seals.

Notice!

Damage due to cleaning agents!

- Do not use harsh detergents on plastic surfaces.

➔ Clean system with high-pressure cleaner or water hose.

11 Warranty

Warning!

In the event of personal injury or material damage, the manufacturer is liable only for proven defects in the system.

- The warranty expires in the following cases:
- In case of improper or unintended use as defined in this user's manual
- In case of improper operation
- In case of insufficient care and maintenance
- When using improper spare parts
- For unallowed or unapproved technical changes
- Any change or modification must be agreed in written with the manufacturer.
- Be stolen

Danger!

indicates an immediate danger that may cause death or serious injuries if it is not avoided

Warning!

indicates a possible dangerous situation that may cause death or serious injuries if it is not avoided.

Caution!

indicates a possible dangerous situation that may cause moderate or light injuries if it is not avoided.

Notice!

indicates a possible dangerous situation that may cause property or environmental damage if it is not avoided.

12 Decommissioning and disposal

Decommissioning and disposal guidelines

12.1 Properly disassemble the unit

 Warning!	Improper disassembly can cause an increased danger of accident. <ul style="list-style-type: none">– Contact your XCMG partner for proper disassembly of the unit.– Disassemble the unit into single parts according to the instructions of your XCMG partner.
---	--

12.2 Disposal.

 Warning!	Clean all oily and greasy parts before disposal. Oil and grease must not be released into environment. Comply with the locally applicable laws when disposing of the unit's single parts and consumables. <ul style="list-style-type: none">– Clean all oily and greasy parts.– Dispose of the components according to their nature (steel, plastic, electric and electronic parts, and etc.).– Dispose of all consumables-even biodegradable ones-in an environmentally friendly way.– Contact your XCMG partner regarding the purchase of a new unit.
---	---

Copyright © 2019 XUZHOU XCMG EXCAVATOR MACHINERY CO., LTD.

Printed in China

All rights reserved, in particular the global copyright laws, right of reproduction and right of distribution.

No part of this publication may be reproduced, translated or used in any form or by any means – graphic, electronic or mechanical including photocopying, recording, taping or information storage or retrieval systems – without prior permission in writing from the manufacturer.

No reproduction or translation of this publication, in whole or part, without the written consent of XUZHOU XCMG EXCAVATOR MACHINERY CO., LTD.

Any violation of the legal provisions, in particular those relating to copyright protection, will lead to both civil and criminal prosecution.

XUZHOU XCMG EXCAVATOR MACHINERY CO., LTD. keeps abreast of the latest technical developments and constantly improves their products.

For this reason, we may from time to time need to make changes to figures and descriptions in this documentation which do not reflect products that have already been delivered and that will not be attached on these machines.

Technical data, dimensions and weights are only given as an indication. Responsibility for errors or omissions is not accepted. Non-metric weights and measurements are approximate. Translation of original Operation and Maintenance Manual.

The cover features the machine with possible optional equipment.

Photographs and graphics are symbolic representations and may differ from the actual products.

The Operation and Maintenance Manual and any amendments to it must be constantly available at the place of use of the vehicle. Possible amendments are included at the end of the Operation and Maintenance Manual.



XUZHOU XCMG EXCAVATOR MACHINERY CO., LTD.

Add: No.39 Gaoxin Road Economy Technology Development Zone Xuzhou, Jiangsu, P.R.China

Tel: +4921518209351

Fax: +4921518209359

Service hotline: 4001109999

Post Code: 221004

Website: <http://www.xcmg.com>

All rights reserved. Violators will surely be prosecuted.

All rights reserved. Violators will surely be prosecuted.



XUZHOU XCMG EXCAVATOR MACHINERY CO., LTD.

Add: No.39 Gaoxin Road Economy Technology Development Zone Xuzhou, Jiangsu, P.R.China

Tel: +86 (0) 516 8311 1838

Fax: +86 (0) 516 8311 1896

Service hotline: 4001109999

Post Code: 221004

Website: <http://www.xcmg.com>

XCMG European Sales & Services GmbH

Add: Europark Fichtenhain B 4, 47807 Krefeld, Deutschland

Tel: +49 (0) 21 51-82-09-351

Fax: +49 (0) 21 51-82-09-359

E-mail: Europe@xcmg.com