

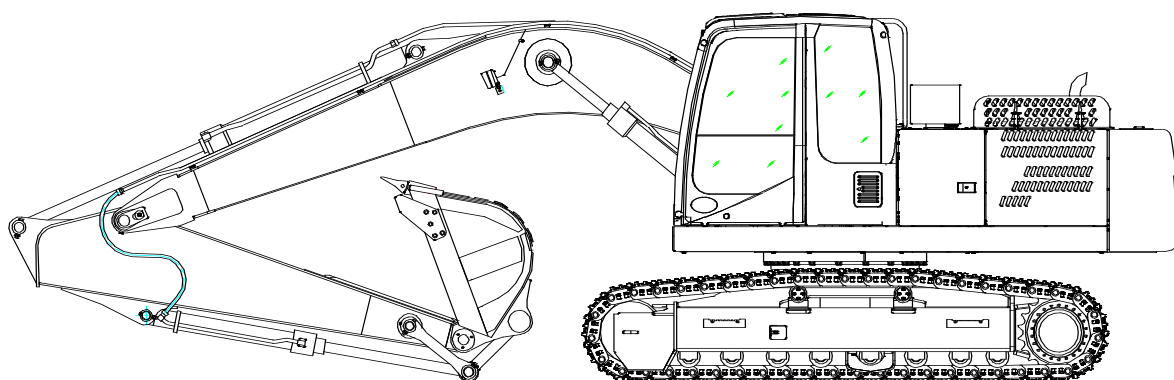

## **XE210C Hydraulic Excavator**

# **Operating & Maintenance Manual**



**XUZHOU XUGONG EXCAVATOR  
MACHINERY CO., LTD.**

## Preface

Welcome you to use our XE210C hydraulic excavators.

Before operating, maintaining and repairing these equipments, please read carefully and master this manual, and learn how to correctly operate, maintain and repair your machines while paying more attention to related safety warning. Otherwise, there will be the injury on person and damage on machines.

A standard machine is applicable in the working temperature between - 15°C~ 40°C, the altitude is below 2,000 meters.

If you need to use in other conditions except the above one, or modify the machine, please contact with our company for confirmation.

This manual is the major component of the equipment, which provides the operator with necessary information on safety, operation and maintenance. It can also help the operator use and maintain purchased Xugong equipment properly and safely. While selling the machine, this manual is sure to be attached.

Before operating, maintaining and repairing these equipments, make sure to read carefully and have a good command of what is in this book, especially those safety-concerned regulations, and try to operate according to the requirement.

The following content is included in this book:

- operation;
- lubrication, maintenance and repair;
- transportation, storage and protection;
- specification of technology

**We may change something any time about all the materials, the charts and tables and the specifications in this manual before publishing without informing you.**

**Machine Number:**

Please record all numbers correctly for future maintenance. In addition, your distributors also need this information. If this manual is on the machine, please put the part of the machine numbers in the safe places except the machine for filing in order to search the machine after missing.

The numbers listed in this group are the unique identification numbers (serial numbers) for each machine and the hydraulic parts; please fill these identification numbers in the corresponding places for quick putting forward when required.

Machine

Type: \_\_\_\_\_

Number of the complete machine



Engine

Type: \_\_\_\_\_

Manufacturing No.: \_\_\_\_\_

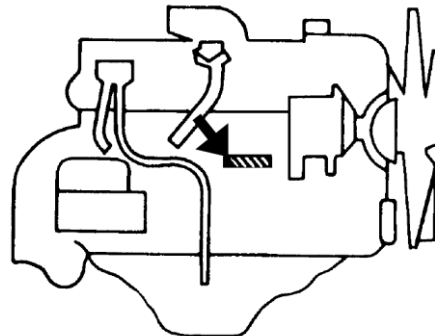

Bucket

No.: \_\_\_\_\_

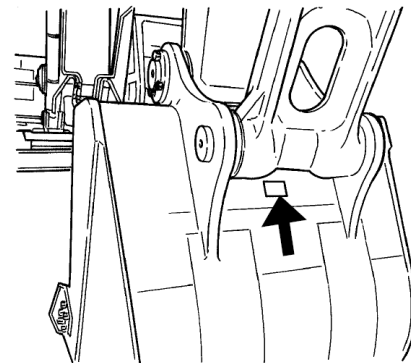

Travel motor

No.: \_\_\_\_\_

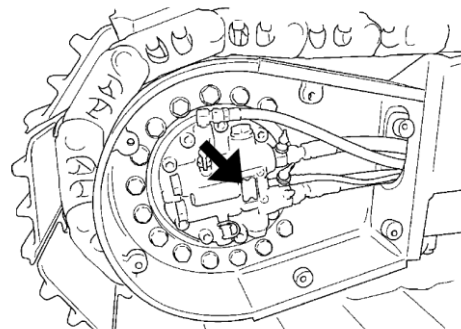

Swing motor

No.: \_\_\_\_\_

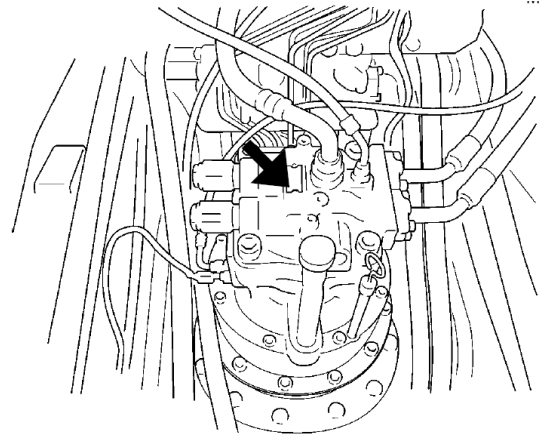

Hydraulic pump

No.: \_\_\_\_\_

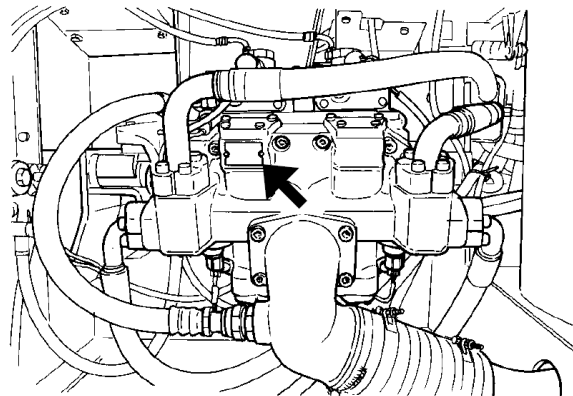

## Content

Preface	
Machine Number	
Safety	
<b>Instruction of safety and warning signs</b>	7
Safety sign and other signs	9
Location of safety signs	9
<b>Instruction of safety signs</b>	10
Safety rules	17
Safety equipment	18
<b>Safe operation of machine</b>	26
Start the engine	26
Operation	27
Transportation	34
Battery	35
Traction	37
Lifting objects by the bucket	38
Optional components	39
Safety maintenance instructions	42
Name of parts	
General drawing	48
Cab	49
Monitor	52
Displaying interface of main screen	54
Control panel of air conditioner	60
Radio	61
Seat	62
Switches	63
Operation general principle	65
Operating procedure	66
Operating environment	66
The preparation and operation of starting	70
The preparation and operation of starting	73
Operation of running	76
Operation of cutoff	81
Getting on and off the machine	83
Operating procedure	84
Operation under special conditions	93
Filling procedure of fuel, hydraulic oil, lubricant and anti-freeze fluid	93
Safe operating procedure against fire	97
Other operating procedures	100
Lubrication, maintenance and repair	
General principle	105
Lubrication of equipment	106
The Kinds of lubricant	106
Lubrication points	106
Lubrication period	110
Safety points for attention and precautionary measures	111
Maintenance and repair	112
Safety rules	112
Maintenance	116
List of maintenance periods	130
Trouble shooting	131
Periodic replacement of parts	139
Transport, storage and protection	
Transport	140
Caution of transport	140

Road transport .....	141
Removal of trailer .....	141
Storage and protection.....	144
Daily and short-term storage and protection .....	144
Long-term storage .....	144
Use preparation after storage.....	144
Technical specifications	
Product specification.....	145
Operation range.....	146
Hydraulic system schematic.....	147
Appendix	
Crawler type and application.....	148
Bucket type and application .....	149
Hammer-style knapper (Optional) .....	150
Weight of work Load .....	153
Backcover	

## Safety

### Instruction of safety and warning signs



**This is the sign of “ATTENTION ON SAFETY”. When you notice this warning , you should read carefully the following information and abide by it and inform other operators.**

#### Understand the warning remarks on safety warning scutcheon.

On safety sign of this manual and machine, there are “DANGER”, “WARNING” and “CAUTION” separately used along with “ATTENTION ON SAFETY”, indicating 3 levels of danger due to dangerous or unsafe operation. Whenever seeing the triangle sign of safety warning and whatever warning remark is followed, you must read carefully the warning content.



**Danger**—— indicating the case with direct danger. Without avoidance, it will lead to the death or serious injury. It can also warn the explosion or damage on equipment due to improper operation or treatment.



**Warning** —— indicating the latent danger. Without avoidance, it will lead to the bad injury or death. It can also warn and prevent the highly unsafe operation from happening.



**Caution**—— indicating the latent danger. Without avoidance, it will lead to the slight or medium-level injury. It can also be used to remind the prevention from ordinary operating factors when working.

Sometimes some safety signs are also used on this machine; they are not followed with above signal vocabulary.

In this book, “CAUTION” is used for the attention to safety indication.

**Important**——to avoid of the confusion between the indication of machine protection and person safety, “IMPORTANT”-this signal vocabulary, is used to show the case probably leading to the damage on machine.



“Attention”——additional introduction on certain information

Since it is impossible to list all the latent dangers in all working conditions in advance, the safety must be ensured for you and the others and the damage are avoided of if the operation is not recommended. Without approval from our company, any modification made by operator will lead to the danger. So before correcting, you should inquire our company or empowered franchiser. Otherwise, our company will not be responsible for any bad result from unapproved renovation.

Our company will not be responsible for any equipment damage or unsafe running due to the following reasons:

- Carrying out modification on machine without any approval
- The operation does not fit the normal mode
- The equipment failure due to non-original product or unauthorized repair by company or individual
- Beyond the usage range for the equipment

Our company will not compensate for any equipment damage or unsafe running due to the following reasons:

- Improper operation
- Insufficient maintenance
- Using the fuel or lubricant beyond the recommendation

For the continuous improvement of product design and the difference of the customer’s demand on

assignment, it is possible that the content, specification and icons etc. will have some change at any time, which will influence the maintenance and repair of machine. The pictures in the book is only used to describe the concerning part vividly, varying from the practical machine probably.

Our company reserves the rights to modify all materials, drawings and specifications in this manual at anytime without any notice.



### Safety sign and other signs

On many part of this machine, there are safety sign and other signs, so the operator should fully understand the content and location of all signs and abide by the following requirements:

- Maintain the safety signs clear, undamaged and existing; if there is the loss, damage of sign or dim characters or pictures, please repair or replace them timely.
- While the part with safety signs is needed for a replacement, the new one must be ensured to have corresponding signs.
- When cleaning the safety signs, it is proper to use cloth, water and soap solution, other than those tools and detergent which will spoil the signs or any solvent, gasoline and other pungent chemical agent to avoid of the shedding of those signs.
- The assignment of safety signs and other signs is shown as follows:

### Location of safety signs

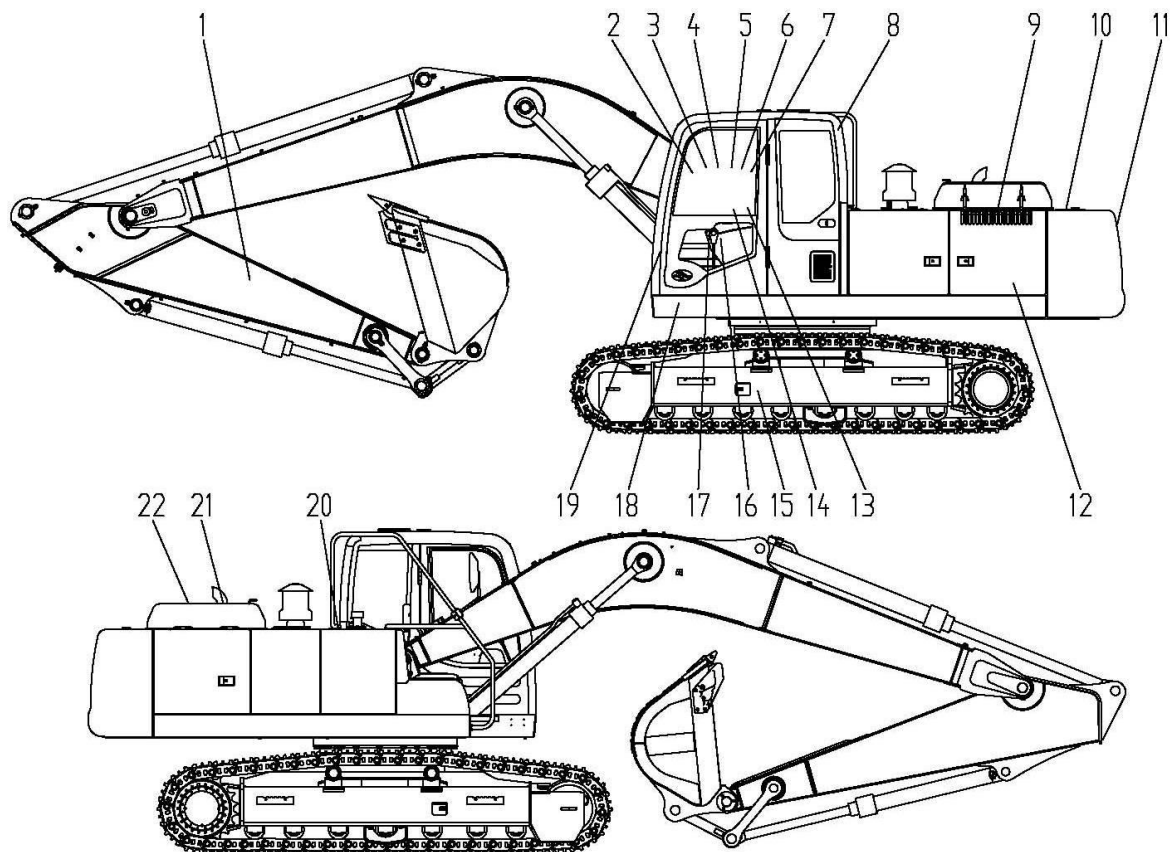

### Instruction of safety signs

- (1) Warning on bucket lever away from operation scope

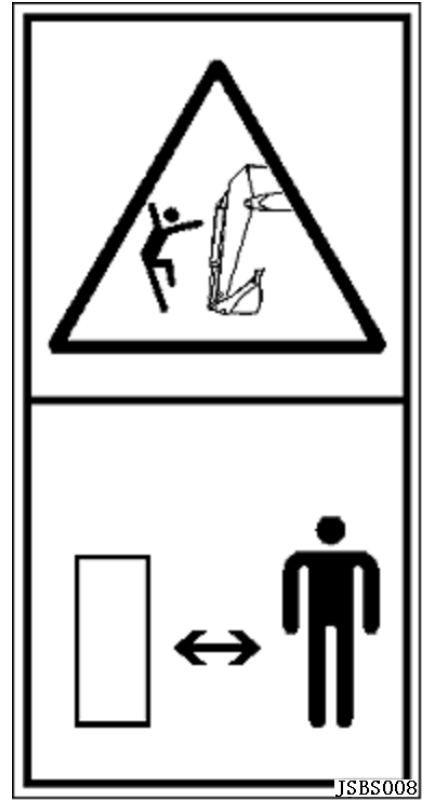

- (2) Picture of lubrication and maintenance

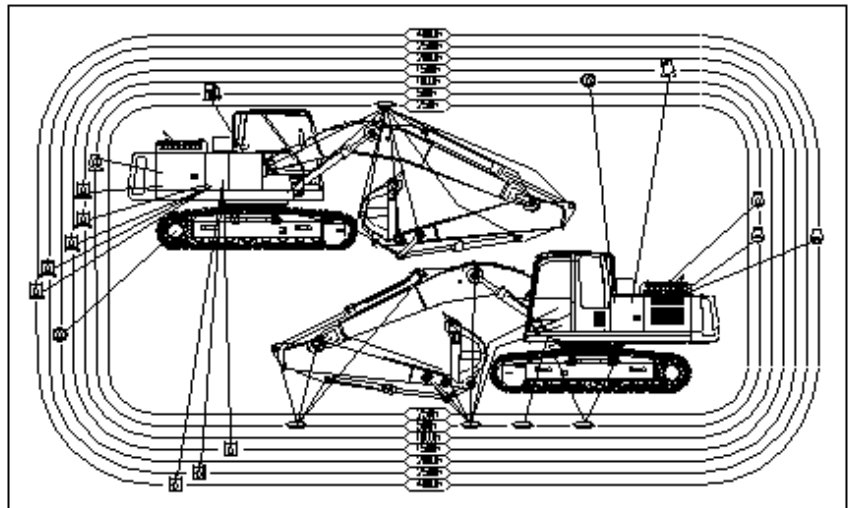

- (3) Operational instruction

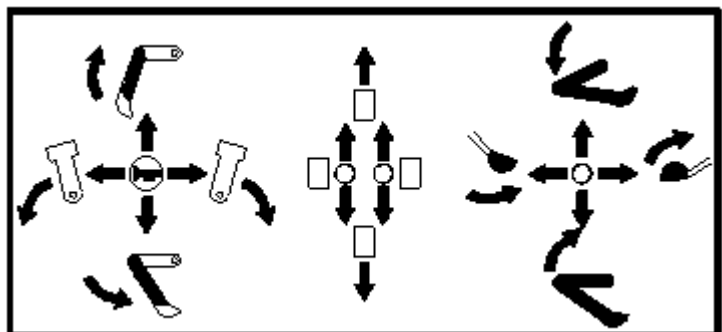

- (4) Warning signs in the manual

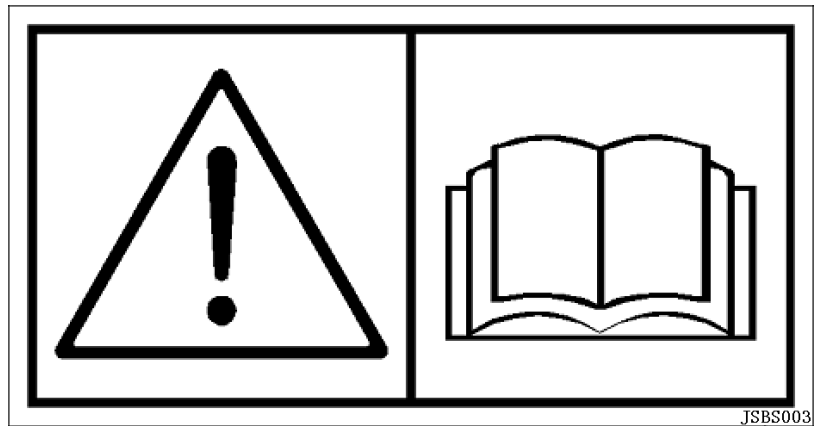

- (5) Sign for being away from the high voltage electricity

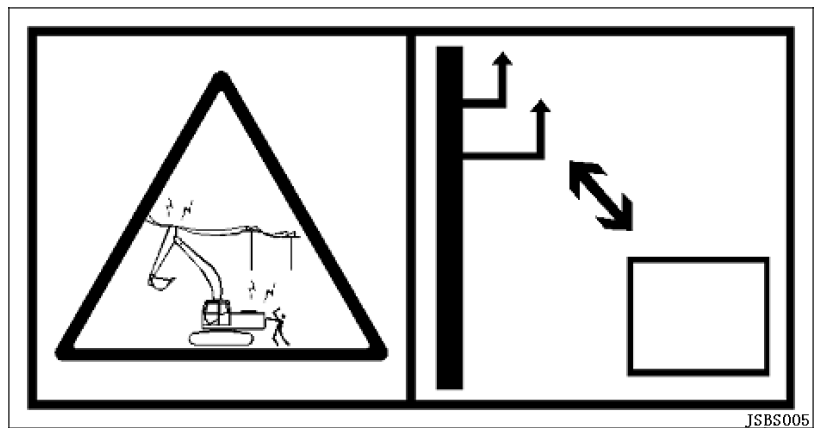

- (6) Sign for locking the doors and windows

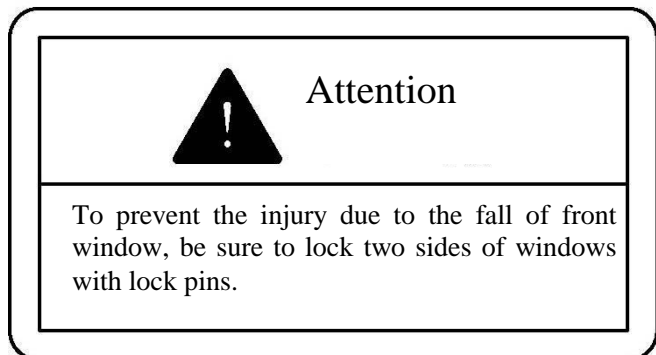

(7) Machine starting sign

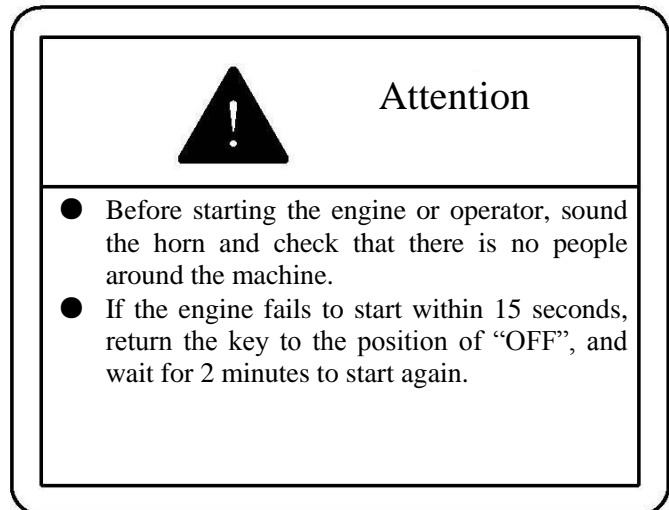

(8) Safety exit sign

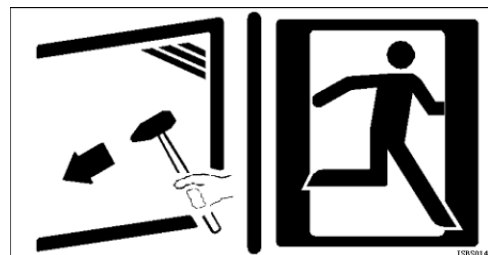

(9) Sign for rotating

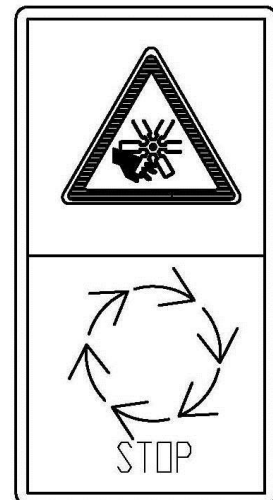

(10) Anti-falling sign



- (11) Sign for being away from the action radius

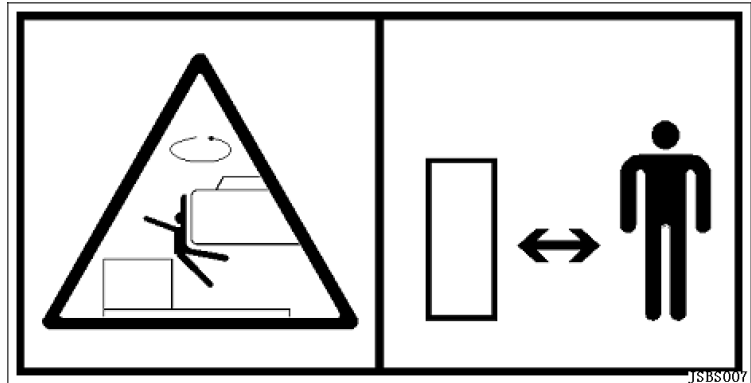

- (12) Battery sign

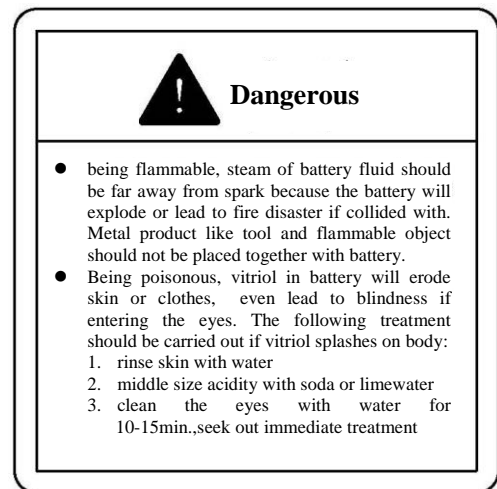

- (13) Sign to prevent the movable arm injury

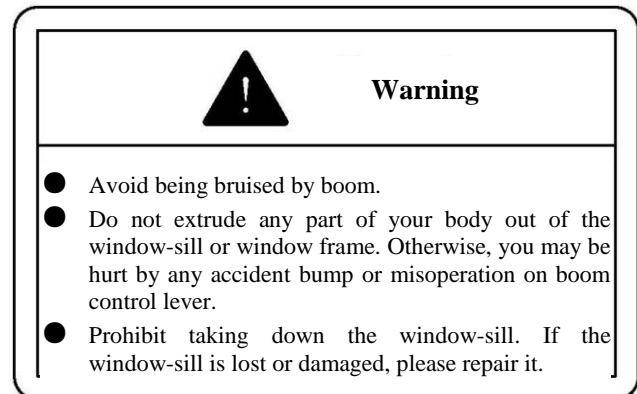

- (14) Sign for the driver' notes

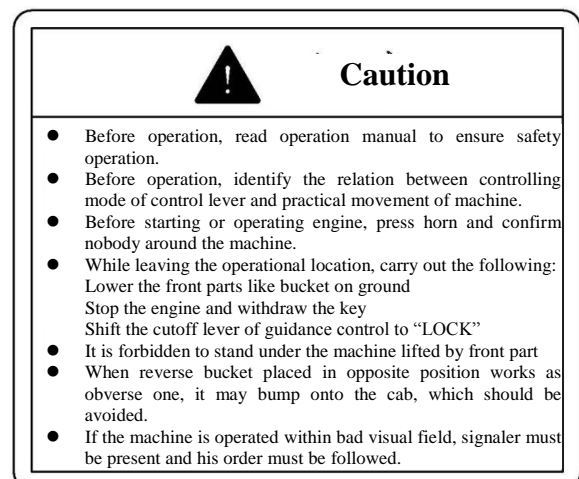

(15) Warning on adjusting the crawler tension

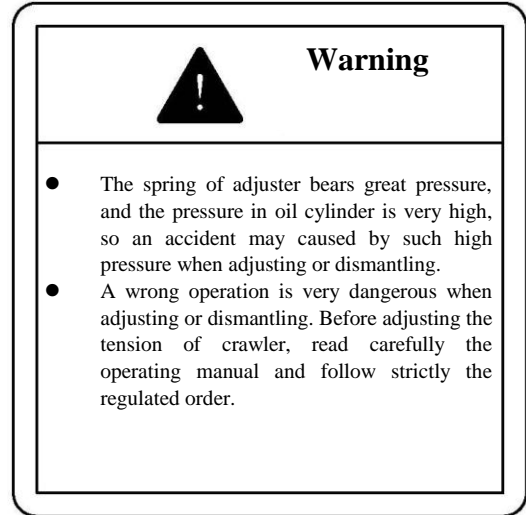

(16) Schematic drawing to start and close the safety handle.

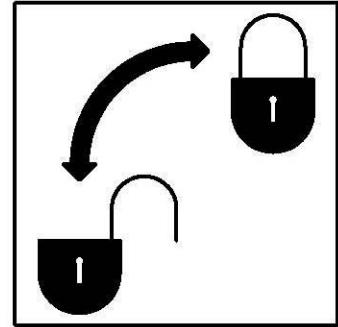

(17) Sign to abandon operation after stoppage

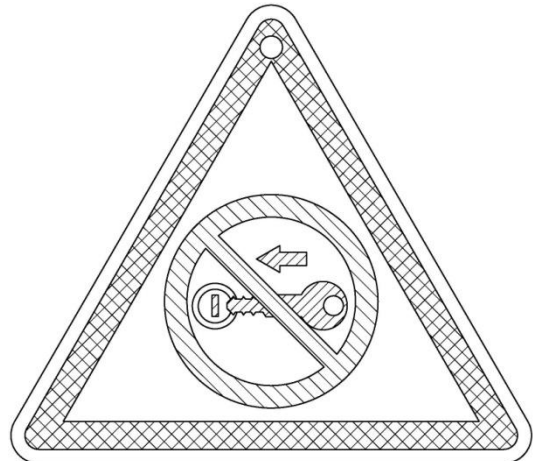

(18) Schematic drawing to lift the complete machine

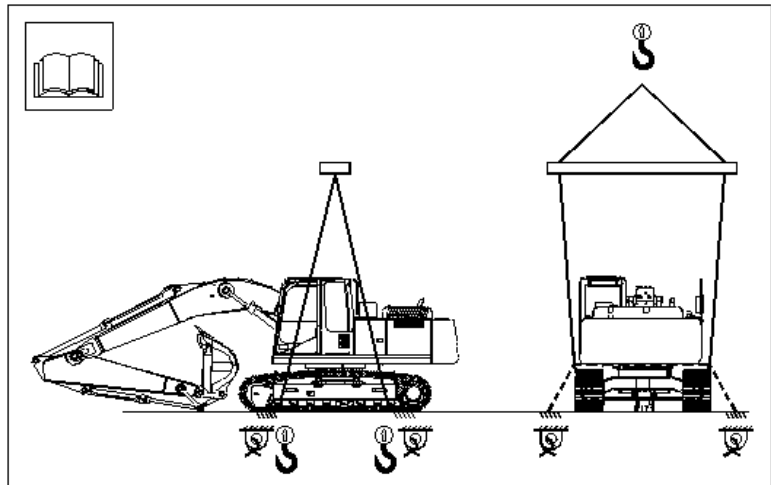

(19) Safety sign for locked machine

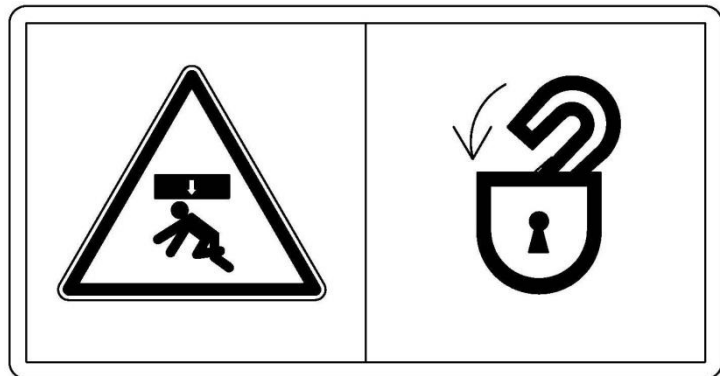

(20) Hydraulic oil sign

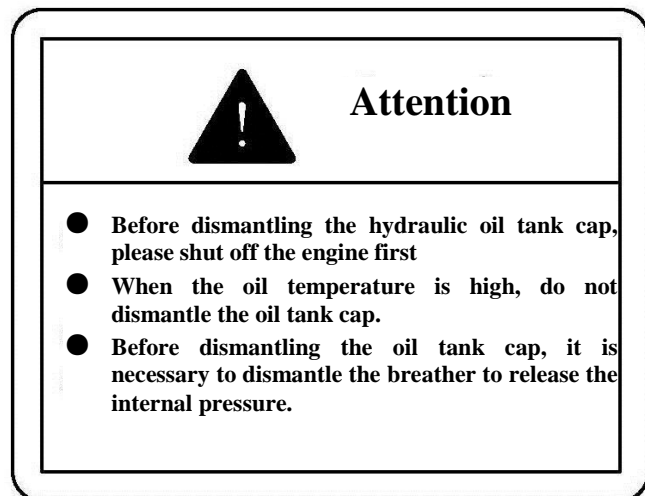

(21) No stepping sign



(22) Sign to prevent scolding the arm





## Safety rules

- Only the personnel trained and guided can operate and maintain the machine.
- When operating and maintaining the machine, obey to all of the safety rules, notes and instructions.
- No operating or repairing the machine after drinking when being sick to avoid injury to yourself or others.
- While working with other operators or site command personnel, be sure to use the gestures that all of them can understand.

## If abnormalities found

If any abnormality (noise, vibration, smell, abnormal display for the instruments, smoke, oil leakage or any abnormal display on the alarming devices and the monitors) is found during operation or maintenance, report to the responsible personnel and take proper measures. Do not operate the machine before removing the faulty.

## Working suit and the protection articles for the operators

- Do not wear loose clothes and jewelries which are dangerous to be caught on the operating levers or other protruding parts.
- If the hair is too long and extends outside the safety helmets, it is dangerous to wind into the machine, so it is necessary to tie the hair before operation.
- Wear the safety helmet and safety shoes always. When operating and maintaining the machine, wear the safety glasses if necessary.
- Check the functions of all of the protection devices for normality.

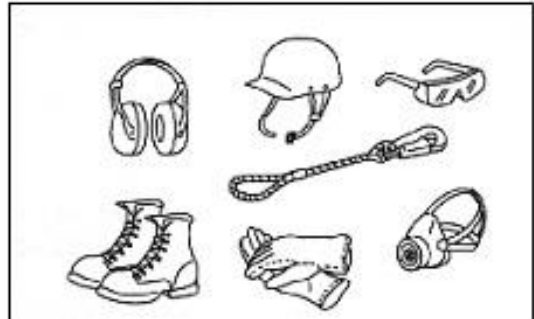

## Fire extinguisher and first-aid kit

In order to possible fire or injuries, attention must be paid to the following items:

- Prepare the fire extinguisher and read the use manual to ensure to know how to use when emergencies.
- Check and maintain regularly to ensure the fire extinguisher in a good condition at anytime.
- Prepare the first-aid kit, check regularly, and add or replace the drugs.

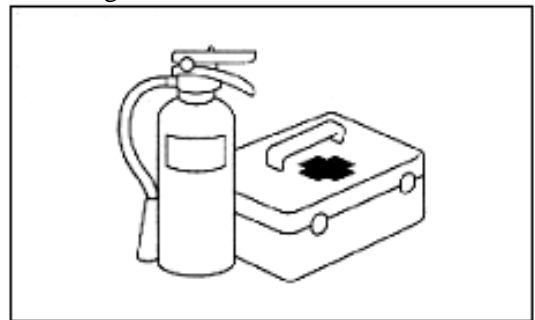

## Safety equipment

- Ensure all shields and cover plates in the proper positions. If any damage for them, please repair immediately.
- Understand the use methods of the safety devices and use them correctly.
- It is prohibited to dismantle any safety devices and keep them in a good working condition.

## Keep the machine clean

- If the water inflows into the electrical system, it will cause the instruments not to work and the machine to be faulty. **It is banned to use the water or steam to flush the electrical system (such as the sensors and connectors, etc.).**
- If the machine brings with mud or oil contamination, it is dangerous to slide over and fall down while checking or maintenance.
- Please keep the machine clean always.

## Keep the driver' cab clean

- Be sure to remove the mud and the oil contamination in the soles before entering the driver' cab. If the mud or oil contamination is adhered on the soles, it is sliding when operating the pedals and possible to result in serious accidents.
- Do not put the parts or tools around the driver' cab.
- Do not stick the plastic sorbent pad to the window glass because its magnifier role may cause fire.
- When driving or operating the machine, do not use wireless telephone in the driver' cab.
- It is banned to bring dangerous goods (such as the flammable and exposable goods) into the driver' cab.

## Leave the operator's chair after locking the working devices

- Before leaving the chair (e.g. when opening or closing the front window or the roof window, dismantling or installing the bottom window and adjusting the chair), lower the working devices down to the ground completely and then shut down the engine to avoid touching the operating lever and make the machine move suddenly to cause serious injury or damage the machine.

- When leaving the machine, be sure to lower the working devices down to the ground completely and then shut down the engine. Lock all equipment, take off the keys and put them in the safe places.

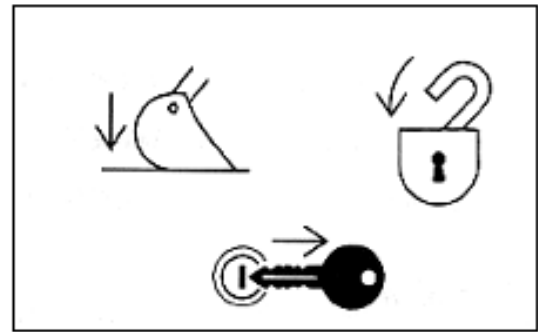

### Handrails and steps

To avoid injury for the personnel climbing up and down the machine, the following requirements must be followed:

- When climbing up and down the machine, use the handrails and steps marked by the triangular arrows in the drawing.

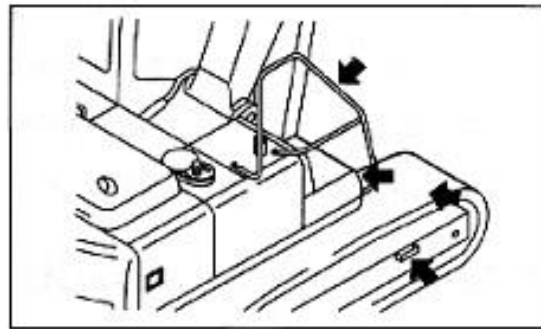
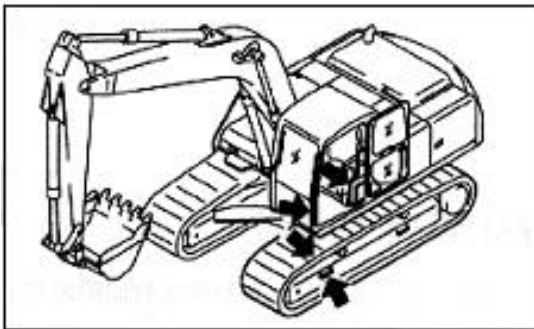

To ensure the safety, face the machine, keep hold at the three points (two feet and one hand or two hands and one foot) tightly, and step on the handrails and steps (including the track shoes) tightly.

- When climbing up and down the machine, do not hold the operating lever, and do not walk on the engine without non-slip mat or cover plate.
- When climbing up and down the machine, check the handrails and steps (including the track shoes) for oil contamination, lubrication grease or mud. If there are these materials there, wipe off immediately.
- It is banned to climb up and down the machine with tools in the hand.



### Installation and dismantlement

- Do not jump up and off the machine.
- Do not climb up and down the machine when the machine is moving.
- If the machine moves suddenly without manual operations, it is banned to jump up the machine and attempt to stop the machine.

### No persons allowed on the accessories

It is banned for any one to sit on the scoop, grab or other accessories, because it is dangerous to fall down or cause serious injury.

### Prevent scolding

#### Hot cooling liquid

- When discharging the cooling liquid, to avoid the hot water or steam spraying and causing burning, before starting to operate, ensure to reduce the temperature of the radiator cap to that can be touched by the hands. When dismantling the radiator cap, loosen the cap slowly to reduce the internal pressure of the radiator.



#### Hot oil

- When checking or discharging the oil, to prevent burning caused by the oil sprayed or touching the hot parts, before operating, be sure to cool the temperature to the degree that the cap or the screw plugs of the oil tank can be touched by hands. Before dismantling the oil tank cap or the screw plugs, loosen the cap or screw plugs slowly to reduce the internal pressure.



## Fire protection and explosion proof

### Prevent fire caused by the fuel oil or engine oil

The fuel oil, engine oil, antifreeze and window washing are very flammable dangerous goods. To prevent the fire, the follow regulations must be followed:

- Do not smoke or use any open fire near the fuel oil or engine oil.
- Before oil filling, shut down the engine.
- When filling the fuel oil and the engine oil, do not leave the machine.
- Tighten the caps of the fuel oil tank and the engine oil tank.
- Prevent the fuel oil overflow to the overheat surface or the parts of the electrical system.
- Ensure good ventilation in the oil filling or storage places.
- The fuel oil or engine oil shall be kept in the designated places, and no entrance without permission.
- After filling the fuel oil or engine oil, wipe off the fuel oil or engine oil overflowed.
- When grinding or welding on the lower part of the machine, transfer all the flammable materials to the safe places.
- When flushing the parts with the engine oil, use the inflammable engine oil. It is banned to use the diesel and gasoline to flush the parts to avoid fire.
- Put the towel sticking with oil or other flammable materials into the safe vessel.
- Do not weld or use the cutting torch to cut the pipe with flammable liquid.



### Prevent the fire caused by the piling of the flammable materials

- Remove the leaves, weeds, dry wood chips, paper scraps, dust or other flammable materials piled or stuck in the engine, exhaust pipe, silencer, accumulator cell and the engine cover.

### Prevent the fire caused by the electrical wires

- Prevent the fire caused by the short circuit of the electrical system.
- Keep the connections for the electrical wires clean and fixed firmly every day.
- Check the electrical wires for looseness or damage, timely tighten the loose connections or wire clamps, repair or replace the damaged electrical wires immediately.

### Prevent the fire caused by the hydraulic pipelines

- Check all of the clamps, shields and the buffer pads of the hoses and pipes for fixedness, during operating, if the parts of the hydraulic pipelines are loose, they will rub with other parts to cause damage for the hoses, result in the high pressure oil spraying and cause fire.

### Prevent explosion caused by the lighting equipment

- When checking the fuel oil, engine oil, battery electrolyte, window cleaning solution and the cooling liquid, use the lighting equipment with explosion proof performances, if not to use such equipment, it is dangerous to cause serious injury by the explosion.
- When using the power supply of the machine for lighting, the related regulations in this manual shall be followed.

### Activities when there is a fire

If there is a fire, leave the machine soon according to the following requirements::

- Turn the starting switch to OFF and shut down the engine.
- Leave the machine with the handrails and the steps.

### Cleaning solution for the windscreen

Use the Ethanol based cleaning solution. (Suggest not to use the harmful methanol based cleaning solution)

## Prevent the falling objects, flying objects and intrusive objects

In the work place where the falling objects, flying objects and intrusive objects hit or enter the driver' cab, install the necessary shields to protect the operators according to the operations.

- When working in the mine or quarry with the risk of falling stones, install the falling object protection device and the front protection device, and stick the transparent glass paper on the front glass.
- Close the front window during the above operations. Additionally, ensure other personnel are not within the falling object area and keep a certain distance from the dangerous area.
- The above contents are for the critical working conditions, it is possible to install other additional shields according to different conditions in the work place.



## Installation for the accessories

- When installing the optional parts or accessories, please contact the Xugong excavator distributor in advance.
- Any injuries, accidents or product faults caused by using the accessories or parts without approval from Xugong Excavator Mechanical Co., Ltd. will be unrelated with this company.
- When installing and using the accessories, combine the operating accessories according to the instruction manual about the accessories and the general instruction about the accessories in this manual.

Due to the different types or combinations for the working device, there is the risk that the working device crashes with the driver' cab or other parts of the machine. Before using the unfamiliar working device, check whether there is the risk to influence each other and operate carefully.

### The window glass for the driver' cab

- If the glass close to the working device in the driver' cab crushes, the working device has the risk to contact the operator body directly, please stop operating and replace the glass immediately.

### Modification without approval

Any modification without approval from Xugong Excavator Mechanical Co., Ltd. is possible to cause danger. Therefore, before modifying, please contact the distributor of Excavator Mechanical Co., Ltd.

- For any injuries, accidents or product faults caused by modification without approval from Xugong Excavator Mechanical Co., Ltd., the company will not bear any responsibilities.

### Safety in the work place

Before operating, check the work area thoroughly for dangers.

- When operating near the flammable materials (cottage roof, dry leaves or grasses) stored, it is possible to cause a fire, so it is necessary to be careful during operating.
- Check the ground situation in the work place and finalize the safest operation method. **It is banned to operate in the place with collapses or falling stones.**
- If there are water pipes, gas pipes or high voltage electrical wires buried under the work place, please contact the related companies and mark their positions, note: do not break or damage any pipes and wires.
- It is banned any unauthorized person to enter the working area, some necessary warning measures to be taken.
- Before moving or operating in the shallow water or on the soft ground, check the types and situation of the sill and the depth and the flow rate of the water.

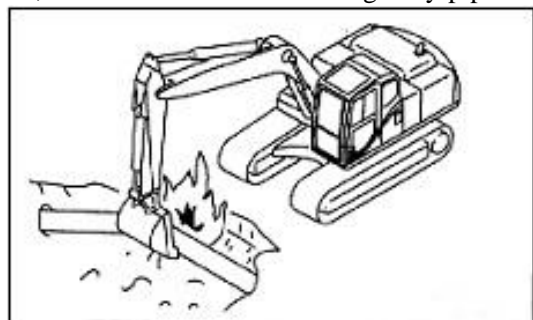

### Working on the unconsolidated ground

- Avoid walking or operating the machine near the cliff side, road side and the deep ditch. Because the ground in these areas is very soft, if the ground is collapsed under the role of the weight or vibration of the machine, it will cause the machine to collapse or roll over.
- When working on the dyke or near the groove dug, there is a risk that the earth collapses due to the weight and vibration of the machine. Before operating, necessary measures shall be taken to guarantee the safety of the ground and prevent the machine tipping over or fall off.

### Do not close to the high voltage cables

Do not walk near the cables or operate the machine, because there is a risk to suffer from electric shock and cause serious injuries or accidents. In the work place close to the cables, operate according to the following steps:

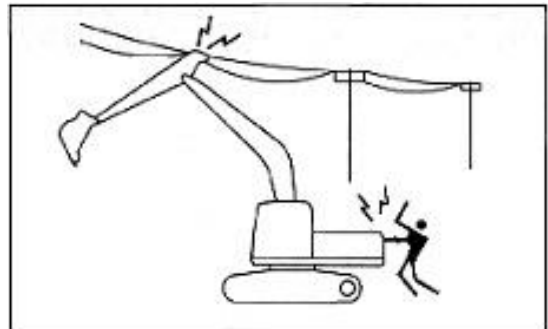

- Before starting to work near the cables, inform the local electric power company to invite them to take necessary measures.
- It is possible to suffer from electric shock in the area close to the high voltage cables, which may cause serious burning even death. So a safe distance must be kept between the machine and the cables (shown as the table below). Before starting to operate, please formulate the related safety operating measures together with the local electric power company.

- In order to prepare for the possible accidents, wear the rubber shoes and rubber gloves, lay a layer of rubber mat on the chair and note that the exposed part of the body not to contact other parts.
- If the machine is too close to the cables, a signal man is arranged to send the warning signal.
- When operating near the high voltage cables, anyone is not allowed to close to the machine.
- If the machine is too close to or touches the cables, before the power supply is cut, the operator shall not leave the driver' cab to prevent being shocked by the electricity. Additionally, anyone is not allowed to close to the machine.

	Voltage	Min. Safety Distance
Low Voltage	100V,200V	2m
High Voltage	6600V	2m
	22kV	3m
	66kV	4m
	154kV	5m
	187kV	6m
	275kV	7m
	500kV	11m

### Ensure good sight

In order to ensure safe operating or walking, please check whether there are persons or obstacles around the machine and check the situation of the work place.

- When operating in the dark area, please turn on the work light and the head light, and set the auxiliary lighting in the operating area in necessary.
- If the sight is poor, such as foggy, snowy, rainy or dusty, stop operation, please.



### Ventilation in the closed area

If it is necessary to start the engine or the treatment fuel oil, cleaning oil or paint in the closed area, open the doors and windows to ensure good ventilation to prevent gas poisoning.

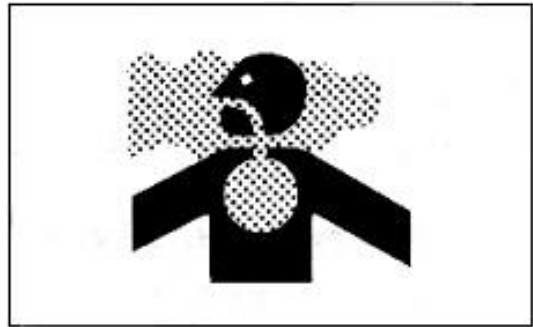

### Signals and gestures of the signal man

- When working in the road side or the unconsolidated ground, set signs, if the sight is poor, arrange one signal man. The operator shall pay attention to the signs particularly and follow the commands from the signal man.
- Only one signal man can send the signals.
- Before operating, ensure all of the workers understand all of the signals and gestures.

### Emergency exit for the driver' cab

- When emergency happened, if the door of the driver' cab cannot be opened normally due to some certain reasons, crush the rear window glass and escape from the dangerous place soon.

### Prevention for the asbestos dust danger

If too much asbestos dust in the air is breathed, it is possible to suffer the lung cancer. When dismantling or treating the industrial wastes in the work place, there is a risk to breathe the asbestos, the following rules shall be followed:

- When cleaning, spray some water to reduce the dust but not to use the compressed air.
- If there is asbestos dust in the air, operate the machine in the upwind position and all of the operators should use the dust filtering masks.
- During operation, other personnel are not allowed to close to.
- Follow the rules, regulations and the environment standard in the work place.

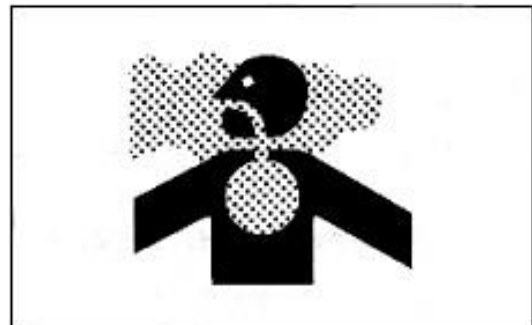

**This machine does not contain the asbestos, but the counterfeit parts contain the asbestos possibly, therefore, it is necessary to use genuine Xugong excavator parts.**

## Safe Operation of Machine

### Start the engine

If the warning label is hung on the operating lever of the operating device, do not start the engine or contact the operating lever.

### Inspection before starting

When carrying out daily work, the following inspection must be carried out before starting the engine:

- Wipe off the dirt on the surface of the window to ensure favorable sight.
- Wipe off the dirt on the surface of the lenses of the headlight and the operating light and check up if the lights work normally.
- Check up the liquid level of the cooling liquid, the fuel level of the fuel oil and the engine oil level of the engine, check up if the air filter is blocked, and check up if the circuit is damaged.
- The seat of the operator is fit to a position easy for operation, and check up if the seat belt or the attaching clamp is damaged or worn.
- Check up if the instrument works normally, check up the angle of the operating light, and check up if the whole controlling lever lies in the central position.
- Adjust the wing mirror to be convenient for seeing the rear of the machine on the driving seat.
- Check up the upper side, the lower side or the peripheral region of the machine to ensure that there is no person or barrier.



### The safety rules for starting the engine

- Honk the horn as a warning when starting the engine.
- Only allow to start or operate the machine on the seat.
- No one is allowed to sit in the machine besides the operator.
- Do not start the engine in a manner which can lead the starting motor to short circuit because it is not only dangerous, but can also damage the device.

### Starting the engine in cold days

- Sufficiently carry out preheating operation. If the machine is not thoroughly preheated before operating the operating lever and the machine may lag in response, which may cause accident.
- If the electrolyte of the battery is frozen, do not charge the battery or start the engine by other power to avoid fire on the battery. Ensure that the electrolyte of the battery is dissolved before charging or starting the engine by other power.

## Operation

### Inspection after starting the engine

When carrying out the inspection, move the machine to a wide area without any barrier to operate slowly. **No one is allowed to approach the machine.**

- Check up if the action of the machine is the same as the display on the controlling mode instrument. If not, change it into the right mode at once.
- Check up the operation of the instrument and the device, and check up the operation of the bucket, the bucket rod, the swing arm, the moving system and the steering system.
- Check up if the voice, the vibration, the heating, the smell and the instrument of the machine works normally, and check up if the engine oil or fuel oil is in leakage.
- Repair the machine at once if there is any unusual thing.

### Safety rules for changing the direction of the machine

- Before moving, the upper structure should be located at the proper position to make the chain wheel located to the rear of the cab. If the chain wheel is in front of the cab, the operating direction is reversed (for example: going forward is changed into going backward and the left into right). Before moving, make sure again that there is no person or barrier in the peripheral region.
- Before moving, honk the horn to warn the person in the area.
- Only sit on the seat to operate the machine.
- No one is allowed to sit on the machine besides the operator.
- Check up if the moving warner (if there is a warner) works normally.
- Ensure that the door or the window of the cab is locked.
- There is a blind area at the rear of the machine. When the machine is turning a corner or turning around, a signalman is needed. Especially pay attention not to touch other machine or person. Abide by the matters of attention above even if the wing mirror is arranged on the machine.

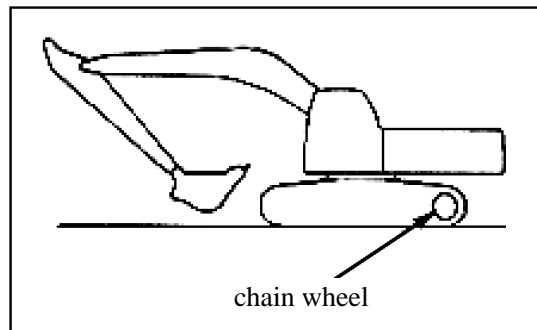

### Safety rules for moving

- Do not exceed the maximum permissible load when using the machine in order to prevent that the machine is unstable because of overload and avoid the damage of the working device.
- When moving on the flat ground, taking back the working device and the bottom of the bucket must be kept 40 to 50cm above the ground.
- When moving on the rough ground, move slowly and do not swerve to avoid roll-over. If the working device touches the ground, the machine may lose balance and be damaged.
- When moving on the rough ground or the abrupt slope, turn off (cancel) the automatic speed reducing switch, if the machine is equipped with the automatic speed reducing device. If the automatic is turned on, the rotate speed of the engine is increased, and the moving will be suddenly accelerated.
- Avoid moving on the barrier as far as possible. If the machine has to move on the barrier, make the working device close to the ground and move slowly.
- When moving or carrying out operation, keep a certain safety distance from person or building to avoid collision.
- When passing the bridge or building, firstly check up if the structure is strong enough to support the weight of the machine. When moving on the road, consult relevant department to inspect and then comply with their guidance.
- When operating in a tunnel, under a bridge, a wire, or in other place with limited height, operate slowly, and especially avoid the working device from touching anything.

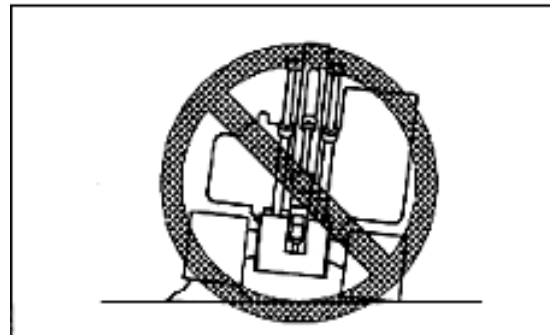
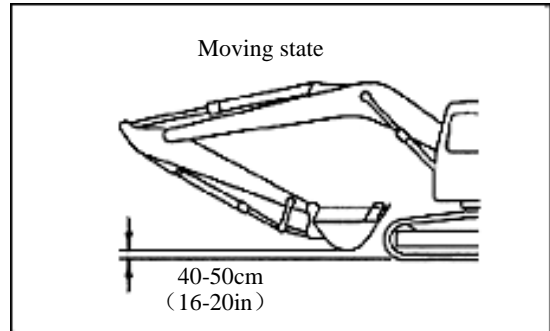

### Equipment Protection Top. ROPS or FOPS

If the machine is operated at the region with falling stores and aggregates, the machine should be provided with devices of the equipment protection top, ROPS or FOPS according to the potential dangerous situation.

(The standard driving cab of the machine is equipped with devices of ROPS and FOPS)

ROPS: Roll Over Protection Structure

FOPS: Falling Object Protection Structure

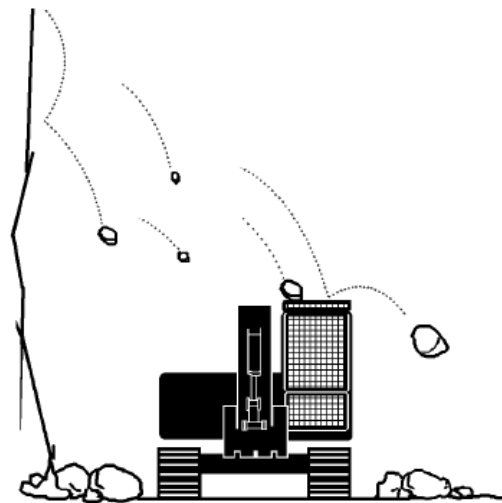

### Moving on the Slope

In order to prevent the roll-over or the sideslip of the machine, the following requirements must be achieved:

- When the machine moves on the slope, the bottom of the bucket is 20 to 30 cm (8 to 12 in) from the ground. In an emergency, the working device can rapidly drop down to stop the machine.
- When the machine moves upslope, the driving cab is adjusted to the direction of the upslope. When the machine moves on the slop downwards, the hardness of the ground surface in front of the machine must be examined.

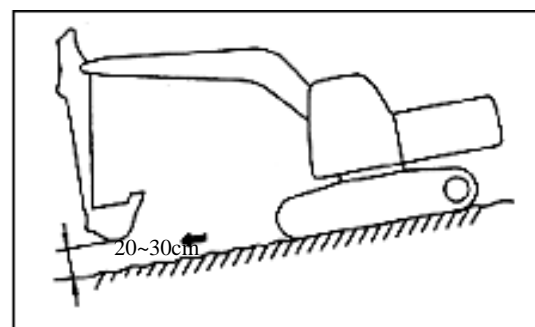
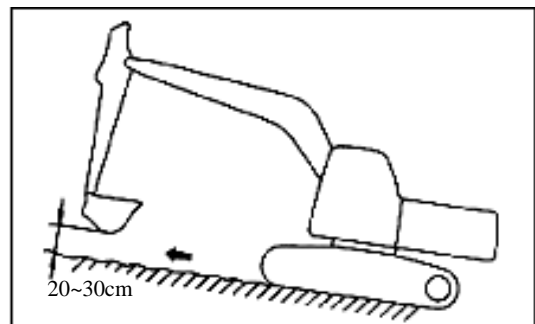

- When the machine moves on the abrupt slope, the working device extends towards the front direction to maintain the balance, and the operating equipments keep the distance of 20 to 30 cm from the ground, and keep at a low speed.
- When the machine moves on the slop downwards, the moving operating lever is maintained at the middle position, and the machine moves at low speed.

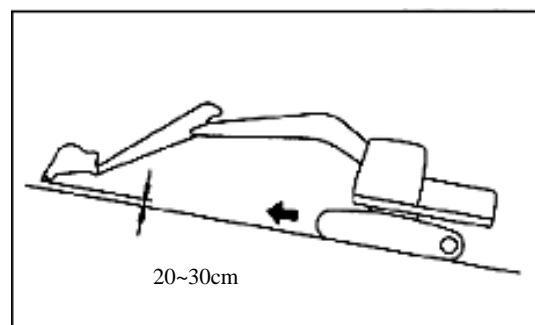

- The machine directly moves on the slope upward and downwards, because it is very dangerous to make a turn or traverse on the slope.
- Do not make a turn and transverse on the slope. The machine should change the position of the machine at the flat area, and then, go up to the slope.
- Because the slipping of the machine on the slope of a small degree is dangerous, the machine should walk on the slope at low speed.
- In the engine misses when the machine is moving on the slope, the operating lever must be shifted to the middle position to start the engine.

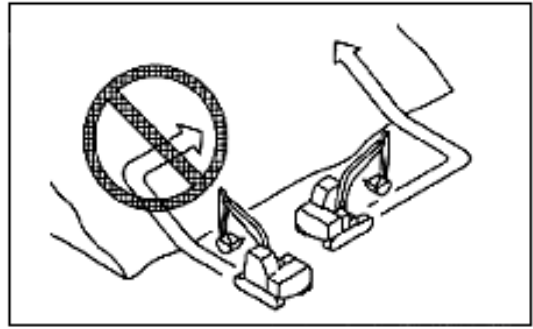

### Operation on the Slope

- When the machine operates on the slope, and the revolution or working device is operated, the machine will lost balance and incline so as to cause the serious damage or equipment breakdown. Therefore, When these erations are carried out, a small flat area needs to be provided, and the operation needs to be carried out carefully.
- Do not make the working device turn from the side of the upslope to the side of the down slope when the bucket is fully filled. The operation of making the working device turn will make the machine roll-over.
- If the machine must be used on the slope, a platform must be piled up to maintain the balance of the machine.

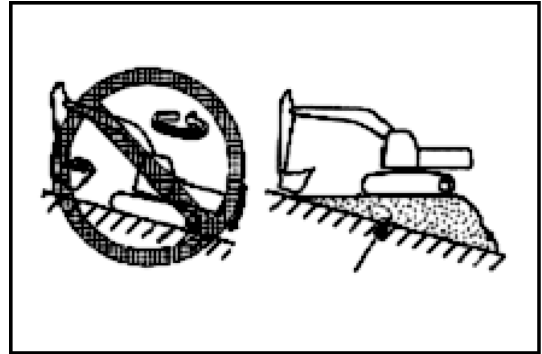

### Forbidden Operation

- Do not dig the working surface under the suspended part. The operation will cause the danger of store falling or collapse of the suspended part, and the danger of store falling on the machine.

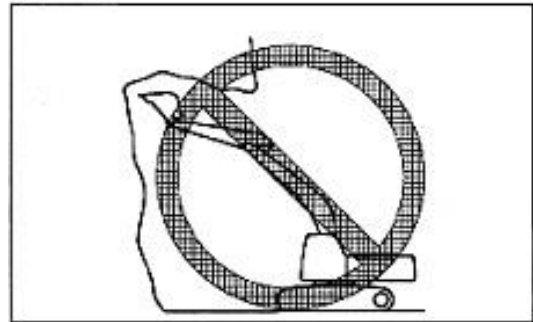

- Do not deeply dig the ground in front of the machine. Otherwise, the ground under the machine will collapse to make the machine fall.

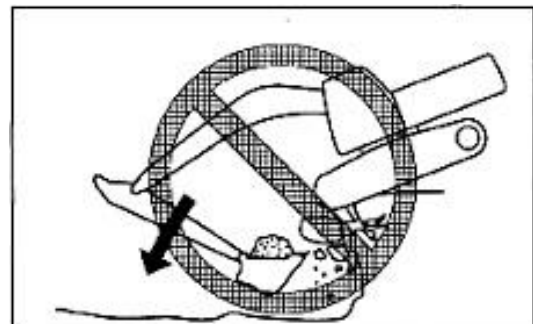

- When the digging operation is carried out, the caterpillar band is adjusted to form a right angle with waysides or cliffs at the base of chain wheels in order to easily make the machine leave at any situation.

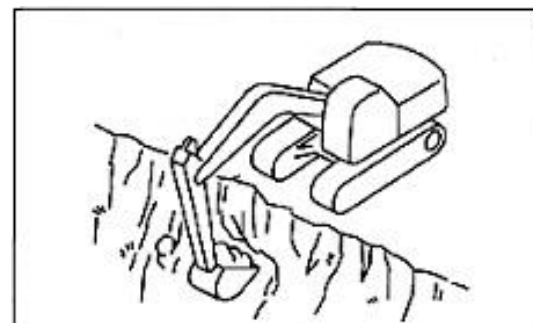

- The dismantling operation is forbidden to carry out under the machine, and the dismantling operation will cause the unsteadiness of the machine and has the risk of roll-over.
- When the machine operates on the buildings and the upper part of other structures, the buildings will be seriously ruined or damaged.

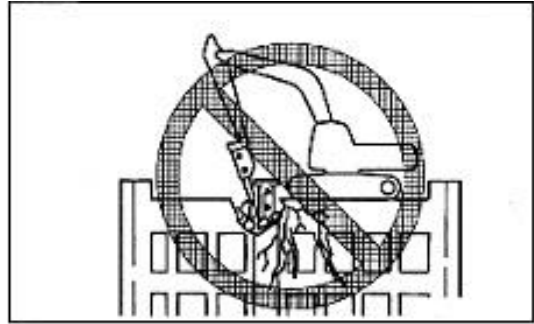

- Removing the part above the machine is forbidden when the dismantling operation is carried out. The ruin or the damage caused by the broken part falling or the building collapse is prevented.
- The breaking operation carried out by the impact of the working device is forbidden to avoid the injure or damage caused by flying objects.

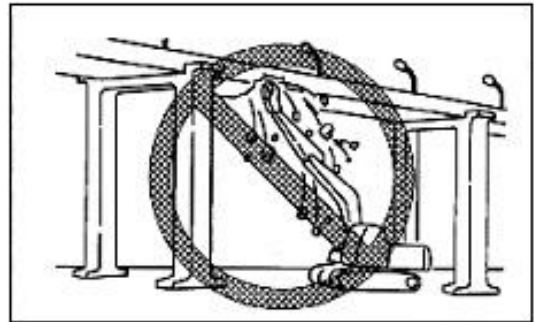

- Generally, the working device on the side is easy to incline than the working device in the front or at the back.
- When crushers or other heavy working device is used, the machine has the danger of losing balance and tipping over. When the machine operates on the flat area and slopes:
- Do not suddenly drop, rotate or stop the working device.
- Do not make the swing arm hydro-cylinder suddenly stretch out or shrink. In this way, the impact will cause the danger of the tipping of the machine.
- Do not put the bucket above the heads of other workers or seats of operators of other transporting equipment. Because the loaded stuffs maybe drop, the bucket can contact the dump trucks so as to cause serious ruin or damage.

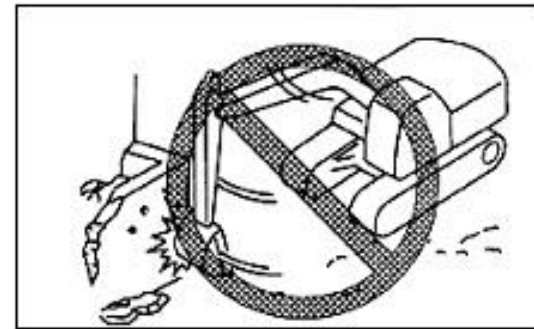



### Operation in Snowy weather

- Do not put the bucket above the heads of other workers or seats of operators of other transporting equipment. Because the loaded stuffs maybe drop, the bucket can contact the dump trucks so as to cause serious ruin or damage.
- The iced ground surface becomes soft when the temperature rises up, and the machine will roll over.
- If the machine enters into the snow, the machine will incline or be buried in the snow.

### Machine Parking

- The machine parks on the firm and flat ground.
- The machine should park on the place free of falling rock or collapse.
- Descend completely the working device to the ground

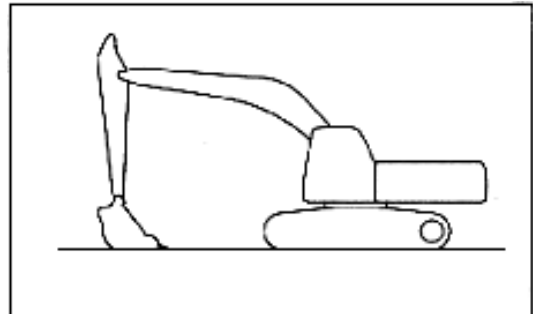

- When leaving the machine, the safty locking lever ① is adjusted to the locking positions, and then, the engine is shut down.
- In order to prevent people without permission from moving the machine, the door of the driving cab needs to be locked, and the key needs to be taken off to carry or put to the specified place.

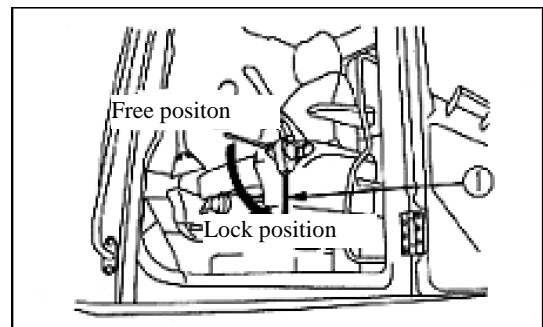

- If the machine must be parked on the slop, the following rules must be obeyed
- The bucket is adjusted to one side of the down slope, and the bucket is inserted to the ground.
- Pads are put under the caterpillar band in order to prevent the move of the machine.

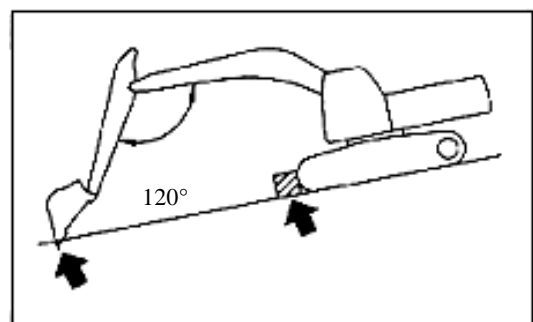

## Transportation

In order to conveniently transport the machine, the machine is divided to several parts. Therefore, please contact with the dealers of Xugong excavator to carry out the transportation work.

### Machine Transportation

When the machine is transported by trailers, the following rules need to be obeyed:

- According to the weight, the width and the length of the machine, the trailers are selected, and the transportation route is determined. On such an occasion, user can contact with Xugong excavator dealer to carry out the equipment disassembling work.
- When the machine passes through bridges or buildings, the structural strength must be examined to judge that the structural strength can bear the weight of the machine or not. When the trailers drive on the road, the trailer must be examined by relative departments and obey the guidance of relative departments.

## Battery

### Prevention of the Danger caused by Battery

The electrolyte of the battery includes sulfuric acid, so the inflammable and explosive hydrogen is generated by the battery. The operation error can cause serious damage or fire hazards, so the following items must be obeyed:

- If the display of the densimeter is black, the electricity must be charged. If the display of the densimeter is bright, the battery must be changed.
- When operating the battery, goggles and rubber sleeves should be worn.
- It is prohibited to smoke or use open fire near the battery.



- If the sulfuric acid splashes the clothes or the skin, the clothes or the skin must be washed by a large amount of water.
- If the sulfuric acid enters into the eyes, the eyes must be washed by a large amount of water, and the injured must go to hospital.

During the battery operation, the battery maybe generates sparks, and the key switch must be turned to the 'close' position. The operations must be carried out according to the following steps:

- Do not make tools or other metal objects contact between the battery terminals. Do not let tools or other metal objects drop around the battery.
- When the battery is disassembled, the negative terminals (grounding side) must be disconnected at first. When the battery is installed, the positive terminals must be connected at first, and then, the positive terminals are connected to the ground.
- At the time of charging the battery, the inflammable and explosive hydrogen is generated. Before charging, the battery must be disassembled from the machine and put to a drafty place.
- The battery should be firmly installed to the original position.

## Starting engine with auxiliary cable

If the auxiliary cable is connected in the error way, the battery may explode, and therefore, the following rules should be followed:

- When the engine is started with the auxiliary cable, two persons are necessary to carry out operation (one person sits in the operation seat and the other operates the battery).
- When using another machine to start, the two machines should not contact.
- Before the auxiliary cable is connected, the start switches of normal machine and fault machine should be turned to 'off'. Otherwise, when the power is supplied, the machine may move.

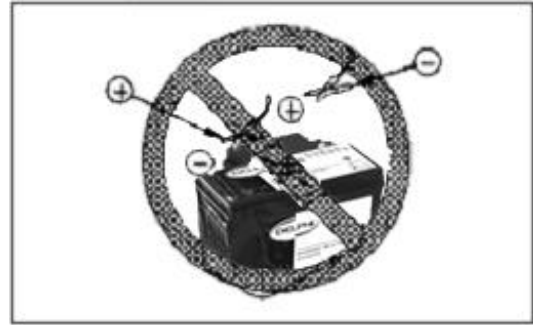

- When the auxiliary cable is installed, positive (+) must be firstly connected. When the auxiliary cable is removed, ground or negative (-) cable (grounding side) must be firstly disconnected.
- When the auxiliary cable is removed, auxiliary cable clamps should not touch each other, and cable clamps and machine also should not touch together.

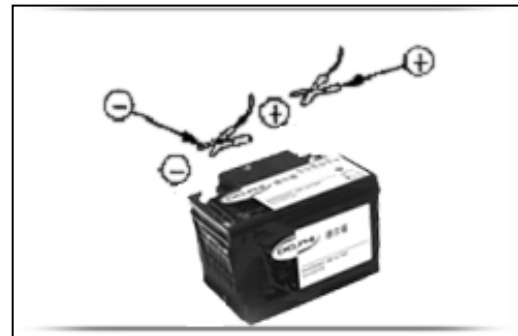

- When the engine is started with the auxiliary cable, goggles and rubber gloves must be worn.
- When the normal machine and the fault machine are connected by the auxiliary cable, the normal machine which has the same battery voltage with the fault machine should be used.

## Traction

### Safety rules of traction

If the fault machine is not correctly pulled, or the selection and check of wire ropes are wrong, serious injury or death will be resulted.

- When the wire ropes are used, leather gloves will be worn.
- The wire ropes are fixed on a machine frame.
- In the traction process, persons should not stand between traction machine and machines which are pulled
- The machines should not be pulled on slopes.

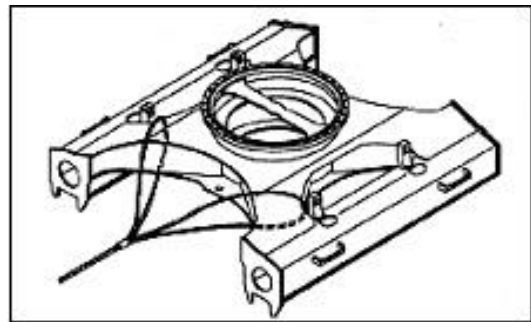
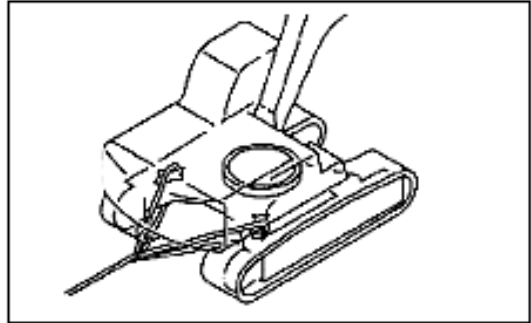

- The wire ropes with broken wires (A), diameter reduction (B) or bending (C) should not be used. In the traction process, the wire ropes may be broken easily, and then, dangerous accident will be caused.

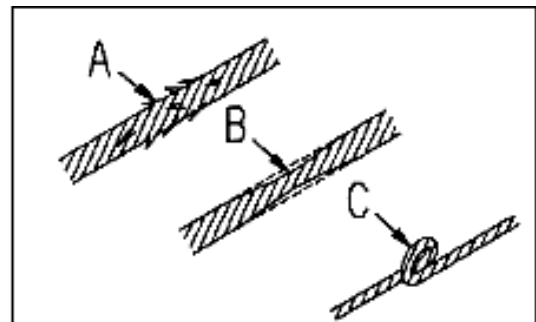

## Lifting objects by the bucket

### The safety rules for lifting objects

- The lifting operation should not be carried out on slopes, soft ground or other places where machines put unstably.
- The wire ropes must meet the required standard.
- Observe at any moment, and notice whether machines roll over.
- Before the machines rotate or turn, persons must inspect carefully whether other persons or buildings are around the peripheral region, and the collision should be avoided.
- Do not start, turn, or stop the movement of the machine to avoid object oscillation.
- Do not lift objects at the side or towards the machine.
- When the objects are lifted, the operators should not leave seats.
- **Using the machine to lift the objects is dangerous, which is prohibited in principle.**

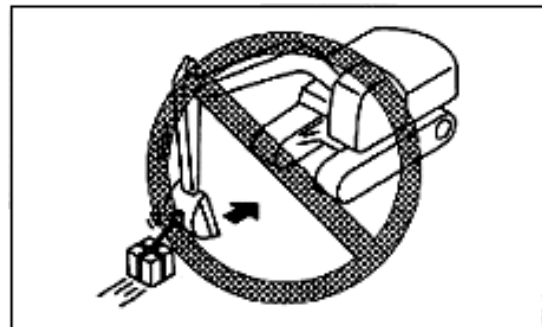
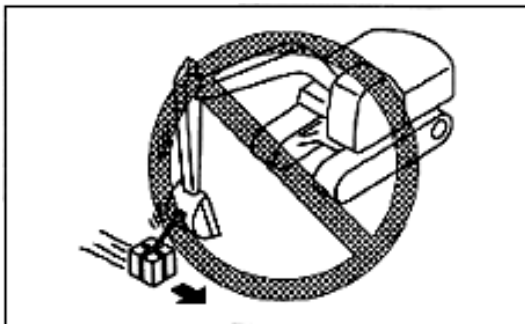

### Warning !

- The appropriate accessory devices are selected according to the machines which are installed with the accessory devices. The installed machine types will be different according to the accessory device types.
- Please contact with the authorized special service center of XUGONG excavators.

## Optional component-Hydraulic hammer

Main functions:

- Crushing rocks
- Demolishing
- Road repair

Hydraulic hammer is widely applied in demolishing buildings, crushing road surfaces, excavating tunnels, crushing cinders, and crushing or cutting rocks.

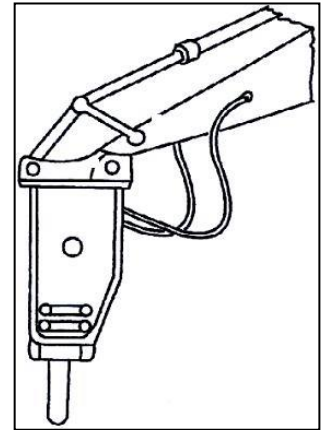

Press tightly the drill rods onto the surface at a right angle, as shown in figure.

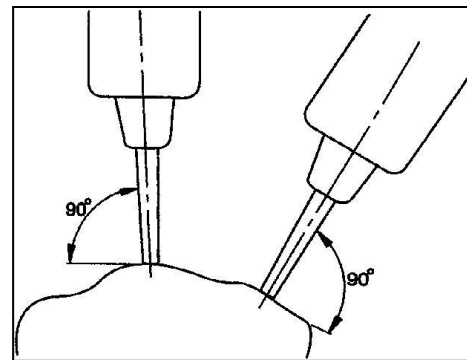

When striking, the drill rods will be pressed tightly on the surface, and the machine frame is lifted above about 5 cm. Never carry vehicle too high.

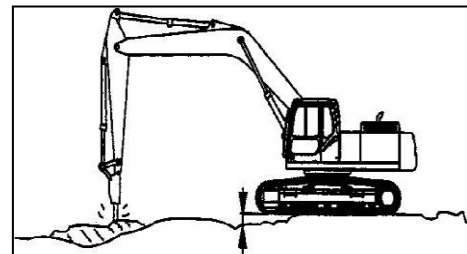

If the surface is repeatedly struck, but not broken in 1 minute, the hammer should be moved and break the surface from the edge.

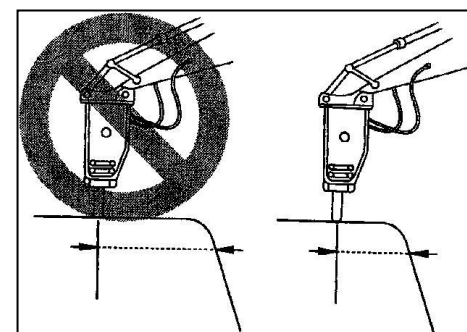

The striking direction of the drill rod is slight deviated from the direction of the hammer. Therefore, the direction of oil cylinder of the bucket must be rectified to ensure the direction alignment.

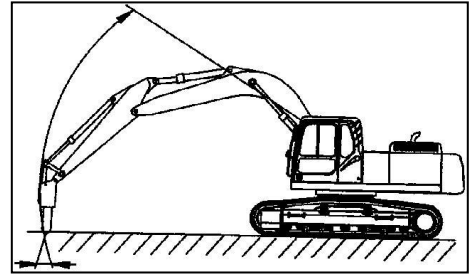

**Matters needing attention of the hydraulic hammer**

In order to avoid void striking, the drill rod should be pressed when needed.

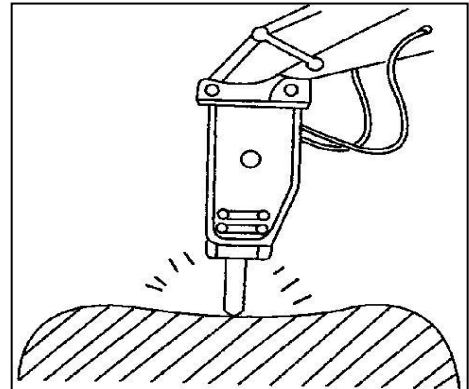

When the oil cylinder is operated, the rip end should not be reached, and the distance is kept about 5 cm.

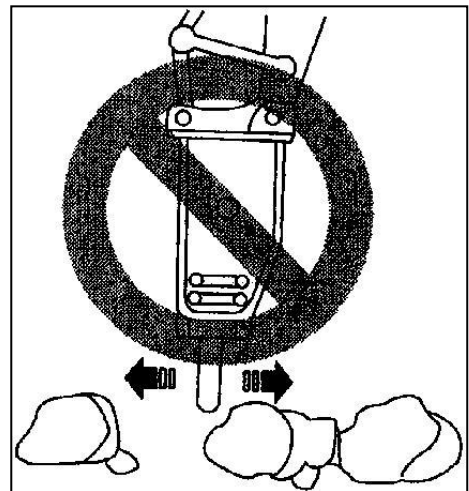

Do not swivel the hydraulic hammer when working on rocks, concrete and so on.

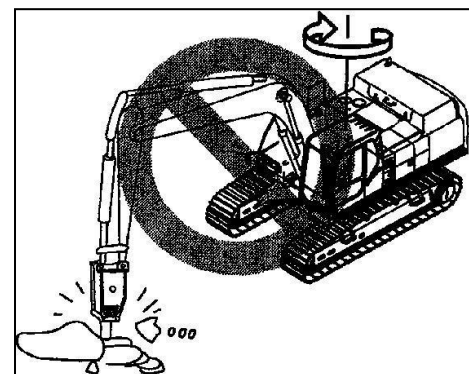



When striking, do not move the drill rod.

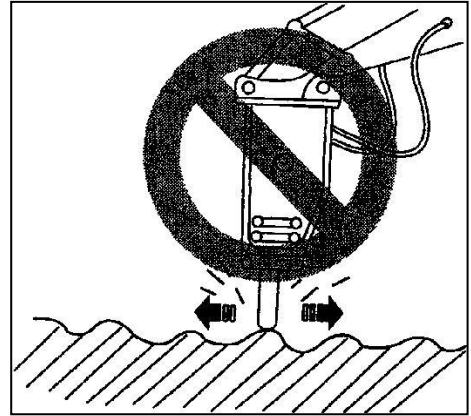

Do not strike horizontally or upward.

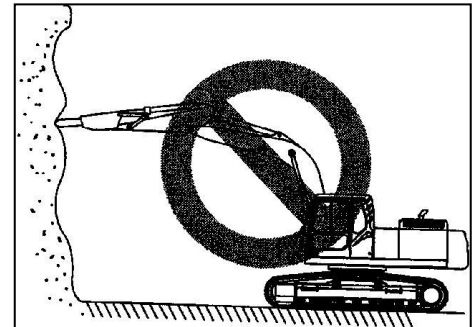

When punching on the ground, do not twist the drill rod.

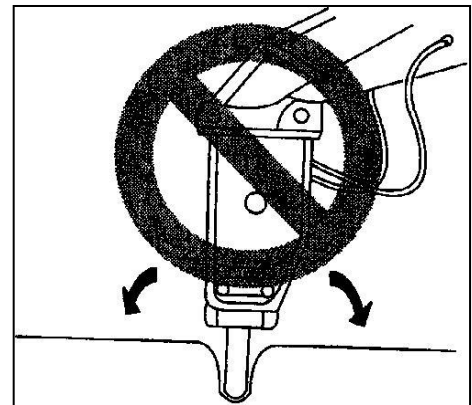

When lifting the machines, do not make the bucket oil cylinder to elongate to the maximum position.

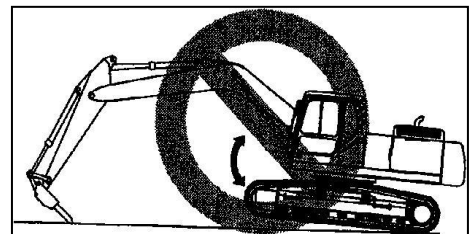

## Safety maintenance instructions

### Warning labels

- 'No operation' warning label must be hung on work device operating lever in the cab to warn that someone is maintaining the machine. If necessary, the warnings should also be published around the machine.
- Put the warning away in the tool box.

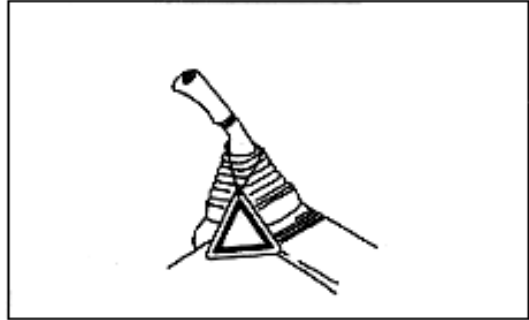

- When maintaining, if someone starts the engine, contacts or operates the working device operating lever, serious injury or machine damage will be caused.

### Keeping the work area clean and tidy

- Do not scatter the hammer or other tools in the work area. Wipe off all slippery grease, oil or other substances. Keep the work area clean and tidy, so as to secure the working process.

If the work area is not kept clean and tidy, persons may stumble, slip or drop, and cause injury.

- Top window which is made by organic glass (polycarbonate) should be cleaned with water, and not with any alkaline solvent. If benzene, toluene, methanol or other basic solvent are used, chemical reaction will be caused, like that glass is dissolved or decomposed, and polycarbonate will age.

### When persons work with others, one header should be commanded.

- When the machines are fixed, or when the work device is removed, one header should be commanded, and then, other persons obey his command in the operating process. When working together, persons that do not mutually know can lead to serious accidents.

### Shut off the engine before maintenance

- The machine should be stopped on solid and flat ground surface.
- The place with not fallen stones, collapses or is of no danger of being submerged should be chosen.
- Completely descend the working device onto the ground, and shut off the engine.
- Put stopper blocks under the crawler belt in order to prevent the machine moving.

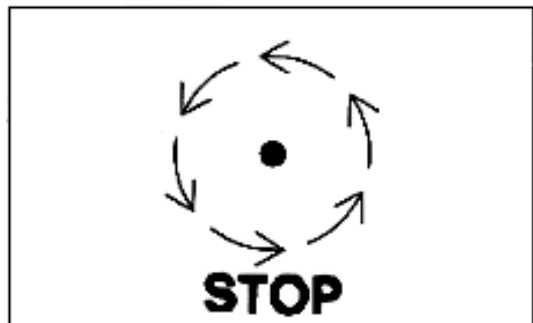

## When the engine is running, two persons carry out the maintenance.

To prevent damage, when the engine is running, the maintenance should not be carried out. If the maintenance must be carried out when the engine is running, two persons operate at least, and do following rules::

- One person must sit in the operation seat and be ready to shut off the engine. All persons must keep in communication with each other.

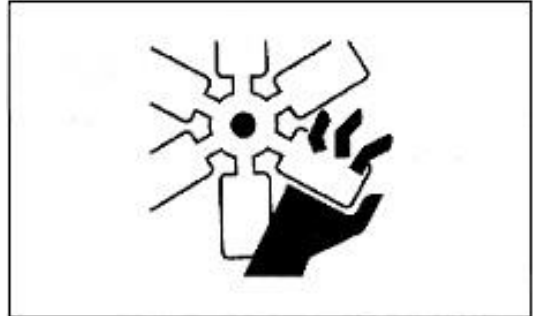

- Pull the safety lock control rod to the locked position.
- When operate near fan, fan belt or other rotating parts, the operator must pay special attention to prevent being coiled.
- Prohibit touching any operating lever. If necessary, the operator needs to send signals to other persons to warn them moving to a safe place.
- Never insert tools or other objects into the fan or the fan belt, otherwise the parts will break or fly out.

## Suitable tools

The suitable tools should be correctly used, and damage, inferior, flawed and temporary tools or inappropriate tools may cause serious injury.

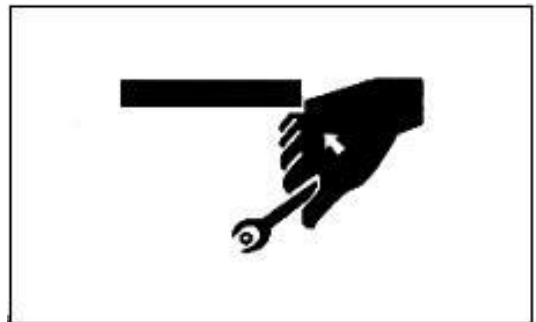

### Energy container

The energy container is filled with high pressure nitrogen.

When operating on the energy container, the careless operation will cause explosion, and cause serious injury or damage. Therefore, the following matters need to be paid attention:

- Do not decompose the energy container.
- Do not approach the energy container to the fire.
- Do not punch and weld on the energy container, or use the welding torch on the energy container.
- Do not collide or roll the energy container, and do not make the energy container suffer any impact.
- When disposing the battery, gas must be discharged.

Please contact with XUGONG excavator dealer to deal with this task.



### Personnel

Only trained personnel is allowed to maintain or to repair the machine, no one without training is allowed to enter the area.

### Accessories

- Before removing or installing the accessories, a header will be commanded.
- The accessories which are removed from the machines should be put in a stable place where the accessories do not fall. Measures should be taken to prevent unauthorized persons from entering storage area.



### Working under the machines

- If the low surfaces of the machines or the working device need to be maintained, pads and frames which are strongly enough to support the weight of the working device and the machine should be used to support the working device and the machine.
- If the crawler belt leaves the ground, the machine is only supported by the working device; if the operating lever or hydraulic pipes are accidentally touched, the working device or the machine may suddenly fall. If the pads or the frames are not used to support the machines, working under the machine is prohibited.



## Noise

- If the noise of the machine is too loud, temporary or permanent hearing problems can be caused.
- When persons maintain the engine and suffer the noise for a long time, ear covers or earplugs should be worn.

## Using the hammer

When using the hammer, pins may fly out, metal particles may scatter, the serious damage can be caused, and then, the following steps need to be followed:

- If the hammer is used to strike hard metal parts, such as pins, bucket teeth, blade or bearings, fragments may scatter and cause harm, and therefore, goggles and gloves should be worn during operating.
- When striking the pins or the bucket teeth, the fragments may fly out, the surrounding area must not have persons, and then, the injury is avoided.
- If struck strongly, the pins may fly out and cause damage to the surrounding persons.

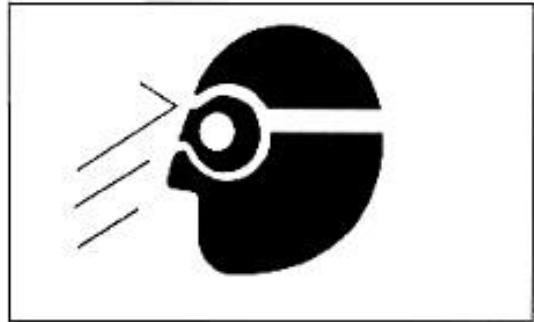

## Welding operation

Only the proper device can be used, and the operation shall be performed by qualified welders.

## Removing the battery terminals

When repairing electrical systems or welding, the terminals of the battery anode (-) will be dismantled, which prevent the current from flowing.

### When the crawler belt tension is adjusted with high-pressure grease, the safety need be paid attention to.

- The grease is pressed into the crawler belt tension adjustment system under the condition of high pressure. When adjusting, if the maintenance procedure is not observed, the grease emission plug ① will fly out, which will cause serious injury or damage.

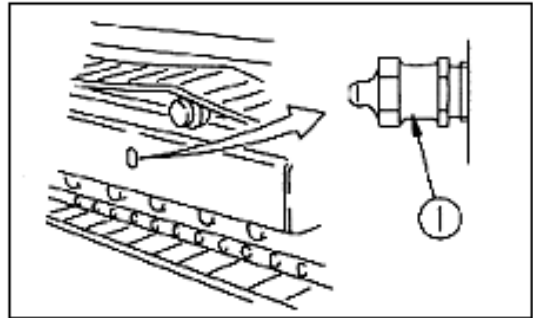

- In order to relax the crawler belt tension, the grease emission plug ① is loosened, the emission plug which is loosened is not turned over one lap, and simultaneously, the grease emission plug must be loosened slowly.

- Do not approach face, hands, feet or other body parts to the grease emission plug ①



### Do not remove the buffer spring

The buffer spring assembly is used to alleviate the impact force of tension pulley, the buffer spring includes a high-tension spring, if the high-tension spring is removed in a wrong way, the spring will fly out, which causes serious injury or death.

### Relevant safety rules of high pressure oil

The internal part of the hydraulic system always has pressure; when checking or replacing pipes or hoses, the pressure in the hydraulic oil pipe must be checked whether has been released or not. If oil pipe still has the pressure, serious injury or damage can be caused, so the following rules need to be done:

- When the hydraulic system has the pressure, before releasing the pressure, do not carry out check or replace.
- If the surrounding area of the pipes or the hoses is wet, the pipes or the hoses should be checked whether break or not, and whether the hoses inflate. When checking, goggles and leather gloves should be worn.
- The high pressure oil which leaks from small orifices can penetrate into skin, and may cause blindness if contact directly. If skin or eyes which are contacted with the high pressure oil were injured, skin or eyes should be flushed by clean water and go to hospital for treatment.



## Safe Operation of High Pressure Hose

- If the hose leaks, it may cause fire or faulty operation, resulting in serious injury or damage. If the bolt loose is found, stop operations and screw up/down the bolts to the specified tightening torque. If there is any damage to the hose, stop the operation immediately, and contact with the excavator dealer of XUGONG.
- If there are any of the following problems, replace the hose:
  - Damage or leakage of hydraulic pipe connection.
  - Cladding frayed or disconnected, or strengthening layer wire exposed.
  - Cladding expands in some places.
  - Movable parts distorted or crushed.
  - Impurities inside cladding.

## Waste

To prevent pollution, particular attention should be paid to the treatment of waste:

- Discharge the oil from the machine into the container; do not discharge it directly to the ground, or into the sewers, rivers, oceans or lakes.
- When dealing with hazardous materials, such as engine oil, fuel oil, cooling fluid, solvents, filter and batteries, it is necessary to comply with the laws and regulations.

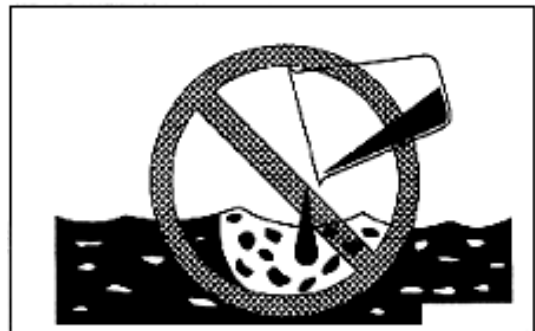

## Air Conditioner Maintenance

If the air conditioner refrigerant gets into the eyes, it may cause blindness; if the refrigerant comes into contact with skin, it can cause frostbite.

## Compressed Air

- When cleaning with compressed air, the particles flying out may cause injury on person or damage on machines.
- When cleaning filter or radiator with compressed air, make sure to wear goggles, dust masks, gloves and other protective equipment.

## Periodic Replacement of Safety-critical Parts

- For long-term safety of in operation of the machine, there is need for regular lubrication and maintenance. To further enhance security, the safety-related parts such as hoses, seat belts should be periodically replaced.
- When exceeds the allotted time, the material of parts will naturally change. Reuse will cause deterioration, wear and damage. Finally, these parts may break down and cause serious injury or damage. When the operating, it is difficult to judge how long these parts can keep working according to an external inspection or touch, so replace it regularly
- If there are any defects in safety-critical parts, replace or repair it even it has not reached the allotted time.

# Name of Parts

General drawing

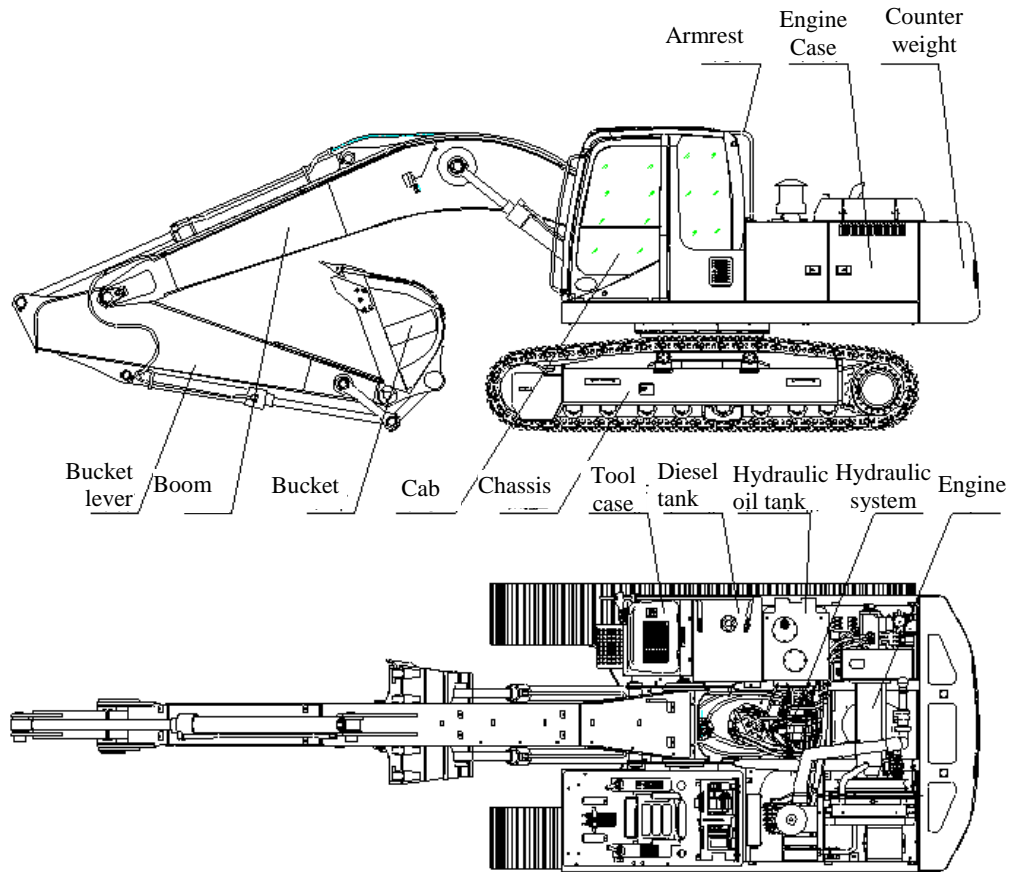



### Cab

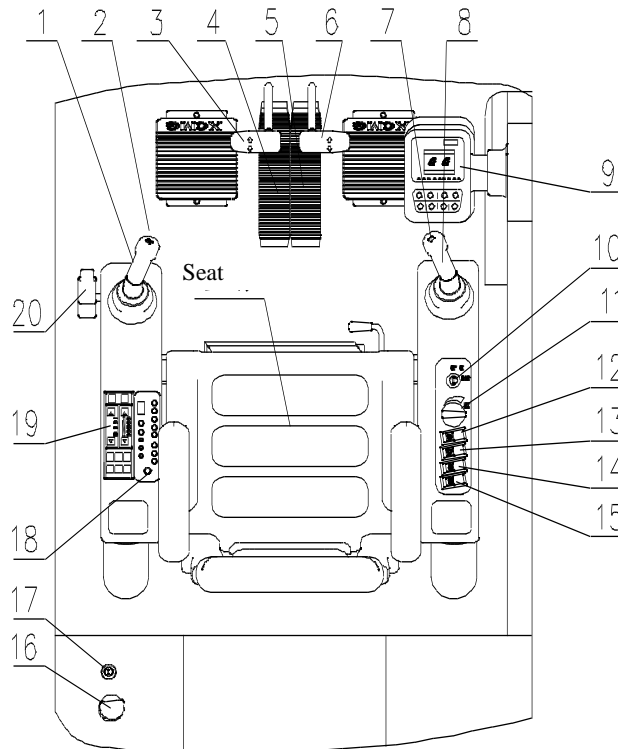
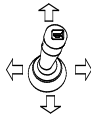





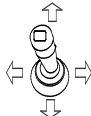

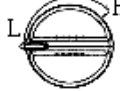





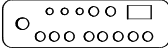

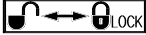

Fig.1-27 layout of operational and indicating parts in cab

- |  |   |                                |
|--|---|--------------------------------|
| 1 left operational lever                             | 2 horn switch(above left operational lever) | 3 left treading control lever  |
| 4 left treading pedal                                | 5 right treading pedal                      | 6 right treading control lever |
| 7 boosting switch (above right operational lever)    | 8 right control lever                       | 9 monitor                      |
| 10 key switch of engine                              | 11 engine speed knob                        | 12 switch for arm lamp         |
| 13 switch for working lamp                           | 14 switch for wiper                         | 15 switch for washer           |
| 16 button for emergency cutoff (optional attachment) | 17 cigarette lighter                        | 18 switch for radio            |
| 19 control button for air conditioner                | 20 safe locking lever                       |                                |

List 1-4 Illustrated signal

Serial No.	Name	Signal	Function
1	Left operational lever		Control the arm stretching and retracting and the rotation of the up carriage
2	Horn switch (on top of left operational lever)		Enable the horn to sound after being pressed
3	Left treading control lever		Control the advancement and reversing of leftside crawler
4	Left treading pedal		Control the advancement and reversing of leftside crawler
5	Right treading pedal		Control the advancement and reversing of rightside crawler
6	Right treading control lever		Control the advancement and reversing of rightside crawler
7	Boosting switch (on top of right operational lever)		After being pressed, the max.excavation force can be obtained in short time
8	Right control lever		Control the rising and descending of moving arm as well as excavation and unload of bucket
9	Monitor		Operation, indication and warning(for details, see the latter introduction)
10	Key switch of engine		Start, run and stop the engine
11	Engine speed knob		Adjust the engine speed
12	Switch for arm lamp		Control the working lamp of moving arm
13	Switch for working lamp		Control the right working lamp
14	Switch for wiper		Control the wiper of front window of cab
15	Switch for washer		Control the washer of front window of cab
16	Button for emergency cutoff		Emergency cutoff of engine
17	Cigarette lighter		Control the lighting

18	Switch for radio		Control the radio
19	Control button for air conditioner		Control the air conditioner
20	Safe locking lever		Control hydraulic guidance oil

### Monitor

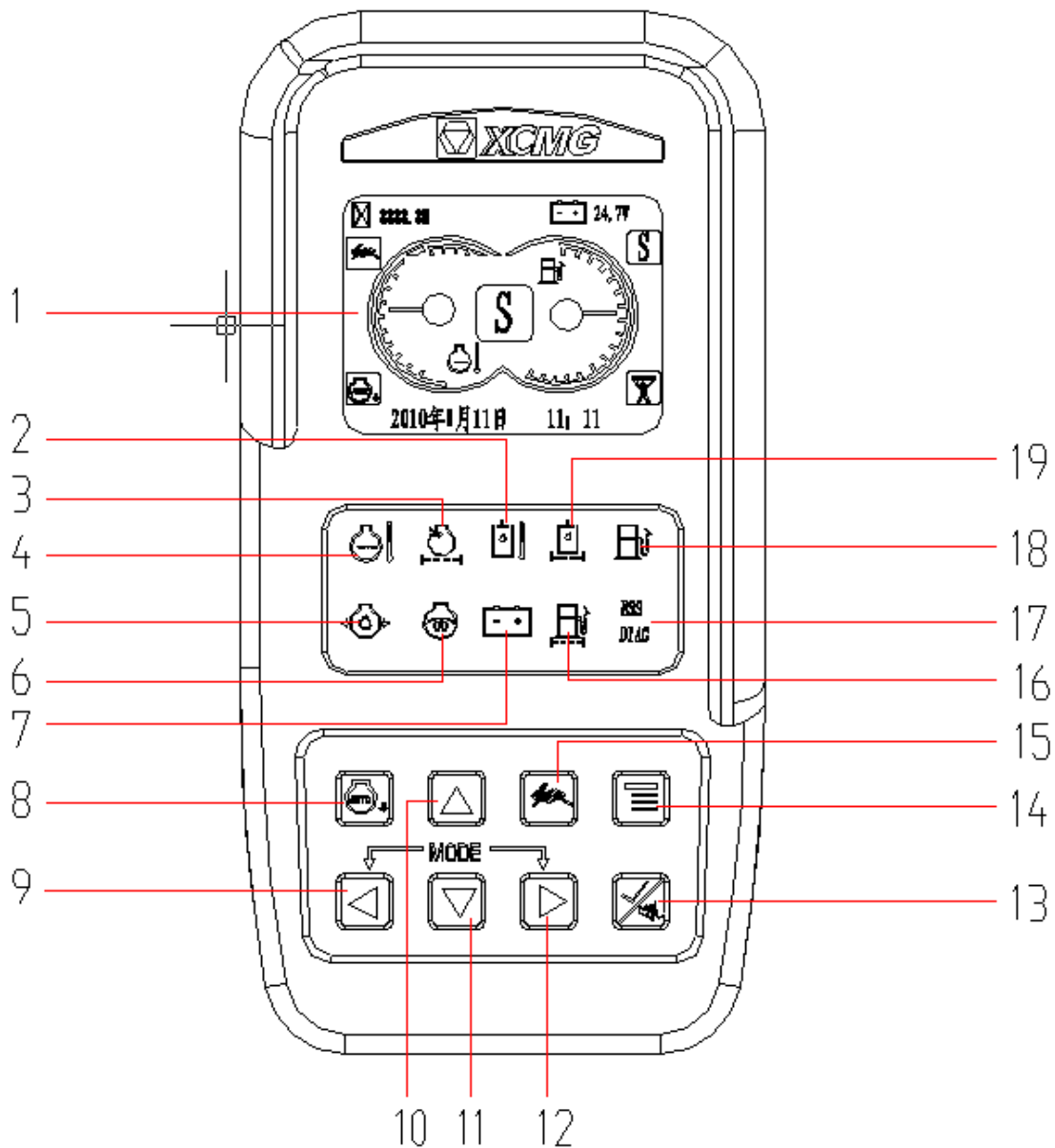

















Fig. 1-28 Picture of monitor interface

List 1-3 List of illustrated signals

Serial No.	Name	Signal	Function
1	Indication interface of screen		Screen indication or main menu catalogue(for details, see the latter introduction)
2	Alarm of hydraulic liquid temperature		On for a high temperature
3	Air filter blockage alarm		On for a blockage in the air filter

4	Engine coolant high temperature alarm		On for high temperature of engine coolant
5	Oil pressure alarm		On for low pressure of engine oil
6	Engine preheat indicator		On for the process of engine preheat
7	Charge alarm		On for abnormal engine battery charge
8	Idle button		When the machine is started, automatic idle speed is set by default. Being pressed once, the automatic idle speed is canceled. Being pressed again, the automatic idle speed is restored.
9	Button for choosing work mode		When the machine is started, mode S works. Being pressed once, circular options is made in order of S→H→B→L→S
10	Up/ button of increase		Being pressed, cursor move upward once after entering the main menu catalogue
11	Down/ button of decrease		Being pressed, cursor move downward once after entering the main menu catalogue
12	Button for choosing work mode		When the machine is started, mode S works. Being pressed once, circular options is made in order of S→L→B→H→S
13	Muffling/identificating button		Being pressed, warning sound stops; Confirm the cursor column after entering the main menu
14	Button for menu/changing screen		Being pressed once, it shows the optional indication interface in order of “main menu→chart→main menu” in cycle
15	Fast/slow treading button		Being pressed once, it shows treading mode will be chosen circularly in order of “fast→slow→fast”
16	Fuel filter blockage alarm		On for a blockage in the fuel filter
17	Malfunction indicator	ESS DIAG	ESS malfunction indicator
18	Fuel oil level alarm		
19	Leading hydraulic filter blockage alarm		On for leading hydraulic filter blockage

- Displaying interface of main screen:

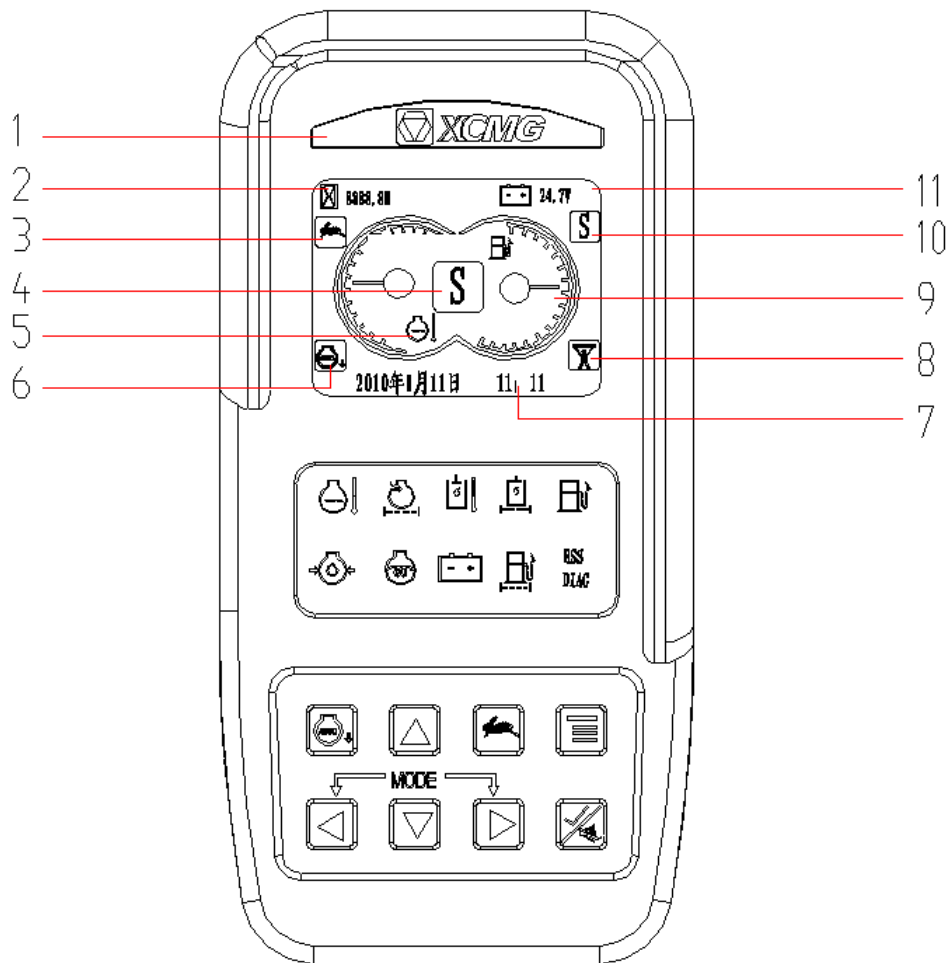

- |                               |   |                                   |
|-------------------------------|---|-----------------------------------|
| 1 Trademark                   | 2 Working hour meter                    | 3 Moving speed low/high indicator |
| 4 Alarm and switch blink      | 5 Water thermometer                     | 6 Automatic idle indicator        |
| 7 Time and information prompt | 8 Instantaneous reinforcement indicator |                                   |
| 9 Oil level display           | 10 Working mode indicator               | 11 System voltage indicator       |

- Instructions for instrument displaying interface:

a) When the key switch is turned to ON, internal parameters initialization of the instrument is started, and three seconds later, it switches to the following interface:

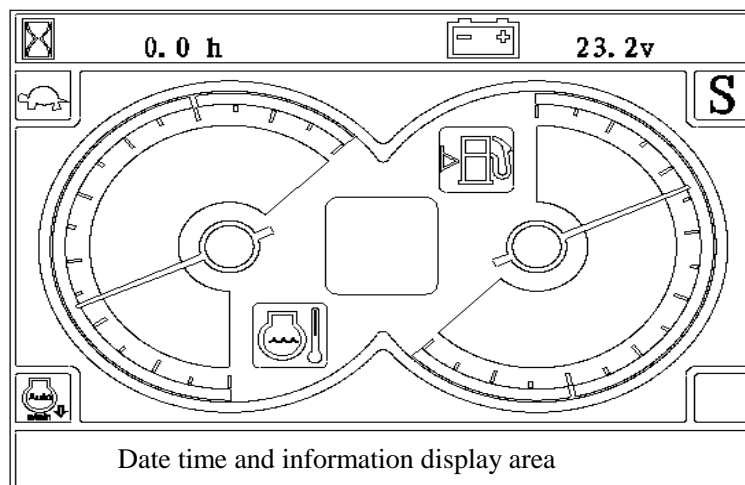

b) When the key switch is turned to ON, the interface of the instrument is as follows:

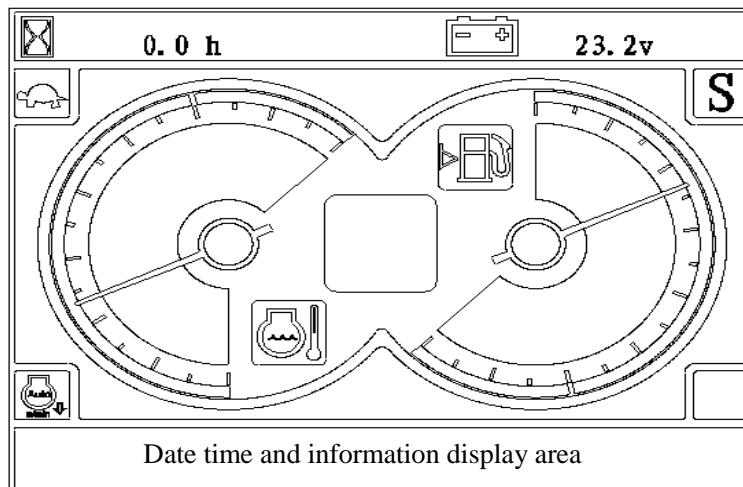

● Button instructions:

- a) , The two buttons are respectively corresponding to functions of the instruction area between positive display liquid crystal to realize power mode switch. The switch can be carried out in heavy load mode (H), simple load mode(S), light load mode (L) and pulverized load mode (P).
- b) The two buttons are respectively up key and down key when it comes to the menu, through which required information can be chosen.
- c) Automatic idle speed button : after the automatic idle speed button is pressed, there will be at lower left. Three seconds later, the controller pulls the pointer from the current throttle position to the idle speed position as follows:

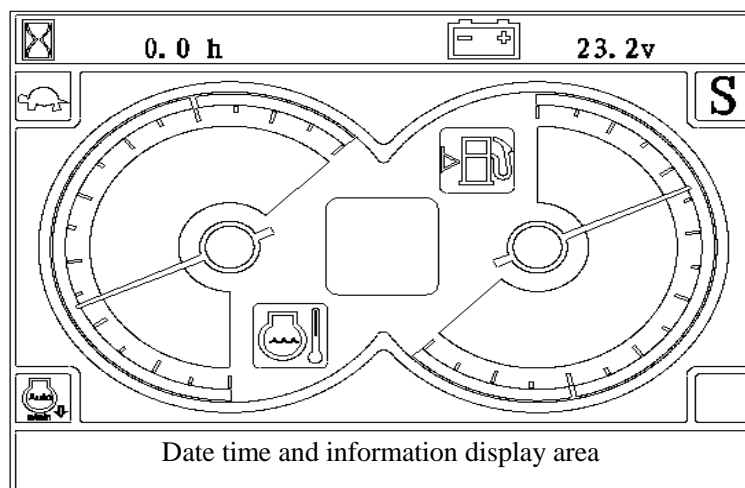

after the automatic idle speed button is pressed again, at the lower left disappears, and the controller automatically pulls the pointer from the idle speed position to the throttle position.

- d) High and low speed moving button after the key is pressed, the moving electromagnetic valve obtains electricity, which enables high speed moving of the machine, the icon will appear at the upper left, as shown in the following figure:

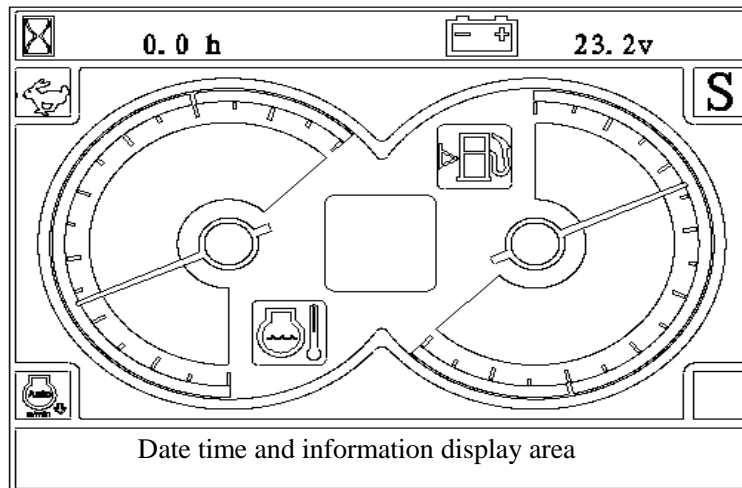

When the key is pressed again, the moving electromagnetic valve loses electricity, and the machine moves slowly. The interface is as follows:

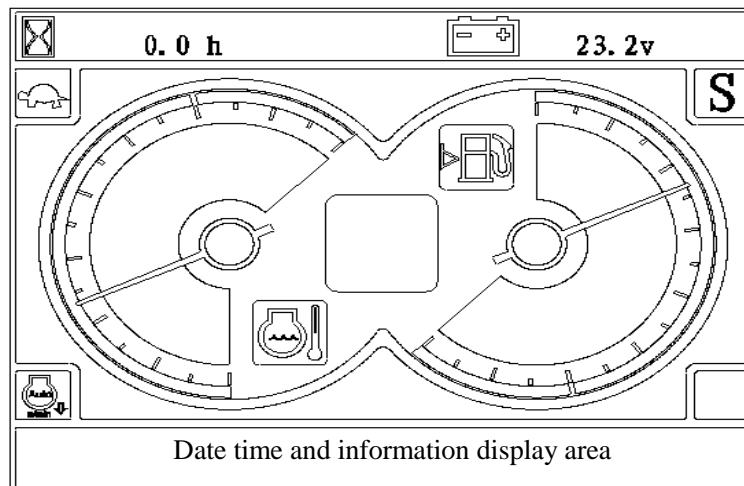

- Menu operating illustration (For use only as operation demonstration, which may be different from that of the machines):

a) Button operation in the working interface.

- When the menu key  is pressed in the working interface, the main menu interface is entered as follows:

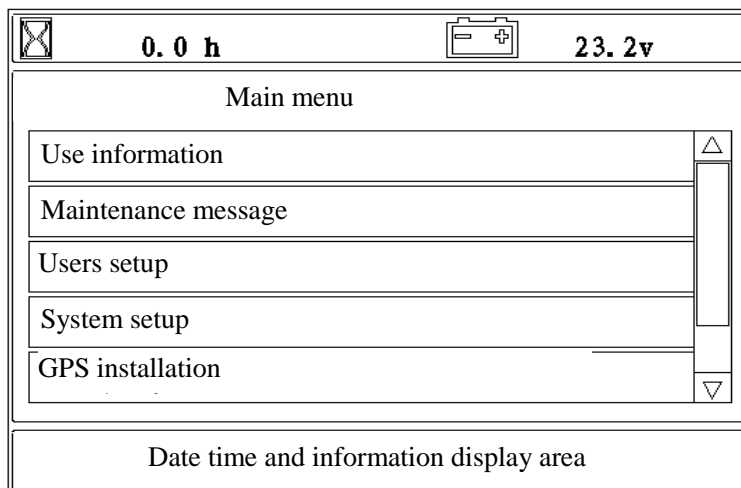



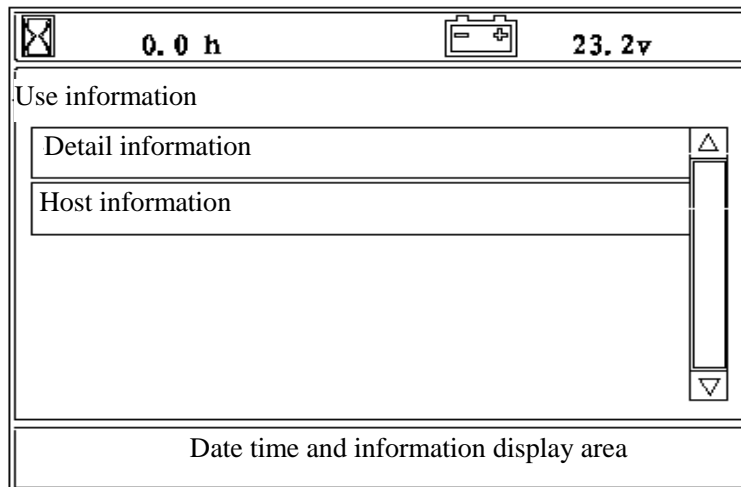

- Choose use information in the main menu and press the confirmation key , the use information menu is entered as follows:



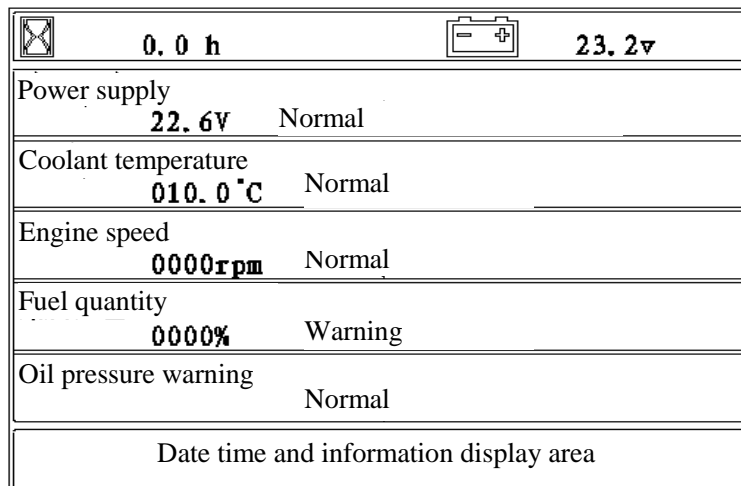

- Choose in the use information menu and press the confirmation key , specific information is shown as follows:

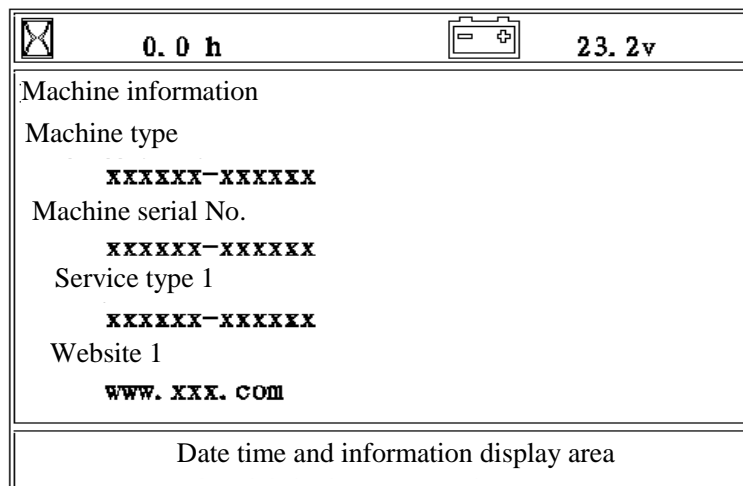

- Choose in the use information menu and press the confirmation key , host information is shown as follows:



- Choose in the main menu press the confirmation key , the maintenance information menu is entered, which shows maintenance details in each time period, and users can keep maintenance accurately and timely.
- Choose user setting in the main menu and press the confirmation key , the user setting menu is entered as follows:

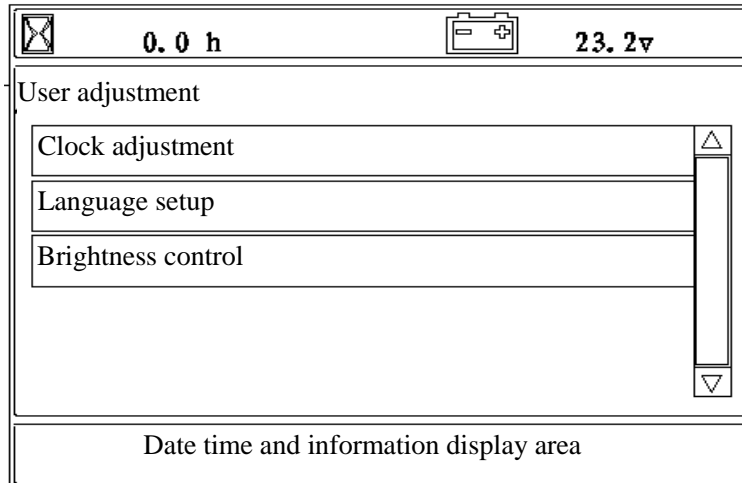

- Choose in the user setting menu and press the confirmation key , the clock adjustment menu is entered as follows:

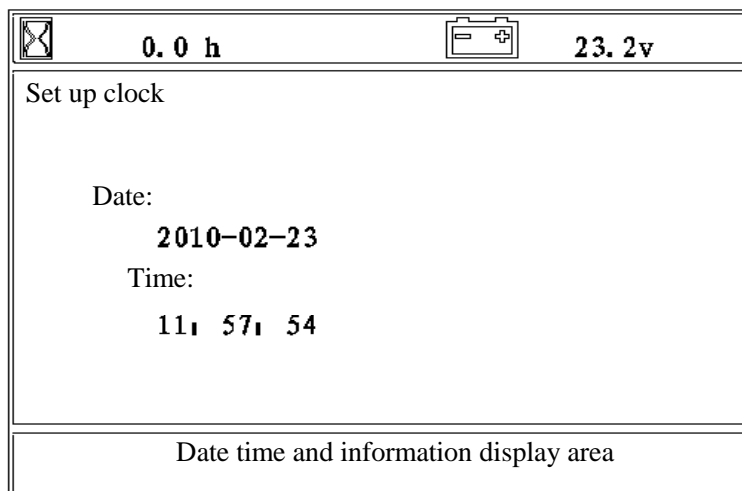

- Choose in the user setting menu and press the confirmation key , the clock adjustment menu is entered as follows:

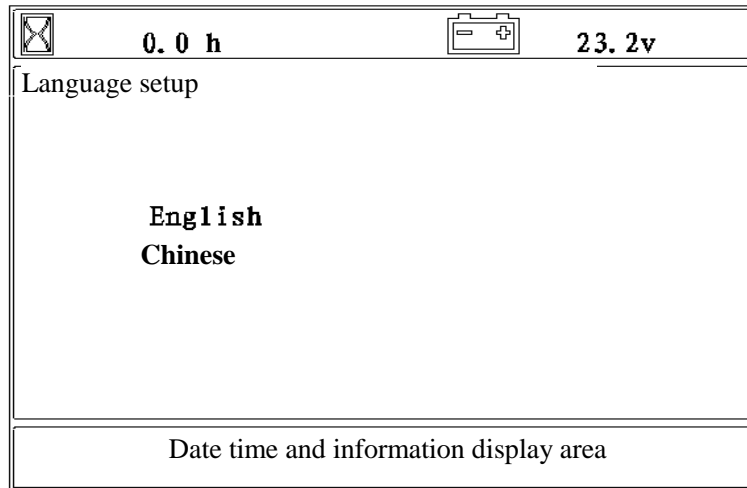

- Choose in the user setting menu and press the confirmation key , the language setting menu is entered as follows:

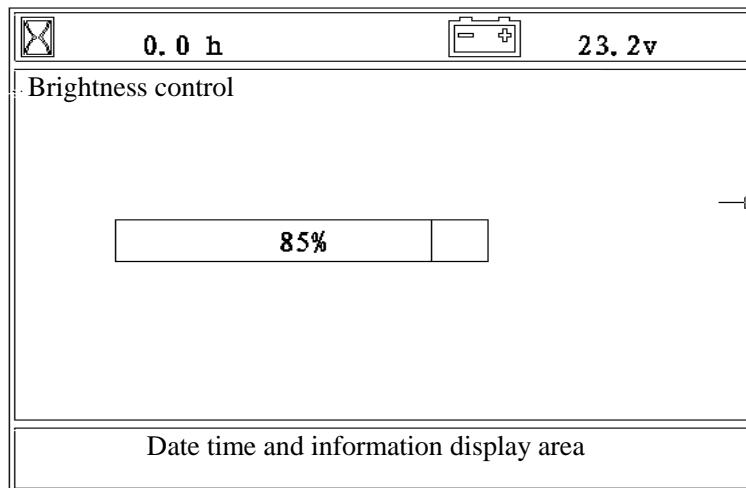

- Choose in the user setting menu and press the confirmation key , system setting use menu is entered as follows:

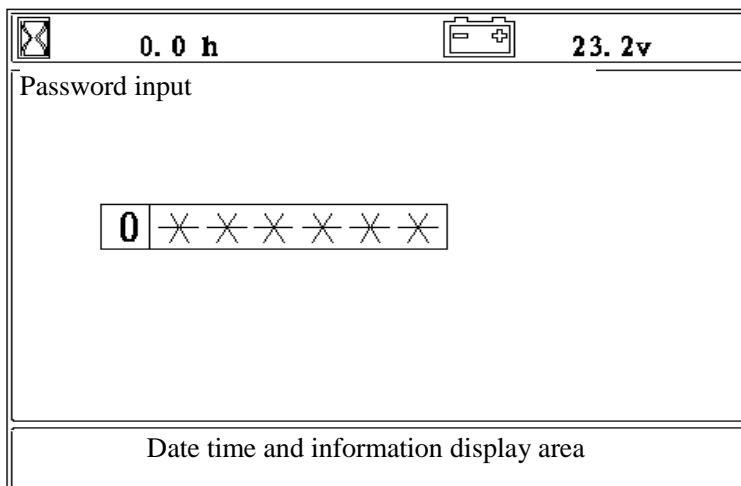

### Control panel of Air Conditioner

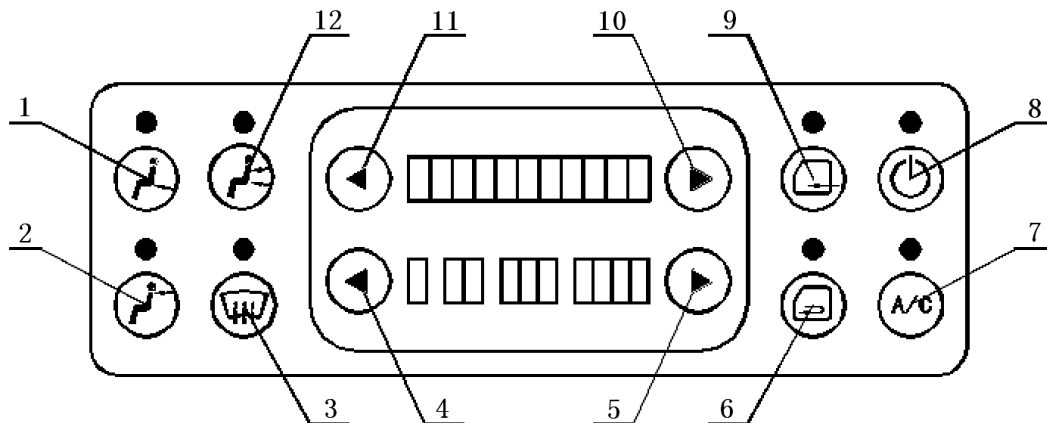

1. Control Button of Air-out (Foot direction)  
When this button is pressed, the motor of foot direction part of air conditioning unit is started and the ventilation door is opened to have the air blown out from the lower air duct.
2. Control Button of Air-out (Face direction)  
When this button is pressed, the motor of face direction part of air conditioning unit is started, the ventilation door is opened to have the air blown out from the upper air duct.
3. Control Button for Defrostation  
When this button is pressed, the warm air passes through the air duct and directly blows towards the window in front of the driver.
4. Air Volume Regulation Button (Small)  
When this button is pressed, the indicator light for air volume is on; the air volume shifts from high to low (the volume is from level 4 to 3, and from 2 to 1).
5. Air Volume Regulation Button (Large)  
When this button is pressed, the indicator light for air volume is on; the air volume shifts from low to high (the volume is from level 1 to 2, and from 3 to 4).
6. Control Switch for Internal Ventilation  
When this button is pressed, the fresh air motor of air conditioning unit is off while other motors are started, and then the air inside the cab is transmitted to the inner of the unit through evaporator blower, and then the air is transmitted into the cab by the evaporator blower to form ventilation.
7. Cooling Switch  
When this button is pressed, the cooling indicator is on and the air conditioning system is switched to the cooling mode.
8. Power Switch  
When this button is pressed, the indicator of control panel is on; the control panel is powered on, and the system is switched to operation mode.
9. Control Button for Fresh Air Ventilation  
When this button is pressed, the motor for fresh air of air conditioning unit motor starts, and then the fresh air from outside fills into the cab and fresh the stale air inside.
10. Temperature Adjustment Button (Large)  
When this button is pressed, the temperature indicator light is on, the temperature is adjusted from low to high; when it hits 30°C, the air-conditioning automatically converts from cold air to warm air.
11. Temperature Adjustment Button (Small)  
When this button is pressed, the temperature indicator light is on, and the temperature is adjusted from high to low.
12. Air Direction Control Button ( Face & Foot Direction )  
When this button is pressed, all motors of air conditioning unit is started to have the air blown out from the wind duct freely.

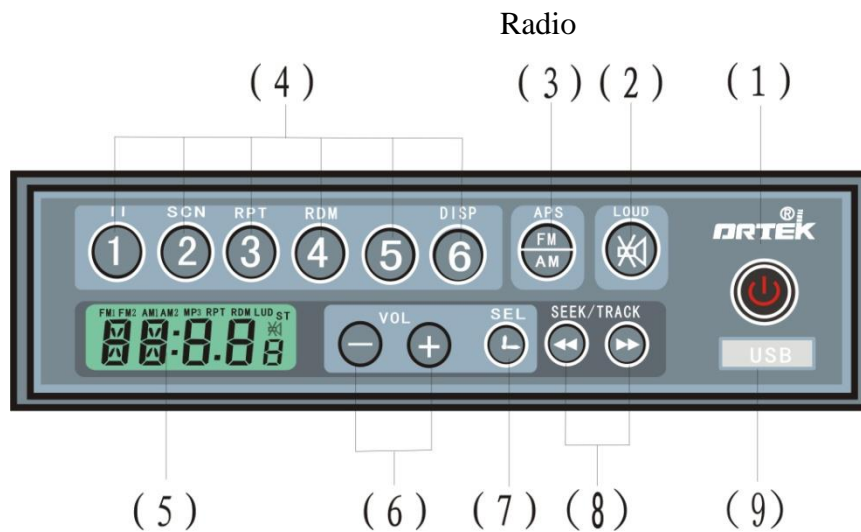

- (1) Power/mode switch
  - ◇ Press the button to switch on power; hold the button under the working state to turn off the radio.
  - ◇ When the radio is powered on, press the button to toggle between FM ⇄ MP3 (⇄ IN Optional). (Press: less than 2 sec.; hold: over 2 sec.)
- (2) Mute/Auto volume
  - ◇ Press to toggle mute on/off.
  - ◇ Hold to toggle auto volume on/off
- (3) Band switch/auto tuning
  - ◇ Press to switch among FM1/ FM2/AM1/ AM2.
  - ◇ Hold to detect and store new stations available in the preset
- (4) Preset Button
  - ◇ In FM mode, press to select preset station and hold to store station.
  - ◇ In MP3 mode,
    - <1/PAUSE> Pause/play.
    - <2/SCN> Scan/ normal play.
    - <3/RPT> Repeat/ normal play.
    - <4/RDM> Random/ normal play.
    - <6/DISP> Display track number/duration.
- (5) Screen
- (6) VOL+/- Volume
  - Press VOL+/- to turn up or down the volume.
- (7) SEL Effect/Time setting
  - ◇ Press to display time and date on screen; press within 5 seconds to view effect settings
  - ◇ In time display, hold to reset time
  - ◇ Display returns to screen information if no button is pressed within 5 seconds
- (8) ◀◀ / ▶▶ FM scan & MP3 file selection
  - ◇ In FM mode, press to change frequency forward or backward
  - ◇ In mp3 mode, press to select files
- (9) USB.

## Seat

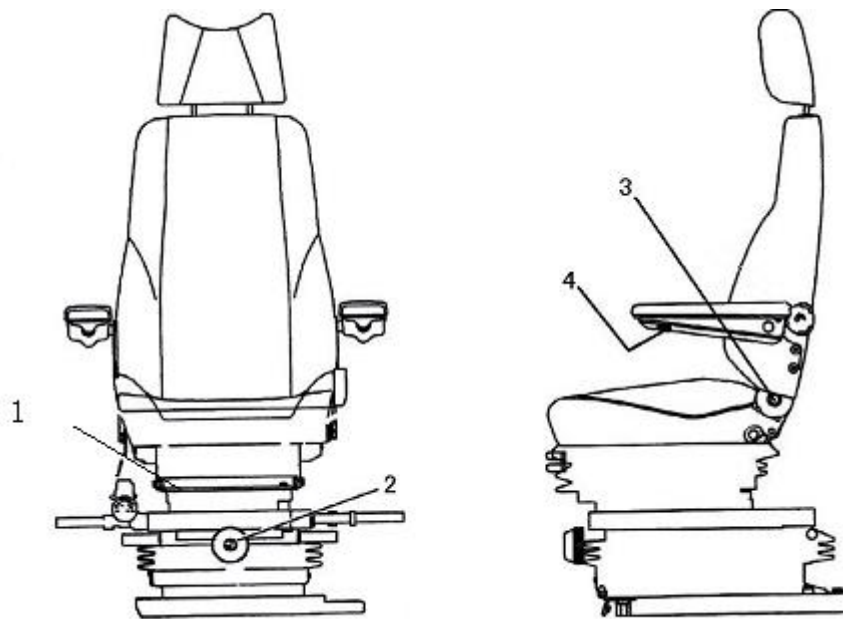

1. Adjustable back and forth  
3. Adjustable back cushion

2. Adjustable on weight  
4. Adjustable armrests

## Warning!

- The seat is designed for one person at a time.
- Do not adjust the seat during digging actions.
- Avoid moving objects.
- Assembly and maintenance should be performed by qualified personnel.

## Switches

### Lighting switch

Rocker Switch 1#

Press this switch (1 #), the illuminating lamps for the movable arm and the platform are turned on.

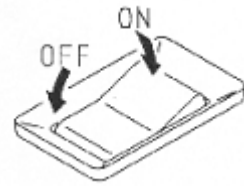

### Switch for the windshield wiper

Rocker Switch 2#.

Press this switch (2 #), the windshield wiper for the front glass swing continuously.

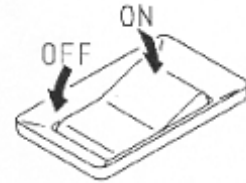

### Switch for the watching window wiper

Rocker Switch 3#.

Press this switch (3 #) continuously, the cleaning solution of the window is sprayed on the front glass, when releasing, spraying stops.

Water injection



### Switch for the background lights of the air conditioner and radio

Rocker Switch 4#.

Press this switch (4 #) continuously, the cleaning solution of the window is sprayed on the front glass, when releasing, spraying stops.

Turn on backlight

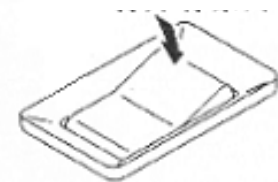

### Starting switch

The switch is use for starting or shutting down the engine.

#### OFF position

The key can be plugged in and pulled out. All of the switches of the electric system are closed. The engine is stopped.

#### ON position

When the engine is running, keep the key of the starting switch in the ON position.

#### START position.

This is the starting position for the engine. When starting the engine, keep the key in this position. After the engine is started, release the key immediately and the key will come back to the ON position automatically.

#### HEAT (preheating) position

When starting the engine in winter, adjust the key to this position. When the key is adjusted to the HEAT position, the preheating monitor is on. The key is in this position until the lamp of the monitor is shining. After the lamp of the preheating monitor is shining, release the key immediately and the key will come back to the OFF position automatically. And then turn the key to the START position and start the engine.

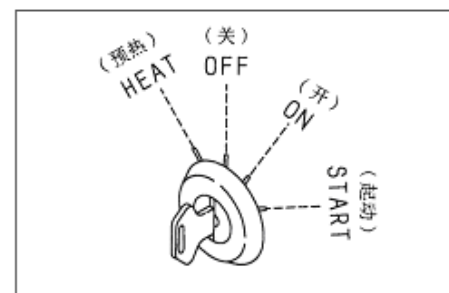

### Switch for the horn

When pressing the button switch on top of the operating lever of the right working device, and the horn honks.

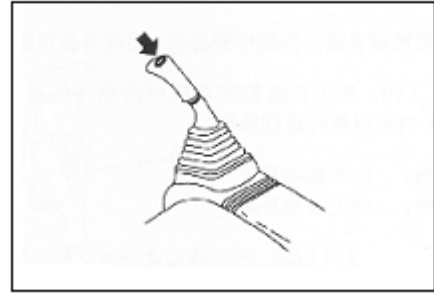

### Pressure-up switch

The button switch on the operating lever of the left working device is used to start the contact-mode strength function. As long as pressing the (click) switch, the hydraulic system pressure can be increased, which plays a role of increasing the power output of the excavator and the excavating force. But the maximum time to use the maximum power is 8 seconds to prevent damaging the hydraulic system.

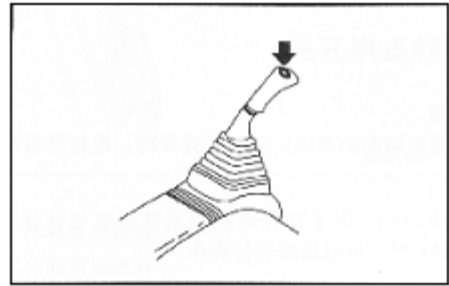



## Operation

### General principle

This machine can only be operated by those qualified, experienced operator with excavator operating certificate, who is allowed to inspect and maintain this machine. Pay attention to:

- Read carefully and command this book before the starting or the first operation of machine.
- This book should be placed accessible for the convenience of timely replacement or supplement when it is lost, damaged or unable to read.
- Careful check should be done before starting this machine. Use and operate it strictly according to the safety procedure.
- Immediate high-speed running is avoided for the engine started at low temperature. The normal working temperature for oil is 50°C~80°C, if it is below 25°C, warm-up running should be done so that the oil temperature can be raised to the required one for the operation.
- While the machine is transferred out of factory, there has been long-term rustproof and anti-freeze fluid in the radiator, which should be drained out totally to protect the machine from rust if the machine is stopped for a long time.
- Winter-use lubricant and diesel fuel should be used in cold winter. The brand is according to this book. For the cold-start of engine, please refer to operating manual of diesel engine and this book.
- When a refill is needed for the loss of hydraulic oil, make sure to use the identified clean hydraulic oil. Oil of different brand is forbidden.
- Pay attention to the cleanliness of hydraulic oil at any time. If it is aging, bad or not clean enough, be sure to replace it at once with the new oil. Normally a replacement happens after the running -in of new machine.
- The key parts of hydraulic system have been sealed by lead. During the warrant period, the seal can't be opened privately by the customer, or it won't be guaranteed.
- Before the delivery, the machine has been checked and adjusted strictly. But proper running-in must be gone through will using the machine, so that all parts can run in very well and the life span of the machine can be lengthen. The running-in period is 100 hours. For the first 50 hours, only L working mode namely weak excavating mode is allowed, also the engine power is limited within 80% of full load to run the machine. During this period, overdue idling is avoided, and all indicating meters should be checked. The machine should be maintained everyday to avoid of the oil leakage. At the first 50 hours or working in mud, pins should be lubricated once every 8 hours. After 50 hours, the torque of tighten parts should be checked and the maintenance be made for the machine. After 50 hours, new lubricant should be added for the diesel engine.

## Operating procedure

### Operating environment

### Operating lever

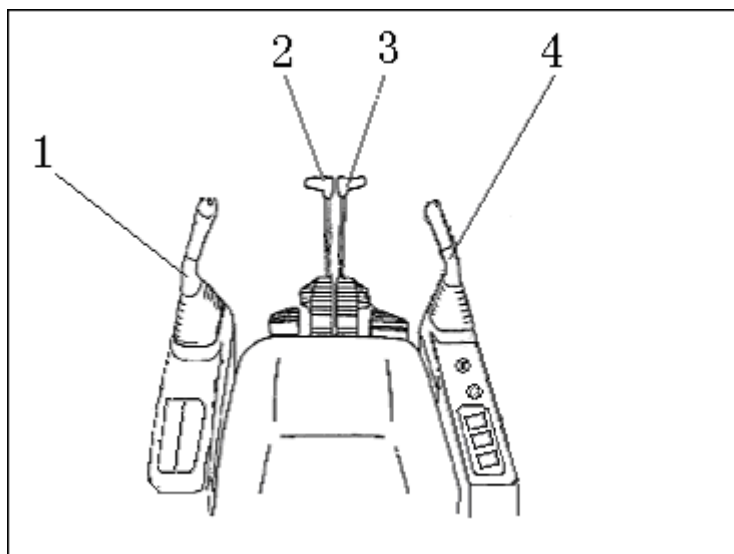

1. Left control handle

2. Left control handle for the crawler

3. Right control handle for the crawler

4. Right control handle

### Traveling pedal

### Warning!

- Except the machine moves, do not put your feet on the pedal, if you put your feet on the pedal and step by mistakes, the machine will move suddenly and cause serious accidents.
- When the track frame is installed towards the rear part, the machine will move in the reverse direction of moving forward and the heading direction of the reverse moving.  
When using the operating lever, check the track frame is towards the rear part or the front part. (If the chain wheel is in the rear part, then the track frame is towards the front part.)
- When using the pedal for operating and moving, special attention should be paid.

The operating levers (2, 3) are used to exchange the moving directions of the machine.

The operations for the pedal are described in ( ).

- (a) Moving forward: push the operating lever forward (the pedal will tilt forwards);
- (b) Reverse moving: pull the operating lever backwards (the pedal will tilt backwards);

N (middle position): the machine stops

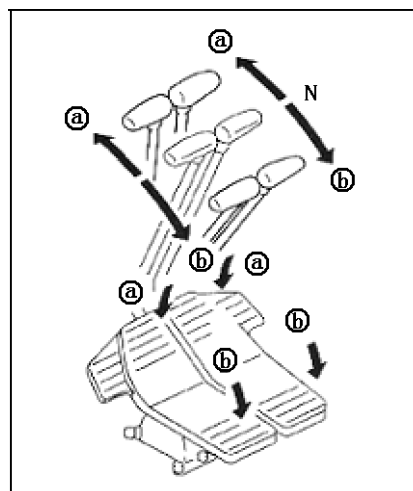

## Operating lever for the working device

The operating lever (1) of the left working device is used to operate the bucket rod and the rotation of the upper part of the machine.

- (a) Bucket rod unloading
- (b) Bucket rod excavating
- (c) Right rotation
- (d) Left rotation

N (middle position): the upper part of the machine and the bucket rod keep immovable.

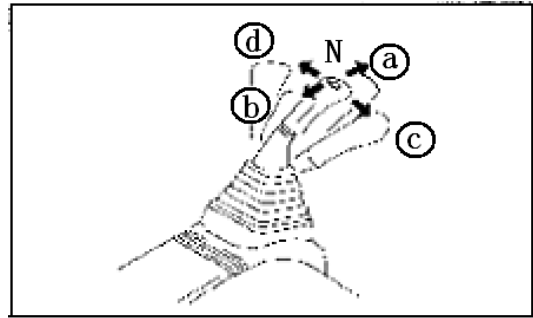

The operating lever (4) of the right working device is used to operate the movable arm and the scoop.

Movable arm operating/scoop operating

- (a) Movable arm lifting
- (b) Movable arm lowering down
- (c) Scoop unloading
- (d) Scoop excavating

N (middle position): the movable arm and the scoop keep immovable.

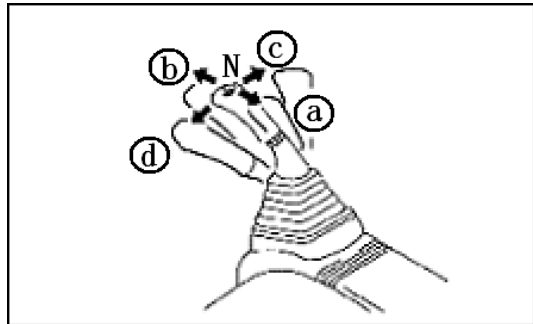

## Operation for the accumulator

### Warning !

The accumulator is filled with high pressure nitrogen, wrong operation may cause explosion and result in serious injury or damage. When operating the accumulator, the following steps must be followed:

- Control the pressure in the pipeline not to be discharged thoroughly, and do not stand in the direction of the oil spraying when dismantling the hydraulic devices, and loosen the bolts slowly.
- Do not dismantle the accumulator.
- Do not put the accumulator close to the open fire or expose in the fire.
- Do not drill holes or weld on the accumulator.
- Do not collide, roll or make the accumulator suffer from hit.
- When disposing the accumulator, the gas must be emitted. Please contact Xugong Excavator or its distributor

## Windows for the driver's cab



**Open the windows**

1. Put the auxiliary devices on the ground, and then shut down the engine.
2. Hold two handles (A), heave outwards and pull upwards, the front window can be opened.
3. Put the window in the locking position after opening them.



**Close the windows**

1. Put the auxiliary devices on the ground, and then shut down the engine.
2. Hold two handles (A), heave outwards and pull downwards, the front window can be closed.
3. Install the windows firmly and use the key to lock them.

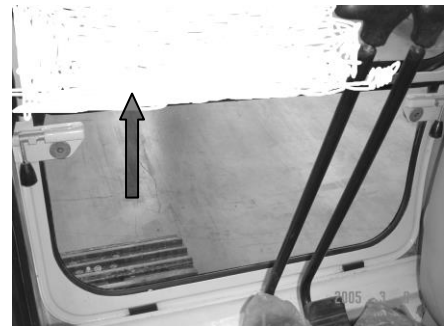

**Dismantle the front window**

1. For opening the front window, see the “open the windows”.
2. Hold the upper part with two hands and pull upwards.

Store the windows dismantled in the inner side behind the driver’ cab, which is shown as (B) in the right graph.

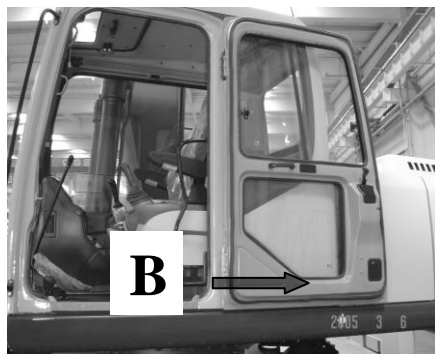

**Locking system for the driver’ cab**

**It is used to operate the door of the driver’ cab to be in open state.**

1. The operator pushes the door of the driver’ cab out of the driver’ cab.
2. Ensure the door of the driver’ cab is fixed on the lock (C) firmly.  
Press the handle (D) in the driver’ cab of the operator, release

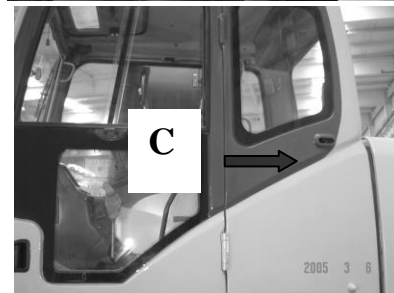

**the door of the driver’ cab.**

Fire extinguisher and emergency exit  
 Fire extinguisher (optional part)  
 The fire extinguisher is installed on the two bolts (E) in the right and rear side of the driver’ cab.  
 Use the fire extinguisher when fire alarming.

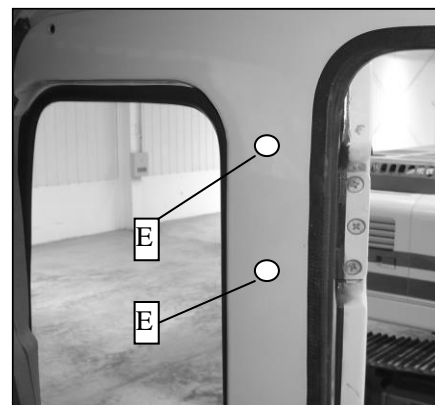

Emergency exit  
 When emergency, use the emergency escape hammer (G).  
 There are two emergency exits---the door and the rear window. Whether the rear window is fixed mode or sliding mode, the emergency escape hammer hung in the rear side in the driver’ cab to crush the glass.  
 F---rear window  
 G---emergency escape hammer  
 H---door

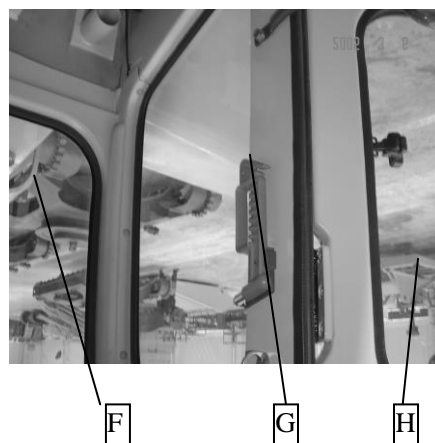

**The preparation and operation of starting**

● **Follow the safety regulation**

- a) Read carefully and abide by all the safety signs as well as all the safety-related information in this book.
- b) If necessary, please install, maintain or replace safety signs.
- c) If safety signs or this book are lost or damaged, please order the new ones from appointed dealer in the same way of purchasing other parts (type and delivery number of the machine must be written clearly).
- d) Learn how to operate the machine correctly and safely. Only those operators qualified after the training are allowed to operate and maintain the machine.
- e) While carrying out the operation and maintenance, all the safety rules, warnings and requirements must be strictly followed.
- f) Keep the machine under proper working condition. Any modification unapproved may spoil the function or safety of the machine; even shorten its life span.
- g) Safety indications are the basic regulation for the safe of the machine. However, they won't involve you into any kind of danger that you may run into. If there is some question, please report to your higher-up at first before operating or maintaining this machine.
- h) You can't operate this machine in the case of bad health, weariness due to the medicine or unease in the environment, which will reduce your response towards the contingency and lead to the accident.
- i) While working with other driver or traffic keeper on the spot, it is necessary to ensure the hand language and working environment are familiar to all the personnel.
- j) Please keep an eye on all the factors affecting safety at any time.



Fig.1-31

● **Take precautions against the emergency**

Guard against the happening of fire disaster or any accident.

- a) Install first-aid kit and fire extinguisher nearby.
- b) Read carefully and understand the information on the fire extinguisher, user it correctly.
- c) To ensure the fire extinguisher can always be used in emergency, regularly maintain it according to the recommended maintenance interval in operational manual of fire extinguisher.
- d) Map out the emergency countermeasure guidance to cope with fire disaster or accident.
- e) Attach the phone numbers of doctors, ambulance, hospital and fire department near the phone.



Fig.1-32

● **Notice for the inside the cab**

- a) While entering the cab, you should first remove the mud and oil on the sole, or you may slip when stepping on the pedal and be trapped into an accident.
- b) After using the ashtray, at first you should check if the match and cigarette have been placed in order, and then shut the cover of ashtray to avoid of a fire disaster.
- c) Don't stick a couple on the window glass, which can serve as a lens and cause a fire disaster.

- d) Don't put the lighter in the cab casually, which may explode if the temperature in the cab is very high.
- e) To ensure the safety, don't wear earphone to tune in the radio or music to avoid of a severe accident.
- f) When operating, don't extend you hand or head out of the window.
- g) When you need to stand on the seat, make sure the safe locking lever is locked. If not, with the careless touch on the lever, the equipment will move suddenly and cause a accident.
- h) While leaving the machine, you should lower it to the ground, lock safe locking lever, stop the engine, lock all the equipment with key and withdraw the key to keep it always with you.

● **Wear working clothes and individual protection outfit**

- a) Wear tight clothes and safety products suitable for the work.

You may need the following safety products:

Hard safety helmet

Safety shoes

Safety glasses, goggles and mask

Thick gloves

Hearing protector

Glistening clothes

Rain wheel

Respirator or filtration mask



Fig.1-33

When working, you must wear working clothes and safety products without taking your chance.

- b) Fix the long hair, avoid of wearing large clothes, ornaments or other things, which will hook on to control lever or other parts of the machine and cause the casualty.
- c) Don't wear clothes full of oil stains, for it is flammable.
- d) Make sure to wear goggles, head helmet, safety shoes and gloves.
- e) While repairing the equipment, don't use tool of weak strength, because it is easy to be broken or slippery, leading to injury or incompetent installment.
- f) Don't ignore those factors without immediate danger to your health, such as exhaust gas and noise pollution, which, though invisible, may breed disability or permanent injury.
- g) Being in big noise for a long time may result in the injury or loss of your hearing.

Wear proper hearing protector like earcap or earplug to avoid of harmful or uncomfortable big noise.



Fig.1-34

● **Inside ventilation**

Engine's exhaustion will cause fatal casualty, making people lose consciousness, vigilance, judging and controlling ability, even leading to a severe accident.

- a) Before starting the engine in closed area, please confirm good ventilation.
- b) Beware the opening door or window, where exhaust gas may enter or be blown in by wind, leading to the danger.



Fig.1-35

● **Check the machine**

- a) To avoid of the injury on people, check the machine before starting it everyday or in every shift.

Repeated inspection surrounding the machine should be done in earnest.

- b) While doing the repeated check, it is necessary to check all the items described latter in “checking the engine before the start”.

- **Investigate the construction site beforehand**

When working near the ditch or on the road shoulder, the machine is possible to roll over, causing a severe casualty.

- a) Investigate the land form and floor condition of construction site beforehand, such as ground, material heap and other place easy to collapse to prevent the machine from turning over.
- b) Map out working schedule, use machine suitable to work or construction site.
- c) Reinforce the ground, ditch side or road shoulder according to the requirement, so that certain distance is kept between the machine and ditch side or road shoulder.
- d) When working on slope or road shoulder, employ a signaler according to the demand.
- e) While working where some blocks or gravel may fall off, ensure that the FOPS (FALLING OBJECTS PROTECTION SYSTEM) is equipped in the cab.
- f) When the groundwork turns soft, reinforcement on ground should be implemented before the work.
- g) While working on icy surface, you should be alert specially, for the going-up of environment temperature will make the groundwork soft and slippery.
- h) When operating the machine beside some flammable things like dry grass, pay more attention to the possibility of catching the fire.



Fig.1-36

- **Normal notice for the cab**

- a) While entering the cab, the operator should first remove the mud and oil on the sole, or he may slip when stepping on the pedal and be trapped into a accident.
- b) Don't surround the seat with parts and tools, which should be placed according to the regulation.
- c) Try to avoid of placing transparent bottles in the cab and don't hang any transparent ornaments around the window glass, for they man focus the sunlight and result in a fire disaster.
- d) During the operation on machine, don't tune in the radio or use earphone or mobile phone etc.
- e) Don't put any flammable or explosive objects in the cab.
- f) After using the ashtray, always cover it to put out the match and cigarette or so. Don't leave a lighter inside the cab, because it may explode when the temperature in the cab goes up.



**The preparation and operation of starting**

● **Adjust the seat**

Any seat position unsuitable to the operator or operation will lead to the fatigue of the operator very soon even an operational error.

- a) Every time when changing the operator, the seat should be adjusted again.



Fig.1-37

When the operator leans against the back of seat, he should be able to push the pedal to the bottom and operate the control lever correctly.

- b) If he can not, he can move the seat up and down, to and fro, and make a second adjustment.

● **Buckle the safety belt**

In the case of turning over a machine, the operator may be injured or thrown out of the cab, even crushed by the machine being turning over, trapped into a severe casualty.

- a) Before the operation, the operator should check carefully the belt, buckle and tightening parts. If there is any damage Or wear and tear, he should replace the belt or its components.
- b) During the running of machine, the operator must always be sitting on tl belt perfectly to minimize the possibility of injury from an accident.
- c) However the belt is safety, it is better to be renewed once every 3 years.



Fig.1-38

● **Operating only when the operator is on the seat**

- a) Incorrect starting procedure of engine may cause a severe casualty.
- b) Start the engine only when the operator is on the seat.
- c) Make sure not to stand on crawler or ground to start the engine.
- d) Don't starts the engine through short-circuit starting motor terminal.
- e) Before starting the engine, confirm all the control levers are in middle position.



Fig.1-39

● **Check the machine before starting the engine**

- a) Electric control system: check if there is any worn or broken electrical wire or loosen connector.
- b) Don't starts the engine through short-circuit starting motor terminal.
- c) Before starting the engine, confirm all the control levers are in middle position.
- d) Structural parts and crawler: Check moving arm, bucket and metal sheet etc; check if the crawler has bending, damaged or lost parts.
- e) Tightening parts: Check if there is loose or lost part.
- f) Fuel system: Drain off water or deposit from fuel tank.
- g) Hydraulic system: check if there is leakage, hose distortion and friction mutually between pipe and hose or between pipe and other parts.
- h) lubrication: Check the lubrication points mentioned in lubrication schedule.
- i) Protection mechanism: Check protection mechanism and mudguard.

- j) safety: Keep all the people away from the machine and remove the obstacle.
- **Check the cab before starting the engine**
  - a) Confirm the safe locking lever in LOCK position and all the control levers in middle position.
  - b) Check the indication of indicator: if the key switches turned to START position, charge warning and oil pressure for the engine will be indicated, meanwhile the machine will automatically check if preheat and warm-up are needed. If there is the need, preheat indicator will flash, if a warm-up is needed, warm-up indicator will be on.

**Important: monitor will show the operational condition of the machine. If the indicator has some malfunction during the work of machine, it will only have warning sound rather than indication. So, if some malfunction is happened on the indication of indicator, an immediate check and repair is needed. After the check, if indicating lamps for engine oil pressure and alternator don't flash and the warning doesn't sound, it means the machine is abnormal and needs an immediate repair.**

- c) Adjust the seat. It is better for the operator to step the pedal to the bottom while leaning



Note: To avoid of damaging the surface of monitor, while cleaning the monitor or switch, it is advisable that cloth is used rather than sharp objects like screwdriver, since they will spoil the screen of monitor.

- **Start the engine**
  - a) Pull the safe locking lever to LOCK position.
  - b) Turn the engine speed knob to low-speed idle position.
  - c) Press the horn to remind the surrounding people.
  - d) Turn the key switch to START position.

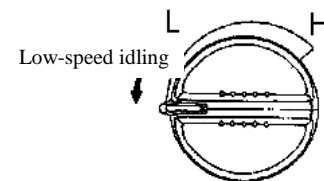

Fig.1-42

**Important: prevent the damage on starting motor.**

**To avoid of the damage on starting motor, it is advisable that 10 seconds should not be exceeded to operate the starting switch every time. If the engine still can't be started, the key switch should be turned to OFF position for a restart after another 30 seconds. After the failure in starting the engine, if the key switch is turned for a restart before the starting motor stops, the starting motor will be damaged.**

- e) After starting the engine, key should be able to return to POWER position after the release.

- **Start and warm up the engine in cold weather**

- a) Preheat must be carried out when starting the engine in cold weather.
  - 1) Turn the engine speed knob to the almost middle position between L (LOW) and H (HIGH).
  - 2) Turn the key switch to START position.
  - 3) The machine will automatically check if preheat is needed, if so, preheat indicator will be on for about 8 seconds when the engine can not be started



Note: If preheat indicator does not show, it means preheat is not necessary.

- 4) As the preheat indicator goes out, turn the key switch to START position again, and release it as soon as the engine is started.
- b) Warm up the engine after the start.

**Important: the best working temperature for hydraulic oil is 50°C~80°C. If the temperature is below 30°C, overwork of the machine will damage it and hydraulic parts seriously. Before the work, the hydraulic oil should be heated up to 25°C. Before the completion of warm-up operation, it is forbidden to operate the control lever or increase engine speed suddenly. Don't let the engine run continuously for over 20 min. at the idling or high speed.**

- 1) After the start of engine, the machine will automatically check if a warm-up is needed for the engine, if so, warm-up indicator will be on.



Note: if warm-up indicator does not shine, it means the warm—up is not needed.

- 2) At this moment, the bucket and bucket lever can be operated by turns in full stroke for 5 min. with the interval of 30 seconds.
- 3) When the hydraulic oil temperature reaches the required value, warm-up indicator will go out showing the completion of warming up the engine.
- 4) After heating the hydraulic oil, increase the engine speed and begin working.

**Important: operate the machine at lower load and speed until the engine and hydraulic system have a normal temperature.**

● **Check after the start of engine**

- a) Check or engine's water temperature and oil pressure, as well as fuel level on all meters, indicators or monitors, to see if they are normal.
- b) If the following indicators on the monitor continue to shine or the sound and exhaustion of engine are not normal after the engine is started, the engine must be stopped immediately to remove the cause. After starting the engine, the following should be confirmed:
  - 1) Indicator of alternator goes out.
  - 2) Oil pressure indicator of engine goes out.
  - 3) Sound and exhaustion of engine are normal.
  - c) Check the level meter on hydraulic oil tank to see if oil level is within the regulated range.
  - d) Check if fuel, oil or cooling fluid leak out.

**Important: prevent the engine from possible damage.**

**Operation procedure of running**

- Confirm the treading direction of machine  
Operational errors on treading pedal and control lever will lead to a severe casualty.  
Before driving this machine, confirm the relation between the positions of machine’s low body and the operator.

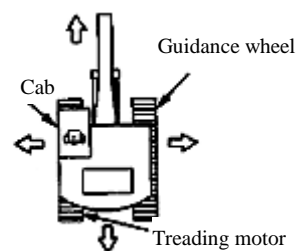

If the treading motor is in the front of cab, the machine will move backward when the treading pedal or control lever is pushed forward.

**⚠ Caution: the standard treading position is: guiding wheel is in the front of the machine, while treading motor and driving wheel at the rear. If the treading motor is in the front, the treading pedal will function in reverse. Before treading, it is a must to confirm the position of treading motor.**

 Note: at the side of chassis bodyframe, there is an arrow sign indicating the front direction of machine.

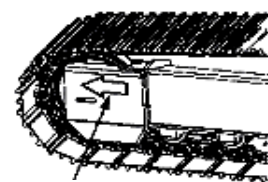

Arrow  
Fig.1-45

- **Prevent the machine from carrying the passengers.**
  - a) The passengers are easy to be wounded on the machine, for example, hit by foreign object or cast away by the machine.
  - b) Only the driver rather than other passenger is allowed to be on the machine.
  - c) Sometimes the passenger will block the view of driver, leading to the operation of machine under unsafe condition.



Fig.1-46

- **Use pedal to drive the machine**
  - a) travel forward: Step down the front of two pedals (A in picture).
  - b) travel backward: Step down the rear of two pedals (B in picture).
  - c) Middle position: When treading pedal is in middle position(C in picture), the machine will be braked by treading brake.

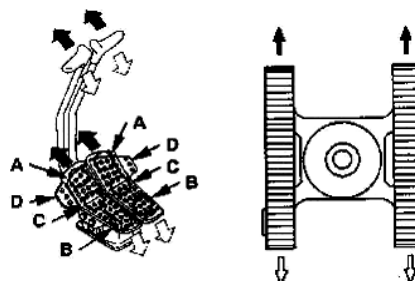

Forward and backward

Fig.1-47

- d) Turn right: step down the front of left pedal.
- e) Turn left: step down the front of right pedal.
- f) Rotate at the original position (self-rotation): step down the front of one pedal and the rear of another one.

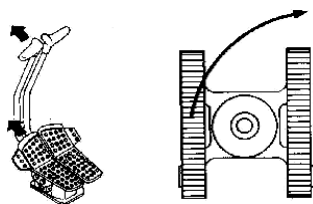

(Turn right)  
Fig.1-48

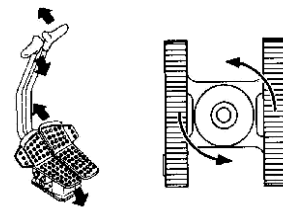

(Rotate at original point)  
Fig.1-49

 **Note:** during a long journey, you can relax your feet by stepping on continuously the protruding part of pedal (D in picture). To achieve the smooth operation, a damper has been installed on treading guidance valve. When the weather is cold, operational force will be increased. At this time, you can operate first the treading control lever for several times when the safe locking lever is at LOCK position.

● **Drive the machine through treading control lever**

- a) Travel forward: push forward two treading control levers (A in picture).
- b) Travel backward: pull backward two treading control levers (B in picture).
- c) Middle position: when treading control lever is in middle position(C in picture), the machine will be braked by treading brake.
- d) Turn right: push forward the left treading control lever.
- e) Turn left: push forward the right treading control lever.
- f) Rotate at the original position (self-rotation): push forward one treading control lever while pull another one.

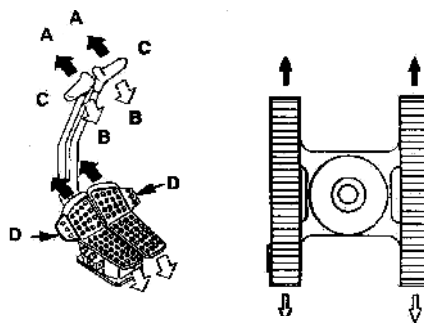

(Forward and backward)

Fig.1-50

● **Switch of treading mode**

 **Caution:** since rolling over of the vehicle will result in the casualty, so don't change the treading mode frequently, especially during the downgrade. Changing to a fast mode will produce a very severe result. Remember to stop the machine before changing the treading speed.

You can choose treading mode (fast/slow) through the switch of treading mode on monitor, which will give you the following two choices by turns with every press.

- a) Fast: indication is on.
- b) Slow: indicator is off.



sign (fast)



Fig.1-51

1—switch of treading mode  
2—fast-speed indicator

● Notes on travel

**⚠ Note: when moving, rotating or operating the machine in narrow area, one signaler is sure to be employed. Before starting the machine, hand signs should be coordinated.**

- a) Before moving the machine, the operator should be clear how to operate the treading pedal/control lever towards the desired direction. When treading motor is at the rear, the machine will move forward in the direction of guidance wheel by stepping down the front of treading pedal or pushing forward the treading control lever.
- b) Try to choose level ground and drive the machine in straight line, change the direction slowly and slightly.
- c) Before the travel, check the strength of bridge and groundwork, reinforce them if necessary.
- d) To avoid of damage on road surface, it is advisable to use wooden board. When treading on pitch road in summer, pay more attention to the drive.
- e) When crossing the rail, it is advisable to use wooden board to avoid of damage on road surface.
- f) Don't let the machine contact with the edge of bridge.
- g) When crossing the river, the operator should measure the depth of river with bucket and cross the river slowly. Don't cross the river when the water exceeds the top edge of supporting-chain wheel.
- h) When treading on uneven ground, engine speed should be decreased and the slow treading mode should be chosen to reduce the possibility of damage on the machine.
- i) Don't travel across some obstruction, such as mud block, stone and metallic objects around the machine. While running, other people are not allowed to stay around the machine.
- j) When running on slope, the machine may skid or turn over, causing some severe injury or even death.
- k) When upgrading or downgrading, bucket should be placed in the direction of treading with a distance of 0.2-0.3 meters from the ground (see A in the picture below).



Fig.1-52



Fig.1-53

- l) If the machine begins to skid or becomes unstable, the bucket must be lowered immediately.
- m) Crossing the slope sideling or changing the direction may lead to the danger of side-slipping or turning over the machine, for the moment, it is better to travel safely through a detour after landing on even ground

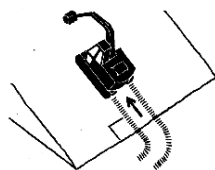

Fig.1-54

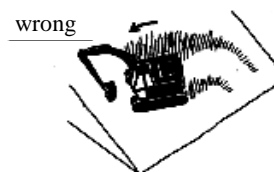

Fig.1-55

- n) Try to avoid of the operation, which may damage the crawler and lower machine parts.

- o) In frozen weather, before loading and unloading the machine, make sure to remove the deposited snow and ice on crawler board to guard against the slip.
- Operation on soft land
  - a) Avoid running on very soft ground when there is no enough strength to support the machine.
  - b) If the machine works on very soft ground or gets trapped, it is necessary to clean the chassis bodyframe.
  - c) One side of crawler should be lifted away from the ground by rotating the lower machine body by 90° and lowering down the bucket, the angle between the moving arm and bucket lever should be kept 90°~110°, and the arc part of bucket should be placed on ground.
  - d) Remove the mud on crawler board by lifting the crawler with front and rear rotating arms.
  - e) After landing the crawler, the treading speed should be lowered and the machine should be transferred to solid ground with care.
  - f) Operate the moving arm to coordinate with the bucket lever, tow the machine to solid ground.
  - g) If the machine gets trapped but the engine remains working, towing the machine is possible but must be done with towing rope equipped correctly (refer to the following part of “towing the machine in short distance”).

● **Lift single-side crawler with moving arm and bucket lever**

**⚠ Caution: the angle between the moving arm and bucket lever should be kept 90°~110°, and the arc part of bucket should be placed on ground.**

Crawler should be lifted away from the ground by rotating the lower machine body by 90° and lowering down the bucket. The wedge should be placed under the chassis bodyframe to support the machine.

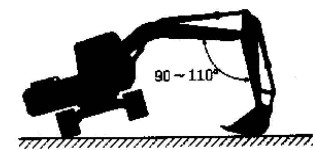

Fig.1-56

● **Tow the machine is short distance**

**⚠ Caution: it is possible that steel cable, strap or rope will be broken and cause a serious casualty, so damaged chain and worn steel cable, hook, strap or rope must not be used to tow the machine. When dealing with steel cable, strap or rope, the gloves must be worn all the time.**

When the machine fails to run but the engine can be operated, please connect the towing steel cable and tow your machine to solid ground by other machine according to the picture. You must fix the steel cable on chassis bodyframe of two machines.

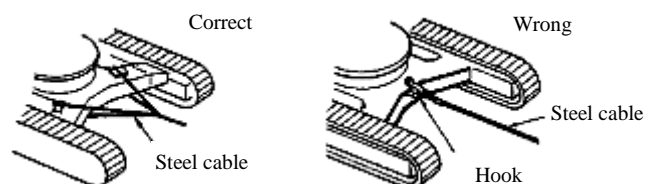

Fig.1-57

To avoid the steel cable being worn out and broken, put some protection material between the chassis bodyframe and steel cable.

**Important: don't tow the machine through hook hole on chassis bodyframe, this hole is**

only for towing light-weight object.(refer to the introduction about how to use hook hole correctly).

● **Operate in water or mud**

- a) Only when the groundwork of construction site is strong enough to prevent the going-down of machine from exceeding the upper edge of supporting-chain wheel, is the machine allowed to be operated in water whose surface is below the upper edge of supporting-chain wheel (An in picture below).
- b) When operating under such condition, you should check the position of machine frequently, if necessary, readjust it.
- c) Try to prevent water from submerging the rotary support, small rotary gear and central connector.
- d) If the rotary support, small rotary gear and central connector are submerged, you should dismantle the drain plug to remove mud and water, cleaning rotary area, putting on the plug, lubricating the small rotary gear and rotary support.
- e) The capacity of gear oil of rotary gearbox: B.
- f) Lubricate the rotary support (refer to the instruction of lubrication, maintenance and repair).



Fig.1-58

List 1-7 Parameter List

Parameter Type	A	B
XE210C	770 mm	14 L
XE210C3VII	770 mm	14 L
XE210C2	770 mm	14 L
XE210C2VII	770 mm	14 L



### Operation of cutoff

- The procedure of stopping the engine
  - a) Land the machine on even ground.
  - b) Lower the bucket down the ground.
  - c) Turn the engine speed knob to low-speed idling position and run the engine for 5 min. to cool it.



Fig.1-59

**Important: if the procedure of stopping the engine is incorrect, turbocharger may be damaged.**

- d) Turn the key switch to OFF position and stop the engine.
- e) Withdraw the key from key switch.
- f) Pull the safe locking lever to LOCK position.

**Important: in bad weather, make sure to protect internal electric parts in the cab. When parking the machine, always shut the windows, roofhatch and the door.**

- g) Shut the window and cab door.
  - h) Lock all the maintenance hatches and compartments.
- **The procedure of engine's emergency cutoff (optional attachment)**

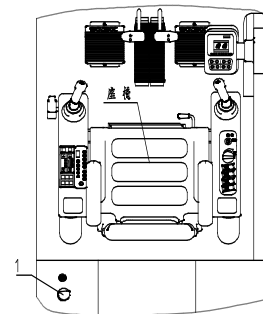

Fig.1-60

1 — Emergency cutoff button

- a) Land the machine on even ground.
- b) Lower the bucket down to the ground.
- c) Press the emergency cutoff button and stop the engine.

**Important: Normally being forbidden, this mode is used to stop the engine only there is some big danger involving the person and equipment.**

- d) Turn the key switch to OFF position and stop the engine.
- e) Withdraw the key from key switch.
- f) Pull the safe locking lever to LOCK position.

- **Prevent the machine from causing the injury**

If you try to climb on or block the moving machine you may expect a serious casualty. To prevent the machine from out of control, you should:

- a) Try to choose even ground when parking the machine.
- b) Don't park the machine on slope.



Fig.1-61

- **Park the machine on slope**

**⚠ Caution: avoid parking the machine on slope, for it may roll over and lead to the person injury.**

If you want to park the machine on slope, you should:

- a) Park it with proper distance away from other machine.
- b) Lower the bucket and (or) other working equipments down to the ground.
- c) Insert the bucket teeth into ground, position the machine perfectly and prevent it from rolling by supporting the crawlers on both sides with stop blocks.

- d) Without load, run the engine 5 min. at low idling speed to cool the engine.
- e) Stop the engine and withdraw the key from switch.
- f) Pull the safe locking lever to LOCK position.
- g) Shut the windows and cab door.
- h) Lock all the maintenance hatches and compartments.

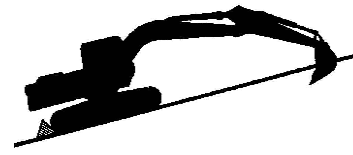

Fig.1-62

### Getting on and off the machine

#### ● Use railing and ladder

Falling off is one of the major causes for person's Injury. When getting on or off the machine, make sure to keep three touching points (two feet and one hand or two hands and one foot) with railing, pedal and crawler all the time, facing the machine.



Fig.1-63

- a) Before getting on or off the machine, you should clean and dry the oil, butter, mud or sand on railing, board or crawler immediately if they exist, then keep these parts clean. If some part is damaged, you should repair it and tighten the loose screw.
- b) When getting on or off the machine, don't grip the control lever.
- c) Don't jump on or off the machine, especially those moving one, for these behaviors may make you suffered from injury.
- d) While leaving the machine, pay attention to the slippery platform, ladder or railing.

Operating procedure

● Control lever

**⚠ Caution:** Don't extend any part of your body out of the right window frame of the cab. If touching the right control lever due to careless collision or other reason, you may be injured by moving arm. If some window is lost or broken, you should add or replace into a new one. Before the operation, you should know very well the position and function of every control lever to prevent yourself from injuring by accidental movement of the machine.

**Important:** don't let hydraulic cylinder of moving arm contact with the crawler. When excavating near one end of the crawler, you should place the treading motor at the rear to maximize the machine stability and lifting ability.

On the machine, there is a scutcheon indicating the control mode of control lever and treading pedal. After being released, the control lever will return to the middle position automatically followed by the stop of the machine.

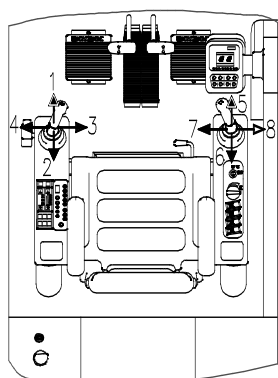

Fig.1-64

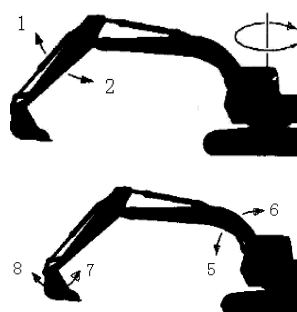

Fig.1-65

List 1-8 List of illustrated signs

Serial number	Function
1	Bucket lever protrudes
2	Bucket lever withdraws
3	Turn right
4	Turn left
5	Moving arm goes down
6	Moving arm goes up
7	Bucket excavates
8	Bucket unloads

● Safe locking lever

When leaving or entering into the cab, the operator may touch the control lever accidentally, this can be prevented by safe locking lever.

**⚠ Caution:**

- 1) Always pull the safe locking lever to full LOCK position, or it won't function.
- 2) When leaving the machine, stop the engine and then pull the safe locking lever to full LOCK position.

3) Always verify the following cases to ensure safe locking lever has been pulled to LOCK position.

When transporting the machine;

**When leaving the machine after the duty.**

The operation of safe locking lever:

- a) Before leaving the machine:
  - 1) Place it on level ground, lower the bucket on ground, return all the control levers to middle position and shut off the engine correctly.
  - 2) Pull the safe locking lever to full LOCK position.
- b) Before starting the engine, confirm that safe locking lever is located at LOCK.
- c) After starting the engine, confirm that all the control levers and pedals are in middle position and there is no movement in all parts of machine, then lower the safe locking lever to release position.
- d) When all the control levers are in middle position, lower the safe locking lever to release position, if some part of machine moves, it means there is a failure. At this moment, you should pull the safe locking lever back to LOCK position and stop the engine. Then you can carry out a repair or contact with appointed dealer.

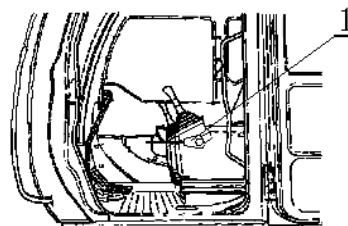

Fig.1-66

1 — safe locking lever

● **Engine's speed control**

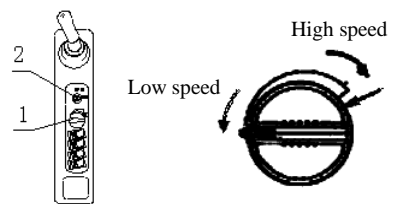

Fig.1-67

1 — knob of engine speed 2 — key switch

According to this picture, increase or decrease engine speed through engine speed knob on right control box,

- a) Increase engine speed by turning the engine speed knob clockwise; on the contrary, decrease engine speed by turning the engine speed knob counter-clockwise.
- b) Before stopping the engine, always turn the engine speed knob counter-clockwise to the bottom (low-speed idling setting), run the engine for 5 min. to cool it, then turn the key switch to OFF position to stop the engine.



Note: in every working mode, the highest speed of engine can only reach the max. one designed by this mode.

● **Self-idling speed**

In self-idling state, if all the control levers return to middle position, then after about 4 seconds,

Engine speed will reduce to designed self-idling speed to save the fuel consumption. If any control lever is operated, engine speed will immediately increase to the designed one on engine speed knob.

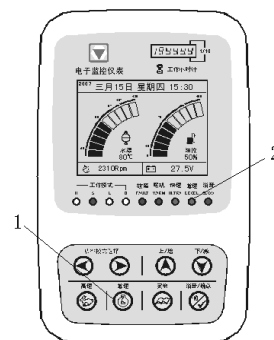

Fig.1-68

1 — button of canceling self idling

2 — self idling indicator

**⚠ Attention:** always verify the brightness of self-idling indicator before the operation. If it is on, showing the self-idling is functioning.

- a) Self-idling function is on: self-idling indicator is on.
- b) Self-idling function is off: self-idling indicator goes out.
- c) When self-idling function is on, it can be released by pressing the button of canceling self-idling.
- d) When restarting the engine, self-idling function will restore.

● **Boost**

Boosting switch is at the top of right control lever, it can be used to get the max. excavating force. By pressing this switch, working machine will achieve a boosted force of about 8 seconds.

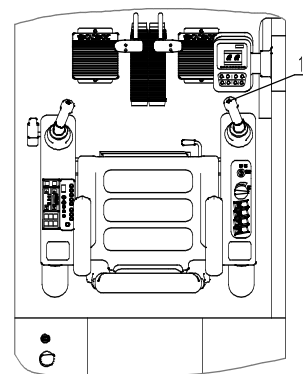

Fig.1-69

1 — Boosting switch

● **Working mode**

through working mode switch, one of the following 4 modes namely H、S、L、B can be chosen for work.

- a) Mode S (standard excavating mode)

It can save fuel consumption best and should be adopted in normal work. When it works, mode S indicator shines.

- b) Mode L (weak excavating mode and mode of leveling up ground )

In this mode, engine speed may be reduced, but excavation force remains the same with mode S. although the output is little less than that of mode S, but the fuel consumption and noise have been reduced for the machine to do some light-duty work such as leveling up ground. In this mode, indicator of mode L shines.

- c) Mode H (strong excavating mode)

It is suitable for excavating hard ground in short time. It can give full play the max. power of engine to enhance the working efficiency. When this mode works, indicator for mode H is on.

- d) Mode B (knapping hammer mode)

It is suitable for the work of hydraulic knapping hammer. When this mode works, indicator for mode B is on.

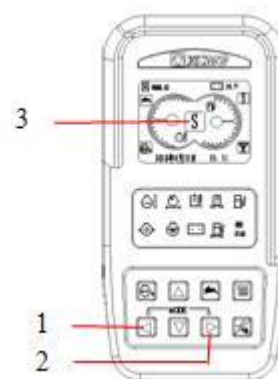

Fig.1-70

1、2 — working mode button

3 — mode-H indicator

**Important:** if the machine is equipped with knapping hammer, then this mode must be adopted or the

machine will be damaged.



Note: after the start of machine, the default working mode is S.

● **Operation of counter-shoveling**

- a) Let the bottom of bucket be 45°with ground, and place the bucket teeth on ground.
- b) Take the bucket lever as a main excavation force to pull the bucket towards the machine.
- c) When the soil is attached on bucket, dump away The soil in a way of moving bucket lever and (or) bucket to and fro quickly.
- d) When digging a straight ditch, place the crawlers parallel with the ditch. When the desired depth is reached, move the machine and continue the digging according to the demand.

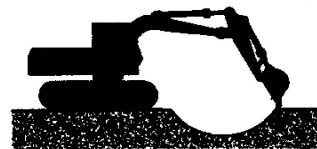

Fig.1-71

**Important:** 1) a sudden stop should be avoided when lowering the moving arm or the machine may be spoiled by the impact.2) when using the bucket lever, it should be avoided to stretch the hydraulic cylinder of bucket lever fully, so that the cylinder won't be damaged.3) when digging in one angle, bucket teeth should be avoided to collide with the crawler.4) when digging a deep ditch, you should prevent the moving arm or hose of bucket's hydraulic cylinder from knocking on the ground.

● **Operation to level up the ground**

**Important:** don't push the soil with bucket while treading.

When you need to level up the earth, put the bucket Lever a litter further from the vertical position like that in the picture. When turning the bucket back and lifting the moving arm slowly, you should operate the bucket lever's withdrawing function, so that when the lever is beyond the vertical position, the bucket can maintain stable horizontal movement by lowering down the moving arm slowly. The work of leveling up the earth can be more accurate by operating the moving arm, bucket lever and bucket synchronously.

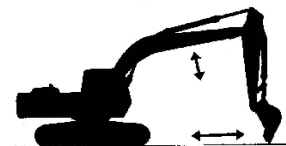

Fig.1-72

● **Operational technology**

- a) Don't treat the treading as an additional digging force, or the machine will be destroyed.



Fig.1-73

- b) Don't lift up the rear of machine body and treat the body weight as an additional digging force, or the machine will be destroyed.



Fig.1-74



Fig.1-75

- c) When digging, don't let the bucket knock the crawler. Try to place the machine on level ground, don't use the bucket as a hammer or pile driver, and don't try to move stone or crash wall through rotation.

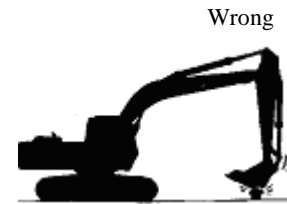

Fig.1-76

**Important: to avoid the damage on hydraulic cylinder, don't knock or harden the ground with bucket when the hydraulic cylinder of bucket stretches fully (the bucket withdraws fully).**

- d) Every time, adjust the length and depth of excavation so that every digging can achieve a full bucket, which will yield more than that made by fast cycle of partly filling bucket. To improve the productivity, full-bucket should be the first target, followed by speed.
- e) Once the ditch is opened, the stone can be dug out and pulled upward the bucket from the soil layer. It can be achieved by lifting one or two layers, the top layer is pulled out at first. Don't let the bucket bear the side load and level up the material by rotating the bucket or knock with the object with the bucket from the side.

**Important: don't try to extend the bucket lever fully and abandon the bucket, don't penetrate the ground with bucket teeth to dig out the stone, which will lead to serious damage on machine.**

- f) When the machine is driven out of the water, the incline angle of machine should be less than 15°. Don't submerge the machine into water whose surface is over permitted depth (normal water depth should not exceed the upper edge of supporting-chain wheel). For those parts soaked in water for a long time, they must be lubricated with butter till the old butter is squeezed out of the lubrication point.

● **Choose suitable crawler board**

**Important: the crawler board may bend and (or) the screws may loose also other debarkation parts may be demolished by using wide crawler board on uneven ground.**

Don't use wide crawler board on uneven ground full of rock, sand pile or gravel. Wide crawler board is designed for soft ground, its screw should be checked on fixation regularly.

● **Use hook hole**

One hook hole is made on chassis bodyframe to tow the object whose weight is listed in the table below.

**Important: while using hook hole on chassis bodyframe, the following limitation and notices must be identified, or the chassis bodyframe and (or) hook hole may be destroyed.**

- a) The max. towing force is: A.



List 1-9 Parameter list

Machine type	A
XE210C	73600N(7.5T)
XE210C3VII	73600N(7.5T)
XE210C2	73600N(7.5T)
XE210C2VII	73600N(7.5T)

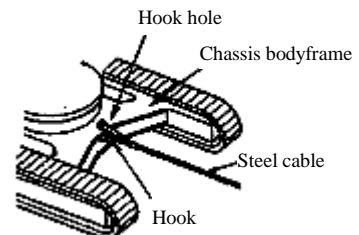

Fig.1-77

- b) Hook must be used.
- c) Make sure that steel cable is towed horizontally and in the same direction of crawler.
- d) Choose slow treading mode, drive the machine slowly when towing.

● **Pay attention when stopping the machine and staying overnight**

- a) After finishing the duty of that day, drive the machine to the place where there is no falling stone, ground collapse or flood, then park the machine on solid and level ground.
- b) Top up the fuel tank
- c) Clean the machine.
- d) In winter, if there is no anti-freeze fluid or cooling fluid with long lifespan, make sure to drain off cooling water in radiator and engine. After that, you must also hang up the plate of “no water in radiator” in visible plate.

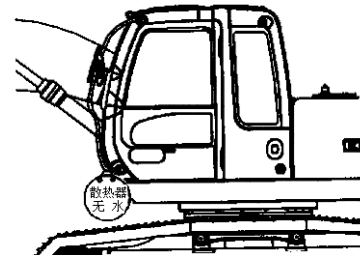

Fig.1-78

● **Notes for the work**

⚠ **Attention: check working site beforehand**

- 1) **When working on site where some object may drop, you must install a roof protector for cab.**
- 2) **If it is needed to work on soft land, the ground should be fully hardened in advance.**

- a) When working on the machine, you must wear tight clothes and other safety products like safety helmet, which are suitable for work.
- b) Let other person go out of the moving range of the operation and the machine, clean all the obstruction. During the operation, you should pay attention to the surrounding all the time, and don't let the boarding run into obstruction when working in small area surrounded by obstruction.

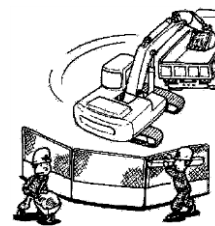

Fig.1-79

- c) While loading the material for the truck, you should lift the bucket above the truck bucket from the rear of the truck, try not to rotate the bucket above the cab or anyone.
- d) When operating, fence should be installed at the side and rear of the bucket's rotating radius to prevent any unconcerned person enter into the working area.

● **Operate the machine safety**

⚠ **Attention: Prevent the machine from rolling over and influenced by ground collapse.**

Pay attention to the followings:

- a) Ensure the work site is strong enough to support the machine hardly. When working in ditch or road shoulder, operate the machine by making the crawler vertical to the wall and the treading motor at the

rear. In this way, even the wall collapses, the machine can withdraw easily.

- b) If it is necessary to work on cliff or under high bank, make sure to check working site at first and confirm there is no possibility that cliff or bank will collapse, if there is, don't work in this area.
- c) When working on soft land, the ground may collapse leading to the rolling over of the machine. When you need to work on soft land, you must strengthen the ground at first with big steel board to support the machine.
- d) When operating on uneven ground or slope, try to prevent the happening of turning over your machine:
  - 1) Reduce the engine speed.
  - 2) Choose slow treading mode.
  - 3) Operate the machine slowly and pay attention to the movement of machine.



Fig.1-80

● **Guard against the falling of stones or gravels**

When working in the place where there may be falling stones or gravels, make sure FOPS(FALLING OBJECT PROTECTION SYSTEM)cab is contained in the machine.

● **Move or operate the machine safely**

When moving or operating the machine, the surrounding people may be knocked down. So pay attention to:

- a) Pay special attention not to knock down the people around. Before moving, turning or operating the machine, identify the position of those people.



Fig.1-81

Always keep the treading annunciator and horn in working state (if there are). When the machine begins to move, they can warn the surrounding people. When the machine is treading, rotating or being operated, the signaler should be employed and coordinate the hand signs with others before starting the machine.

● **Unified signals in multi-machine work**

In the case of multi-machine work, the signal known by all the working staff must be used. One signaler should be appointed to organize the operation to ensure all the people follow the command of this signaler.



Fig.1-82

● **Prevent the reversing and injury suffered from rotation**

When reversing or rotating the upper machine body, if someone is near the machine, he will be knocked down or crushed, suffered from a severe casualty.

To guard against the reversing and rotating accident:

- a) Before reversing or rotating, confirm there is nobody around the machine.
- b) Keep the treading annunciator and horn in working state (if there are). Always look out if there is other person entering into working area. Before moving the machine, please warn others with horn or other signals.
- c) When reversing, if your view is blocked, please use a signaler, always keeping



Fig.1-83



Fig.1-84

him in your visual field and using the hand signs in accordance with local rules.

- d) Only when the signaller and operator understand the signals very well, can the machine be moved.
- e) Understand the meaning of all the banners, signals and signs used in the work and confirm who should be responsible for issuing the signals.
- f) Keep the window, rearview mirror and lamps clean and perfect.
- g) Dust, heavy rain and fog will reduce the visibility, if the visibility is low, please decrease the speed and use proper illumination.
- h) Read and understand all the operational procedure in this book.

● **Don't place the bucket above anyone**

It is forbidden to lift, move or rotate the bucket above anyone or truck cab. Falling material from bucket or running into other bucket may lead to the serious injury on people or damage on machine.



Fig.1-85

● **Guard against the undercut**

To withdraw from the ditch side in case of collapsing groundwork, always keep the treading motor at the rear and the lower machine body vertical to the ditch side to place the machine.

When the groundwork begins to collapse and the machine can't be withdrawn, don't get nervous. Instead, you should fix the machine by lowering down the working equipments.



Fig.1-86

● **Avoid turning over the vehicle**

Don't try to jump out of tipping machine, or you will be suffered from serious or fatal crush since the inclining speed of machine is faster than yours. Buckle your safety belt when working.

- a) The danger of turning over always exists when operating on slope, leading to a severe casualty accident.
- b) To prevent from turning over, be specially careful when working on slope:

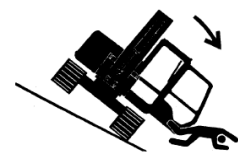

Fig.1-87

- 1) In work area of leveling up.
- 2) Lower the bucket down to the ground and keep it near to the machine.
- 3) Decrease the operational speed to guard against turning over the vehicle or skidding.
- 4) When treading on slope, avoid changing the direction.
- 5) If crossing the slope is a must, also you must not cross one whose gradient is over 15°.
- 6) When rotating the load, decrease the rotating speed according to the situation.

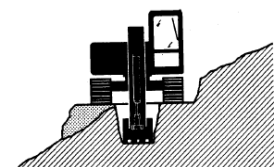

Fig.1-88

- c) Look our when working on icy ground, since the going up of temperature will make the land soft and unstable for treading on ground.

- **You mustn't undercut a high bank**

Undercutting a high bank may lead to the collapse of edge or landslide, causing a severe casualty.

- **Dig with care**

Accidentally cutting off underground electric cable or gas pipe may lead to a explosion or fire, causing a severe casualty.

- a) Before the excavation, check the position of electric cables, gas pipes and water pipes.
- b) Keep a legal min. distance with electric cables, gas pipes and water pipes.
- c) If optical fiber cable is cut off due to the accident, Don't look at the end of cable which otherwise may lead to serious wound in your eyes.
- d) Please contact directly with local related department, ask them to mark out the position of all the underground cables and pipes.



Fig.1-89



Fig.1-90

**Operation under special conditions**

● **Attention on operation**

- a) If the front working equipments of machine or other part collide with high objects such as overpass, both the machine and overpass will be damaged even the person will be injured.
- b) Look out to prevent the moving arm or bucket lever from bumping with high object.



Fig.1-91

● **Avoid the electric wires**

- a) If there is no safe distance between the machine or working equipments with electric wires, a casualty accident may be resulted from an electric shock.
- b) When working near high-voltage wires, don't move any part of machine or load into a range, namely 3 meters away from electric wire plus double length of insulator.
- c) Verify and follow all the local regulations in point.
- d) Wet ground will increase the electric shock range for the people, so the surrounding people should be far away from working area.



Fig.1-92

● **Drive the machine prudently**

**Important: in cold weather, you must park your machine on hard ground to avoid the crawler frozen with ground. Remove the oddments on crawlers and chassis bodyframe. If the crawler has been frozen with ground, lift the crawler with moving arm and bucket lever and move the machine with care to avoid destroying the driving wheel and crawlers.**

- a) Try to choose even road surface, make all the efforts to operate the machine and change the direction through straight line and slight change.
- b) When driving on uneven area, engine speed should be decreased to lower the possibility of damaging the lower machine body.

**Filling procedure of fuel, hydraulic oil, lubricant and anti-freeze fluid**

● **Fuel system**

- a) Recommended fuel brand

List 1-10 Fuel brand list

Time and area	Fuel products
Non-winter	0#( Above 4℃)
Winter	-10# (Above -5℃)
Frigid area	-35# (Above -29℃)

- b) Capacity of fuel tank

List 1-11 Capacity list

Type	Capacity of fuel tank
XE210C	380 L
XE210C3VII	380 L
XE210C2	380 L
XE210C2VII	380L

**c) Refilling method**

- 1) Park the machine on even ground.
- 2) Lower the bucket on the ground.
- 3) Run the engine for 5 min. at low-speed idling speed without load.
- 4) Turn off the engine; withdraw the key from key switch.

**Important: if the procedure of shutting the engine is not right, the turbocharger may be damaged.**

- 5) Pull the safe locking lever to LOCK.



**Attention: deal with fuel with prudence. Before adding the fuel, engine must be shut off. No smoking when the fuel tank is refilled or when fuel system is working.**

- 6) Check level meter of fuel or fuel meter on monitor, add new fuel if necessary.

**Important: prevent any dirt, dust, water or other foreign things into fuel system.**

- 7) To prevent from condensation, fuel tank should be refilled after the completion of operation everyday. Be careful not to splash the fuel on machine or ground. While refilling, regulated capacity should not be exceeded.
- 8) After the refill, replace the oil inlet cap on fuel tank to avoid losing or damage.

● **Hydraulic system**

- a) Recommended hydraulic brand and name List 1-12 brand and name list of hydraulic oil

Supplier	-20~15°C	-10~40°C
Xugong	Special hydraulic oil used for Xugong excavator (32 <sup>#</sup> )	Special hydraulic oil used for Xugong excavator (46 <sup>#</sup> )
Shell petroleum	Tellus oil 32	Tellus oil 46
Mobil petroleum	DTE 24	DTE 25
Remark	Anti-abrasion hydraulic oil	

- b) Capacity of hydraulic oil tank

List 1-13 Capacity list of hydraulic oil tank

Machine type	Capacity of oil tank
XE210C/ XE210C3VII	240 L
XE210C2/ XE210C2VII	240 L

● **Engine oil**

- a) Recommended engine oil brand and name

List 1-14 Brand and name list of engine oil

Supplier	-20~30°C	20~40°C
Xugong	Special hydraulic oil used for Xugong excavator	
	SAE10W/30	SAE15W/40
Shell petroleum	Rimula Super	
	SAE10W/30	SAE15W/40
Mobil petroleum	Mobil Delvac	
	SAE10W/30	SAE15W/40
Remark	API CF grade	

- b) Refilling quantity  
XE series: XE210C/ XE210C3VII/ XE210C2/ XE210C2VII are 25 L

● **Driving equipment**

- a) Gear oil brand and name recommended

List 1-15 Gear oil brand and name list

Supplier	-20~40°C	
	Travel reducer	Swing reducer
Xugong	Special hydraulic oil used for Xugong excavator(90 <sup>#</sup> )	Special hydraulic oil used for Xugong excavator (140 <sup>#</sup> )
Shell petroleum	Shell Spirax EP90	Shell Spirax EP140
Mobil petroleum	Mobilube GX90	Mobilube GX140
Remark	API GL-4 grade	

- b) Refilling capacity

List 1-16 Capacity list

Parameter Machine type	Travel reducer	Swing reducer
XE210C	6.8LX2	6.2L
XE210C3VII	6.8LX2	6.2L
XE210C2	6.8LX2	6.2L
XE210C	6.8LX2	6.2L

● **Cooling system**

- a) Recommended cooling fluid:

List 1-17 Capacity list

Supplier	-20~30°C	-10~40°C
Xugong	Special coolant used for Xugong excavator (30 <sup>#</sup> )	Special coolant used for Xugong excavator (45 <sup>#</sup> )
Shell	OTA-30	OTA-45

- b) Capacity of cooling liquid

List 1-18 Capacity list

Parameter Machine type	Anti-freeze fluid	Antirust fluid
XE210C	23 L	0.46 L
XE210C3VII	23 L	0.46 L
XE210C2	23 L	0.46 L
XE210C2VII	23L	0.46L

- c) Pay attention when preparing cooling fluid by the customer himself:

- 1) Cooling water: Putting soft and pure water or bottled water in radiator.
- 2) Antirust fluid: While changing cooling fluid, you should add antirust fluid whose capacity refers to list1-18, into new cooling fluid. Antirust fluid in not needed when using anti-freeze fluid.
- 3) Anti-freeze fluid: if the temperature is predicted to be below 0°C, the cooling system should be added

with the mixed fluid composing of anti-freeze fluid and soft water. The mixing rate of anti-freeze fluid refers to List 1-19, normally between 30% and 50%. If the rate is less than 30%, the system will be rusted; if the rate is over 50%, engine will be overheated.

d) Mixing rate list of anti-freeze fluid

List 1-19 Parameter list

Temperature	Mixing rate	Mixing capacity	
		Anti-freeze fluid	Soft water
℃	%	L	L
-1	30	6.9	16.1
-4	30	6.9	16.1
-7	30	6.9	16.1
-11	30	6.9	16.1
-15	35	8.1	14.9
-20	40	9.2	13.8
-25	45	10.4	12.6
-30	50	11.5	11.5



**Attention:**

- 1) **Anti-freeze fluid is poisonous. If taken in, it will result in a severe casualty accident. Once drinking it by mistake, the patient should be channeled off to vomit and obtain an immediate emergent treatment.**
- 2) **While storing anti-freeze fluid, make sure to store it in a container with sealing cap and remarkable mark. Always keep it away from the contact with children.**
- 3) **If anti-freeze fluid is splashed into eyes carelessly, you should wash your eyes with water for 10-15 min. and then seek out an emergent treatment.**
- 4) **When storing or abandoning anti-freeze fluid, you must abide by all the local regulations.**



### Safe operating procedure against fire

#### ● Treat the liquid safely

- a) Handle the fuel with care, since it is highly flammable. If fuel is ignited, it will explode and cause a fire and person's casualty.
  - 1) When smoking or being near the spark or burning object, don't add fuel to the machine.
  - 2) Before refilling, you must stop the engine.
  - 3) Refill the fuel outdoors.
  - 4) Static electricity can produce spark at the fuel inlet.
- b) When the weather is cold and dry or there is possible static electricity, always keep fuel inlet contact with fuel supply pipe to guarantee a good earth.
  - a) All the fuel, majority of lubricant and some cooling agents are flammable.
    - 1) Store the flammable liquid away from where there is fire danger.
    - 2) Don't burn or pierce pressured container.
    - 3) Don't save oil-contained rag, which can be ignited or burning automatically.
    - 4) Tighten the cover of fuel tank or other liquid tank, it is forbidden to start the equipment before tightening.



Fig.1-93

#### ● Guard against a fire disaster

- a) Check leakage: the leakage of fuel, hydraulic oil and lubricant may lead to a fire disaster.
  - 1) Check the loss or loose of pipe clamps, the distortion of hoses, mutual friction between pipes and hoses, the damage on fuel cooler and the loose of flange screw of fuel cooler to avoid the leakage.
  - 2) Tighten, repair or change any pipe clamp, pipe, hose, fuel cooler and flange screw of fuel cooler which have been lost, flexible or damaged.
  - 3) Don't bend or knock high-pressure pipe.
  - 4) Don't install any bending or damaged pipes or hoses.
- b) Check short circuit: it may lead to a fire disaster.
  - 1) Clean and tighten all the electric connection.
  - 2) Before every shift or after 8-10 hours' operation, check if the cables and electric wires have been loose, distorted, hardened or broken.
  - 3) Before every shift or after 8-10 hours' operation, checks if the terminal covers have been lost or damaged.
  - 4) If the cables and electric wires have been loose or distorted, don't operate the machine.
- c) Remove flammable objects: a fire can be caused by some flammable things such as splashed fuel, hydraulic oil, anti-freeze fluid, washing fluid, garbage, lubricant, oddment, deposited cinder and etc. check and clean the machine everyday, remove splashed or deposited flammable things timely to avoid a fire.
- d) Check key switch: when catching a fire, the engine failing to stop will aggravate the fire, which is a



Fig.1-94

disadvantage to putting out the fire. So before operating the machine everyday, always check the function of key switch:

- 1) Start the engine and run it at low idling speed.
- 2) Turn the key switch to OFF and confirm if the engine has stopped.
- 3) If there is something abnormal, make sure to repair the machine before operating it.
- e) Check the emergency cutoff switch of engine: when catching a fire, if the pressured air in hydraulic oil tank fails to be released, it will aggregate the fire and cause a trouble. So once every 250 hours, always check the function of emergency cutoff switch of engine.
  - 1) Start the engine and run it at low idling speed.
  - 2) Press down emergency cutoff switch of engine.
  - 3) Confirm the engine has stopped and the pressured air in hydraulic oil tank has been released(you can hear the sound of deflation).
  - 4) If there is something abnormal, make sure to repair the machine before operating it.
- f) Check insulation cover: a fire will be caused by the damage or loss of it, which if existing, should be repaired or renewed before operating the machine.

● **Withdraw when catching a fire**

- a) If catching a fire, leave from the machine according to the following method:



Fig.1-95

- 1) If time is permitted, turn the key switch to OFF and stop the engine.
- 2) If time is permitted, use fire extinguisher.
- 3) Leave from the machine.
- b) At the emergency, if the cab door and front window can't be opened, smash front or rear window glass with emergency hammer and then withdraw from the cab.

● **Beware of exhaustion**

Beware of exhaustion and suffocation. The exhaustion may lead to disease or death.

If you must work in the building, fully air ventilation should be guaranteed. The smoke can be discharged by lengthened exhaust pipe or opening door or window to introduce enough external air into working area.



Fig.1-96

● **Notices for welding and polishing**

- a) Before welding, plug of controller should be cut off.
- b) The welding will produce gas and flame. So :
  - 1) The welding must be carried out in fully ventilated and prepared place. Before welding, place the flammable things into safe area.
  - 2) Rather than unqualified, only those qualified through examination can do the welding.
- c) Polishing machine will give out sparks, so before the polish, put the flammable things into safe area.
- d) After the welding and polishing, check again if there is smoke around the welding area.



Fig.1-97

- **Avoid heating near the high-pressure hydraulic pipe**

Flammable sprayer will be produced by heat near the high-pressure hydraulic pipe, leading to a severe burning injury for you and the surrounding people.



Fig.1-98

- a) Don't weld or use welding torch near high-pressure hydraulic pipe or other flammable material.
- b) When the heat is accumulated to certain degree, high-pressure hydraulic pipe will be cut off. When doing the work like welding, the fireproofing cover must be installed to protect the hoses and other material.

- **Avoid heating pipes with flammable fluid inside**

- a) Don't weld or gas-cutting any pipes or hoses with flammable fluid inside.
- b) Before welding or gas cutting any pipes, remove flammable fluid completely with non-flammable solvent.

- **Remove the paint before welding or heating**

Because heated by welding or using welding torch, the paint will produce poisonous gas, which will cause a vomit if being taken in.

- a) Prevent the happening of latent poisonous gas and dust.
  - b) Carry out removing-paint work outdoors or in drafty place, dispose the paint and solvent correctly.
  - c) Remove the paint before the welding or heating.
- 1) If the sand paper or grinding wheel is to get rid of paint, pay attention not to suck in dust by wearing qualified respirator.
  - 2) If using the solvent or removing-paint agent, you should get rid of removing-paint agent with soap and water before welding. Clean the solvent, removing-paint agent container or other flammable object in working area. Before welding or heating, you should use at least 15 min. to disperse the volatile gas.

- **Avoid the explosion of battery**

- a) The gas in battery will explode.
  - 1) Prevent spark or burned match from getting close to the top of battery.
  - 2) Don't check the electricity of battery by placing one metallic object cross the terminal.
  - 3) Don't charge frozen battery, or there will be explosion. Warming up battery to 16°C.
  - 4) The loose of terminal may produce a spark, so all the connector should be tightened.
- b) Electrolyte of battery is poisonous, if the battery explodes, the electrolyte will enter into eyes, causing the blindness.



Fig.1-99

### Other operating procedures

#### ● Lift or move objects



#### Attention:

- 1) When using the machine to lift or move objects, you must abide by all the local regulations. Since the steel cable, strap or rope may be broken and lead to a severe casualty, so don't use damaged chain, broken steel cable or strap or rope to lift heavy thing. Move the object slowly and carefully. Sudden movement of load even above the person's head is not allowed. Don't let anyone get close to the load.
- 2) Ensure all the people are away from the load lifted or tied with steel cable and placed on ground, until the load has been supported by supporting block or placed on ground stably.
- 3) Position the upper machine body perfectly and keep the treading motor at the rear. Don't connect sling/chain with bucket teeth, which may come off and result in the falling of lifted object.
- 4) Don't let the sling entwine your hand and body.
- 5) When wind speed is high, don't use sling to lift or raise originally rated weight. When the exterior area of the cargo is relatively big, watch out any kinds of gust.
  - a) Bind the sling or chain tightly on the load supposed to be lifted. When binding the sling or chain, make sure to wear gloves.
  - b) Turn the bucket and withdraw the bucket lever, connect the sling or chain with bucket ring. Before starting, hand signs must be coordinated with the signaler.
  - c) Know very well the position of all the working staff in working site.
  - d) Connect hand-pulling rope with the load and ensure the puller is far away from the load.
  - e) Before the lift, measure the load weight and lift up.
    - 1) Lift the load to the height of 50mm away from the ground or lift it only to demanded height.
    - 2) Let the load go around nonstop to one side.
    - 3) Keep the load close to the ground and take it away from the machine.
  - f) If there is any unstable phenomenon, lower the load immediate down to the ground.



Fig.1-100

#### ● The operation of hammer-style knapper

As the picture, if there is hammer-style knapper in the machine, operate it with operating pedal front and right to the seat.



**Attention:** when not using the hammer-style knapper, you must lock operating pedal with pedal lock.

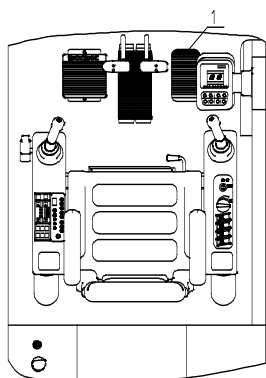

Fig.1-101  
1 — operating pedal

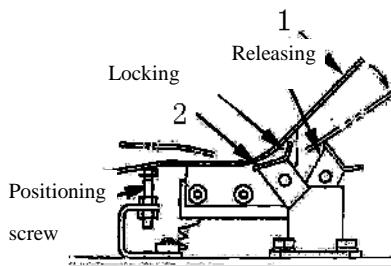

Fig.1-102  
1 — operating pedal  
2 — pedal lock

Choose knapping hammer mode (mode B) through working mode switch, the indicator of mode B will shine.

- a) Move the pedal lock and release the operating pedal.
- b) Step down the operating pedal and operate hammer-style knapper.
- c) Move your foot away from the operating pedal and stop the hammer-style knapper.
- d) When the operating pedal is not used, always lock the pedal with pedal lock.

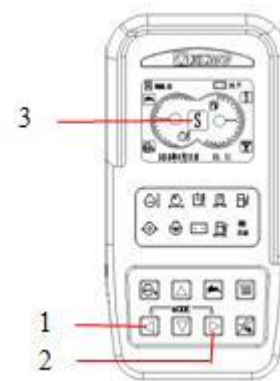

Fig.1-103  
1, 2 — working mode switch  
3 — mode B indicator

● Notices for operating hammer-style knapper



Attention:

- 1) Since the hammer-style knapper is heavier than bucket, so the stability of machine may be reduced.
- 2) When using hammer-style knapper, the machine is easier to incline and the flying or bouncing object may bounce into cab or other part of machine. Please abide by the following and other necessary notices to avoid the happening of accident and damage on machine.
  - a) Avoid using hammer-style knapper to bump into other object. Since the knapper is heavier than the bucket, so it will go down faster. Be careful, don't use the knapper to bump into other thing, or the knapper, front working



Fig.1-104

equipment and machine's upper structure may be shattered. Before operating the knapper, always move (lower down) the knapper slowly and put it on broken object.

- b) Don't use the knapper to rotate and move something, or the moving arm, bucket lever and knapper will be damaged.



Fig.1-105

- c) Prevent the damage on hydraulic cylinder or machine. When operating the knapper, don't retract or stretch the hydraulic cylinder lever fully.

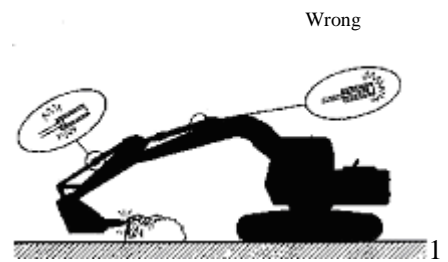

Fig.-106

- d) If there is abnormal jumpiness in hydraulic hose of knapper, please stop the operation at once. the pressure change inside the battery of knapper or damaged battery will lead to abnormal hose jumpiness and even cause the damage on knapper and (or) machine.

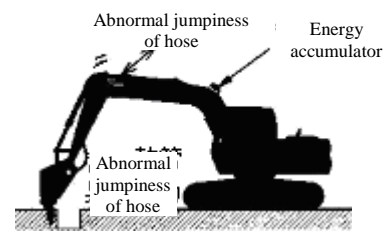

Fig.1-107

- e) Don't operate the knapper in water, which may make it rusted even damage the seal and components in hydraulic system.

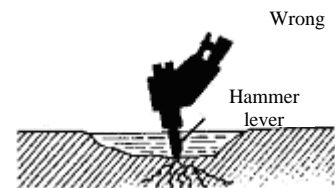

Fig.1-108

- f) Don't use knapper to lift heavy things, which may make the machine rave about and (or) lead to the damage of knapper.



Fig.1-109

- g) Don't rotate the upper machine structure to the side to operate the knapper. This action will make the machine unstable and even shorten the lifespan of lower machine parts.

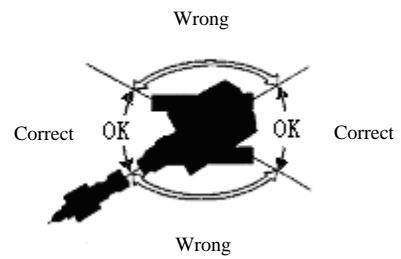

Fig.1-110

- h) Operate the hydraulic excavator carefully and prevent the knapper from bumping into moving arm.

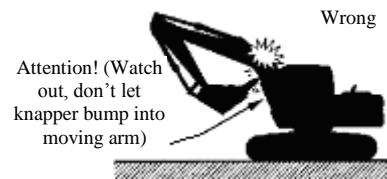

Fig.1-111

- i) Don't place the bucket lever on vertical position to operate the knapper, which may lead to the excessive vibration of hydraulic cylinder of bucket lever and even the oil leakage.



Fig.1-112

- j) Press down the knapper and place the hammer head(axial center)vertically on object and push it in.

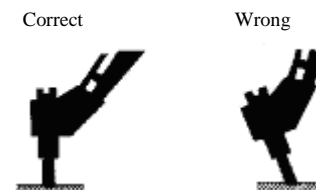

Fig.1-113

- k) Don't operate the knapper continuously for over 1 min., which may cause the excessive abrasion of hammer's head. If the object can't be shattered in 1 min., place the hammer's head to other positions, every change of which should not exceed 1 min.



Fig.1-114

- 1) It is possible to damage the front working equipment by relying on pressing down the knapper to prop up the lower machine body. Though it is permitted to prop up the front edge of lower body within 150mm, but normally this method is not necessary. You mustn't prop up the front edge of lower body for over 150mm only relying on pressing down the knapper.

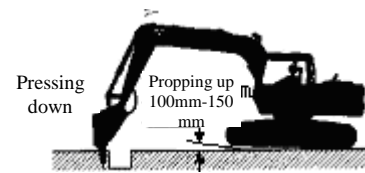





Fig.1-115



## Lubrication, maintenance and repair

### General principle

-  **Warning:** Only those trained and qualified can repair and maintain this machine.
  -  **Attention:** Before any maintenance, read carefully the related content in this book.
  -  **Attention:** If diesel engine is running indoors, ensure good ventilation condition.
  -  **Attention:** For the details of diesel engine, see **OPERATING MANUAL OF DIESEL ENGINE**, which is included in the documents along with the excavator.
- While carrying out maintenance or repair for this machine, the related record should be made and saved.
  - For the excavator, it is important to maintain and ensure its normal function. So the machine should be kept clean so that any failure such as leakage, looseness of screw or connection will be spotted.
  - Pay attention to environmental protection! Don't let oil and other things harmful to environment pollute our environment.
  - The content of this chapter includes items related to regular check, maintenance and repair. The operator of excavator should carry out according to the regulation.

**Lubrication of equipment**

**Attention: High-quality lubricant should be added according to appointed quantity. Excessive lubricant or grease may lead to overheating and even speed up the abrasion.**

**The kinds of lubricant**

List 2-1 List of lubricant varieties used for this machine

Lubricant varieties	Brand/name	Used for	Capacity(L)	Remark
Grease	2# highly pressured lithium-based grease	Pin shaft of working equipments	0.3	-20~40°C
		Swing bearing	2	
		Swing reducer	1	
		Rotation equipment oil-bath	12	
		Tension equipment	2	
Engine oil	CF 15W/40 oil	Diesel engine	25	-15~40°C
	CF 10W/30 oil	Diesel engine	25	-30~30°C
Lubricant	GL-4 SAE140 gear oil	Swing reducer	6.2	-20~40°C
	GL-4 SAE90 gear oil	Travel reducer	2×6.8	

**⚠ Attention: If the excavator works in specially high or cold condition, special lubricant should be used. You are suggested to contact with excavator dealer appointed by Xugong.**

**⚠ Attention: If the above requirements can't be satisfied, please contact with Xugong excavator agent or its after-market department.**

- Lubrication points

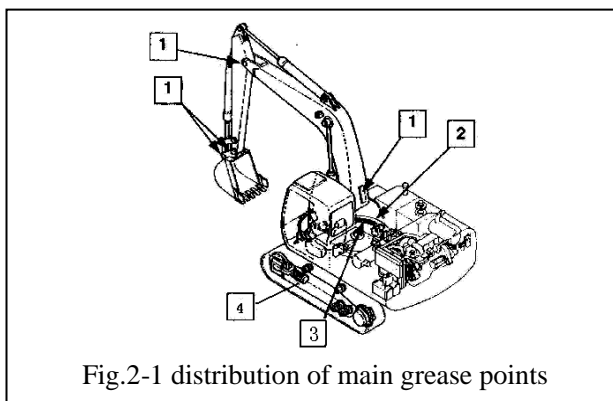

Fig.2-1 distribution of main grease points

Serial number	Position		Quantity
1	Connection points of working equipments	Bucket, bucket lever and pin of connection rod	9
		Others	11
2	Swing reducer		1
3	Swing bearing		2
	Rotation device oil-bath		1
4	Tension device		2

● Connection points of working equipments

a) Bucket, bucket lever and pin of connection rod

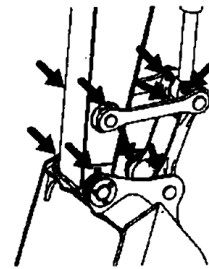

Fig.2-2

b) Pin at the root of moving arm

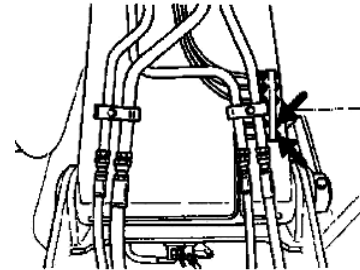

Fig.2-3

c) Connection pin between moving arm and bucket lever, hydraulic cylinder piston and bottom pins of bucket lever

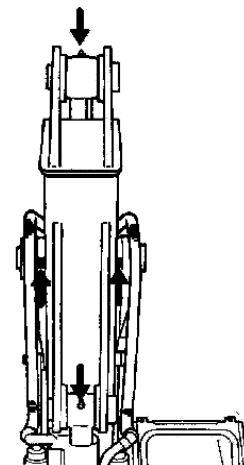

Fig.2-4

- d) Bottom of moving-arm hydraulic cylinder

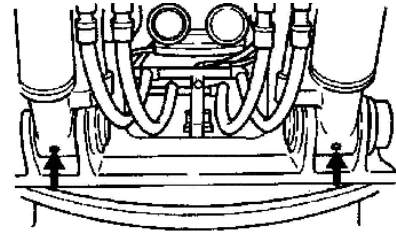

Fig.2-5

- e) Pin of moving-arm hydraulic cylinder and bottom pin of bucket-lever hydraulic cylinder

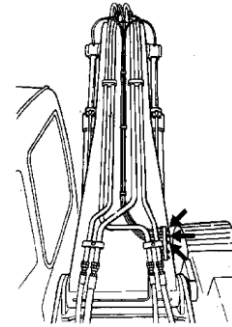

Fig.2-6

- Rotary support area

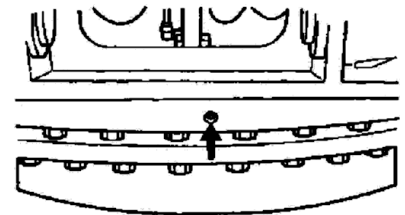

Fig.2-7

2 lubrication points for rotary support

- Rotation device oil-bath

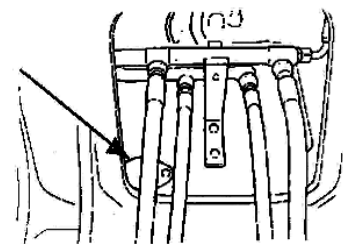

Fig.2-8

- Engine

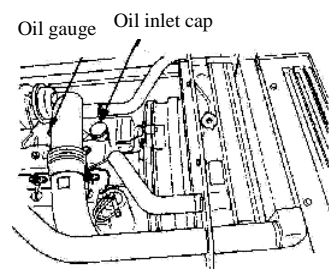

Fig.2-9

● **Travel reducer**

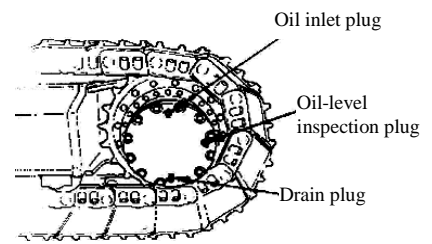

Fig.2-10

——2 lubrication points for treading gearbox

● **Rotary speed reducer**

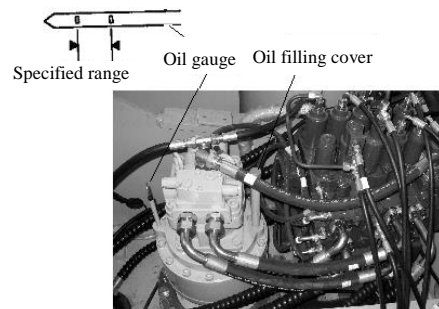

Fig.2-11

### Lubrication Period

● Schematic of lubrication and maintenance



图 2-12



● Table of lubrication periods:

Table 2-3 Lubrication Periods

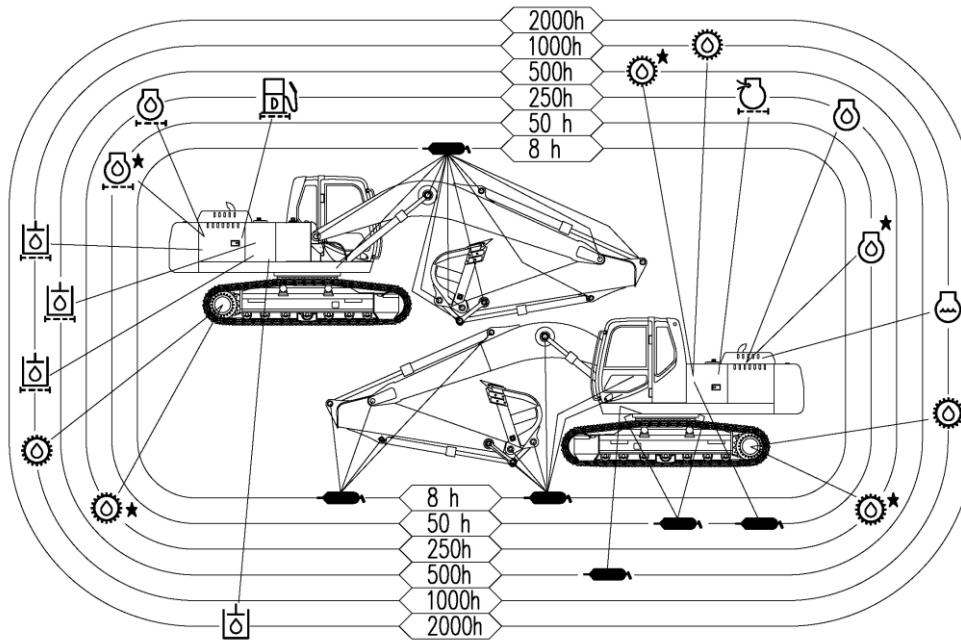
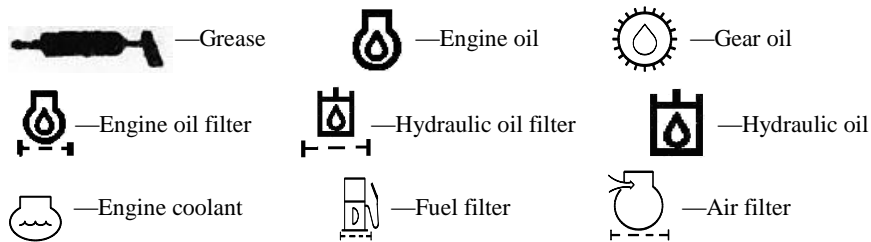
Item	S/N	Maintenance point		Qty	Interval (hour)								
					8	50	100	250	500	1000	1500	2000	
Grease	1	Work device	Bucket and link pin	9	√								
			Others	1	√								
	2	Rotary bearing	2		√								
	3	Rotation reducer	1					√					
Engine oil	1	Check of engine oil level		1	√								
	2	Replacement of engine oil				★		√					
	3	Replacement of engine oil filter		1		★		√					
Gear oil	1	Traction reducer	Check of oil level	2				√					
			Replacement	2				★		√			
	2	Rotary reducer	Check of oil level	1				√					
			Replacement	1					★	√			



Note: ★ Maintenance shall be required only for the first check.

### **Safety points for attention and precautionary measures**

- a) Summarize the working hours correctly to determine the lubrication time.
- b) Stop in case of filling the grease, and don't apply any lubrication work if not parked as per the requirements of this manual.
- c) Adopt the fire-prevention measures during the lubrication.
- d) Prevent hot oil and harmful substances from harming the operators.
- e) Avoid mixing the lubricating oils of different brands.
- f) Clean the lubricated parts and vent hole, etc before filling; keep the tightness of seal ring after filling.
- g) Clean or replace the filter at regular intervals, make a mark after draining the engine oil off, and don't start the filter without oil.
- h) Remove the spilled lubricant.

## Maintenance and repair

### Safety rules

#### ● Safety maintenance

a) In order to avoid any accident:

- 1) Learn of the maintenance regulations before the work.
- 2) Keep the work area clean and dry.
- 3) Don't spray water or steam in the cab.
- 4) Don't lubricate or maintain the machine with oil during the movement.
- 5) Prevent the hand, foot and clothes from contacting the rotating part.



Fig.2-13

b) Before maintaining the machine:

- 1) Park the machine on the level ground.
- 2) Fall the bucket to the ground.
- 3) Run the engine for 5 minutes at low speed and empty load.
- 4) Turn the key switch to OFF (off), and stop the engine.
- 5) Move the control lever several times to release the pressure in hydraulic system.
- 6) Remove the key from the key switch.
- 7) Hang up the nameplate "No Operation" on the control lever.
- 8) Pull the safety locking rod to LOCK (lock).
- 9) Cool the engine.

c) If the maintenance must be applied during the running of engine, a qualified driver must exist in the cab.

d) If the machine must be lifted during the maintenance, maintain the angle between the movable arm and bucket arm within 90° to 110°, support any lifted part of machine firmly, and don't work under the machine lifted by the movable arm.



Fig.2-14

e) Check the parts at regular intervals, and repair or replace them as per the demands.

f) Keep all the parts in good working state, and install them correctly.

g) Replace the worn or damaged parts in time, and remove any accumulated grease, oil or scrap.

h) Adopt inflammable cleaning oil, and prohibit to use the fuel or gasoline or other easily flammable oil to clean the part or surface.



Fig.2-15

i) Disconnect the grounding cable (-) of battery before regulating the electric system or welding on the machine.

j) Apply the sufficient illumination to the working places. In case of working under or inside the machine, use the working lamps with shields always, otherwise the breakage of bulb may ignite the spilled fuel, engine oil, anti-freezing fluid or washing fluid, etc.

#### ● Protection against separation of fragments

If the fragments are flied into the eye or bounced to any other part of body, they will cause the severe injuries to body.



Fig.2-16



- a) Use the safety goggles or safety glasses to avoid the injuries of splashed metal pieces or fragments.
- b) In case of hitting the object, prevent others from entering into the working place.

- **During the maintenance of machine, warn the others that any unexpected machine movement will cause the severe injuries, and hang up the nameplate “No Operation” on the control lever before maintaining the machine.**

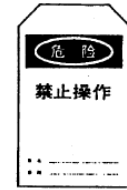

Fig.2-17

- **Correct supporting of machine**

Don't maintain and repair the machine before supporting the machine.

- a) Fall the front-end working device always to the ground before maintaining and repairing the machine.
- b) If the machine or front-end working device must be lifted for maintenance and repair, support the machine or front-end working device. Don't use the slag bricks, cord tires or racks to support the machine, because they may be fallen-in under the continuous load. Don't work under the machine supported with single jack.

- **Far from the rotating parts**

- a) The entrapment of rotating part may cause the severe injuries.
- b) In case of working beside the rotating part, don't make the hand, foot, clothes, jewellery or hair entrapped by the rotating part.



Fig.2-18

- **Avoiding the fly out of part**

- a) The grease in track-tension device is under a high pressure. In case of not obeying the following matters, severe injury, blindness or death may be caused:
  - 1) Don't remove the grease coupler or valve body.
  - 2) The body and face must be far away from valve body because it may fly out.
- b) The traction reducer has a certain pressure:
  - 1) Due to the possible flyout of part, the body and face must be away from the air bleed bolt to avoid any injury.
  - 2) The gear oil is hot, which may lead to scald injury. After cooling the gear oil, loosen the air bleed plug gradually to release the pressure.



Fig. 2-19

- **Safety storage of fittings**

The stored fittings such as bucket, hydraulic hammer and grafter may fall, resulting in severe injuries. Store the fittings and apparatus safely to avoid falling, so the children and other personnel should be far away from the storage area.

- **Pay attention to high-temperature fluid.**

- a) Avoid the heat injury caused by the sprayed high-temperature fluid. After the operation, the cooling water of engine is hot and has a certain pressure; there is hot water or steam in engine or radiator. If the skin contacts the spilled hot water or steam, the severe skin burns will be caused.
  - 1) Avoid the burning of hot water that may be sprayed out. Don't open the cover of radiator before cooling the engine. In case of opening the cover, turn the cover to bottom slowly, and remove the cover after releasing the pressure fully.



Fig. 2-21

- 2) Pressure exists in the hydraulic oil tank. Ensure the pressure is released before removing the cover.
- b) High-temperature fluid and surface. During the operation, engine oil, gear oil and hydraulic oil may become hot; engine, hose, pipe and other parts will also become
- c) After cooling the oil and parts, start to check or maintain them.



Fig. 2-22

● **Periodic replacement of rubber hose**

- a) Due to ageing, fatigue and wear, the rubber hose containing flammable fluid may be broken under the pressure. It's difficult to judge the poorness of rubber hose due to its ageing and wear, and replace the rubber hose at regular intervals.
- b) Irregular replacement of rubber hose may cause the fire, the injection of fluid into skin or the knock of front-end working device to persons around it will cause severe heat injury, dermal gangrene, other injuries or death.

● **Pay attention to high-pressure fluid**

If the fuel, hydraulic oil or other fluids injected under high pressure can penetrate the skin or rip into the eyes, it will cause severe injury, blindness or death.



Fig. 2-23



Fig.2-24

- a) Release the pressure before removing the hydraulic or other pipes to avoid this risk.
- b) Tighten all the connections before pressurizing them.
- c) Check the leaks with a paper board, and protect your hands and body to avoid the contacts with high-pressure fluid. Wear the face mask or safety goggles to protect your eyes.
- d) In case of any accident, let the doctor who's familiar with this type of wound cure immediately.



Fig. 2-25

Any fluid injected into skin must be removed through surgery within several hours, otherwise the dermal gangrene will be caused.

● **Treatment of accumulator**

The pilot control system is equipped with an accumulator filled with high-pressure nitrogen, so the pressure of system must be relieved during the maintenance of pilot control system. It's very dangerous in case of incorrect operation.

- a) Don't drill on the accumulator, or don't make it contact the flame, fire or heat source.
- b) Don't weld the accumulator, or don't attach any article on it.
- c) In case of removing, maintaining or treating the accumulator, the filled gas must be discharged. Contact with our company or supplier.

- d) In case of treating the accumulator, wear the safety goggles and protective gloves. The high-pressure hydraulic oil will stab the skin or cause the injury.

- **Safety maintaining air-conditioning system**

The splash of refrigerant on skin will cause the frost injury.

- a) During the maintenance of air-conditioning system, use Freon correctly as per the instructions for Freon container.
- b) Adopt the recovery or recirculation system to prevent Freon from discharging into the into the atmosphere.
- c) Don't make Freon fluid contact the skin.



Fig.2-26

- **Correct treatment of discards**

Any improper treatment of discards will harm the environment and ecology, and the potential harmful discards include hydraulic oil, fuel, engine oil, coolant, filter and battery, etc.

- a) In case of discharging the fluid, use the leak proof container. Don't use the food or drink vessel, because it may cause the wrong drinking.
- b) Don't pour the waste liquid on the ground, into sewerage or any water source.
- c) The air-conditioning refrigerant is leaked into the air, which will damage the atmospheric layer of the earth. According to the government regulations, an air-conditioning service center with desired certificates may be required to recover and regenerate the air-conditioning refrigerant.
- d) Inquire the correct recovering or treatment methods of discards from local environmental protection or recovery center or your assigned dealer.

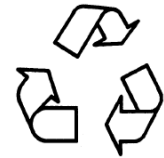

Fig.2-27

### Maintenance

● **Check and maintenance of hydraulic device**

⚠ **Note: during the operation, the parts of hydraulic system will become very hot, and cool the machine before starting the check or maintenance.**

- a) During the maintenance of hydraulic device, ensure that the machine shall be placed on the flat or hard ground.
- b) Fall the bucket to the ground, and turn the engine off correctly.
- c) Maintain the hydraulic device after cooling the machine part, hydraulic oil and lubricating oil fully, because the residual heat and pressure will exist in the hydraulic device soon after finishing the operation.
  - 1) Drain the air in the hydraulic oil tank to release its inner pressure.
  - 2) Cool the machine. Check and maintain the high-temperature or high-pressure parts, because they may cause the sudden flyout or spray of parts or hydraulic oil and the personal injury.
  - 3) In case of removing the plug, don't make your body and face against them, because any hydraulic part may still have a certain pressure even if the part has been cooled.
  - 4) Don't try to maintain or check the traction or rotary motor circuit on the slope, because they can have high pressures due to their own weights.
- d) During the connection to the hydraulic hose and pipe, pay special attention to the seal surfaces to ensure no dirt exists on them, and avoid the damages to them. Please remember the following points for attention:
  - 1) Clean the inner face of hose, pipe or oil tank with cleaning fluid, and dry them thoroughly before connecting them.
  - 2) Use non-destructive or defective O rings, and don't damage them during the assembling.
  - 3) During the connection of hose, don't make the high-pressure hose distorted, because the lifetime of twisted hose will be greatly reduced.
  - 4) Tighten the low-pressure hose clamp cautiously, and ensure they can't be screwed too tight.
- e) In case of filling the hydraulic oil, use the oil of the same brand always, and don't mix the oils of different brands. In case of wishing to use the oil listed in "Brands and Names of Recommended Hydraulic Oils", ensure that all the hydraulic oil in the system is fully replaced.
- f) Don't run the engine without oil in hydraulic oil tank.

● **Check of hydraulic oil level**

**Important: don't run the engine without oil in hydraulic oil tank.**

- a) Check the level of hydraulic oil every day.
- b) Park the machine on the flat ground.
- c) Retract the state positioner fully with a bucket rod hydraulic cylinder, and stretch it out fully with a bucket hydraulic cylinder.
- d) Stop the engine as per the shutdown steps of engine (P20).

**Important: if the shutdown steps of engine are incorrect, the turbo supercharger may be damaged.**

- e) Pull the safety locking rod to LOCK (Lock).



Fig.2-28

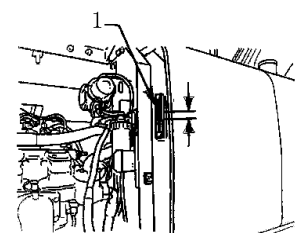

Fig.2-29

1 — liquid-level meter

- f) Open the access door at the hydraulic pump, check the liquid-level meter on hydraulic oil tank.  
The oil level must be between the marks on the level meter, otherwise add in the hydraulic oil.



**Note: the hydraulic oil tank has a certain pressure. Release the pressure of oil tank and remove the cover carefully before removing the oil tank cover.**

- g) Add in the hydraulic oil, and check the level meter again.
- h) Attach the cover, and ensure the components of filter and hanger rod are correctly positioned.

● **Drain the dirt reserve tank of hydraulic oil tank**

**Important: don't run the engine without oil in hydraulic oil tank.**

- a) Drain the dirt reserve tank of hydraulic oil tank once every 250 hours.
- b) For the convenience of access, rotate the upper car by 90°, and park the machine on the flat ground.
- c) Stop the engine as per the shutdown steps of engine (P20).

**Important: if the shutdown steps of engine are incorrect, the turbo supercharger may be damaged.**

- d) Pull the safety locking rod to LOCK (lock).



**Note: the hydraulic oil tank has a certain pressure. Release the pressure firstly, don't loosen the drain plug before cooling the oil, because the oil may be hot and cause the severe scald injury.**

- e) After cooling the oil, loosen the drain plug in the bottom of hydraulic oil tank, and drain the water and deposits.

Don't remove the plug fully, and you'd better loosen it enough to drain the water and deposits.

- f) After draining the water and deposits, tighten the drain plug again.

● **Replacement of hydraulic oil or cleaning of oil suction filter**



**Note: the hydraulic oil may be hot, and the oil must be cooled before starting the work.**

- a) Replace the hydraulic oil or clean the oil suction filter every 2000 hours.
- b) For the convenience of access, rotate the upper car by 90°, and park the machine on the flat ground.
- c) Retract the state positioner fully with a bucket rod hydraulic cylinder, and stretch it out fully with a bucket hydraulic cylinder.
- d) Stop the engine as per the shutdown steps of engine (P20).

**Important: if the shutdown steps of engine are incorrect, the turbo super charger may be damaged.**

- e) Pull the safety locking rod to LOCK (lock).
- f) Clean the top of hydraulic oil tank, and prevent the dirt from intruding into the hydraulic system.



**Note: the hydraulic oil tank has a certain pressure. Release the pressure, and then remove the oil tank cover.**

- g) Remove the oil tank cover.
- h) Draw off the hydraulic oil with a pump. The capacity of hydraulic oil in

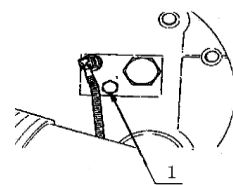

Fig.2-30  
1—Dirt drain plug

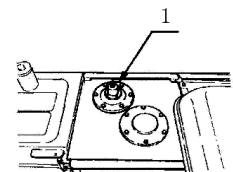

Fig.2-31  
1—Oil tank cover

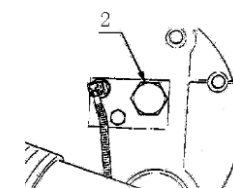

Fig.2-32  
2—Oil drain plug

the tank:

XE210C:220L.

XE230, XE260C: 240L.

- i) Remove the drain plug to make the hydraulic oil discharged.
- j) Take out the components of oil suction filter and hanger rod.
- k) Clean inner sides of filter and oil tank. In case of replacing the filter, attach a new filter to the hanger rod as shown in right figure.
- l) Attach the components of filter and hanger rod, and ensure the filter is correctly fixed on the outlet.
- m) Replace the oil filter of hydraulic oil tank (refer to “List of Maintenance Periods”).
- n) Clean, attach and tighten the drain plug.
- o) Fill the hydraulic oil up to its level between the marks of level meter.
- p) Attach the oil tank cover, and ensure the components of filter and hanger rod are in correct positions.

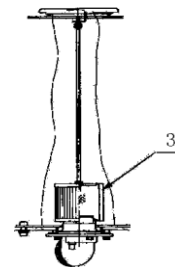

Fig.2-33

3—Components of oil suction filter and hanger rod

**Important: in case of starting the engine without oil in hydraulic pump, it will damage the hydraulic pump.**

- q) Remove the air bleed plug from the top of hydraulic pump.
- r) Fill up the hydraulic pump with hydraulic oil through the hole of air bleed plug.
- s) Attach the air bleed plug.
- t) Start the engine and run it at low speed and empty load. Hang “No Operation” nameplate to the safety locking rod, and ensure the safety locking rod in LOCK (lock) position.
- u) Loosen the air bleed plug slowly to discharge the accumulated air. When the flow of air stops and the oil is discharged out of the plug hole, tighten the plug.
- v) Run the engine at low speed and empty load, and actuate the control lever slowly or stably for 15 minutes to discharge the air out of the hydraulic system.
- w) Retract the state positioner fully with a bucket rod hydraulic cylinder, and stretch it out fully with a bucket hydraulic cylinder.
- x) Stop the engine as per the shutdown steps of engine (P20).
- y) Pull the safety locking rod to LOCK (lock).
- z) Check the level meter of hydraulic oil tank. If necessary, open the oil tank cover to add in the oil.

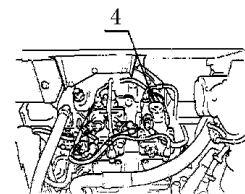

Fig.2-34

4—Air bleed plug

● **Drain the dirt reserve tank of fuel tank.**

- a) Drain the dirt reserve tank of fuel tank every day.
- b) For the convenience of access, rotate the upper car by 90°, and park the machine on flat ground.
- c) Stop the engine as per the shutdown steps of engine (P19).

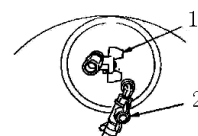

Fig.2-35

1—Drain ball valve

2—Fuel ball valve

**Important: if the shutdown steps of engine are incorrect, the turbo**

supercharger may be damaged.

- d) Pull the safety locking rod to LOCK (lock).
- e) Open the drain ball valve in the bottom of fuel tank for several seconds to discharge the water and deposits, and then close the ball valve.

● **Check of water separator**

Check the water separator before the operation every day.

The water separator may mix the water in fuel. The water separator contains a floating body that will float up during the accumulation of water to ensure the water separator starts to drain when the floating body reaches the mark of “ Drain water ”on outer side of oil-water separator.

**Important: if the fuel contains excessive water, shorten the check interval of water separator.**

Drain steps

- a) The water separator is located on fuel prefilter near to the hydraulic pump, open the right side shed door, and fix the door with a fixing bar.
- b) Close the fuel ball valve (Fig.2-35) in the bottom of fuel tank to stop the supply of fuel.
- c) Loosen the air bleed plug on top of fuel prefilter, and anticlockwise loosen the drain plug in the bottom of water separator to drain the water accumulated in water separator.
- d) After draining the water, tighten the air bleed plug and drain plug. Turn the fuel ball valve to its original position.
- e) Start the engine, and check whether there is leakage or not of the plug and air bleed plug.



**Note:** ensure that the air is bled out of the hydraulic system after drawing the water.

● **Bleed the water out of hydraulic system.**

**Important: the air in fuel system may cause the starting difficulty or abnormal starting of engine. After draining the water and deposits in oil-water separator, replacing the fuel filter or drying the fuel tank, ensure the air must be bled out of hydraulic system.**

- a) Determine that the drain plug and air drain plug of oil-water separator are tightened. If the air bleed plug is not tightened, the air in hydraulic system won't be exhausted.
- b) Ensure the fuel ball valve in the bottom of fuel tank has been opened.
- c) Loosen the air bleed plug on the fuel filter.
- d) Loosen the hand wheel on fuel supply pump, and move the plunger up and down until no air bubbles are seen from the air bleed plug.
- e) Tighten the air bleed plug, and continue to move the plunger of fuel supply pump up and down until the load becomes heavier.
- f) Push down the hand wheel of fuel supply pump, and tighten it.
- g) Start the engine, and run it at low speed and empty load.

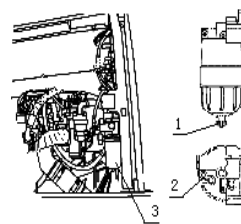

Fig. 2-36

- 1—Air bleed plug
- 2—plug
- 3—Fuel prefilter

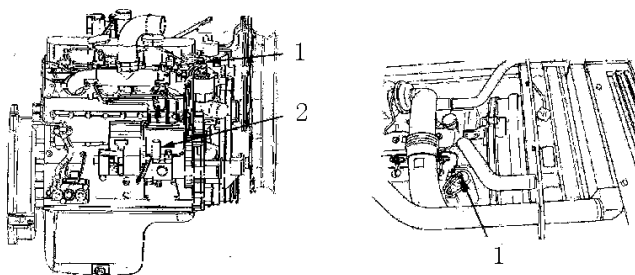

Fig. 2-37

- 1—Air bleed plug
- 2—Fuel supply pump

- h) Hang “No Operation” nameplate to the control lever.
- i) Pull the safety locking rod to LOCK (lock).
- j) Check the hydraulic system for leaks.

● **Replacement of fuel filter**

- a) Replace the fuel filter every 250 hours.
- b) For the sake of safety and environmental protection, use the proper containers always for draining the fuel oil. Don’t pour the fuel on the ground, into the ditch, river, pond or lake, and treat the waste fuel properly.
- c) Remove the cartridge filter with a filter spanner.
- d) Apply a thin layer of clean fuel to the gasket of new cartridge filter.
- e) Tighten the cartridge filter by hands until the gasket contacts the seal face.
- f) Turn the cartridge filter by ca. 2/3 circle with a filter spanner to tighten it, but it shall not be screwed too tight.
- g) After replacing the cartridge filter, bleed the air out of hydraulic system.

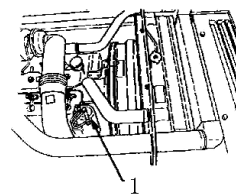

Fig.2-38

1— Cartridge filter

The above methods are for the replacement of second-class fuel filter on the engine side, and those of first-class fuel filter on the pump chamber side are the same as the above methods.

● **Cleaning of outer element of air filter**

Clean the outer element of air filter every 250 hours or when the warning lamp of air filter element brightens, clean the outer element of air filter.

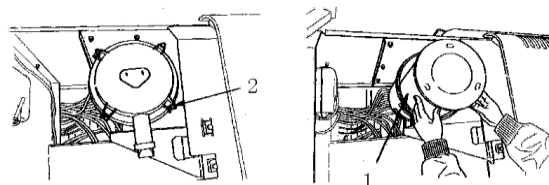

Fig.2-39

1—Outer filter element    2—Fixing clip

● **Replacement of inner and outer elements of air filter**

After six-time cleanings or one year, replace inner and outer elements of air filter.

- a) Park the machine on flat ground.
- b) Stop the engine as per the shutdown steps of engine (P20).

**Important: if the shutdown steps of engine are incorrect, the turbo supercharger may be damaged.**

- c) Pull the safety locking rod to LOCK (lock).
- d) Loosen the fixing clip, and remove the end cover.
- e) Remove the outer filter element.
- f) Flap outer filter element lightly by hands, and don’t on any hard object.
- g) In case of cleaning outer filter element with compressed air, blow outward from inner side of outer filter element.



**Note: adopt low-pressure air (less than 0.2MPa) to clean, have the personnel in the adjacent area away, protect against the splashed fragments, and wear the personal protection equipment, including safety goggles**

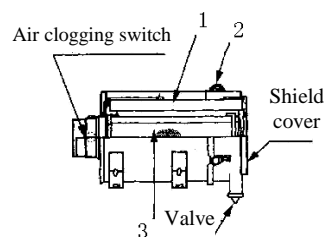

Fig.2-40

1—Outer filter element  
2—Fixing clip  
3—Inner filter element



or safety glasses.

- h) Attach the outer filter element.
- i) Attach the end cover, and tighten the fixing clip.
- j) Start the engine, and run it at low speed and empty load.

Check the warning indicator of air filter element on the monitor. If the indicator goes on, stop the engine immediately and replace the outer filter element.

- k) In case of replacing the element of air filter, replace inner and outer filter elements together. Remove the outer filter element; clean inner sides of filter before removing the inner filter element; remove the inner filter element; install the inner filter element, and then install the outer filter element.

● **Check of coolant level**

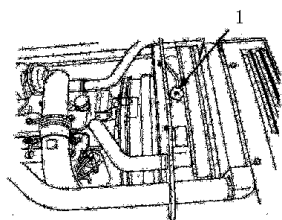

Fig.2-41  
1—Radiator cap

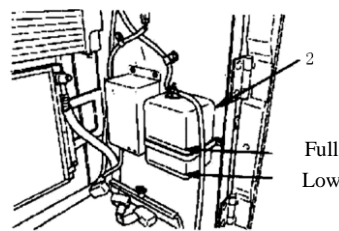

Fig.2-42  
2—Cooling water tank

**⚠ Note: unless the system has been cooled, don't loosen the radiator cap. Release the whole pressure before removing the cover, and then screw it off slowly.**

Check the level of coolant every day.

The level of coolant must be between the marks FULL and LOW on coolant tank. The water tank shall be located behind the radiator shed door. If the coolant level is below LOW mark, add the coolant into the water tank. If the water tank is empty, add the coolant into the water tank after adding the coolant into the radiator.

● **Cleaning of radiator inner side**

**⚠ Note: don't loosen the radiator cap before cooling the engine. Release the whole pressure before removing the cover, and then screw it off slowly.**

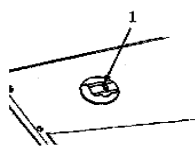

Fig. 2-43  
1—Radiator drain cock

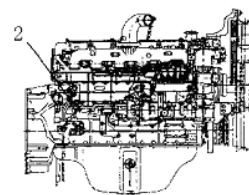

Fig. 2-44  
2—Engine drain cock

- a) During the replacement of coolant, clean the inner side of radiator.
- b) Remove the radiator cap, open the drain cocks of radiator and engine body to empty the coolant.
- c) Close the drain cock, add fresh water and radiator cleaner into the radiator, start the engine, and run it at the speed higher than low idle speed. When the pointer of cooling water thermometer enters into the green area, continue to run the engine for ca. over ten minutes.

- d) Close the engine, open the drain cock, and flush the cooling system with fresh water until the drained water becomes clean so as to remove the dirt and deposits.
- e) Close the drain cock, add the fresh water, and add the antirust agent and antifreeze agent into the radiator as per the specified mixing ratio. In order to prevent the air bubble from mixing into the system, add in the coolant slowly.
- f) Run the engine to bleed the air of cooling system fully.
- g) After adding in the coolant, make the engine running for several minutes. Check the level of coolant again, and add in the coolant again according to the demands.

● **Electric control system**

**Important: the installation of improper radio communicators and accessories will influence the electronic elements of machine and cause the unexpected movement of machine. The installation of improper electric devices may also cause the fault or accidental fire. During the installation of radio communicators or additional electric components or replacement of these components, be sure to consult with the assigned dealer. Don't attempt to disassemble or modify any electric or electronic component. If it's necessary to replace or modify these components, please contact with the assigned dealer.**

● **Battery**

 **Note: the gas of battery can cause the explosion approaching the battery.**

- a) This machine adopts the maintenance-free battery, so it's unnecessary to add in the water frequently.
- b) Check the capacity of battery frequently to increase lifetime.

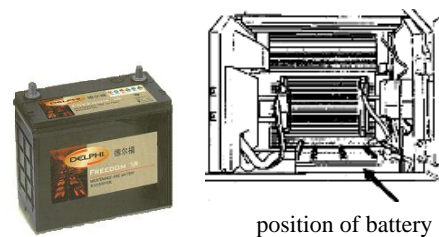

Fig.2-45 Position of battery

● **Check of battery**

- a) Check the capacity of battery at least once every month.
- b) Park the machine on flat ground.
- c) Stop the engine as per the shutdown steps of engine (P20).
- d) Check the capacity of battery. Observe the densimeter from the upper part of battery.



Fig.2-46

1—Level meter 2—Porthole

If the following circles are seen from round porthole:

Green circle—indicate the normality of battery

Black circle—indicate the low capacity of battery that needs to be charged

White circle—indicate the discarding of battery that needs to be replaced.

- e) Keep the terminal of battery clean always to avoid the discharge of battery. Check the terminals for loosening or rusting, and apply the grease or Vaseline to avoid the corrosion.

● **Replacement of battery**

There are two negative (-) grounded 12V batteries on the machine. If one battery of 24V system fails but the other is still good, replace the failed battery with the battery of the same type. For example, replace the failed and maintenance-free battery with new battery. The charging speeds of batteries in different forms may be different, which may make one of these batteries fail due to overload.

● **Replacement of fuse**

If the electric device doesn't work, check the fuse at first. The fuse box is located behind the seat, open the fuse box cover up, and the spare fuse is located under the cover.

**Important: avoid the damages to electric device due to overload, and install the fuse with correct amperage.**

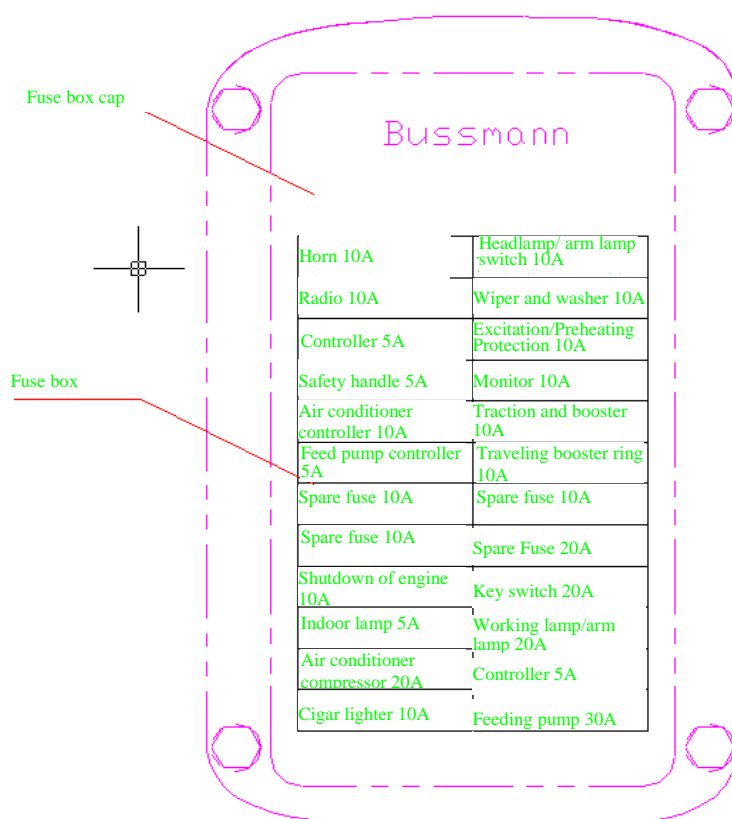

24 Schematic of fuse box layout

Schematic Code	Name	Rated Current	Schematic Code	Name	Rated Current
F4	Horn	10A	F5	Headlamp/ arm lamp switch	10A
F12	Radio	10A	F9	Wiper and washer	10A
F14	Controller	5A	F13	Excitation/Preheating Protection	10A
F16	Safety Handle	5A	F15	Monitor	10A
F19	Air-conditioner Controller	10A	F18	Traction and booster	10A
F23	Rotary Brake	5A	F20	Traction and booster ring	10A
F17	Pump Controller	5A		Spare Fuse	10A
	Spare Fuse	10A		Spare Fuse	20A
F1	Shutdown of engine	10A	F3	Key switch	20A
F7	Indoor lamp	5A	F6	Arm lamp and working lamp	20A
F8	Air-conditioner compressor	20A	F22	Controller 2	5A
F11	Cigar lighter	20A	F10	Pump	30A

● **Replace the bucket**

⚠️ **Note:** avoid the injury caused by the flyout of metal filling or fragments in case of hitting out or in the connecting pin, and wear the safety goggles or safety glasses and safety appliances applicable for operation.

- a) Park the machine on flat ground. Fall the bucket to ground, fix its plane on the ground, and ensure the pin shaft can't be rolled after removing the pin shaft.
- b) Side O-ring out as shown in Fig. 2-48.
- c) Remove bucket pin shafts A and B, separate the bucket rod bucket, clean pin shaft and pin hole, and apply enough lubricating oil to pin shaft and pin hole.
- d) Align the bucket rod and new bucket, and ensure the bucket can't roll.
- e) Attach the bucket pin shafts A and B.
- f) Attach the lock pin and retaining ring to pin shafts A and B.
- g) Adjust connecting clearance of bucket at pin shaft A (see "Adjust connecting clearance of bucket").
- h) Apply the grease to pin shafts A and B.
- i) Start the engine, and run it at low idle speed. Turn the bucket slowly in bc directions to check if the rotation of bucket is disturbed. Don't use any disturbed machine. If any disturbance, deal with it in time.

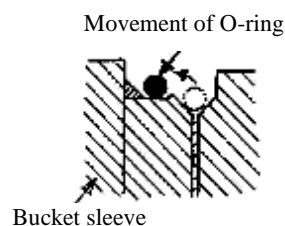

Fig.2-48

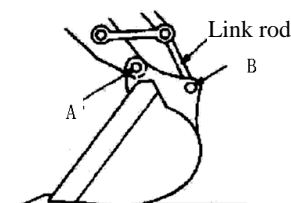

Fig.2-49

● **Adjustment of bucket joint gap**

There is a regulation system of bucket connection gap capable of eliminating the connection slashing. When the connection slashing is increased, remove or attach the tab as described below.

- a) Park the machine on flat ground, fall the bucket to ground with its plane down to avoid rolling the bucket.
- b) Run the engine at low idle speed, turn the bucket clockwise on the ground until left boss top of bucket contacts the bucket rod.
- c) Stop the engine. Pull the safety locking rod to LOCK (lock).

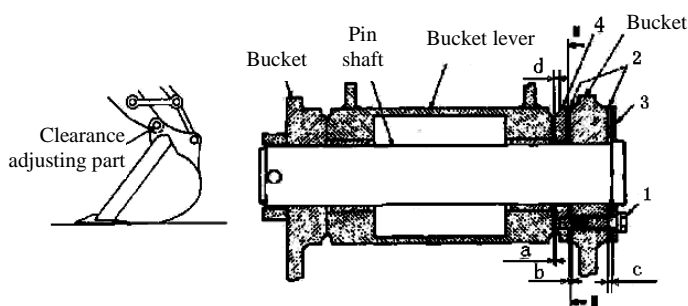

Fig.2-50

1-Bolt 2-Adjusting shim 3-Pressure plate 4-Cam

🔧 **Note:** in case of removing the tab, don't remove the bolt (Item 1 shown in Fig.2-51). The tab is half round, so it's easy to push them out with a screwdriver after loosening the bolt.

- d) Loosen the bolt slightly with a spanner. Push out all the tabs in the clearance c between the pressure plate and bucket.
- e) Push the bolt to one side of bucket rod, and eliminate the whole clearance a between bucket rod and cam. Push the cam onto the bucket rod to increase the clearance b, and measure the clearance b with a

feeler gauge, which shall not be adjusted below 0.5mm.

- f) Attach the adjusting shims as much as possible in the clearance b.



Note: be sure to the residual adjusting shims in the clearance c to avoid the damages to bucket rod tail end face or bolt.

- g) Attach the residual tabs in the clearance c, and tighten the bolt.



Note: the total number of tabs is 12 (6 pairs).

- h) If the measured value d is below 5mm, replace the cam.

● **Removal of traction control lever**

If necessary, remove the traction control lever.

- a) Fall the bucket to ground.
- b) Stop the engine as per its shutdown steps (P20).
- c) Pull the safety locking rod to LOCK (lock).
- d) Remove the bolts 1 and 2, and remove the traction control levers 3 and 4 from the control valve.

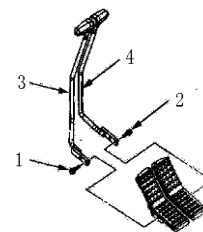

Fig.2-51

1, 2—Bolt

3, 4—Traction control lever

● **Check and replacement of safety belt**

Check the safety belt every day; replace the safety belt every 3 years.

Keep the safety belt always good, and replace it if necessary to ensure its good performance.

Check the safety belt; lock latch and connector thoroughly before the operation.

If the safety belt or its part is damaged or worn, replace it before the operation.

We suggest that the safety belt shall be replaced once every three years, regardless of its conditions.

● **Check of crawler sag**

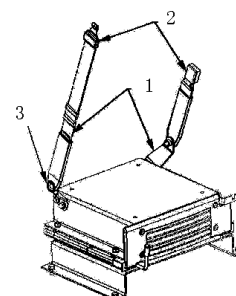

Fig.2-52

1—Safety belt 2—Lock latch

3—Connector

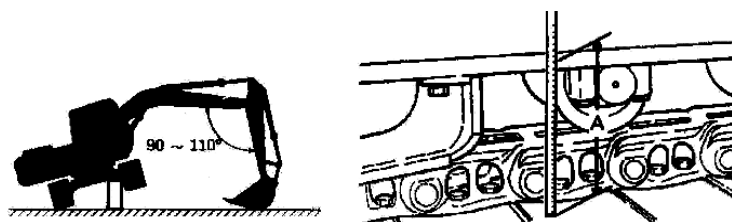

Fig.2-53

Check the crawler sag every day.

As shown in Fig.2-53, rotate the upper car by 90°, and then fall the bucket to lift the crawler away from the ground, keep the angle between the movable arm and bucket rod within 90° to 110°, place the arc part of bucket on the ground, place the cushion block under the frame of chassis to support the machine, rotate the crawler back by two circles, rotate it forward by two circles, and measure the distance A between frame bottom and track plate back from middle part of chassis frame.

Requirements of crawler sag:

XE210C, XE230, XE260C: A=300 to 335mm.



Note: check the slag of crawler after removing the soil on the track plate.

● **Adjust the sag of crawler.**

- a) Points for attention for adjusting the crawler sag
  - 1) If the crawler sag is not within the desired range, loosen or tighten the crawler as per the steps below.
  - 2) During the adjustment of crawler sag, fall the bucket to ground, and jack the crawler on one side. Apply the same methods to the crawler on the other side. Place the cushion block under the frame every time to support the machine.
  - 3) After adjusting the crawler sag on both sides, move the machine forward and backward several times.
  - 4) Check the sag of crawler again. If the crawler sag can't reach the specified value, continue to adjust it until it's satisfactory.

b) Loosen the crawler.



Note:

- 1) Don't loosen the valve body rapidly or Excessively, otherwise the grease in the tensioner will spray. Loosen the valve body carefully, and don't make the body and face against it.
- 2) Don't loosen the grease coupler. Important: if the crushed stones or soils are clipped between the driving wheel and crawler, remove them after loosening the crawler.

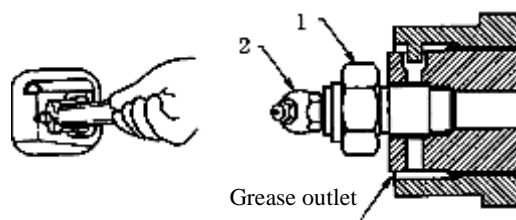

Fig.2-54

1—Valve body 2—Grease coupler

- 1) In case of loosening the crawler, rotate the valve body slowly anticlockwise with a deep socket wrench, and the grease will drain out of its outlet.
- 2) Rotate the valve body by 1 to 1.5 circles enough to loosen the crawler.
- 3) If the grease can't be smoothly drained, lift the crawler away from the ground, and rotate the crawler slowly.
- 4) After reaching the proper crawler sag, tighten the valve body clockwise.

c) Tighten the crawler.



Note: if the crawler is still too tight after tightening the valve body anticlockwise, or it is still loose after applying the grease into the grease coupler, this is abnormal. At this time, don't try to remove the crawler or track-tension device, because the high-pressure grease of track-tension device is dangerous. Therefore, overhaul it or contact with your assigned dealer.

If it's necessary to tighten the crawler, connect the grease gun to grease coupler, add in the grease until the crawler sag reaches the specified value.

● **Check of air conditioner**

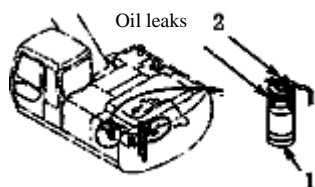

Fig.2-55

1—Liquid reservoir 2—Interface

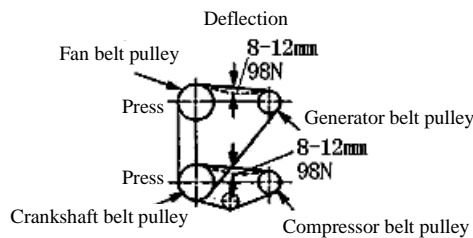

Fig.2-56

- a) Check the air conditioner every day.
- b) Check the cooling gas at the connections of pipe for leaks (as shown in above figure). If the oil leaks

are found near to the connections of pipes, the air leak may occur to these connections.

- c) Check of refrigerant amount: after running the engine at 1500r/min for 1 to 3 minutes, check the amount of refrigerant through a sight glass on the liquid reservoir.
- d) Check of condenser: if the blade of condenser is blocked by dirt or bugs, its cooling effects will be reduced. Therefore, keep them always clean.
- e) Check of compressor: after using the air conditioner 5 to 10 minutes, touch the pipes on high- and low-pressure sides. If they are normal, the pipe on high-pressure side shall be hot, while that on low-pressure side shall be cold.
- f) Check the mounting bolt for loosening: ensure the mounting bolt and other mounting or tightening bolts of compressor are well tightened.
- g) Check of belt and adjustment of tension: Check the compressor and fan belt for wears visually. According to the above figure, check and adjust the tension of belt. The pressure of fan and compressor belt: ca.98N, deflection: 7 to 10mm.

● **Check the tightening torques of bolt and nut.**

Check the tightening torques of bolt and nut every 250 hours.

After the first 50 hour breaking-in period of machine, check the tightness of bolt and nut, and then check it once every 250 hours. If loose, tighten the bolt up to the torque shown in Tightening of Bolt. In case of replacement, replace it with the same or higher-class bolt and nut. For the bolt and nut outside Tightening of Bolt, refer to “Tightening Torques”.

**Important: check or tighten the bolt and nut with a torque wrench.**

- a) Tightening Torques of Bolt

Table 2-4 Tightening of Bolt

S/N	Item	Bolt diameter mm	Qty	Sleeve size mm	Torque Nm	
1	Fixing bolt of engine vibration isolating rubber gasket (pump side)	18	2	27	410	
	Fixing nut of engine vibration isolating rubber gasket (fan side)	12	4	18	120	
2	Fixing bolt and nut of engine bearer	10	14	16	70	
3	Fixing bolt of hydraulic oil tank	18	4	27	300	
4	Fixing bolt of fuel tank	16	4	24	210	
5	Fixing bolt of hydraulic pump	20	4	30	600	
6	Fixing bolt of multi-way valve	12	3	18	120	
7	Fixing bolt of multi-way valve holder	16	4	24	210	
8	Fixing bolt of rotation gear	20	13	30	600	
9	Fixing nut of battery	10	2	16	50	
10	Fixing nut of cab	16	4	24	210	
11	Fixing bolt of rotary bearing (upper car)	XE210C	22	32	34	800
		XE230C/XE260C	22	36	34	800
	Fixing bolt of rotary bearing (lower car)	XE210C	20	36	30	600
		XE230C/XE260C	22	36	34	800
12	Fixing bolt of traction unit	16	60	24	300	
13	Fixing bolt of driving wheel	16	44	24	300	
14	Fixing bolt of bearing roller	16	16	24	300	
15	Fixing bolt of bearing wheel	XE210C	18	56~64	27	410
		XE230C	18	72	27	410
		XE260C	18	72	27	410
16	Fixing bolt of track plate	XE210C	18	368~376	27	410
		XE230C	18	376	27	410

		XE260C	18	408	27	400
17	Fixing bolt of rail clamp		16	8	24	210
18	Supporting bolt and nut of working device pin shaft		16	-	24	280
19	Counterweight mounting bolt	XE210C	36	4	55	3000
		XE230C/XE260C	36	4	55	3000
20	Low-pressure pipe adapter and T-shape bolt clip		8	-	13	22
			5	-	8	9
			6	-	10	9

b) Tightening Torques

Table 2-5 Tightening Torques

Bolt specification	Size of socket wrench mm	Size of inner hexagonal wrench mm	Torque Nm	
			10.9 class	8.8 class
M8	13	6	30	20
M10	16	8	70	50
M12	18	10	120	90
M14	21	12	195	140
M16	24	14	300	210
M18	27		410	300
M20	30	17	600	400
M22	34		800	550
M24	36	19	1000	700
M27	41		1500	1050
M30	46	22	1850	1450
M36	55	27	3000	2450



Note: the desired tightening torque is expressed in Nm. For example, in case of tightening the bolt or nut with a 1m long wrench, turn the tail end of wrench by a force of 120N, and create the following torques:

1m X120 N=120 Nm

In case of creating the same torque with a 0.25m wrench:

0.25m ×  =120Nm

The desired force shall be:

120 /0.25=480 N

● Maintenance of hammer crusher

The operation of hydraulic hammer crusher will accelerate the pollution and deterioration of hydraulic oil. Therefore, in comparison with the machine with a bucket, require to replace the hydraulic oil and hydraulic oil tank filter frequently, otherwise the hammer crusher, hydraulic oil pump and other components of hydraulic system may be damaged, and adopt the following recommended replacement intervals.

Table 2-6 Replacement Intervals (Hours)

Accessory	Utilizing rate	hydraulic oil	Filter element
Bucket	100%	2000	500
Hammer crusher	100%	600	100

● Maintenance under special environment conditions



Table 2-7 Maintenance under Special Environment Conditions

Operating conditions	Maintenance cautions
Mud field, rainy or snowy	Pre-operation: check if the screw plug and all the drain plugs are tightened. After-operation: clean the machine, and check if there are broken, damaged, loose or missed nut and bolt, and lubricate all the required parts immediately.
Seaside	Pre-operation: check if the screw plug and all the drain plugs are tightened. After-operation: clean the machine thoroughly with clean water to remove the salt content, and maintain the electric appliances frequently to avoid their corrosion.
Dusty air	Air filter: clean the filter elements at regular service intervals. Radiator: clean the mesh enclosure of oil cooler to avoid the blockage of radiator core. Fuel system: clean the filter elements and sieve at regular short service intervals. Electric appliances: clean them at regular intervals, especially the terminals of AC generator and starting motor.
Frosty weather	Fuel: adopt the appropriate low-temperature high-quality fuel. Lubricant: adopt the high-quality low-viscosity hydraulic oil and engine oil. Engine coolant: be sure to adopt the anti-freezing agent. Battery: charge the battery up at short regular intervals. In case of not charging the battery up, the electrolyte may be frozen. Crawler: keep the crawler clean, and park the machine on the hard ground to avoid freezing the crawler on the ground.
Stony ground	Crawler: careful operation. Check if there are broken, damaged or missed bolt and nut frequently, and loosen the crawler a little looser than usual. Working device: in case of digging the stony ground, the standard accessories may be damaged, adopt the front reinforced bucket or heavy-duty bucket.
Falling rocks	Cab: if necessary, install the cab roof support to avoid the damages of falling rocks to the machine.

- **Maintenance of engine**  
—See “Operating Instructions of Engine” in details.
- **Maintenance of air conditioner**  
—See “Operating Instructions of Air Conditioner” in details.

**List of Maintenance Periods**  
Table 2-8 List of Maintenance Periods

Item	S/N	Maintenance point		Qty	Intervals (hours)								
					8	50	100	250	500	1000	1500	2000	
Hydraulic system	1	Check the level of hydraulic oil.		1	√								
	2	Drain the oil reserve of oil tank.		1				√					
	3	Replace the hydraulic oil.										√	
	4	Replace oil suction filter		1						√			
	5	Replacement of oil tank filter		1					√				
	6	Replacement of pilot oil filter		1						√			
	7	Check of hose and pipe	Oil leak		√								
	Crack or bend, etc						√						
Fuel system	1	Drain the dirt reserve tank of fuel tank		1	√								
	2	Check of water separator		1	√								
	3	Replacement of fuel filter (second class)		2				√					
	4	Check of fuel hose	Leak or crack		√								
	Crack or bend, etc						√						
Air filtering system	1	Outer element of air filter	Clean	1	Or when the indicator goes on		√						
			Replace	1	Clean six times or after one year								
	2	Inner element of air filter	Replace	1	When replacing the outer filter elements								
Cooling system	1	Check of coolant level		1	√								
	2	Check or adjustment of fan belt tension		1	√								
	3	Replacement of coolant (anti-freeze fluid)			Twice per year								
	4	Cleaning of radiator and oil cooler core or intercooler	Inner	1	If required			√					
			Outer	1	When replacing the cooling water								
	5	Cleaning of front mesh enclosure of oil cooler		1	If required			√					
6	Cleaning of air conditioner condenser		1	If required			√						
Others	1	Check the bucket teeth for wears and loosening.			√								
	2	Adjustment of bucket connection		1	If required								
	3	Check and replacement of safety belt		1	√	Every three years (replacement)							
	4	Check the level of front window glass washing liquid.		1	If required								
	5	Check of crawler sag		2	If required								
	6	Check of air conditioner filter	Recirculation air filter	Clean	1					√			
				Replace	1	After at least six cleanings							
			Fresh air filter	Clean	1					√			
				Replace	1	After at least six cleanings							
	7	Check of air conditioner			√								
	8	Fastening of cylinder head bolt			If required								
	9	Check and adjustment of valve clearance								√			
10	Check of fuel injection timing			If required									
11	Check of starter and AC generator								√				
12	Check of bolt and nut tightening torque				★			√					



Note: ★ Maintenance is required only for the first check.

### Trouble shooting

● **Correct procedures of maintenance and check**

In order to maintain and repair the machine correctly, follow the correct maintenance and check procedures described in this manual.

- a) Check the machine before starting it every day.
  - 1) Check the controller and instruments.
  - 2) Check the levels of coolant, fuel and hydraulic oil.
  - 3) Check the hoses and pipes for leaks, twists, wears or damages.
  - 4) Make a patrol inspection of common conditions, noises or heat around the machine.
  - 5) Check the part for loosening or missing.
- 6) If anything wrong with the machine, repair it before the operation, or contact with your assigned dealer.

**Important: 1) Adopt the correct oil products, grease and anti-freeze fluid. 2) Any use of incorrect oil product, grease or sterling part will lead to the loss of product warranty. 3) Don't adjust the engine speed limiter or hydraulic system safety valve. 4) Avoid any contact of electric component with water and steam. 5) Don't disassemble the main controller, sensor or other electric components.**

- b) Check the hour meter frequently:
  - 1) Determine the time of machine check and maintenance according to the operating hours shown by the engine working hour meter.
  - 2) The intervals shown in List of Maintenance Periods are determined as per the normal operation, and maintain the machine in shorter interval in case of running the machine under the bad conditions.
  - 3) Make a periodic check and adjustment of lubrication or maintenance as per the readings of periodic maintenance meter on the inner side of tool box cover.
  - 4) When the hours of hour meter reach the replacement time of recommended lubricant and filter element, or during the periodic check every day or every month, replace the lubricant and filter element.
- c) Adopt the correct oil products, lubricant and anti-freeze fluid.

**Important: adopt the correct oil products, grease and anti-freeze fluid always, otherwise the machine will be damaged and the warranty of this machine will be lost.**

● **Trouble shooting**

- a) **Engine**

Table 2-9 Trouble shooting of engine

Trouble	Cause	Remedy
Engine rotates, but it can't be started or difficult to start.	No fuel	Add in fuel, and exhaust the air.
	Wrong fuel	Empty the oil tank, and adopt the correct fuel.
	Polluted fuel	Empty the oil tank, and add in clean fuel.
	Low capacity of battery	Charge or attach a new battery.
	Trouble of injection pump	Contact with the assigned dealer of XEM (Xugong Excavator Machinery Co., Ltd) excavator
	Trouble of preheat circuit or igniter plug	Contact with the assigned dealer of XEM excavator.
	Poor contact of circuit	Clean and fix the connection of battery and starting motor.
	Trouble of starting motor	Replace the starting motor.
	Wrong engine oil	Drain the oil, and adopt the correct oil.
	Blockage of air filter	Replace the filter elements.
	Blockage of fuel filter	Bleed the air out of fuel system, and clean the sieve of

		fuel tank.
	Low compression ratio of engine	Contact with the assigned dealer of XEM excavator.
	Dirty nozzle or incorrect operation	Contact with the assigned dealer of XEM excavator.
	Trouble of fuel cutoff linkage	Adjust or repair the linkage.
	Leakage of fuel system	Check the connection of fuel system.
	Air exists in fuel system.	Bleed the air.
	Pop-up of fuel supply pump plunger	Push down and tighten the hand wheel.
	Dirty transfer pump sieve	Clean or replace
Shot noise, abnormal running or stoppage of engine	Low level of engine oil	Add in engine oil.
	Blockage of air suction system	Clean the filter system.
	Dirty transfer pump sieve	Clean or replace
	Off-time of injection pump	Contact with the assigned dealer of XEM excavator.
	Blockage of fuel filter	Renew the filter.
	Low temperature of cooling water	Incorrect operation of thermostat or it's too cold.
	Water, dirt or air exists in fuel system	Drain the air out of fuel system, and clean the outlet sieve of fuel tank.
	Dirt or trouble of nozzle.	Contact with the assigned dealer of XEM excavator.
	Fuel cutoff linkage trouble	Adjust or repair the linkage.
The engine can't function fully.	Blockage of air filter	Replace the filter elements.
	Blockage of fuel pipe	Repair or replace the fuel pipe.
	Polluted fuel	Empty the fuel tank, clean the outlet sieve, and add in the oil again.
	Blockage of fuel filter	Replace the filter.
	Blockage of fuel tank cover vent hole	Clean or attach a new cover.
	Dirt or trouble of fuel nozzle	Contact with the assigned dealer of XEM excavator.
	Adjustment required for injection pump linkage	Contact with the assigned dealer of XEM excavator.
	Wrong fuel	Adopt the correct fuel.
	Wrong engine oil	Adopt the correct engine oil.
	Trouble of turbo charger	Contact with the assigned dealer of XEM excavator.
	Off-time of injection pump	Contact with the assigned dealer of XEM excavator.
	Blockage of emission	Remove the muffler and run the engine.
	Overheat or overcooling of engine	See below
	Trouble of engine	Contact with the assigned dealer of XEM excavator.
	Leaks of air suction or bleeding system	Contact with the assigned dealer of XEM excavator.
Overheat of engine	Low level of cooling water	Add in cooling water.
	Trouble of thermostat	Contact with the assigned dealer of XEM excavator.
	Overload of engine	Check the hydraulic safety valve.
	Wear of radiator cap	Attach a new cap.
	Blockage of radiator core and oil cooler core	Clean the radiator and oil cooler.
	Blockage of radiator mesh enclosure	Clean the mesh enclosure.
	Off-time of injection pump	Contact with the assigned dealer of XEM excavator.
	Damage of fan	Replace the fan.
	Blockage of air filter	Clean the air filter.
	Loosening of AC generator and fan belt	Tension the belt or attach a new belt.
	Wear of belt pulley	Replace the belt pulley
	Dirty cooling system pipe	Flush the cooling system.
	Trouble of thermometer or transfer unit	Contact with the assigned dealer of XEM excavator.
Overlow temperature of	Trouble of thermostat	Contact with the assigned dealer of XEM excavator.

cooling water	Trouble of thermometer or transfer unit	Contact with the assigned dealer of XEM excavator.
Low pressure of engine oil	Trouble of engine oil pump or pump drive	Contact with the assigned dealer of XEM excavator.
	Low level of engine oil	Add in engine oil.
	trouble of engine oil pressure control valve	Contact with the assigned dealer of XEM excavator.
	Blockage of oil pump suction mesh enclosure	Contact with the assigned dealer of XEM excavator.
	Blockage of oil filter	Renew the oil filter.
	Leak of engine oil	Leak check.
	Engine oil is diluted by fuel or cooling water.	Contact with the assigned dealer of XEM excavator.
	Overhigh temperature of engine	Check the cooling system.
	Wrong engine oil	Drain the oil, and adopt the correct oil.
Excessive consumption of engine oil	Wrong engine oil	Drain the oil, and adopt the correct oil.
	Leak of engine oil	Check the engine oil drain plug.
	Overheat of engine	Check the cooling system.
	Blockage of air filter	Clean the filter element or attach new filter elements.
	Wear of inner parts of engine	Contact with the assigned dealer of XEM excavator.
Excessive consumption of engine fuel	Blockage or dirt of air suction system	Clean the air suction system.
	Wrong fuel	Adopt the correct fuel.
	Dirty fuel nozzle	Contact with the assigned dealer of XEM excavator.
	Off-time of injection pump	Contact with the assigned dealer of XEM excavator.
Too black or grey exhaust fume	Wrong fuel	Empty the oil tank, and adopt the correct fuel.
	Blockage or dirt of air suction or discharge system	Clean the air suction or discharge system.
	Off-time of injection pump	Contact with the assigned dealer of XEM excavator.
	Dirty fuel nozzle or its incorrect operation	Contact with the assigned dealer of XEM excavator.
	Trouble of engine body	Contact with the assigned dealer of XEM excavator.
Failure of engine	Trouble of battery	Charge or replace.
Insufficient capacity of battery	Loose connection or corrosion	Clean, tighten or replace the battery.
	Loosening of AC generator belt	Tension the belt or attach a new belt.
	AC generator fails to charge.	Contact with the assigned dealer of XEM excavator.
	Broken fuse	Replace the fuse.
	Trouble of key switch	Replace the key switch.
Starting motor can't rotate.	Insufficient capacity of battery or damaged	Charge or replace the battery.
	Poor connection of battery circuit	Clean the connection.
	Broken fuse	Replace the fuse.
	Trouble of key switch	Contact with the assigned dealer of XEM excavator.
	Trouble of starting relay	Contact with the assigned dealer of XEM excavator.
	Trouble of starting motor magnetic coil	Contact with the assigned dealer of XEM excavator.
	Trouble of starting motor	Repair or replace the starting motor.
	The starting motor pinion is clamped in the flywheel gear.	Repair or replace starting motor.
Trouble of engine body	Contact with the assigned dealer of XEM excavator.	
Magnetic vibration of starting motor	Poor connection of battery or starting motor circuit	Clean the connection part.
	Low capacity of battery	Charge or replace battery
	Opening of starting motor magnetic "hold" coil	Contact with the assigned dealer of XEM excavator.

The starting motor rotates but it can't be started.	Disengagement of starting motor pinion with the flywheel gear	Contact with the assigned dealer of XEM excavator.
	Seizure or trouble of pinion shift mechanism	Contact with the assigned dealer of XEM excavator.
	Fracture of pinion teeth	Contact with the assigned dealer of XEM excavator.
	Fracture of flywheel gear teeth	Contact with the assigned dealer of XEM excavator.
Slow starting of engine	Inner damages or fracture of battery leads	Check and replace the leads.
	Loosening of battery or starting motor connection or corrosion	Clean and tighten the connection.
The engine bleeds white gas.	Wrong fuel.	Empty the oil tank, and adopt the correct fuel.
	Low temperature of engine	Run the engine until it becomes hot.
	Trouble or overcooling of thermostat	Contact with the assigned dealer of XEM excavator.
	Off-time of injection pump	Contact with the assigned dealer of XEM excavator.
Large noise or vibration of turbo charger	Leak of cooling water into the cylinder of engine	Contact with the assigned dealer of XEM excavator.
	Bearing is not lubricated.	Insufficient oil pressure, check the blocked oil pipe of turbo charger
	Worn bearing	Contact with your assigned dealer.
	Air leaks of engine, suction or drain pipe	Check or repair.
	Improper gap between the turbine and turbine case	Contact with the assigned dealer of XEM excavator.
Oil dripping of turbo charger joint	Breakage of turbine blade	Remove the exhaust elbow and air inlet hose, and check them.
	Damage or wear of bearing and (or) worn seal	Contact with the assigned dealer of XEM excavator, check and clean the air filter, check if the service interval of engine is proper or dirt enters into the engine.
	Overhigh pressure of crankcase	Check the vent pipe, ensure the pipe is not blocked, and clean it.
Too large resistance of turbo charger rotating member	Blockage of turbo charger return pipe at the exhaust pipe	Remove the pipe, and check or clean it.
	The combustion deposits cause the blockage of coal behind the turbine.	check or clean
	Leaks of air suction pipe cause the blockage of dirt behind the compressor wheel.	check or clean
	Overhigh temperature, unbalanced impeller, dirty oil, lack of oil or insufficient lubrication causes the seizure, dirt and wear of bearing.	Contact with the assigned dealer of XEM excavator.

b) Electric system

Table 2-10 Trouble shooting of electric system

Trouble	Cause	Remedy
Slow starting of engine	Current leakage of battery or it can't hold the charge capacity.	Replace the battery.
	"Draggle" of starting motor	Contact with the assigned dealer of XEM excavator.
	Low voltage of battery	Charge or replace battery
The starting motor continues to run after starting the engine.	Trouble of starting relay	Contact with the assigned dealer of XEM excavator.
	Suction of starting motor magnetic coil	Contact with the assigned dealer of XEM excavator.
	The starting motor can't be disconnected.	Contact with the assigned dealer of XEM excavator.
	Trouble of key switch	Contact with the assigned dealer of XEM excavator.
The charging indicator goes on during the running of engine.	Loosening or slipping of AC generator belt	Check the belt, if slipped, replace; if loose, tension.
	Low speed of engine	Adjust the speed to the specified value.
	Attached accessories cause the electric overload.	Remove the attached accessories or install higher-output AC generator.
	Loosening of battery, grounding steel strip, starting motor or AC generator, corrosion of electric connection	Check, clean or tighten the electric connection.
	Low voltage of battery	Charge or replace the battery.
	AC generator trouble	Contact with the assigned dealer of XEM excavator.
	Trouble of monitor	Contact with the assigned dealer of XEM excavator.
Fracas of AC generator	Worn driving belt	Replace the belt.
	Worn belt pulley	Replace the belt pulley and belt.
	Improper adjustment of belt pulley	Adjust the installation of AC generator
	Trouble of AC generator bearing	Loosen the belt of AC generator, and turn the belt pulley by hands. In case of feeling difficult to turn, repair AC generator.
Indicator of monitor can't go on.	Trouble of monitor	Contact with the assigned dealer of XEM excavator.
	Trouble of electric wiring	Contact with the assigned dealer of XEM excavator.
	Damaged fuse	Replace the fuse.
	Trouble of sensor.	Check the sensor.
The cooling water thermometer fails to work.	Damaged fuse	Replace the fuse.
	Trouble of thermometer	Contact with the assigned dealer of XEM excavator.
	Trouble of temperature sensor	Check the sensor of cooling water thermometer.
	Trouble of electric circuit	Contact with the assigned dealer of XEM excavator.
The automatic idling indicator goes out.	Damaged fuse	Replace the fuse.
	Trouble of automatic idling switch	Contact with the assigned dealer of XEM excavator.

The fuel meter can't work.		Damaged fuse	Replace the fuse.
		Damaged fuel meter	Contact with the assigned dealer of XEM excavator.
		Trouble of electric circuit	Contact with the assigned dealer of XEM excavator.
Working mode toggle fails to work.		Trouble of mode toggle	Contact with the assigned dealer of XEM excavator.
		Damaged electric joint	Contact with the assigned dealer of XEM excavator.
		Trouble of monitor	Contact with the assigned dealer of XEM excavator.
Fast/slow walking speed deactivates.		Trouble of walking mode switch	Contact with the assigned dealer of XEM excavator.
		Trouble of monitor	Contact with the assigned dealer of XEM excavator.
		Trouble of solenoid valve	Contact with the assigned dealer of XEM excavator.
		Damaged running motor	Contact with the assigned dealer of XEM excavator.
Automatic idling deactivates.		Damaged fuse	Replace the fuse.
		Trouble of pilot pressure switch	Contact with the assigned dealer of XEM excavator.
		Trouble of electric circuit	Contact with the assigned dealer of XEM excavator.
		Trouble of engine control motor	Contact with the assigned dealer of XEM excavator.
		Trouble of main controller	Contact with the assigned dealer of XEM excavator.
The trouble indicator flashes.	Once or brighten.	Contact with the assigned dealer of XEM excavator.	Contact with your assigned dealer.
	Twice	Abnormal current of motor	Contact with the assigned dealer of XEM excavator.
	Three times	Pause of motor action	Contact with the assigned dealer of XEM excavator.
	Four times	Motor poor in the range of action	Contact with the assigned dealer of XEM excavator.
	Five times	Broken circuit or short circuit of built-in potentiometer of motor	Contact with the assigned dealer of XEM excavator.
	Six times	Set broken circuit or short circuit of potentiometer	Contact with the assigned dealer of XEM excavator.
	Seven times	Abnormal current of magnetic coil	Contact with the assigned dealer of XEM excavator.
	Eight times	Overflow speed of engine	Contact with the assigned dealer of XEM excavator.
	Extinguish	Trouble of controller	Contact with the assigned dealer of XEM excavator.

c) Hydraulic system

Table 2-11 Trouble shooting of hydraulic system

Trouble	Cause	Remedy
Slow hydraulic function	Low level of hydraulic oil	Fill the hydraulic oil up to full scale.
	Low temperature of hydraulic oil	Preheat the machine.
	Wrong use of hydraulic oil	Empty the oil tank, and adopt the correct hydraulic oil
	Overflow speed of engine	Accelerate or contact with your assigned dealer.
	Wear of hydraulic pump	Contact with the assigned dealer of XEM excavator.
	Blockage of pump suction pipeline	Contact with the assigned dealer of XEM excavator.
Overheat of hydraulic oil	Wrong use of hydraulic oil	Adopt the correct hydraulic oil
	Air leak of pump oil suction pipeline	Contact with the assigned dealer of XEM excavator.
	Blockage of hydraulic pipeline	Contact with the assigned dealer of XEM excavator.
	Low level of hydraulic oil	Fill the hydraulic oil to full scale.



	Blockage of filter	Attach a new filter
	Wear of hydraulic pump	Contact with the assigned dealer of XEM excavator.
	Blockage of radiator or oil cooler	Clean and straighten the blade.
	Bypass of oil cooler	Contact with the assigned dealer of XEM excavator.
	Trouble of safety valve	Contact with the assigned dealer of XEM excavator.
	Polluted hydraulic oil	Drain the oil and fill it up.
	Improper adjustment of hydraulic components	Contact with the assigned dealer of XEM excavator.
Foaming hydraulic oil of	Air leak of the pipe from oil tank to pump	Contact with the assigned dealer of XEM excavator.
	Twist or depression of hydraulic pipeline	Check the pipeline.
	Wrong hydraulic oil	Adopt the correct hydraulic oil.
	Water in hydraulic oil	Replace the hydraulic oil.
	Overhigh or overflow oil level	Calibrate the oil level.
Low or no oil pressure	Wrong hydraulic oil	Adopt the correct hydraulic oil.
	Improper adjustment of hydraulic components	Contact with the assigned dealer of XEM excavator.
	No hydraulic oil in the system	Fill up the correct hydraulic oil.
	Worn hydraulic cylinder packing	Contact with the assigned dealer of XEM excavator.
	Trouble of safety valve	Contact with the assigned dealer of XEM excavator.
No hydraulic function (fracas of pump)	Wear of hydraulic pump	Contact with the assigned dealer of XEM excavator.
	Reduction of set pressure of main safety valve of control valve	Contact with the assigned dealer of XEM excavator.
	Low level of hydraulic oil	Fill up the hydraulic oil.
	Damage of oil suction pipeline or hose	Contact with the assigned dealer of XEM excavator.
	Blockage of suction filter, and air sucked in oil suction.	Clean the filter system.
The hydraulic cylinder acts but it can't lift the load.	Wear of hydraulic pump	Contact with the assigned dealer of XEM excavator.
	Low pressure of main safety valve	Contact with the assigned dealer of XEM excavator.
	Low level of hydraulic oil	Fill up the hydraulic oil.
	Blockage of suction filter	Clean the filter system.
	Leakage of pump suction pipeline	Check the oil suction pipeline.
One control lever fails to work.	Low pressure of safety valve	Contact with the assigned dealer of XEM excavator.
	Damage of pipe or hose	Repair or replace
	Loosening of hydraulic joint	Tighten.
	Damage of O-ring in the joint	Attach a new O-ring.
	hydraulic pump trouble	Contact with the assigned dealer of XEM excavator.
	Trouble of pilot valve	Contact with the assigned dealer of XEM excavator.
	Damage of pilot pipeline	Repair or replace
One hydraulic cylinder fails to work.	Control valve column is damaged or polluted by dirt.	Contact with the assigned dealer of XEM excavator.
	Damage of hydraulic pipeline	Repair or replace
	Loosening of joint	Tighten.
	Damage of O-ring in the joint	Attach a new O-ring.
	Trouble of pilot valve	Contact with the assigned dealer of XEM excavator.
	Damage of pilot pipeline	Repair or replace

One hydraulic cylinder fails to work or almost deactivates.	Leakage of hydraulic cylinder seal	Contact with the assigned dealer of XEM excavator.
	Damage of hydraulic cylinder lever	Contact with the assigned dealer of XEM excavator.
	Damage of pilot pipeline	Repair or replace
	Trouble of pilot valve	Contact with the assigned dealer of XEM excavator.
	Trouble of circuit	Contact with the assigned dealer of XEM excavator.
Two travel motors fail to work.	Trouble of center sub body	Contact with the assigned dealer of XEM excavator.
One travel motor fails to work	Trouble of travel motor	Contact with the assigned dealer of XEM excavator.
	Unreleased of brake	Contact with the assigned dealer of XEM excavator.
	Trouble of pilot valve	Contact with the assigned dealer of XEM excavator.
	Damage of pilot pipeline	Repair or replace
Unstable travel	Adjustment required for crawler	Adjust the crawler sag
	Damage of crawler guide wheel, supporting wheel or carrying wheel	Contact with the assigned dealer of XEM excavator.
	Bend of chassis frame	Contact with the assigned dealer of XEM excavator.
	Seizure of stone block or soil in the chassis frame	Remove and repair.
	Unreleased of moving brake	Contact with the assigned dealer of XEM excavator.
Rotation deactivates.	Trouble of rotary motor	Contact with the assigned dealer of XEM excavator.
	Trouble of pilot valve	Contact with the assigned dealer of XEM excavator.
Unsmooth rotation.	Trouble of rotary gear	Contact with the assigned dealer of XEM excavator.
	Trouble of rotary bearing	Contact with the assigned dealer of XEM excavator.
	Lack of grease	Add in the grease.

**Periodic replacement of parts**

In order ensure the safety of operation, be sure to check the machine at regular intervals. If any of the following parts is damaged, it may cause a severe accident or fire. The deterioration or damage of these parts is difficult to determine via a visual check, so these parts shall be replaced at the intervals shown in the table below, however, if they are found to be poor during the check, they shall be replaced before the operation of machine, regardless of the interval of replacement.

In case of replacing the hose, it’s also required to check their pipe clips for deformations, breakage or damages, and replace them according to the demands. Be sure to check all the following hoses at regular intervals, and replace or tighten any poor part as per the demands.

**Table 2-12 Periodic Replacement of Key Parts**

Part replaced at regular intervals		Replacement interval	
Engine	Fuel hose (from fuel tank to filter)	Every two years	
	Fuel hose (from fuel tank to injection pump)	Every two years	
	oil filter hose (from engine to oil filter)	Every two years	
Hydraulic system	Basic body	Oil pump inlet hose	Every two years
		Oil pump outlet hose	Every two years
		Hydraulic hose of rotation gear	Every two years
	Accessories of working device	Hose of movable arm hydraulic cylinder pipeline	Every two years
		Hose of bucket rod hydraulic cylinder pipeline	Every two years
		Hose of bucket hydraulic cylinder pipeline	Every two years
		Hose of pilot pipeline	Every two years

## Transport, storage and protection

### Transport

#### Cautions of transport

- **During the attachment of machine to the platform of truck or trailer, or removal of machine from them**

- a) During the transport of machine on the road, be sure to follow the local laws and regulations.
- b) Provide the appropriate truck or trailer for the convenience of machine transport.

- **Cautions of machine removal**

- a) Choose the firm or flat ground.
- b) Be sure to adopt the platform or slope.
- c) During the removal of machine, there must be a signalman.
- d) Choose the slow-speed mode with a travel mode toggle to avoid high-speed.
- e) The steering on the slope is very dangerous, and avoids the steering when going up or down the slope.



Fig.3-1

If the steering is required, transport the machine back to the ground or trailer platform, and drive it on the slope after rectifying the direction.

- f) In case of driving up or down the slope, don't use any other control lever other than the traction control lever.
- g) The intersection of slope top and trailer platform is convex, and drive the machine by this intersection.
- h) Avoid the possible injuries caused by the turnover of machine during the rotation of upper car.
- i) Keep the bucket rod retracted down and rotate the upper car slowly to achieve the optimum stability.
- j) Fix the frame of machine with a chain or rope.

### Road transport

During the transport of machine on the road, learn of and follow all the local laws and regulations.

- During the transport of trailer, verify the length, width, height and weight of trailer for loading the machine.

**Note: the transport weight and size may be different due to the type installed track plate or front working device.**

- Observe the conditions of transport route in advance, e.g. size, weight limit and traffic regulations. In case of disassembling the machine, meet the local specified size or weight limit.

### Removal of trailer

Remove the machine always on the firm or flat ground.

**! Note: be sure to use the platform or slope during the loading and unloading.**

- **Adopt the slope or platform.**

- a) Clean the slope or platform and trailer platform thoroughly before loading and unloading, the risk of slipping may exist on them with oil dirt, soil or ice.
- b) During the use of slope or platform, place the damp block under the wheel of front body and trailer.
- c) The slope or platform must have enough width, length and strength to make the inclination angle of slope or the gradient of platform below 15°.

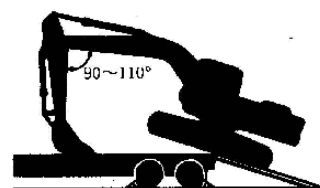

Fig.3-2

- **Loading**

- a) The direction of machine is down: with front-end working device: move the working device forward with it placed on front body; without front-end working device: travel in reverse direction as shown in above figure.

- b) The centerline of machine shall be on the centerline of trailer.

- c) Drive the machine slowly on the slope. With front-end working device:

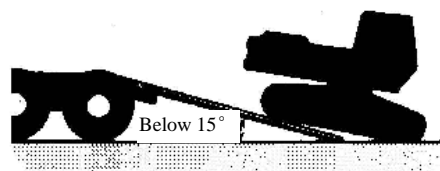

Fig.3-3

- 1) Support the plane bucket on the trailer, and the angle between

bucket rod and movable arm should be within 90° to 110°.

- 2) Upon inclining the machine to trailer platform, support the bucket to the trailer, move the machine slowly forward, until the whole crawler moves on the trailer and contacts the platform.

- 3) Lift the bucket slightly, retract the bucket rod and make it under the machine, and rotate the upper car slowly by 180°.



Fig. 3-4

- 4) Fall the bucket to sleeper.
- d) Stop the engine, and remove the key from key switch.
- e) Move the control lever several times until the whole pressure of hydraulic cylinder is released.
- f) Pull the safety locking rod to LOCK (lock).
- g) Close the window, skylight and door of cab, and cover the air outlet to prevent the wind and rain from entering into it.



Note: in the cold weather, be sure to heat the machine before loading/unloading it.



**Transport**



Note: tie the chain or rope to the frame of machine, and don't make the chain or rope pass through or pressed on the hydraulic pipe or hose.

- a) Place the damp blocks before and behind the crawler to fix the machine.
- b) Fix four corners of machine and front-end working device to the trailer with a chain or rope.



**Unloading**



Note: make the intersection of trailer platform rear end and slope convex, and drive the machine by it carefully.

**Important: avoid any possible damage of front-end working device. During the unloading, keep the angle between the bucket rod and movable arm within 90° to 110° always, retract the bucket rod, and any unloading may cause the damages to machine.**

- a) Upon moving the tail end of machine through the trailer to the slope or platform, support the bucket plane on the ground, and make the angle between bucket rod and movable arm within 90° to 110°.

**Important: avoid any possible damage of hydraulic cylinder, and avoid any fierce collision of bucket to the ground.**

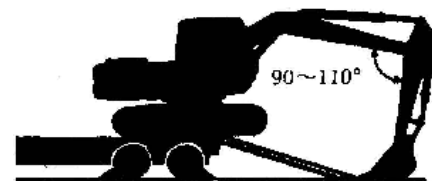

Fig. 3-5

- b) Place the bucket on the ground before the machine starts to incline forward.
- c) During the forward movement of machine, lift the movable arm and stretch the bucket rod until the machine drives fully under the slope or platform.



Fig. 3-6



**Lifting method of machine**



- 1) Lifting steel rope and other lifting tools may be broken, which results in the serious injury of person. Don't use any damaged or aged steel rope or lifting tool.
- 2) For correct lifting methods, types or sizes of lifting steel rope and lifting tools, contact with the assigned dealer.
- 3) Pull the safety locking rod to LOCK (lock), and avoid any unexpected movement of machine during the lifting.
- 4) Incorrect lifting methods and incorrect mounting of steel rope will cause the movement of machine during the lifting, which results in the damages to machine and injuries to the persons.
- 5) Don't lift the machine rapidly, otherwise the lifting steel rope and lifting tools will be overloaded and may lead to their fracture.
- 6) Don't let any person approachable to the lifted machine or walk under it.
- 7) The gravity center marked on the machine is for the machine of standard specifications, but the actual gravity center will be changed as per the type of installed accessory or chosen device and their position. Therefore, ensure the balance of machine can't be lost in case of lifting the

**machine.**

For the bucket rod and bucket hydraulic cylinder that are fully extended, fall the movable arm until the bucket contacts the ground.

- a) Pull the safety locking rod to LOCK (lock).
- b) Stop the engine, and remove the key from key switch.
- c) Adopt the steel rope and supporting rod with enough length, make them not contact the machine during the lifting. Wrap some protective material around the steel rope or supporting rod as per the demands to avoid the damages to machine.
- d) Drive the crane in proper lifting position.
- e) As shown in Fig.3-7, make the steel rope pass under the chassis frame on both sides, and attach it to the crane.

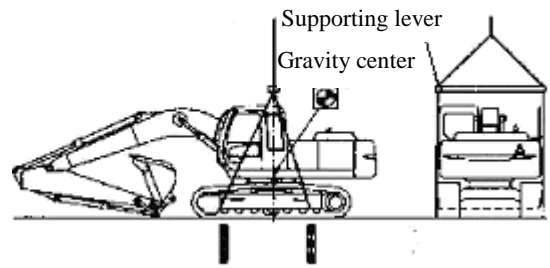

Fig. 3-7

## Storage and protection

### Daily and short-term storage and protection

- Check the machine, repair the worn and damaged parts. If necessary, attach new parts.
- Clean the air filter element.
- If possible, retract all the hydraulic cylinders; if impossible, apply the grease to the exposed rod of hydraulic cylinder.
- Lubricate all the lubrication points.
- Place the crawler on the long and stable damp block.
- Clean the machine.
- After charging the battery up, remove the battery and store it at dry and safe place. If not, separate the connection of battery negative-pole cable on the wiring terminal (-).
- Add the anti-rust agent into engine coolant. In winter, adopt the anti-freezing agent or drain the coolant off. If the cooling system is emptied, be sure to hang a nameplate “No Water of Radiator” in conspicuous position.
- Loosen the belts of AC generator and cooling fan.
- Apply the paint to desired positions to avoid rusting.
- Store the machine at dry and safe place. In case of storing it outdoor, adopt the water shield.

### Long-term storage

- Storage place
  - a) Commonly store in the ventilated and dry warehouse.
  - b) If the device is stored in open air, park it on the concrete ground easy to drain the water, cover and fix the canvas or hood, and store it at the place that can't be invaded by natural disaster and without corrosive or harmful substance or gas.
- Storage
  - a) Use the hydraulic functions of moving, rotation and digging twice to three times every month to lubricate all the parts. Check the level of coolant and lubrication state before the operation.
  - b) Check the appearance quality, protection side and anti-corrosion substances, etc at regular intervals.

### Use preparation after storage

- Remove the coverings.
- Remove the protective substances painted on the exposed part.
- Charge the battery, mount or connect it.
- After draining the oil of engine crankcase, renew the oil.
- After draining the gear oil in the rotary and traction reducer, renew the gear oil.
- Drain the inclusions and mixed water out of the hydraulic oil tank and fuel tank.
- Apply the grease to each hinged position.
- Fill in the coolant as per the specification.
- For the check before the operation, refer to the relevant regulations of operation.



### Technical specifications

#### Product specification

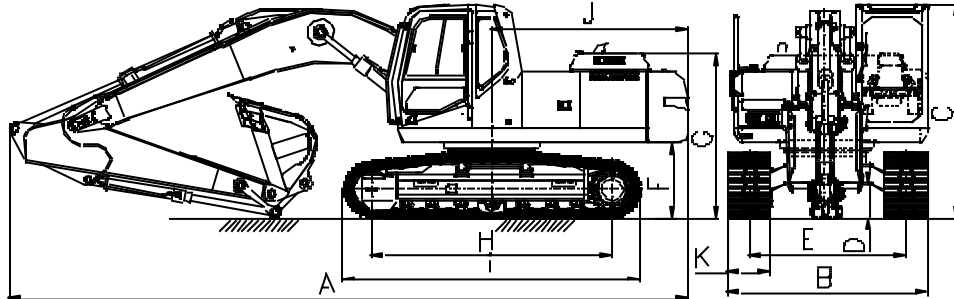

Model		XE210C	XE210C3VII	XE210C2	XE210C2VII
Item					
Operation configuration under standard configuration		2.91m Bucket lever	2.91m Bucket lever	2.91m Bucket lever	2.91m Bucket lever
Kerb mass, kg		20850~21450	20850~21450	20850~21450	20850~21450
Standard bucket capacity, m <sup>3</sup>		0.8~0.91	0.8~0.91	0.8~0.91	0.8~0.91
Engine	Model	CumminsQSB6.7	CumminsQSB6.7	CumminsB5.9	CumminsB5.9
	Rated power, kW	116	116	112	112
	Rated speed, r/min	2000	2000	1950	1950
A: Total length (transport), mm		9500~9550	9500~9550	9500~9550	9500~9550
B: Total width (transport), mm		2800~3000	2800~3000	2800~3000	2800~3000
C: Cab height (transport), mm		2950~3100	2950~3100	2950~3100	2950~3100
D: Minimum ground clearance, mm		460~500	460~500	460~500	460~500
E: Crawler track, mm		2180~2400	2180~2400	2180~2400	2180~2400
F: Get-on ground clearance, mm		1030~1085	1030~1085	1030~1085	1030~1085
G: Height of engine cover, mm		2200~2300	2200~2300	2200~2300	2200~2300
H: Distance between the centers of driving wheel and guide wheel, mm		3350~3480	3350~3480	3350~3480	3350~3480
J: Rotating radius of tail, mm		2750	2750	2750	2750
K: Width of track plate, mm		600(three grousers track plate)			
Grounding pressure, kPa		47.3	47.3	46.3	46.3
Maximum rotary speed, r/min		12.5	12.5	12.5	12.5
Max. traveling speed (fast/slow), km/h		5.5/3.3	5.5/3.3	5.5/3.3	5.5/3.3
Gradeability, °		≤35 (70%)			

Operation range

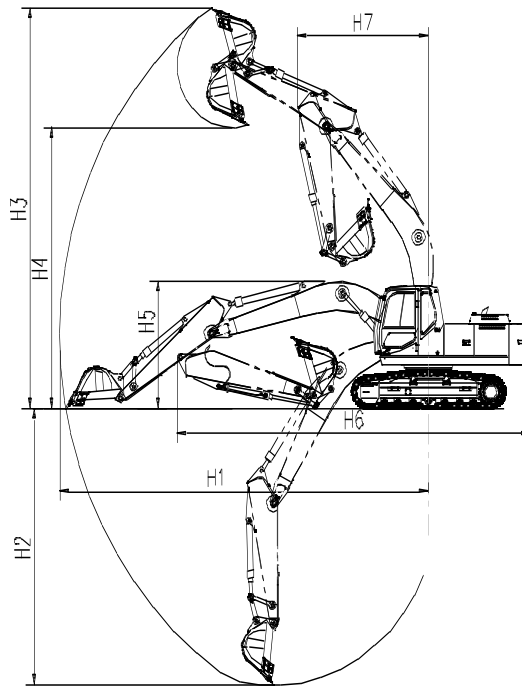

Item	Model	XE210C/XE210C3VII/XE210C2/XE210C2VII	
		2.53m Bucket Lever	2.91m Bucket Lever
H1: maximum digging radius, mm		9680	9925
H2: maximum digging depth, mm		6280	6655
H3: maximum digging height, mm		9745	9640
H4: maximum unloading height, mm		6860	6800
H5: transport height, mm		2985	2985
H6: total transport length, mm		9520	9520
H7: minimum rotary radius, mm		3530	3530

### Hydraulic System Schematic

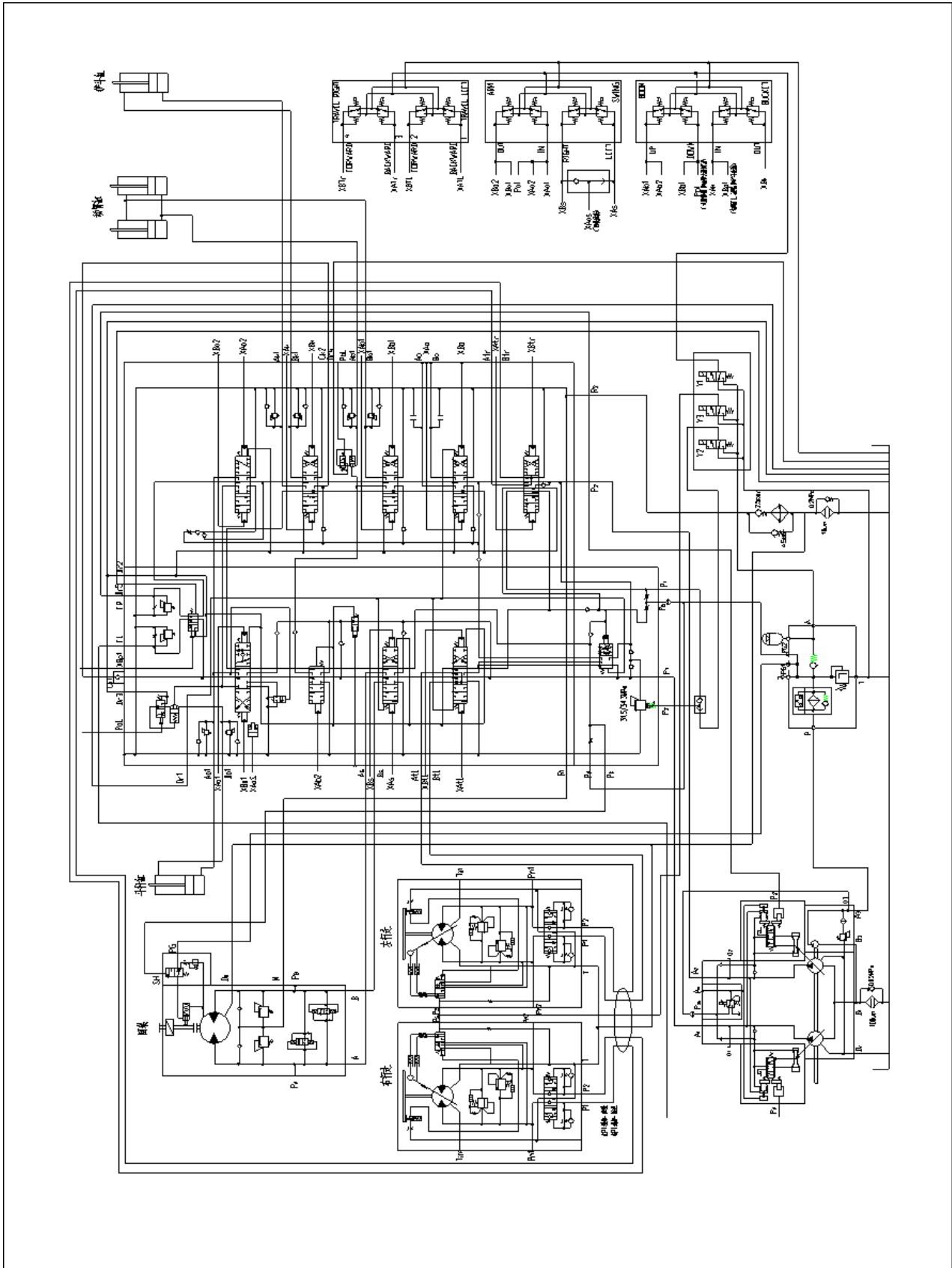

## Appendix

### Crawler type and application

Choosing the track shoe meet the operating requirements.

According to the floatability and grounding pressure to choose the width of the track shoe, choosing the narrowest track shoe possibly. If the used track shoe is wider than needed, it will increase the load of the track shoe, and lead the track bend, link broken pin-axis broken, loosen of the track shoe and other kinds of problems.

List 4-3 Crawler use table

Type	Use	Notices when using
A	Stony ground, riverbed, common earth	If the ground has big obstacles, like cobble, down-tree and rough ground, using the low speed to travel.
B	Common earth, and soft ground	Only can use the high speed and medium speed on the level ground; if passing the obstacles can not be avoided, slow down the machine and use the half speed of the low speed to travel; can not be used on the rough ground with cobble and down-tree.
C	Extra-soft ground (marshland ground)	Only use this type when the machine sink and the places where the type A and B can not be used.

List 4-4 Track shoe type table

	XE210C/XE210C3VII/XE210C2/XE210C2VII	
	Technical specification	Type
Standard	600mm three grousers track shoe	A
Selective purchasing	700mm three grousers track shoe	B
Selective purchasing	800mm three grousers track shoe	C

 **Attention:** 700, 800mm width track shoe can not be used on the ground with lots of gravels and stones.

### Bucket type and application

List 4-5 Bucket application table

Bucket type	Bucket capacity (m <sup>3</sup> ) (Pileup)	XE210C/XE210C3VII/XE210C2/XE210C2VII	
		2.52m Bucket Lever	2.91m Bucket Lever
Strengthened bucket	0.8	△	△
Strengthened bucket	0.91	△	△
Strengthened bucket	1.0	△	×
Strengthened bucket	1.1	×	×
Light load bucket	1.0	○	○
Light load bucket	1.2	×	×
Rock bucket	0.7	■	■
Rock bucket	0.8	■	■
Rock bucket	0.9	■	×
Rock bucket	1.0	×	×



**Notice:** the meanings of the symbols on the above table.

- : Light load digging
- : Heavy load digging
- ×: Can not be used

- Application type
  - Heavy load digging: digging or loading mountain gravel, explosion stone, hard clay, soft stone and so on.
  - Common digging: digging or loading sand, gravel, clay and common earth.
  - Light load digging: digging or loading dry and incompact earth, sand, mud and so on. Their volume density is required below 1600kg/m<sup>3</sup>.

**Importance:** using the improper bucket may lead serious damage of the boom, arm, hydraulic cylinders and other working device elements.

- For digging or loading hard soil or stone, suggested to use the rock bucket with high intensity and high degree anti-wear ability.

### Hammer-type Knapper (Optional)

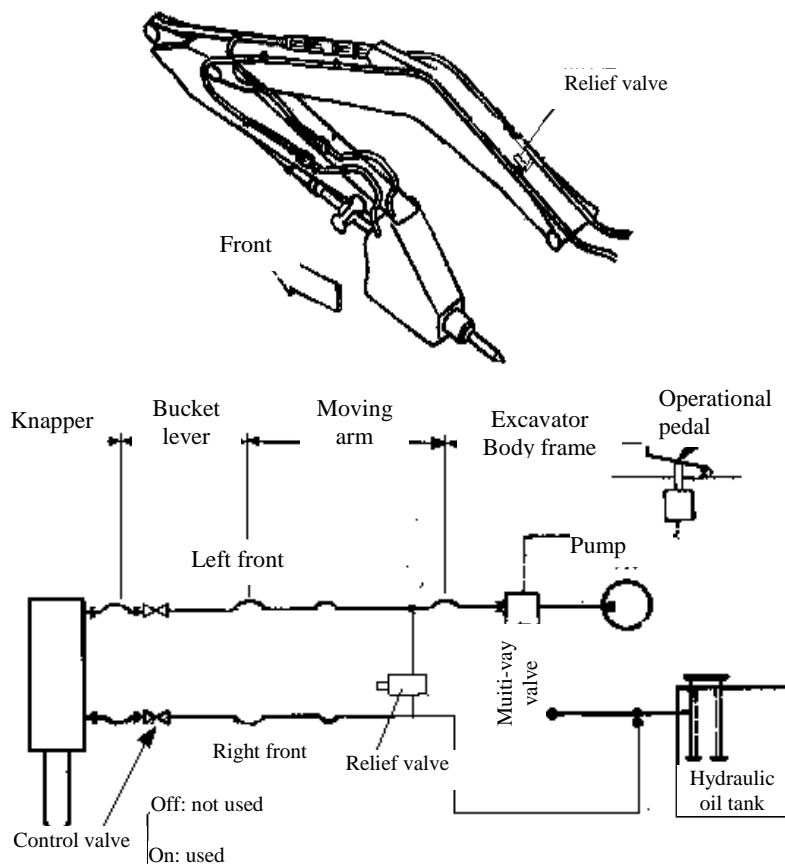

Fig. 1-2 Drawing of hammer-style knapper

The operator must choose proper hammer-style knapper for the equipment.

Before installing the knapper onto scoop lever, please read carefully this book and operational manual of hammer-style knapper and verify or check it according to the requirement. The installment of knapper tubing should refer to the above picture.

**Important: when connecting tubes of hammer-style knapper, pay more attention to: 1) while changing the bucket or scoop into knapper, don't let the dirt enter hydraulic system.2) when the knapper is not in use, lid should be placed on the tube inlet on the top of scoop lever and the plug should be put on the hose end of the knapper to prevent the dirt into the system. While standby lid and plug must be contained in toolkit for the convenience of usage.3) after the connection, check the sealing of connection to see if there is any oil leakage or flexibility of pipe connectors.**

- Weight of hammer-style knapper
- a) When the components other than the standard bucket is installed on the machine, the stability of machine may change, for the heavy parts will not only affect the controlling ability, but also reduce the stability of the machine, leading to the problem of safety possibly.

- b) Before installing hydraulic hammer-style knapper, make sure to take the controlling ability of the knapper into consideration and refer to the following list to choose hammer-style knapper.

List 1-1 Permitted weight of hammer-style knapper

Basic Machine		Hammer-style knapper	
Type	Bucket Lever	Standard Weight, kg	Max. Weight, kg
XE210C		1500	1750
XE210C3VII	Standard	1500	1750
XE210C2		1500	1750
XE210C2VII		1500	1750

- c) When choosing the hammer-style knapper, weight is not the only considered factor, instead, “SPECIFICATION LIST OF HAMMER-STYLE KNAPPER” should be referred to choose the best.
- d) Hammer-style knapper with too big installment length should be avoided, which may lead to the damage on the knapper.
- e) While putting on the knapper with the max. weight listed above make sure to stand in the front or at the rear of the machine, meanwhile try your best not to work at the max. working radius of the machine.

● Specification of hammer-style knapper

The following list shows some hammer-style knapper, which can be fixed on Xugong excavator. Before the adoption, please inquire the dealer of hammer-style knapper in earnest.

When using the parts other than the standard bucket, the load on machine body normally is bigger than that with the bucket in use. If the operation is unsuited, it will damage the parts even the machine body. So please read all this book to prevent the happening of such accident.

List 1-2 Specification List of Hammer-style Knapper (1)

Type of Excavator	XE210C				
Knapper Producer	Korea Shuishan	Korea Gongbing	Japan Guhe	Japan Dongkong	Germany KRUPP
Type of Kanpper	SB81N	GB220E	F20	TNB14E	HM960CS
Weight, kg	1500	1620	1430	1487	1500
Oil Capacity, L / min	100~150	125~150	125~150	130~170	130~170
Operational Pressure, MPa	15.7~17.7	15.7~17.7	15.7~17.7	12.7~16.7	11.8~13.7
Designed pressure of valve, MPa	17.7	17.7	17.7	17.7	16.7

List 1-3 Specification List of Hammer-style Knapper (2)

Type of Excavator	XE230, XE260C				
Knapper Producer	Korea Shuishan	Korea Gongbing	Japan Dongkong	Japan Guhe	Germany KRUPP
Type of Knapper	SB81	GB220E	TNB-150LU	F20	HM960CS
Weight, kg	1740	1620	1678	1430	1500
Oil Capacity, L / min	120~150	125~150	160~200	125~150	130~170
Operational Pressure, MPa	15.7~17.7	15.7~17.7	12.7~16.7	15.7~17.7	11.8~13.7
Designed Pressure of Valve, MPa	17.7	17.7	17.7	17.7	16.7



### Weight of work load

**Note:** the weight is an approximate value of estimated average volume and capacity.

Table 4-6 Table of Material Density

Material	Low density ≤1100kg/m <sup>3</sup>	Intermediate density ≤1600kg/m <sup>3</sup>	High density ≤2000kg/m <sup>3</sup>
Charcoal	400		
Coke	500		
Coal, asphalt	880		
Coal, stone coal	900		
Dry ball clay	1000		
Wet clay of raw subgrade			1750
Dry particles of common concrete		1500	
Dolomite fragments		1500	
Dry or soft soil		1200	
Firm and dry soil		1500	
Wet muddy soil			1750
Burned lime paste (hot powder)	960		
3" crushed lime paste		1500	
Overstacked dry gravel fragments			1800
Overstacked wet gravel fragments			1900
At least 2-class limestone		1300	
Crushed limestone		1500	
Good limestone		1600	
Rock phosphate		1300	
Salt	930		
Small-density snow	530		
Dry and soft sand		1500	
Overstacked wet sand			1900
Broken shale		1400	
Broken sulphur	530		

XUGONG EXCAVATOR MACHINERY CO., LTD  
ADD: No.28 Donghuan Industrial Area, Xuzhou Economic  
Development Zone, Jiangsu, China  
Postcode:221004  
Sale tel:0516-87870116  
Fax: 0516-87870118  
Service tel:0516-87870111  
Fax: 0516-87870117  
Spare parts tel:0516-87870133  
<http://www.xcmg.com>

First version in 2011