

Operation & Maintenance Manual

PC160-6K PC180LC-6K PC180NLC-6K PC200EN-6K PC200EL-6K HYDRAULIC EXCAVATOR

	PC160-6K	- K30001	
SERIAL NUMBERS	PC180LC-6K	- K30001	AND UP
	PC180NLC-6K	- K30001	
	PC200EN-6K	- K30001	
	PC200EL-6K	- K30001	



— WARNING —

Unsafe use of this machine may cause serious injury or death. Operators and maintenance personnel must read this manual before operating or maintaining this machine. This manual should be kept inside the cab for reference and periodically reviewed by all personnel who will come into contact with the machine.

KOMATSU

1. FOREWORD

This manual provides rules and guidelines which will help you use this machine safely and effectively. Keep this manual handy and have all personnel read it periodically. If this manual has been lost or has become dirty and can not be read, request a replacement manual from Komatsu or your Komatsu distributor.

If you sell the machine, be sure to give this manual to the new owners.

Continuing improvements in the design of this machine can lead to changes in detail which may not be reflected in this manual. Consult Komatsu or your Komatsu distributor for the latest available information for your machine or for questions regarding information in this manual.

WARNING

- **This operation & maintenance manual may contain attachments and optional equipment that are not available in your area. Please consult your local Komatsu distributor for those items you require.**
- **This machine complies with EC directive (89/392/EEC).
Machines complying with this directive display the CE mark**
- **Improper operation and maintenance of this machine can be hazardous and could result in serious injury or death.**
- **Operators and maintenance personnel should read this manual thoroughly before beginning operation or maintenance.**
- **Some actions involved in operation and maintenance of the machine can cause a serious accident, if they are not done in a manner described in this manual.**
- **The procedures and precautions given in this manual apply only to intended uses of the machine. If you use your machine for any unintended uses that are not specifically prohibited, you must be sure that it is safe for you and others. In no event should you or others engage in prohibited uses or actions as described in this manual.**
- **Komatsu delivers machines that comply with all applicable regulations and standards of the country to which it has been shipped. If this machine has been purchased in another country or purchased from someone in another country, it may lack certain safety devices and specifications that are necessary for use in your country. If there is any question about whether your product complies with the applicable standards and regulations of your country, consult Komatsu or your Komatsu distributor before operating the machine.**
- **The description of safety is given in SAFETY INFORMATION on page 0-2 and in SAFETY from page 1-1.**

2. SAFETY INFORMATION

2.1 SAFETY MESSAGES

Most accidents are caused by the failure to follow fundamental safety rules for the operation and maintenance of machines.

To avoid accidents, read, understand and follow all precautions and warnings in this manual and on the machine before performing operation and maintenance.

To identify hazards on the machine pictorial decals are used (see POSITION FOR ATTACHING SAFETY LABELS).

-  **RED WARNING TRIANGLE** - This is used on safety labels where there is a high probability of serious injury or death if the hazard is not avoided. These safety messages or labels usually describe precautions that must be taken to avoid the hazard. Failure to avoid this hazard may also result in serious damage to the machine.

-  **ORANGE WARNING TRIANGLE** - This is used on safety labels where there is a potentially dangerous situation which could result in serious injury or death if the hazard is not avoided. These safety messages or labels usually describe precautions that must be taken to avoid the hazard. Failure to avoid this hazard may also result in serious damage of the machine

-  **YELLOW SAFETY TRIANGLE** - This is used on safety labels for hazards which could result in minor or moderate injury if the hazard is not avoided. This word might also be used for a hazard where the only result could be damage to the machine.

- NOTICE** - This word is used for precautions that must be taken to avoid actions which could shorten the life of the machine.

Safety precautions are described in SAFETY from page 1-1.

Komatsu cannot predict every circumstance that might involve a potential hazard in operation and maintenance. Therefore the safety message in this manual and on the machine may not include all possible safety precautions. If any procedures or actions not specifically recommended or allowed in this manual are used, you must be sure that you and others can do such procedures and actions safely and without damaging the machine. If you are unsure about the safety of some procedures, contact Komatsu or your Komatsu distributor.

2.2 NOISE

PC160/180NLC/180LC

Operator ears noise value
(Sound pressure level)

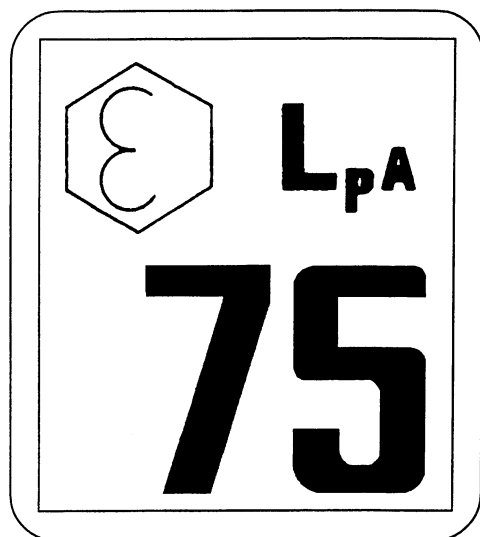

Ambient noise value
(Sound power level)

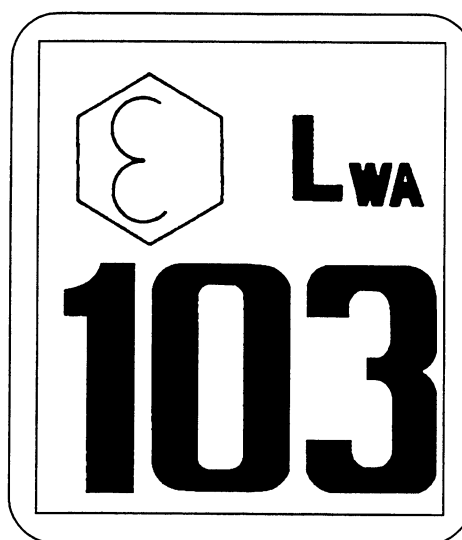

Noise level indicated is the guaranteed value as specified in the directive 86/662/EEC

2.3 VIBRATION

- The weighted root mean square acceleration value to which the operator's arms are subjected does not exceed 2.5 m/s
- The weighted root mean square acceleration value to which the operator's body is subjected does not exceed 0.5 m/s

These results were obtained by accelerometers during trench digging.

2.2 NOISE

PC200EN/PC200EL

Operator ears noise value
(Sound pressure level)

Ambient noise value
(Sound power level)

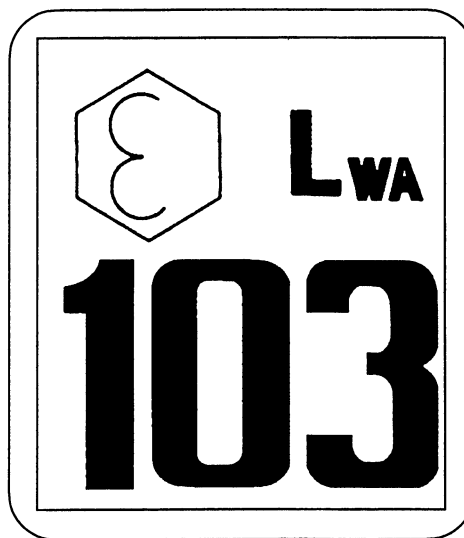
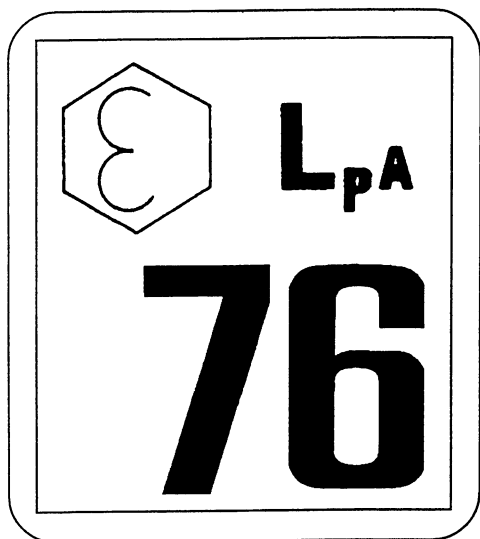

Noise level indicated is the guaranteed value as specified in the directive 86/662/EEC

2.3 VIBRATION

- The weighted root mean square acceleration value to which the operator's arms are subjected does not exceed 2.5 m/s
- The weighted root mean square acceleration value to which the operator's body is subjected does not exceed 0.5 m/s

These results were obtained by accelerometers during trench digging.

3. INTRODUCTION

3.1 INTENDED USE

This Komatsu HYDRAULIC EXCAVATOR is designed to be used mainly for the following work:

- Digging
- Smoothing work
- Ditching work
- Loading work

See the section 12.14 "WORK POSSIBLE USING HYDRAULIC EXCAVATOR" for further details

3.2 FEATURES

- This Komatsu HYDRAULIC EXCAVATOR is equipped with various controls based on an advanced electronics system.
- The monitor panel greatly facilitates daily maintenance and self-diagnosis.
- Working mode, travel speed and swing priority are selectable.
- Digging and lifting force can be increased by light-touch control. (For details, see operation section.)
- Adjustable wrist control levers make operations smooth and easy.
- Fresh filtered air heater assures comfortable operation. (Air conditioner option)
- Low noise level and smart urban style design and colouring.
- Superb operation performance provided by powerful engine and high-performance hydraulic pump.
- Low fuel consumption controlled by an electronic control system provides an environment-friendly machine.

3.3 BREAKING IN YOUR NEW MACHINE

Your Komatsu machine has been thoroughly adjusted and tested before shipment.

However, operating the machine under severe conditions at the beginning can adversely affect the performance and shorten the machine life.

Be sure to break in the machine for the initial 100 hours (as indicated by the hour meter.)

During breaking in:

- Idle the engine for 5 minutes after starting it up.
- Avoid operation with heavy loads or at high speeds.
- Sudden starting or acceleration, unnecessarily abrupt braking and sharp turning should be avoided except in cases of emergency.

Additionally for the first 20 hours

- Avoid operating engine for prolonged periods at constant speed (including idle.)
- Avoid high speed travelling for periods of more than 5 minutes.

Pay particular attention to oil pressure and temperature indicators & check coolant and oil levels frequently during breaking in.

The precautions given in this manual for operating, maintenance, and safety procedures are only those that apply when this product is used for the specified purpose. If the machine is used for a purpose that is not listed in this manual, Komatsu cannot bear any responsibility for safety. All consideration of safety in such operations is the responsibility of the user.

Operations that are prohibited in this manual must never be carried out under any circumstances.

4. LOCATION OF PLATES, TABLE TO ENTER SERIAL NO. AND DISTRIBUTOR

4.1 MACHINE SERIAL NO. PLATE POSITION

On the front bottom right of the operator's cab

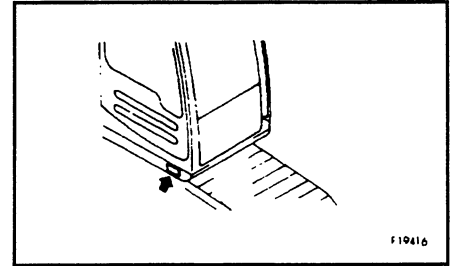

4.2 ENGINE SERIAL NO. PLATE POSITION

On the gear case front corner.

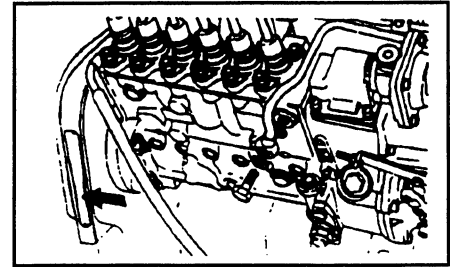

4.3 TABLE TO ENTER SERIAL NO. AND DISTRIBUTOR

Machine serial No.:	
Engine serial No.:	
Manufactureres name:	Komatsu UK Ltd
Address	Durham Road Birtley Chester-Le-Street County Durham DH32QX United Kingdom
Distributor	
Address	Phone

4.4 MACHINE SERIAL PLATE.

CE	MODEL	<input type="text"/>
	SERIAL No	<input type="text"/>
	MANUFACTURING YEAR	<input type="text"/>
	WEIGHT	<input type="text"/>
	ENGINE POWER	<input type="text"/>
	MANUFACTURER	
Produced by Komatsu UK Ltd. for Komatsu Ltd, Tokyo, Japan.		

5. CONTENTS

1. Foreword	0-1
2. Safety information	0-2
3. Introduction	0-4
4. Location of plates, table to enter serial No. and distributor	0-5

SAFETY

6. General Precautions	1-2
7. Precautions during operation	1-8
7.1 Before starting engine	1-8
7.2 Operating machine	1-10
7.3 Transportation	1-15
7.4 Battery	1-16
7.5 Towing	1-17
7.6 Bucket with hook	1-18
8. Precautions for maintenance	1-21
8.1 Before carrying out maintenance	1-21
8.2 During maintenance	1-24
9. Position for attaching safety labels	1-28

OPERATION

10. General view	
10.1 General view of machine	2-2
10.2 General view of controls and gauges	2-3
11. Explanation of components	
11.1 Machine monitor	2-4
11.2 Switches	2-15
11.3 Control levers, pedals	2-19
11.4 Roof hatch	2-24
11.5 Front window	2-25
11.6 Door lock	2-27
11.7 Cap, cover with lock	2-28
11.8 Luggage box	2-29
11.9 Ashtray	2-29
11.10 Heater	2-29
11.11 Air conditioner	2-30
11.12 Car radio	2-33
11.13 Fuse	2-34
11.14 Fusible link	2-35
11.15 Controllers	2-35
11.16 Tool box	2-35
11.17 Refuelling pump	2-35
11.18 Handling the accumulator	2-36

12. Operation	
12.1 Check before starting engine	2-38
12.2 Starting engine	2-48
12.3 Operations and checks after starting engine	2-51
12.4 Moving machine off	2-57
12.5 Steering machine	2-60
12.6 Stopping machine	2-62
12.7 Swinging	2-63
12.8 Operation of work equipment	2-64
12.9 Working mode selection	2-65
12.10 Prohibitions for operation	2-67
12.11 Precaution for operation	2-69
12.12 Precaution when travelling up or down hills	2-70
12.13 How to escape from mud	2-72
12.14 Work possible using hydraulic excavator	2-73
12.15 Replacement and inversion of bucket	2-74
12.16 Parking the machine	2-76
12.17 Check after finishing work	2-77
12.18 Stopping engine	2-78
12.19 Check after stopping engine	2-79
12.20 Locking	2-79
12.21 Overload warning device	2-79
13 Transportation	
13.1 Loading, unloading work	2-80
13.2 Precautions for loading	2-82
13.3 Precautions for transportation	2-83
13.4 Lifting the machine	2-83
14. Cold weather operation	
14.1 Precaution for low temperature	2-85
14.2 Precautions after completion of work	2-86
14.3 After cold weather	2-86
15. Long-term storage	
15.1 Before storage	2-87
15.2 During storage	2-88
15.3 After storage	2-88
15.4 Starting machine after long-term storage	2-88
16. Troubleshooting	
16.1 Phenomena that are not failures	2-89
16.2 Method of towing machine	2-89
16.3 Using method for light-weight towing hole	2-89
16.4 Precautions on particular jobsites	2-90
16.5 If battery is discharged	2-90
16.6 Other trouble	2-94

MAINTENANCE

17. Guides to maintenance	3-2
18. Outlines of service	3-5
18.1 Outline of oil, fuel, coolant	3-5
18.2 Outline of electric system	3-9
18.3 Outline of hydraulic system	3-10
19. Wear parts list	3-11
20. Use of fuel, coolant and lubricants according to ambient temperature	3-12
21. Standard tightening torques for bolts and nuts	3-16
21.1 Introduction of necessary tools	3-16
21.2 Torque list	3-17
22. Periodic replacement of safety critical parts	3-18
23. Maintenance schedule chart	3-20
23.1 Maintenance schedule chart	3-20
23.2 Maintenance interval when using hydraulic breaker	3-22
24. Service procedure	3-23
24.1 When required	3-24
24.2 Check before starting	3-45
24.3 Every 100 hours service	3-51
24.4 Every 250 hours service	3-54
24.5 Every 500 hours service	3-61
24.6 Every 1000 hours service	3-67
24.7 Every 2000 hours service	3-73
24.8 Every 4000 hours	3-79

SPECIFICATIONS

25. SPECIFICATIONS	4-2
25.1 Machine specifications	4-2
25.2 Explanation of lifting capacity chart	4-5

OPTIONS AND ATTACHMENTS

26	General Precautions	5-2
26.1	General precautions related to safety	5-2
26.2	Precautions when installing attachments	5-3
27.	Handling bucket with hook	5-4
27.1	Checking for damage to bucket with hook	5-4
27.2	Prohibited operations	5-4
27.3	Precautions during operation	5-4
28	Machine ready for attachments	5-5
28.1	Explanation of components	5-5
28.2	Hydraulic circuit	5-7
28.3	Attachment mounting / dismounting procedure	5-9
28.4	Operation	5-11
28.5	Long-term storage	5-12
28.6	Specifications	5-12
29.	Introduction of attachments	5-13
29.1	Specification, use	5-13
29.2	Attachment installing combination table	5-14
29.3	Selection of track shoes	5-15
29.4	Selection of bucket teeth	5-16
29.5	Handling trapezoidal bucket	5-17
29.6	Handling extension arm	5-18
30.	Extending machine service life	5-19
30.1	Hydraulic breaker	5-19
30.2	Power ripper	5-22
30.3	Fork grab	5-23
30.4	Grapple bucket	5-24
30.5	Scrap grapple	5-25
30.6	Crusher & cutter	5-26
30.7	Hydraulic pile driver	5-27
30.8	Hydraulic excavator with multi-purpose crane	5-28

SAFETY

 **WARNING**

Read and follow all safety precautions. Failure to do so may result in serious injury or death.

This safety section also contains precautions for optional equipment and attachments.

6. GENERAL PRECAUTIONS

⚠ WARNING: For reasons of safety, always follow these safety precautions.

SAFETY RULES

- ONLY trained and authorised personnel can operate and maintain the machine.
- Follow all safety rules, precautions and instructions when operating or performing maintenance on the machine.
- When working with another operator or a person on worksite traffic duty, be sure all personnel understand all hand signals that are to be used.

SAFETY FEATURES

- Be sure all guards and covers are in their proper position. Have guards and covers repaired if damaged.
- Use safety features such as safety lock lever properly.
- NEVER remove any safety features. ALWAYS keep them in good operating condition.
Safety lever → See 12.16 “PARKING THE MACHINE”.
- Improper use of safety features could result in serious bodily injury or death.

CLOTHING AND PERSONAL PROTECTIVE ITEMS

- Avoid loose clothing, jewellery, and loose long hair. They can catch on controls or in moving parts and cause serious injury or death. Also, do not wear oily cloths because they are flammable.
- Wear a hard hat, safety glasses, safety shoes, mask or gloves when operating or maintaining the machine. Always wear safety goggles, hard hat and heavy gloves if your job involves scattering metal chips or minute materials <—> this is so particularly when driving pins with a hammer and when cleaning the air cleaner element with compressed air.
Check also that there is no one near the machine.
Driving in pins, See → 12.15 “REPLACEMENT AND INVERSION OF BUCKET’.
Cleaning of air cleaner element, See → 24.1 “WHEN REQUIRED” in service procedure.

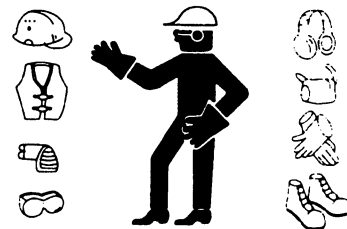

WARNING: Failure to follow these safety precautions may lead to a serious accident.

UNAUTHORISED MODIFICATION

- Any modification made without authorisation from Komatsu can create hazards.
- Before making a modification, consult your Komatsu distributor. Komatsu will not be responsible for any injury or damage caused by any unauthorised modification.

ALWAYS APPLY LOCK WHEN LEAVING OPERATOR'S SEAT

- When standing up from the operator's seat, always place the safety lock lever securely in the LOCK position. If you accidentally touch the travel or swing lever when they are not locked, the work equipment may suddenly move and cause serious injury or damage.
- When leaving the machine, lower the work equipment completely to the ground, set the safety lock lever to the LOCK position, then stop the engine and use the key to lock all the equipment. Always take the key with you. Work equipment posture See → 12.16 "PARKING THE MACHINE."

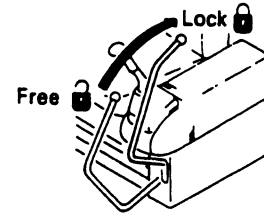

MOUNTING AND DISMOUNTING

- NEVER jump on or off the machine. NEVER get on or off a moving machine.
- When mounting or dismounting, always face the machine and use the handrails, machine or track frame steps, and track shoes.
- Do not hold any control levers when getting on or off the machine.
- Ensure safety by always maintaining at least three-point contact of hands and feet with the handrails, steps or track shoes.
- Always remove any oil or mud from the handrails, steps and track shoes. If they are damaged, repair them and tighten any loose bolts.
- If grasping the door handrail when mounting or dismounting or moving on the track, open and lock the door securely in the open position. Otherwise, the door may move suddenly, causing you to lose balance and fall.

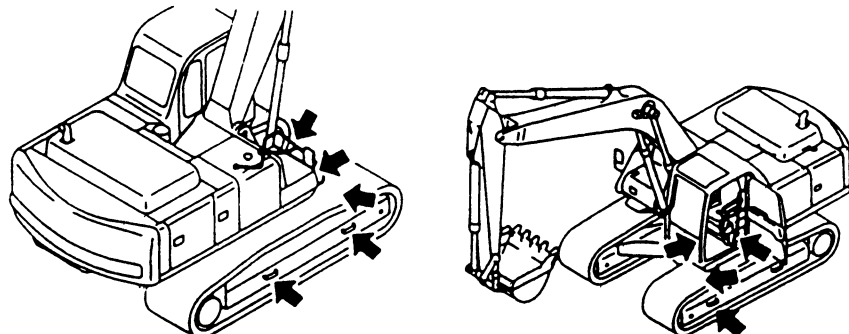

6. GENERAL PRECAUTIONS

FIRE PREVENTION FOR FUEL AND OIL

Fuel, oil, and antifreeze can be ignited by a flame. Fuel is particularly **FLAMMABLE** and can be **HAZARDOUS**.

- Keep flames away from flammable fluids.
- Stop the engine and do not smoke when refuelling.
- Tighten all fuel and oil caps securely.
- Refuelling and oiling should be carried out in well ventilated areas.
- Keep oil and fuel in a secure place and do not allow unauthorised persons to enter.

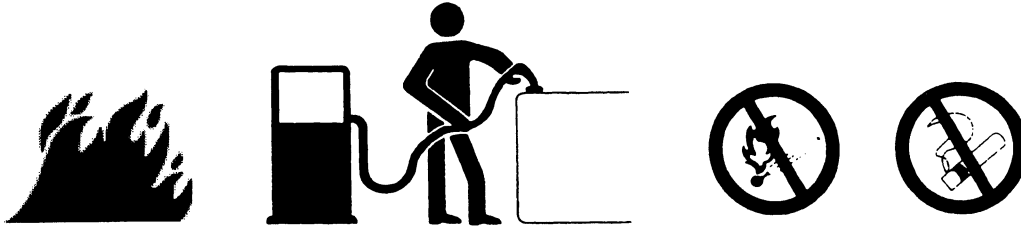

PRECAUTIONS WHEN HANDLING AT HIGH TEMPERATURES

- Immediately after operations are stopped, the engine coolant, engine oil, and hydraulic oil are at high temperatures, and are still under pressure. Attempting to remove the cap, drain the oil or water, or replace the filters may lead to serious burns. Always wait for the temperature to go down, and follow the specified procedures when carrying out these operations.
- To prevent hot water from spurting out:
 - 1) Turn engine off.
 - 2) Allow water to cool.
 - 3) Slowly loosen cap to relieve pressure before removing.
- To prevent hot oil from spurting out:
 - 1) Turn engine off.
 - 2) Allow oil to cool.
 - 3) Slowly loosen cap to relieve pressure before removing.



⚠ WARNING: Failure to follow these safety precautions may lead to a serious accident.

6. GENERAL PRECAUTIONS

ASBESTOS DUST HAZARD PREVENTION

Asbestos dust can be HAZARDOUS to your health if it is inhaled.

Your Komatsu machine and genuine Komatsu spare parts do not contain any asbestos. Use only genuine Komatsu spare parts. If spare parts containing asbestos are used, the following precautions must be observed:

- NEVER use compressed air for cleaning.
- Use water for cleaning to keep down the dust.
- Operate the machine with the wind to your back, whenever possible.
- Use an approved respirator if necessary.



CRUSHING OR CUTTING PREVENTION

- Do not enter, or put your hand or arm or any other part of your body between movable parts such as between the work equipment and cylinders, or between the machine and work equipment. If the work equipment is operated, the clearance will change and this may lead to serious damage or personal injury.



FIRE EXTINGUISHER AND FIRST AID KIT

- Know how to use fire extinguisher (if installed).
- Provide a first aid kit at the storage point.
- Know what to do in the event of a fire.
- Be sure you know the phone numbers of persons you should contact in case of an emergency.

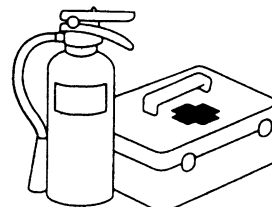

6. GENERAL PRECAUTIONS

PROTECTION AGAINST FALLING OR FLYING OBJECTS

If there is any danger of falling or flying objects hitting the operator, install protective guards in place to protect the operator as required for each particular situation.

- For work with breakers, install a front guard on the windshield. Also, place a laminate coating sheet over the windshield.
- For demolition or shear work, install a front guard on the windshield and a top guard on the cab. Also, place a laminate coating sheet over the windshield.
- For work in mines, quarries, demolition, tunnels or other places where there is danger of falling rocks, put FOPS (falling object protective structure) in place. Also, place a laminate coating sheet over the windshield.

The above comments are made with regards to typical working conditions. By all means you should put on other guards if required by conditions at your particular site.

For details of safety guards, please contact your Komatsu distributor.

Also, even for other types of work, if there is any danger of being hit by falling or flying objects or of objects entering the operator's cab, select and install a guard that matches the working conditions.

Be sure to close the front window before commencing work.

When carrying out the above operations, make sure to keep all persons other than the operator outside the range of falling or flying objects. Be particularly sure to maintain a proper distance when carrying out shear operations.

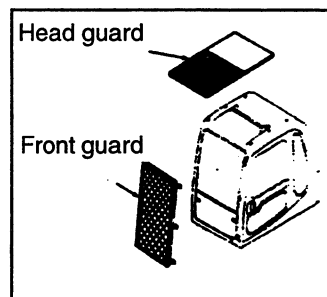
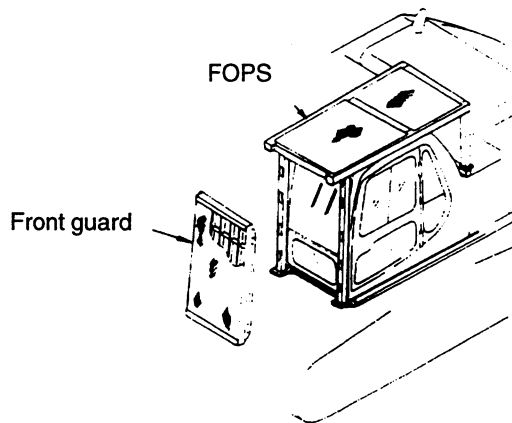
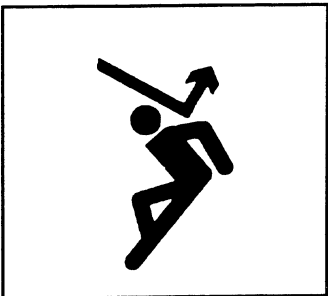
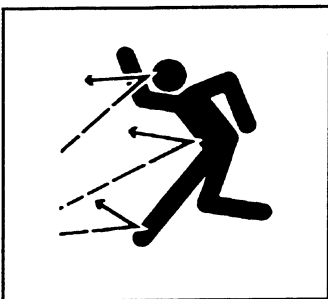

⚠ WARNING: Failure to follow these safety precautions may lead to a serious accident.

PRECAUTIONS FOR ATTACHMENTS

- When installing and using an optional attachment, read the instruction manual for the attachment and the information related to attachments in this manual.
- Do not use attachments that are not authorised by Komatsu or your Komatsu distributor. Use of unauthorised attachments could create a safety problem and adversely affect the proper operation and useful life of the machine.
- Any injuries, accidents, product failures resulting from the use of unauthorised attachments will not be the responsibility of Komatsu.

MACHINES WITH ACCUMULATOR

On machines equipped with an accumulator, for a short time after the engine is stopped, the work equipment will lower under its own weight when the work equipment control lever is shifted to LOWER. After the engine is stopped, set the safety lock lever to the lock position (and also lock the attachment pedal with the lock pin).

When releasing the pressure inside the work equipment circuit on machines equipped with an accumulator, follow the procedure given in the inspection and maintenance section.

Method of releasing pressure → See 11.18 “HANDLING THE ACCUMULATOR”.

The accumulator is filled with high-pressure nitrogen gas, and it is extremely dangerous if it is handled in the wrong way. Always observe the following precautions.

- Never make any hole in the accumulator or expose it to flame or fire.
- Do not weld anything to the accumulator.
- When carrying out disassembly or maintenance of the accumulator, or when disposing of the accumulator, it is necessary to release the gas from the accumulator. A special air bleed valve is necessary for this operation, so please contact your Komatsu distributor.

Gas in accumulator → See 11.18 “HANDLING THE ACCUMULATOR”.

EMERGENCY EXIT

- When exit by normal means is prevented in an emergency you can get out through the emergency exit (rear window).
- Pull the ring at the bottom of the window and remove strip. This will allow you to push out glass.

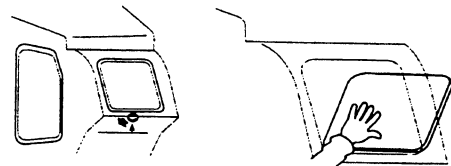

ROTATING BEACON (OPTION)

- When the machine is operated on or beside a road, a rotating beacon is required to avoid a traffic accident.
- Contact your Komatsu distributor to install beacon lamp.

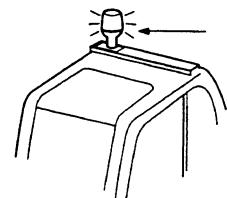

ELECTROMAGNETIC INTERFERENCE

When this machine is operating close to a source of high electromagnetic interference, such as a radar station, some abnormal phenomena may be observed.

- The display on the monitor panel may behave erratically.
- The warning buzzer may sound.

These effects do not signify a malfunction and the machine will return to normal as soon as the source of interference is removed.

7. PRECAUTIONS DURING OPERATION

7.1 BEFORE STARTING ENGINE

SAFETY AT WORKSITE

- Before starting the engine, thoroughly check the area for any unusual conditions that could be dangerous.
- Before starting the engine, examine the terrain and soil conditions of the worksite. Determine the best and safest method of operation.
- Make the slope as horizontal as possible before continuing operations.
- If you need to operate on a street, protect pedestrians and cars by designating a person for worksite traffic duty or by installing fences around the worksite.
- If water lines, gas lines, and high-voltage electrical lines may be buried under the worksite, contact each utility and identify their locations. Be careful not to sever or cut any of these lines.
- Check the depth and flow of water before operating in water or crossing a river. NEVER be in water which is in excess of the permissible water depth.
Permissible water depth
See → 12.11 “PRECAUTIONS FOR OPERATION.”

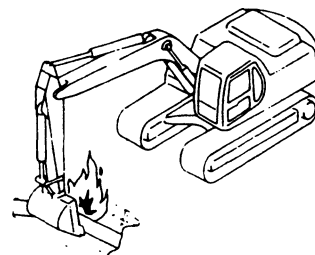

FIRE PREVENTION

- Thoroughly remove wood chips, leaves, paper and other flammable things accumulated on the engine compartment. They could cause a fire.
- Check fuel, lubrication, and hydraulic systems for leaks. Have any leaks repaired. Wipe up any excess oil, fuel or other flammable fluids.
Check point → See 12.1.1 “WALK-AROUND CHECK.”
- Be sure a fire extinguisher is present and working.



IN OPERATOR'S CAB

- Do not leave tools or spare parts lying around in the operator's compartment. They may damage or break the control levers or switches. Always put them in the tool box on the left side of the machine.
- Keep the cab floor, controls, steps and handrails free of oil, grease, snow, and excess dirt.

⚠ WARNING: Failure to follow these safety precautions may lead to a serious accident.

7. PRECAUTIONS DURING OPERATION

VENTILATION FOR ENCLOSED AREAS

- If it is necessary to start the engine within an enclosed area, provide adequate ventilation. Exhaust fumes from the engine can KILL.



PRECAUTIONS FOR MIRRORS, WINDOWS AND LIGHTS

- Remove all dirt from the surface of the windows and lights to ensure that you can see well.
- Adjust the rear view mirror so that you can see clearly from the operator's seat, and always keep the surface of the mirror clean. If any glass is broken, replace it with a new part.
- Check that the head lamps and working lamps are installed to match the operating conditions. Check also that they light up properly.

7. PRECAUTIONS DURING OPERATION

7.2 OPERATING MACHINE

WHEN STARTING THE ENGINE

- Walk around for machine again just before mounting it, to check for people and objects that might be in the way.
- NEVER start the engine if a warning tag has been attached to the wrist control.
- Before starting the engine, sound the horn as an alert.
- Start and operate the machine only while seated.
- Do not allow anyone other than the operator to ride in the cab or on the machine body.
- For machines equipped with a travel alarm buzzer, check that the warning device operates correctly.

CHECK DIRECTION BEFORE STARTING MACHINE

Before operating the travel lever, check the direction of the track frame. If the sprocket is at the front, the travel lever must be operated in the opposite direction.

Travel operations → See 12.4 “TO MOVE THE MACHINE OFF.”

Travel in reverse direction

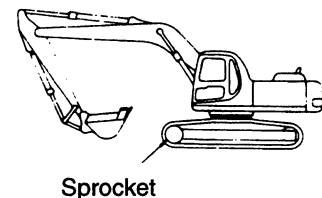

CHECK THAT NO ONE IS IN THE AREA BEFORE SWINGING OR TRAVELLING IN REVERSE

- Always position a signalman when operating in dangerous places or places where the view is not clear.
- Make sure that no one comes inside the swing radius or direction of travel.
- Before starting to move, sound the horn or give a signal to warn people not to come close to the machine.
- There are blind spots behind the machine, so if necessary, swing the upper structure to check that there is no one behind the machine before travelling in reverse.

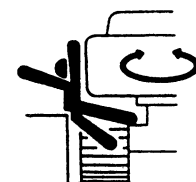

WARNING: Failure to follow these safety precautions may lead to a serious accident.

7. PRECAUTIONS DURING OPERATION

PRECAUTIONS WHEN TRAVELLING

- Fold in the work equipment as shown in the diagram below, and keep it at a height of 40-50 cm (16 to 20 in) from the ground level before starting to travel.
- When travelling, do not operate the work equipment control levers. If the work equipment control levers have to be operated, never operate them suddenly.
- When travelling on rough ground, travel at low speed, and avoid sudden changes in direction.
- Avoid travelling over obstacles as far as possible. If the machine has to travel over an obstacle, keep the work equipment as close to the ground as possible and travel at low speed. Never travel over obstacles which make the machine tilt strongly (10° or more).

Travel posture

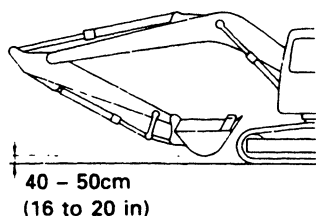

INCORRECT

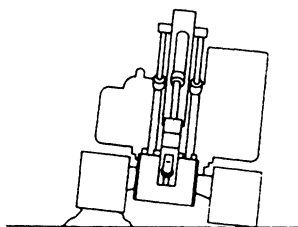

TRAVELLING ON SLOPES

- Travelling on hills, banks or slopes that are steep could result in the machine tipping over or slipping.
- On hills, banks or slopes, carry the bucket closer to the ground, approximately 20 to 30 cm (8 to 12 in) above the ground. In case of emergency, quickly lower the bucket to the ground to help the machine stop and prevent it from tipping over.
- Do not turn on slopes or travel across slopes. Always go down to a flat place to perform these operations.
Method of travelling on slopes → See 12.12 “PRECAUTIONS WHEN TRAVELLING UP OR DOWN HILLS.”
- Do not travel up and down on grass, fallen leaves, and wet steel plates. These materials may allow the machine to slip, if it is travelling sideways. Keep travel speed very low.

Downhill

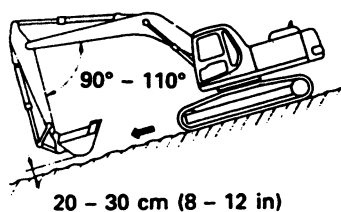

Uphill

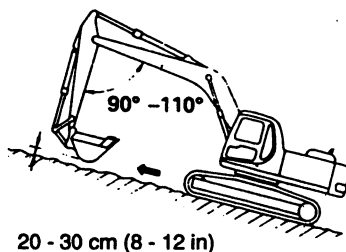

INCORRECT

CORRECT

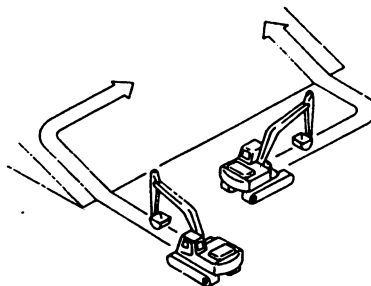

7. PRECAUTIONS DURING OPERATION

PROHIBITED OPERATIONS

- Do not dig the work face under an overhang. This may cause the overhang to collapse and fall on top of the machine.
- Do not carry out deep digging under the front of the machine. The ground under the machine may collapse and cause the machine to fall.

INCORRECT

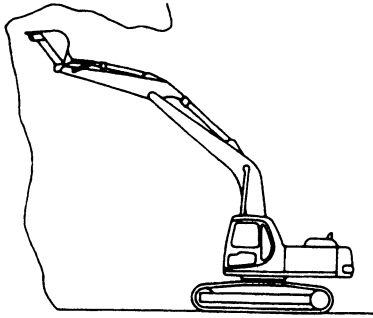

INCORRECT

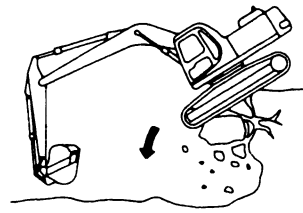

DO NOT GO CLOSE TO HIGH-VOLTAGE CABLES

- Going close to high-voltage cables can cause electric shock. Always maintain the safe distance given below between the machine and the electric cable.
- The following actions are effective in preventing accidents.
 - 1) Wear shoes with rubber or leather soles.
 - 2) Use a signalman to give warning if the machine approaches too close to the electric cable.
- If the work equipment should touch the electric cable, the operator should not leave the operator's compartment.
- When carrying out operations near high voltage cables, do not let anyone come close to the machine.
- Check with the electricity company about the voltage of the cables before starting operations.

Voltage	Min. safety distance	
6.6 kV	3 m	10 ft
33.0 kV	4 m	14 ft
66.0 kV	5 m	17 ft
154.0 kV	8 m	27 ft
275.0 kV	10 m	33 ft

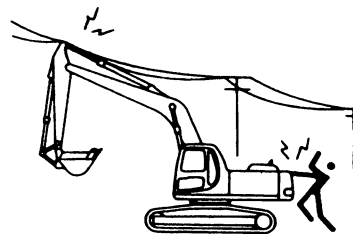

 **WARNING:** Failure to follow these safety precautions may lead to a serious accident.

DO NOT HIT WORK EQUIPMENT

- When working in places where there are height limits, such as in tunnels, under bridges, under electric cables, or in garages, be extremely careful not to hit the boom or arm.

ENSURE GOOD VISIBILITY

- When working in dark places, install working lamps and head lamps, and set up lighting in the work area if necessary.
- Stop operations if the visibility is poor, such as in mist, snow, or rain, and wait for the weather to improve to a condition that allows the operation to be carried out safely.

OPERATE CAREFULLY ON SNOW

- When working on snow or icy roads, even a slight slope may cause the machine to slip to the side, so always travel at low speed and avoid sudden starting, stopping, or turning.
- When there has been heavy snow, the road shoulder and objects placed beside the road are buried in the snow and cannot be seen, so always carry out snow-clearing operations carefully.

WORKING ON LOOSE GROUND

- Avoid operating your machine too close to the edge of cliffs, overhangs, and deep ditches. If these areas collapse, your machine could fall or tip over and result in serious injury or death. Remember that the soil after heavy rain or blasting is weakened in these areas.
- Earth laid on the ground and the soil near ditches are loose. They can collapse under the weight or vibration of your machine.
- Install the HEAD GUARD (FOPS) if working in areas where there is danger of falling rocks and dirt.

7. PRECAUTIONS DURING OPERATION

OPERATIONS ON SLOPES

- When working on slopes, there is danger that the machine may lose its balance and turn over when the swing or work equipment are operated. Always carry out these operations carefully.
- Do not swing the work equipment from the uphill side to the downhill side when the bucket is loaded. This operation is dangerous.
(See the upper diagram on the right.)
- If the machine has to be used on a slope, pile the soil to make a platform that will keep the machine as horizontal as possible.
(See the lower diagram on the right.)
Piled soil on slope → See 12.12 “PRECAUTIONS WHEN TRAVELLING UP OR DOWN HILLS.”

INCORRECT

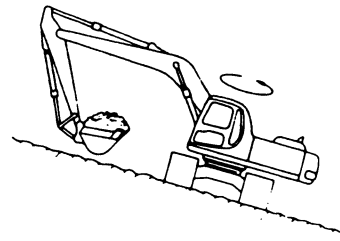

CORRECT

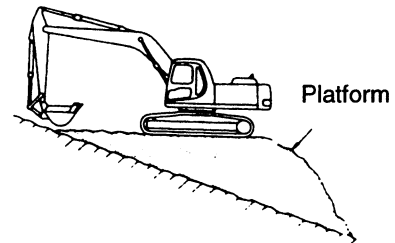

PARKING THE MACHINE

- Park on level ground whenever possible. If not possible, block the tracks, lower the bucket to the ground and thrust the bucket in the ground.

CORRECT

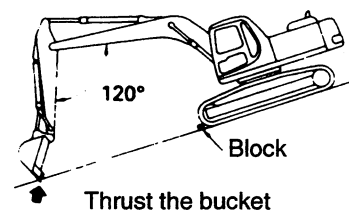

- When parking on public roads, provide fences and signs, such as flags or lights, on the machine to warn passersby to be careful. Be sure that the machine, flags or lights do not obstruct traffic.
Parking procedure → See 12.16 “PARKING THE MACHINE.”

- When leaving the machine, lower the work equipment completely to the ground, set the safety lock lever to the LOCK position, then stop the engine and use the key to lock all the equipment. Always take the key with you.

Work equipment posture → See 12.16 “PARKING THE MACHINE”.

Places to lock → See 12.20 “LOCKING”.

Method of locking

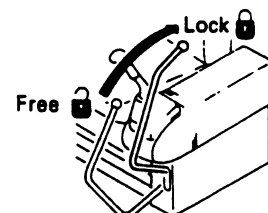

7.3 TRANSPORTATION

LOADING AND UNLOADING

- Loading and unloading the machine always involves potential hazards. **EXTREME CAUTION SHOULD BE USED.**
When loading or unloading the machine, run the engine at low idling and travel at low speed.
- Perform loading and unloading on firm, level ground only. Maintain a safe distance from the edge of a road.
- **ALWAYS** block the wheels of the hauling vehicle and place blocks under both ramps before loading and unloading.
- **ALWAYS** use ramps of adequate strength. Be sure the ramps are wide and long enough to provide a safe loading slope.
- Be sure that the ramps are securely positioned and fastened, and that the two sides are at the same level as one another.
- Be sure the ramp surface is clean and free of grease, oil, ice and loose materials. Remove dirt from the machine tracks.
- **NEVER** correct your steering on the ramps. If necessary, drive away from the ramps and climb again.
- Swing the upper structure with extreme care on the trailer to avoid a possible accident caused by body instability.
- After loading, block the machine tracks and secure the machine with tie-downs.

Loading and unloading See → 13 "TRANSPORTATION"
Tie-downs See → 13 "TRANSPORTATION"

CORRECT

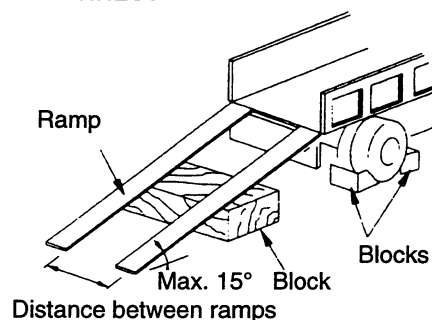

SHIPPING

- When shipping the machine on a hauling vehicle, obey all state and local laws governing the weight, width, and length of a load. Also obey all applicable traffic regulations.
- Determine the shipping route while taking into account the width, height and weight of the load.

7. PRECAUTIONS DURING OPERATION

7.4 BATTERY

BATTERY HAZARD PREVENTION

- Battery electrolyte contains sulphuric acid and can quickly burn the skin and eat holes in clothing. If you spill acid on yourself, immediately flush the area with water.
- Battery acid could cause blindness if splashed into the eyes. If acid gets into the eyes, flush them immediately with large quantities of water and see a doctor at once.
- If you accidentally drink acid, drink a large quantity of water or milk, beaten egg or vegetable oil. Call a doctor or poison prevention centre immediately.
- When working with batteries. **ALWAYS** wear safety glasses or goggles.
- Batteries generate hydrogen gas. Hydrogen gas is very **EXPLOSIVE**, and is easily ignited with a small spark or flame.
- Before working with batteries, stop the engine and turn the starting switch to the OFF position.
- Avoid short-circuiting the battery terminals through accidental contact with metallic objects, such as tools, across the terminals.
- When removing or installing, check which is the positive (+) terminal and negative (-) terminal.
- Tighten the battery cap securely.
- Tighten the battery terminals securely. Loosened terminals can generate sparks and lead to an explosion.
- When removing battery cap wear rubber groves to prevent electrolyte contact with skin.

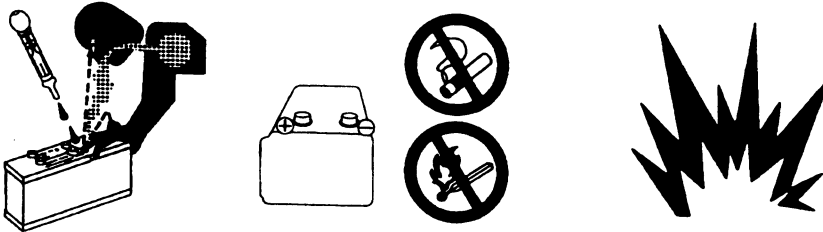

STARTING WITH BOOSTER CABLES

- **ALWAYS** wear safety glasses or goggles when starting the machine with booster cables.
- When starting from another machine, do not allow the two machines to touch.
- Be sure to connect the positive (+) cable first when installing the booster cables. Disconnect the ground or negative (-) cable first when removing them.
- If any tool touches between the positive (+) terminal and the chassis, it will cause sparks. This is dangerous, so be sure to work carefully.
- Connect the batteries in parallel: positive to positive and negative to negative.
- When connecting the ground cable to the frame of the machine to be started, be sure to connect it as far as possible from the battery.

Starting with booster cables → See 16.5 "IF BATTERY IS DISCHARGED."

INCORRECT

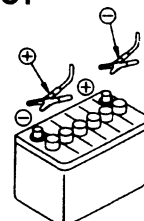

7.5 TOWING

WHEN TOWING, ATTACH WIRE TO FRAME

- Injury or death could result if a disabled machine is towed incorrectly.
- If your machine is towed by another machine, ALWAYS use a wire rope with a sufficient towing capacity.
- NEVER allow a disabled machine to be towed on a slope.
- Do not use a chinked or frayed wire rope.
- Do not straddle the towing cable or wire rope.
- When connecting up a towing machine, do not let anyone enter the area between the towing machine and the equipment being towed.
- Set the towing machine and the towing connection of the equipment being towed in a straight line when connecting it.
- Place pieces of wood between the wire ropes and body to protect them from wear or damage.
- Never tow the machine using the light-duty towing hole.

Towing method → See 16.2 “METHOD OF TOWING MACHINE.”

CORRECT

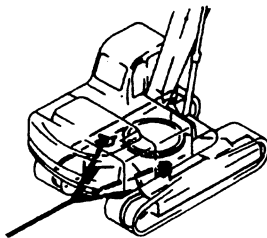

F 19584

INCORRECT

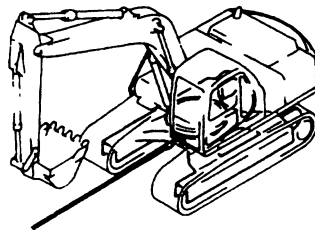

F 19585

7. PRECAUTIONS DURING OPERATION

7.6 BUCKET WITH HOOK

7.6.1 GENERAL PRECAUTIONS

SPECIAL HOOK

- When carrying out lifting work, the special lifting hook is necessary.
- The following operations are prohibited.
 - Lifting loads with a wire rope fitted around the bucket teeth.
 - Lifting loads with the wire rope wrapped directly around the boom or arm.

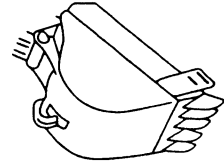

CHECKING HOOK

- When lifting a load, carry out the following checks to confirm that there is no abnormality before starting operations.
 - Check that there are no cracks or deformation in the lifting equipment.
 - Check that there is no abnormality in the stopper device.

HOOKING WIRE ROPE SECURELY TO HOOK

- When performing lifting operation, securely hook the wire rope onto the special lifting hook.

PRECAUTIONS FOR MACHINE INSTALLATION

- After carrying out a preliminary inspection of ground conditions, select a flat, solid location. Confirm that the machine can be safely operated without toppling or rolling.

PROHIBITED OPERATIONS OTHER THAN MAIN APPLICATIONS

- When performing lifting operation, never raise or lower a person.

NO PERSONS SHALL BE PERMITTED TO ENTER THE WORKING AREA

- Due to the possible danger of the load falling or of collision with the load, no persons shall be allowed in the working area.

 **WARNING:** Failure to follow these safety precautions may lead to a serious accident.

7. PRECAUTIONS DURING OPERATION

OPERATION SUPERVISOR

- Before performing lifting operation, designate an operation supervisor. Always execute operation according to his instructions.
 - Execute operating methods and procedures under his direction.
 - Select a person responsible for signalling. Operate only on signals given by such person.

HANDLING OF WIRE ROPES ETC.

- Wear leather gloves when handling wire ropes.

HANDLING OF FLUIDS

- Some oils and other fluids, such as Antifreeze, can be harmful to you and the environment, you should therefore always follow the manufacturers instructions regarding storage, handling and disposal.

HANDLING OF USED ENGINE OILS

- Avoid contact with used engine oils.
- Refer to engine oils data sheet for handling and storage precautions.

HANDLING OF OILS

- For diesel oils, hydraulic oils and oils used in the swing machinery, PTO, transmission axles and hubs avoid prolonged or frequent contact with skin.
- Refer to manufacturers data sheet for handling and storage precautions.

HANDLING OF FLUIDS

- For antifreeze and grease refer to manufacturers data sheet for handling and storage precautions.

PROTECTING EYES

- Some oils and fluids can damage eyes. Refer to manufactured data sheet for handling and storage instructions.

7. PRECAUTIONS DURING OPERATION

7.6.2 PRECAUTIONS FOR LIFTING OPERATION

GRADUAL LIFTING OPERATION

- When carrying out lifting operations, run the engine at low idling and use the L.O. (lifting operation mode).
- Avoid sudden lever shifting and acceleration.
- Swing speed is three to four times that of movable cranes. Therefore, be especially careful when performing swing operation.

NEVER LEAVE THE OPERATOR'S SEAT

- Never leave the operator's seat while lifting a load.

NEVER CARRY OUT EXCESSIVE OPERATIONS

- Operation exceeding machine performance may result in accident or failure.
- Carry out lifting operation within specified load limit.
- Never carry out operations which may damage the machine such as overload or over-impact-load.
- Never drag a load laterally or longitudinally, nor retract the arm, otherwise, a dangerous situation may result.

INCORRECT

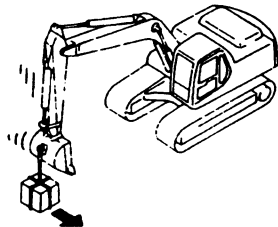

INCORRECT

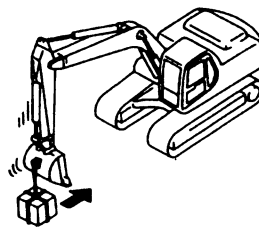

NEVER TRAVELLING WHILE LIFTING A LOAD

- Never travel while carrying a load.

OPERATING POSTURE

- If the machine posture is not correct, the wire ropes or ring may detach from the hook. Confirm that the hook angle is correct to avoid this.

8. PRECAUTIONS FOR MAINTENANCE

8.1 BEFORE CARRYING OUT MAINTENANCE

WARNING TAG

- If others start the engine or operate the controls while you are performing service or lubrication, you could suffer serious injury or death.
- ALWAYS attach the WARNING TAG to the control lever in the operator's cab to alert others that you are working on the machine. Attach additional warning tags around the machine, if necessary.
- These tags are available from your Komatsu distributor. (Part no. 20E-00-K1340)

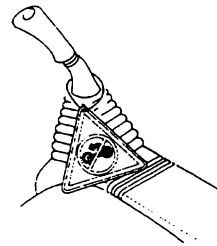
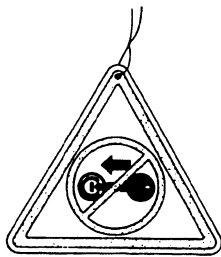

PROPER TOOLS

- Use only tools suited to the task. Using damaged, low quality, faulty, or makeshift tools could cause personal injury.

Tools → See 21.1 "INTRODUCTION OF NECESSARY TOOLS".



PERIODIC REPLACEMENT OF SAFETY CRITICAL PARTS

- Replace the following fire-related components periodically:
 - Fuel system: Fuel hose, spilling hose, and fuel tube cap
 - Hydraulic system: Pump outlet hose, and front and rear pump branch hoses
- Replace these components periodically with new ones, regardless of whether or not they appear to be defective. These components deteriorate over time.
- Replace or repair any such components if any defect is found, even though they have not reached the time specified. Replacement of safety critical components
→ See 22 "PERIODIC REPLACEMENT OF SAFETY CRITICAL PARTS".

8. PRECAUTIONS FOR OPERATION

STOP THE ENGINE BEFORE CARRYING OUT INSPECTION AND MAINTENANCE

- Always stop the machine on firm flat ground and stop the engine before carrying out inspection and maintenance.
- If it is necessary to run the engine when carrying out maintenance, such as when cleaning the inside of the radiator, place the safety lock lever at the LOCK position and carry out the operation with two workers.
- One worker should sit in the operator's seat so that he can stop the engine immediately if necessary. He should also be extremely careful not to touch any lever by mistake. Touch the levers only when they have to be operated.
- The worker carrying out the maintenance should be extremely careful not to touch or get caught in the moving parts.

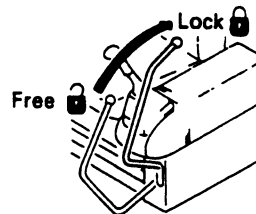
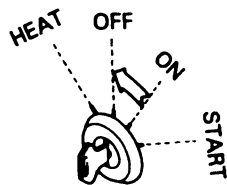

RULES TO FOLLOW WHEN ADDING FUEL OR OIL

- Spilt fuel and oil may cause you to slip, so always wipe it up immediately.
- Always tighten the cap of the fuel and oil fillers securely.
- Never use fuel for washing any parts.
- Always add fuel and oil in a well-ventilated place.



⚠ Failure to follow these safety precautions may lead to a serious accident.

RADIATOR WATER LEVEL

- If it is necessary to add water to the radiator, stop the engine and allow the engine and radiator to cool down before adding the water.
- Slowly loosen the caps to relieve pressure before removing the caps.

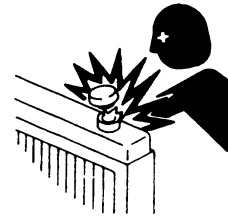

USE OF LIGHTING

- When checking fuel, oil, coolant, or battery electrolyte, always use lighting with anti-explosion specifications. If such lighting equipment is not used, there is danger of explosion.



8. PRECAUTIONS FOR MAINTENANCE

8.2 DURING MAINTENANCE

PERSONNEL

- Only authorised personnel can service and repair the machine. Extra precaution should be used when grinding, welding, and using a sledge-hammer.

ATTACHMENTS

- Place attachments that have been removed from the machine in a safe place so that they do not fall. If they fall on you or others, serious injury could result.



WORK UNDER THE MACHINE

- Always lower all movable work equipment to the ground or to their lowest position before performing service or repairs under the machine.
- Always block the track shoes of the machine securely.
- Never work under the machine if the machine is poorly supported.



KEEP THE MACHINE CLEAN

- Spilt oil or grease, or scattered tools or broken pieces are dangerous because they may cause you to slip or trip.
Always keep your machine clean and tidy.
- If water gets into the electrical system, there is danger that the machine may not move or may move unexpectedly.
Do not use water or steam to clean the sensors, connectors, or the inside of the operator's compartment.



WARNING: For reasons of safety, always follow these safety precautions.

8. PRECAUTIONS FOR OPERATION

PRECAUTIONS WITH BATTERY

- When repairing the electrical system or when carrying out electrical welding, remove the negative (-) terminal of the battery to stop the flow of current.



HANDLING HIGH-PRESSURE HOSES

- Do not bend high-pressure hoses or hit them with hard objects. Do not use any bent or cracked piping, tubes or hoses. They may burst during use.
- Always repair any loose or broken fuel hoses or oil hoses. If fuel or oil leaks, it may cause a fire.

PRECAUTIONS WITH HIGH PRESSURE OIL

- Do not forget that the work equipment circuits are always under pressure.
- Do not add oil, drain oil, or carry out maintenance or inspection before completely releasing the internal pressure.
- If oil is leaking under high pressure from small holes, it is dangerous if the jet of high-pressure oil hits your skin or enters your eyes. Always wear safety glasses and thick gloves, and use a piece of cardboard or a sheet of wood to check for oil leakage.
- If you are hit by a jet of high-pressure oil, consult a doctor immediately for medical attention.

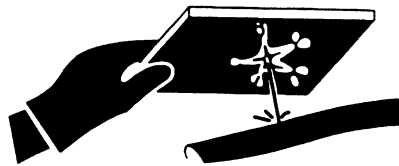

8. PRECAUTIONS FOR MAINTENANCE

PRECAUTIONS WHEN CARRYING OUT MAINTENANCE AT HIGH TEMPERATURE OR HIGH PRESSURE

- Immediately after stopping operations, the engine cooling water and oil at all parts is at high temperature and under high pressure.

In this condition, if the cap is removed, or the oil or water are drained, or the filters are replaced, this may result in burns or other injury. Wait for the temperature to go down, then carry out the inspection and maintenance in accordance with the procedures given in this manual.

Cleaning inside or cooling system → see 24.1 “WHEN REQUIRED.”

Checking cooling water level, hydraulic oil level → see 24.2 “CHECK BEFORE STARTING.”

Checking lubricating oil level, adding oil → see 24.5, 24.6, 24.7, 24.8, 24.9 “PERIODIC MAINTENANCE.”

Changing oil, replacing filters → see 24.5, 24.6, 24.7, 24.8, 24.9 “PERIODIC MAINTENANCE.”

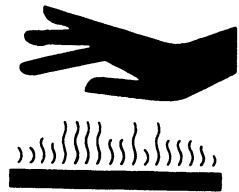

PRECAUTIONS WHEN USING HIGH PRESSURE GREASE TO ADJUST TRACK TENSION

Grease is pumped into the track tension adjustment system under high pressure. If the specified procedure for maintenance is not followed when making adjustments, the plug or grease fitting may fly out and cause damage or personal injury.

- When loosening the grease drain plug, never loosen it more than one turn.
- Never put your face, hands, feet, or any other part of your body directly in front of any grease drain plug or valve.

Adjusting track tension → see 24.1 “WHEN REQUIRED.”



ROTATING FAN AND BELT

- Keep away from rotating parts and be careful not to let anything get caught in them.
- If your body or tools touch the fan blades or fan belt, they may be cut off or sent flying, so never touch any rotating parts.

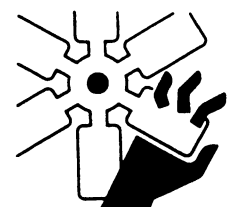

⚠ **WARNING:** For reasons of safety,
always follow these safety precautions.

WASTE MATERIALS

- Never dump waste oil in a sewer system, rivers, etc.
- Always put oil drained from your machine in containers. Never drain oil directly on the ground.
- Obey appropriate laws and regulations when disposing of harmful objects such as oil, fuel, coolant, solvent, filters, batteries, and others.

INCORRECT

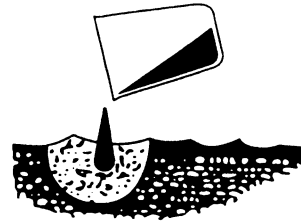

9. POSITION FOR ATTACHING SAFETY LABELS

Always keep these labels clean. If they are lost or damaged, attach them again or replace them with a new label.

There are other labels in addition to the safety labels listed as follows, so handle them in the same way. Safety labels are available from your Komatsu distributor.

POSITION FOR ATTACHING SAFETY LABELS

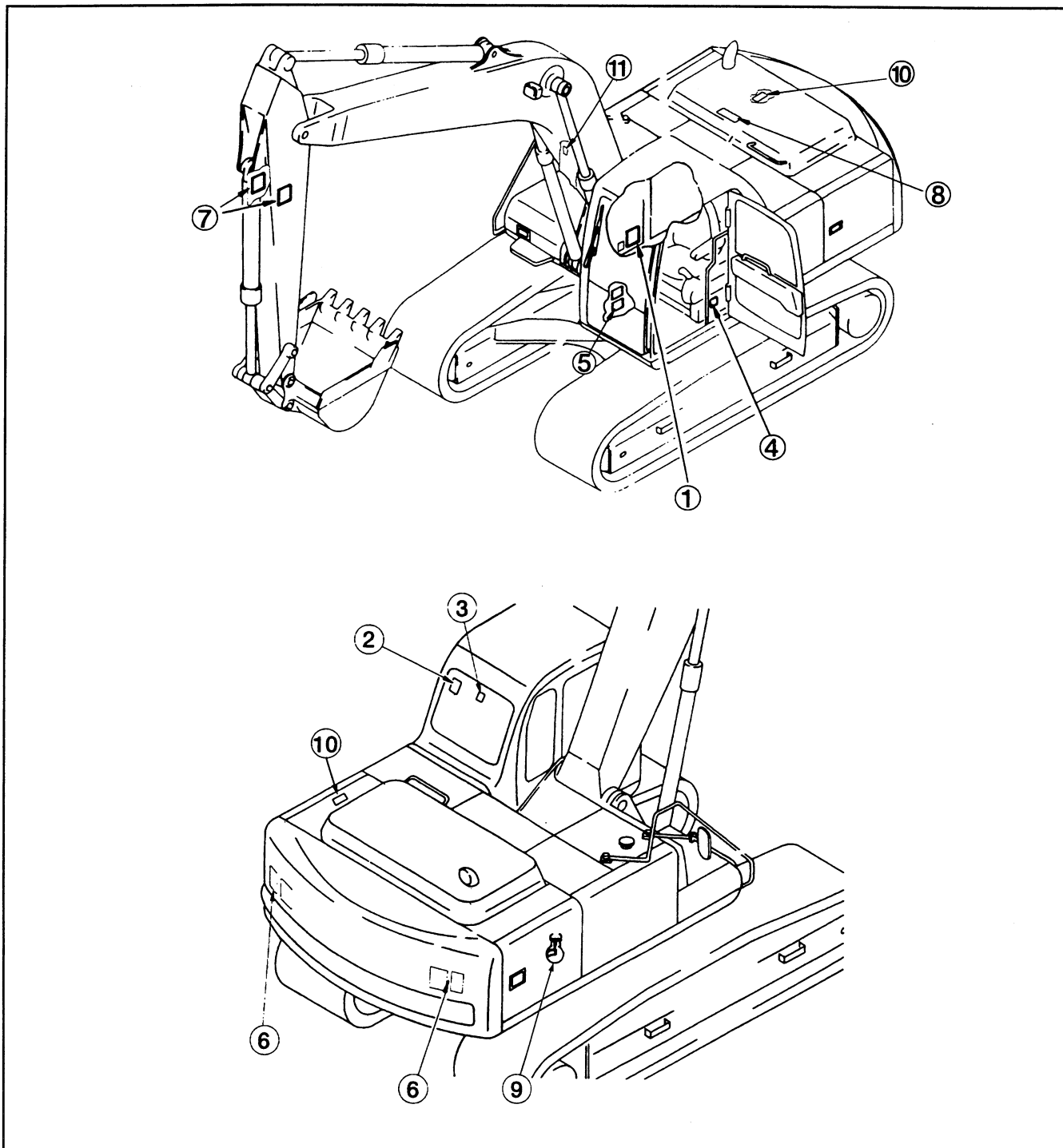

1. Warnings for operation, inspection and maintenance

1. 2OE-00-K1170

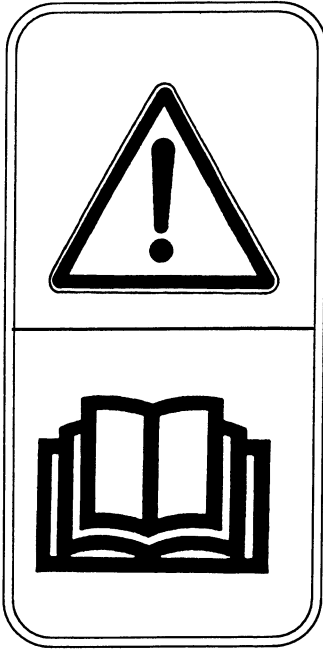

- Improper operation and maintenance can cause serious injury or death.
- Read the manual and labels before operation and maintenance. Follow instructions and warnings in manual and in labels on machine.
- Keep the manual in machine cab near operator. If this manual is lost, please contact your Komatsu distributor for a replacement.



- Always apply lock when leaving operator's seat.

2. 2OE-00-KI230

Warnings when opening front window

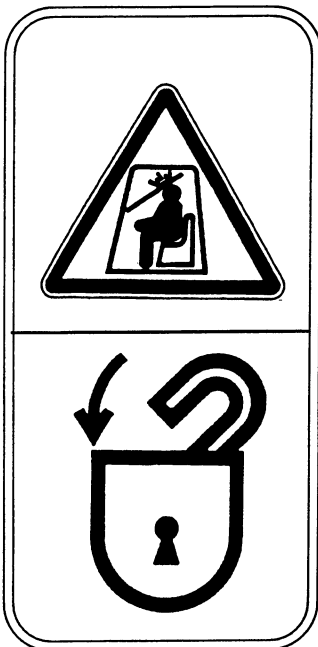

- When raising window, lock it in place with lock pins on both sides.
- Falling window can cause injury.

3. 20Y-00-K2220

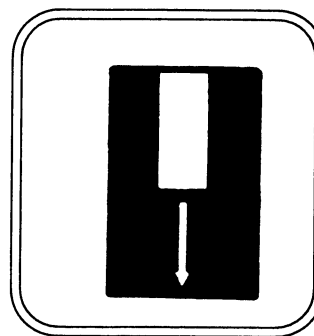

- Emergency exit
- Read operation manual before operation

4. 2OE-00-K1130

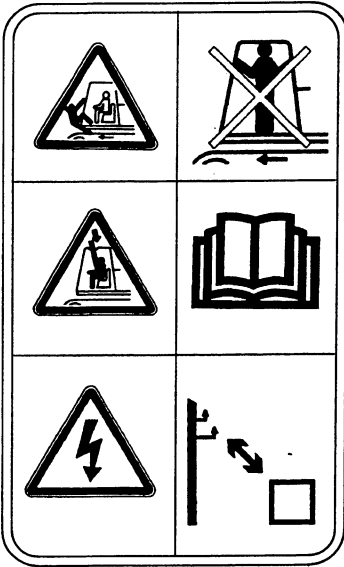

WARNING - No passengers
No passengers allowed to ride on machine while it is moving

WARNING - DANGER OF FALLING OBJECTS
Do not operate where a danger of falling objects exists.
Consult your dealer for fitting of FOPS protection.

HAZARDOUS - Voltage hazard
Serious injury or death can occur if machine or attachments are not kept safe distance away from electric lines.

6. 2OE-00-K1150



Keeping out of moving area

To prevent SEVERE INJURY or DEATH do the following before moving machine or its attachments:

- Sound horn to alert people nearby.
- Be sure no one is on or near machine or in the swing area.
- Rotate cab for full view of travel path if it can be done safely.
- Use spotter if view is obstructed.

Always follow the above.

5. 2OE-00-K1280

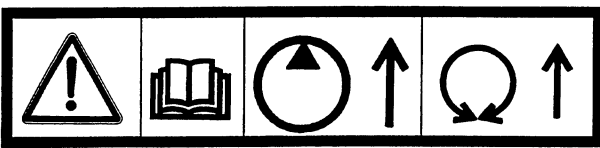

Pump control override switch and swing lock override switch
Read operation manual before operation

7. 2OE-00-K1140



⚠ WARNING: Failure to follow these safety precautions may lead to a serious accident.

8. 2OE-00-K1310

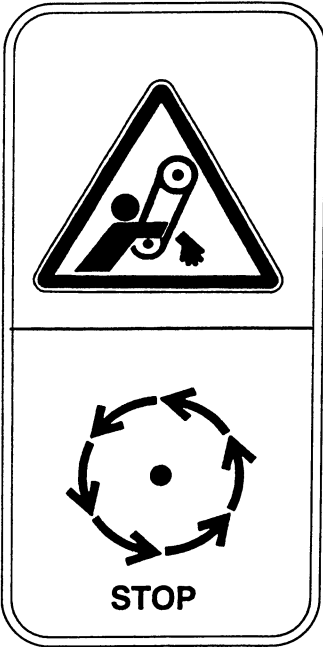

- Do not open cover while engine is running.

10. 2OE-00-K1190

Warning for high temperature coolant and oil

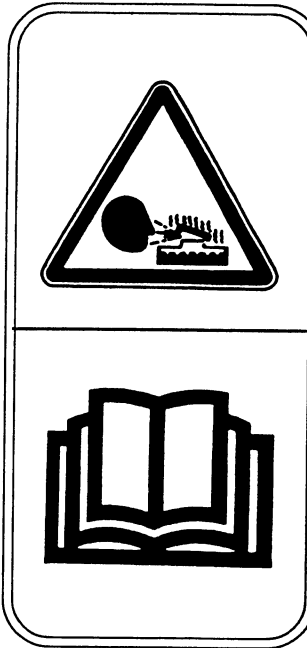

Hot water and oil hazard

To prevent hot water and oil from spurting out:

- Turn engine off.
- Allow water to cool.
- Slowly loosen cap to relieve pressure before removing.
- Read operation manual before operation.

9. 2OE-00-K1210

Warnings for handling the accumulator

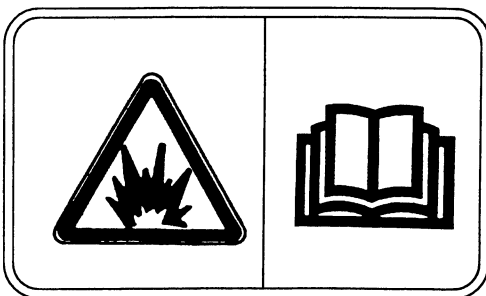

Explosion hazard

- Keep away from flame.
- Do not weld or drill.
- Read operation manual before operation.

11. 2OE-00-K1110

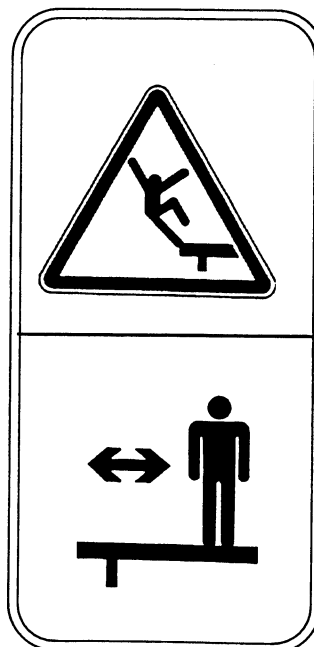

- Warning for falling from upper-structure.
- Keep away from sides of machine.
- Keep of counter-weight.
- Do not ride on machine when it is moving

OPERATION

10. GENERAL VIEW

10.1 GENERAL VIEW OF MACHINE

If directions are indicated in this section, the refer to the directions shown by in the arrows in the diagram below.

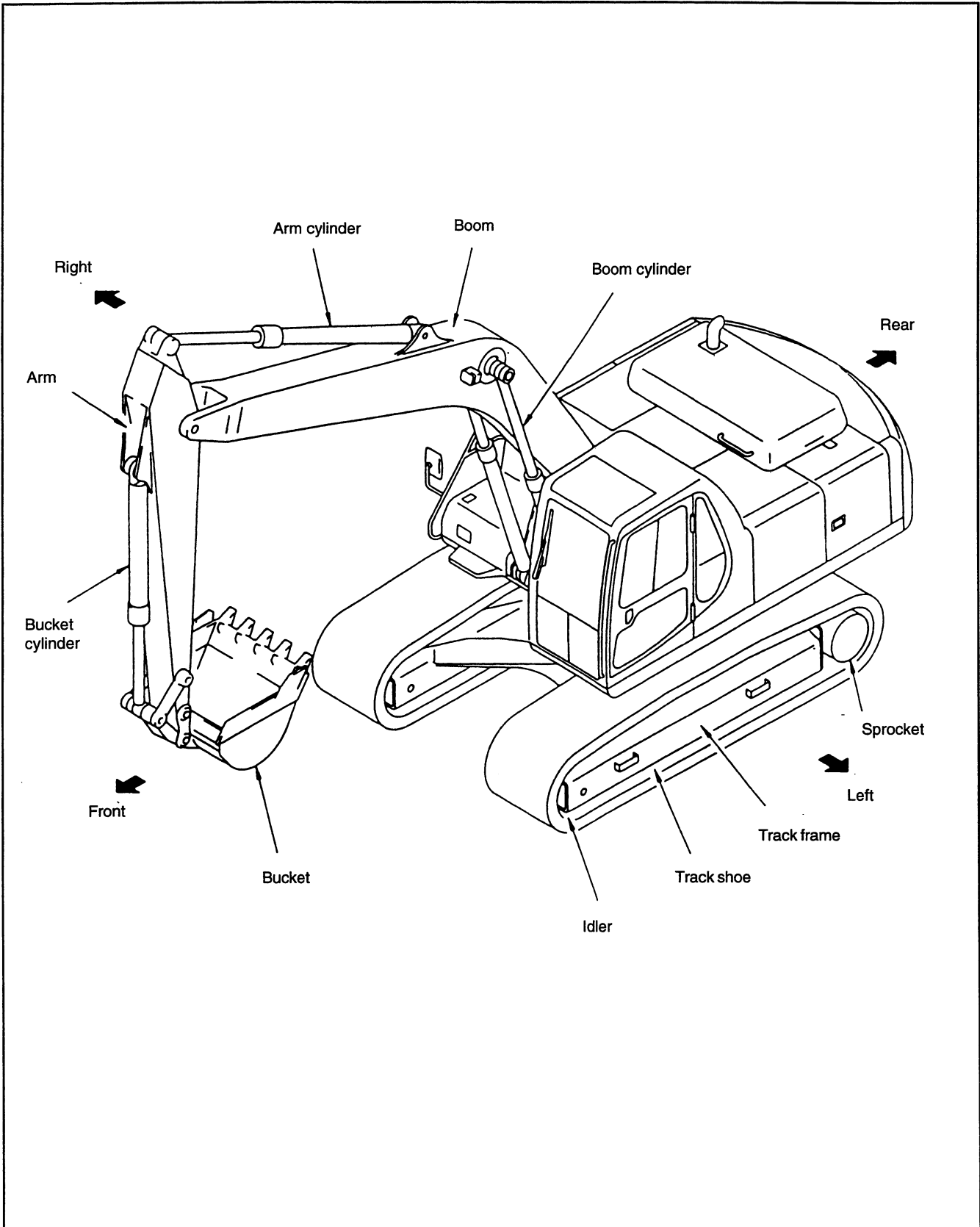

10.2 GENERAL VIEW OF CONTROLS AND GAUGES

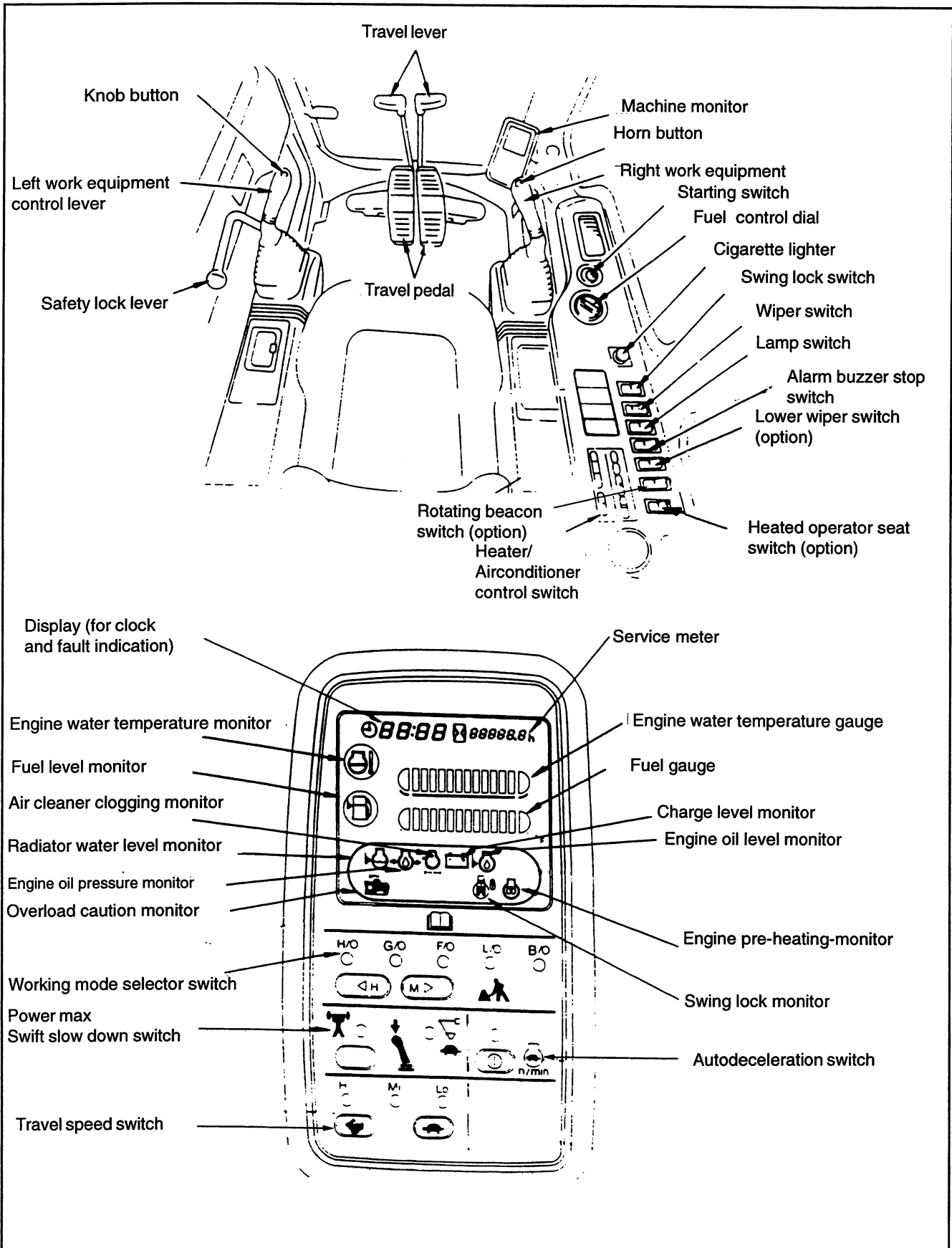

11. EXPLANATION OF COMPONENTS

The following is an explanation of the devices needed for operating the machine.

To carry out suitable operations correctly and safely, it is important to understand fully the methods of operating the equipment and the meanings of the displays.

11.1 MACHINE MONITOR

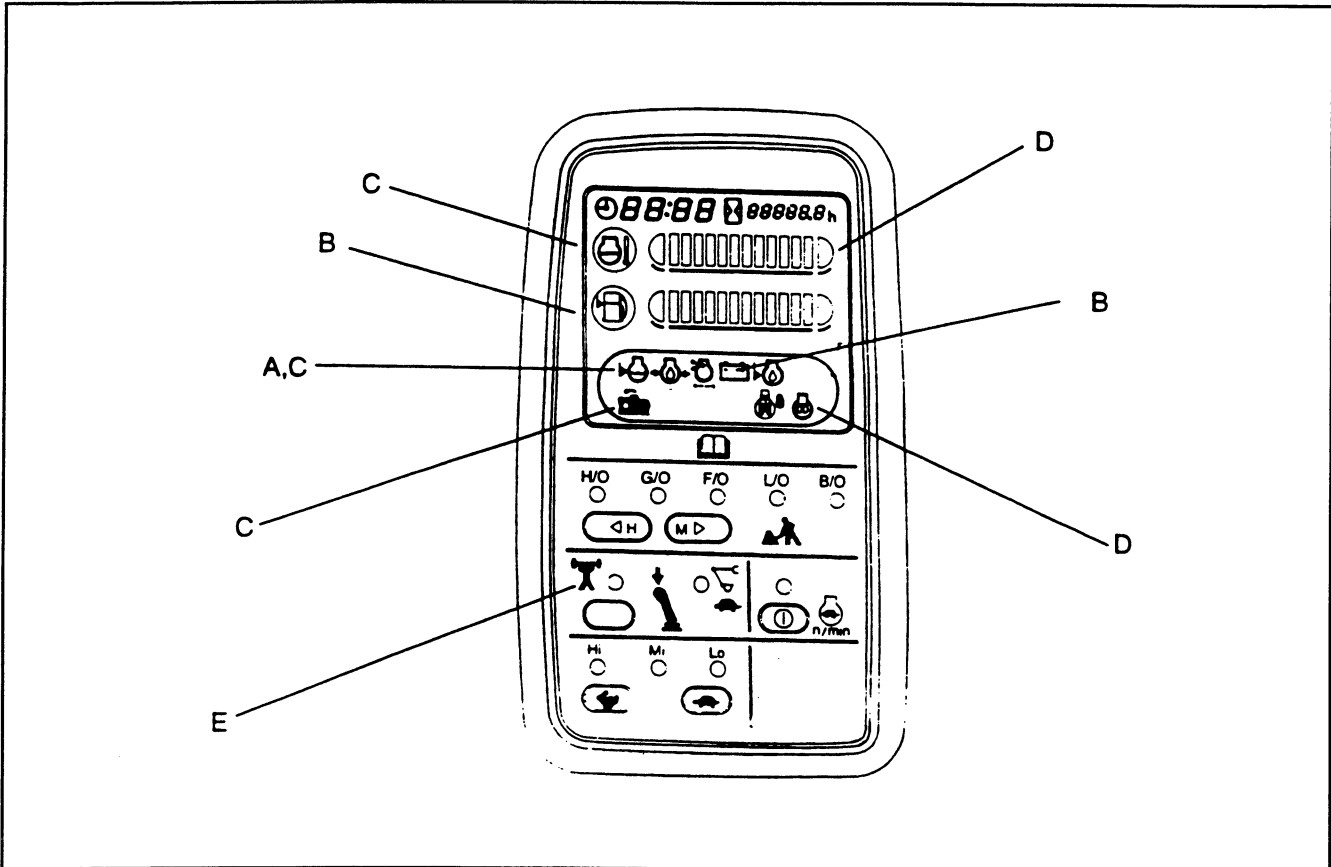

A. BASIC CHECK ITEMS (11.1.1)

This displays the basic items that should be checked before starting the engine.

If there is any abnormality, the appropriate monitor lamp will flash.

NOTICE

When carrying out checks before starting, do not simply rely on the monitor. Always refer to the periodic maintenance items or 12. "OPERATION" to carry out the checks.

B. CAUTION ITEMS (11.1.2)



If these monitor items flash, check and repair the appropriate location as soon as possible.

These are items which need to be observed while the engine is running. If any abnormality occurs, items which need to be repaired as soon as possible are displayed.

If there is any abnormality, the appropriate monitor lamp will flash to indicate the location of the abnormality.

C. EMERGENCY STOP ITEMS (11.1.3)



If these monitors items flash, stop operations immediately, then check and repair the appropriate location.

These are items which need to be observed while the engine is running. If any abnormality occurs, items which need to be repaired immediately are displayed.

If there is any abnormality, the appropriate monitor lamp will flash to indicate the location of the abnormality and the buzzer will sound.

D. METER DISPLAY PORTION (11.1.4)

This portion consists of pre-heating monitor, swing lock monitor, engine water temperature gauge, fuel gauge and display.

E. SWITCHES (11.1.5)

The switches are used for setting clock time and for selecting working mode and travel speed.

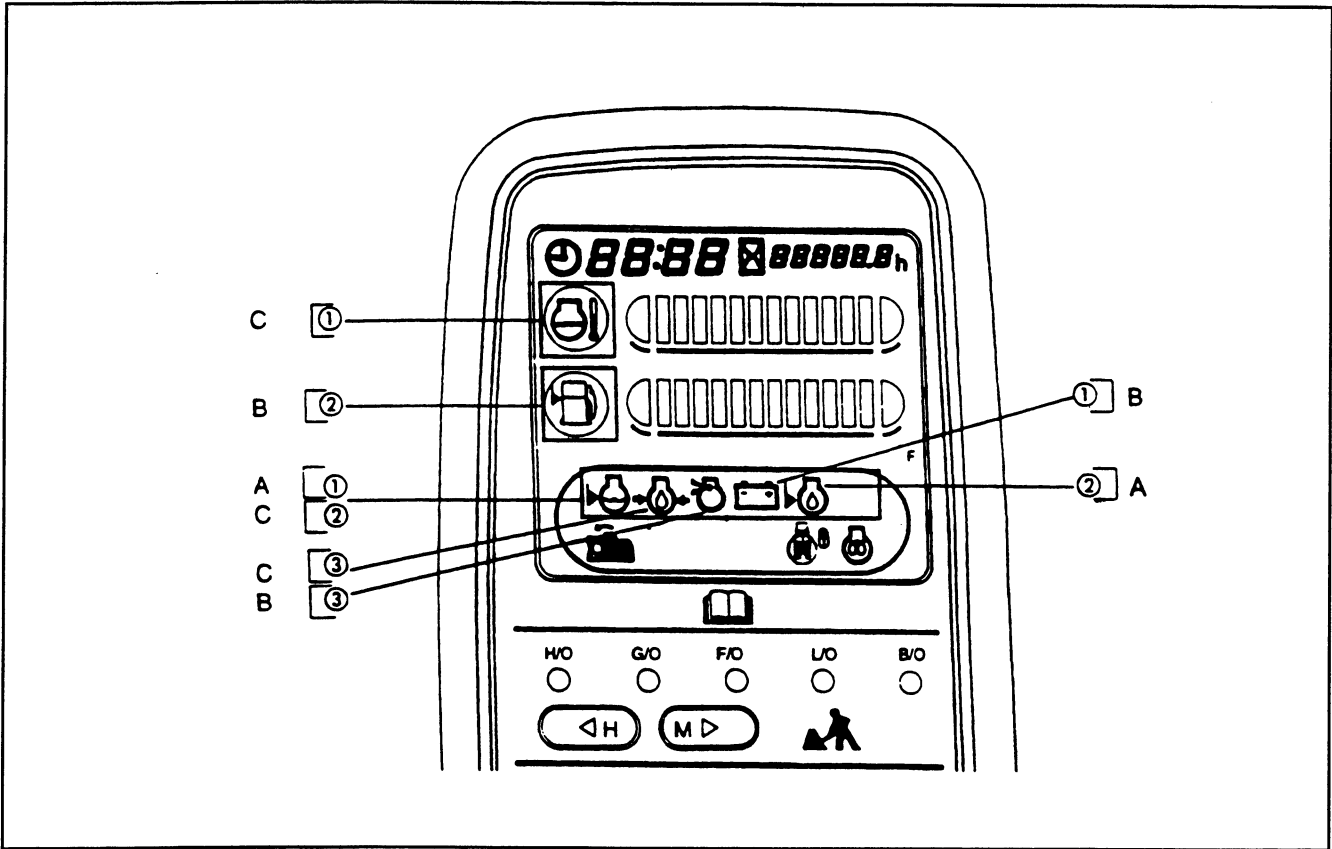

11.1.1 A: BASIC CHECK ITEMS

NOTICE

Do not rely on the “BASIC CHECK ITEMS” only for the check before starting

Always refer to the periodic maintenance items or 12. “OPERATION” to carry out the checks.

1. RADIATOR WATER LEVEL

This warns that the radiator cooling water level is too low. If the monitor lamp flashes, check the cooling water level in the radiator and reserve tank, and add water.

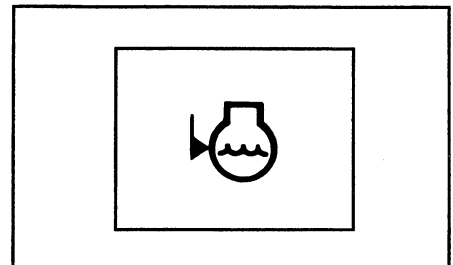

2. ENGINE OIL LEVEL

This warns that the oil level in the engine oil pan is too low. If the monitor lamp flashes, check the oil level in the engine oil pan, and add oil.

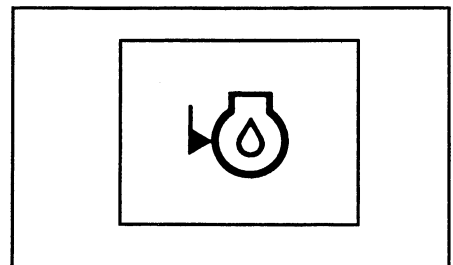

11.1.2 B: CAUTION ITEMS



CAUTION

If the caution monitor lamp flashes, repair the problem as soon as possible.

1. CHARGE LEVEL

This monitor indicates an abnormality in the charging system while the engine is running. If the monitor lamp flashes, check the V-belt tension. If any abnormality is found, see "16.6 OTHER TROUBLE".

REMARK

While the starting switch is ON, the lamp will remain lit and will go off once the engine is started.

2. FUEL LEVEL

If the fuel drops below 55 litres (14.5 US gal, 12.2 UK gal), the lamp will flash. Top up the fuel before this.

3. AIR CLEANER CLOGGING

This warns that the air cleaner is clogged.

If the monitor lamp flashes, stop the engine then inspect and clean the air cleaner.

4. OVERLOAD CAUTION (When lifting)

This warns that the machine is close to tipping due to the load (an audible warning is also given), if the warning is given lower the load. Refer to the lifting capacity chart for safe load.

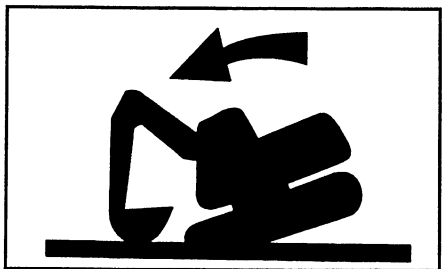
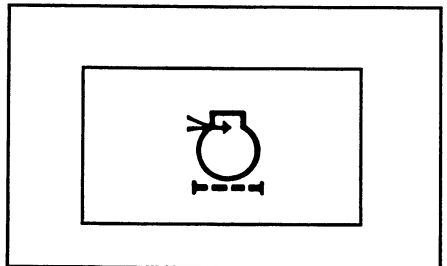
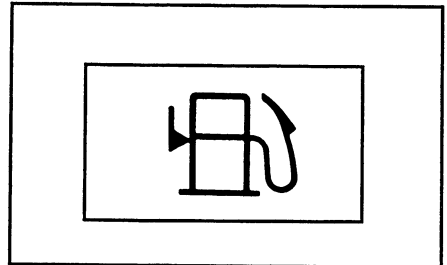
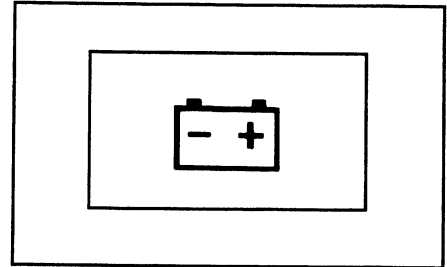

11.1.3 C: EMERGENCY STOP ITEMS



If any monitor lamp flashes, stop the engine or run it at low idling, and take the following action.

1. ENGINE WATER TEMPERATURE

If the temperature of the engine cooling water becomes abnormally high, the monitor lamp flashes, and the overheat prevention system is automatically actuated to reduce the engine speed.

Stop operations and run the engine at low idling until the engine water temperature gauge enters the green range.

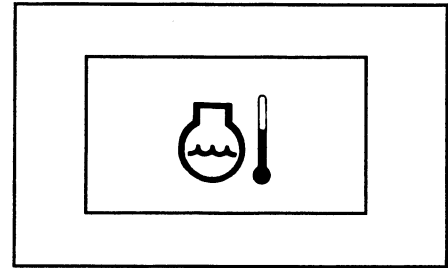

2. RADIATOR WATER LEVEL

If the radiator water level drops, the monitor lamp flashes. Stop the engine, check the radiator water level, and add water if necessary.

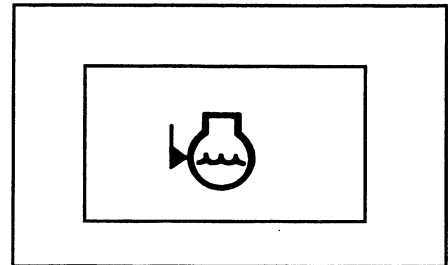

3. ENGINE OIL PRESSURE

If the engine oil pressure drops below the normal pressure, the monitor lamp flashes. At this item, stop the engine and inspect it according to 16.6 "OTHER TROUBLE."

REMARK

While the starting switch is ON, the lamp remains lit and goes off once the engine is started. When the engine starts, the buzzer may sound for a short time, however, this does not indicate a fault.

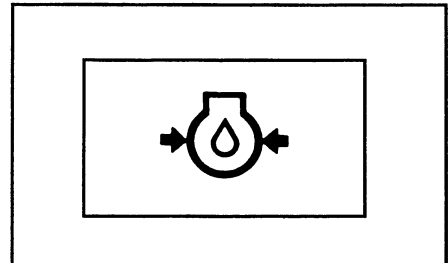

11.1.4 D: METER DISPLAY PORTION

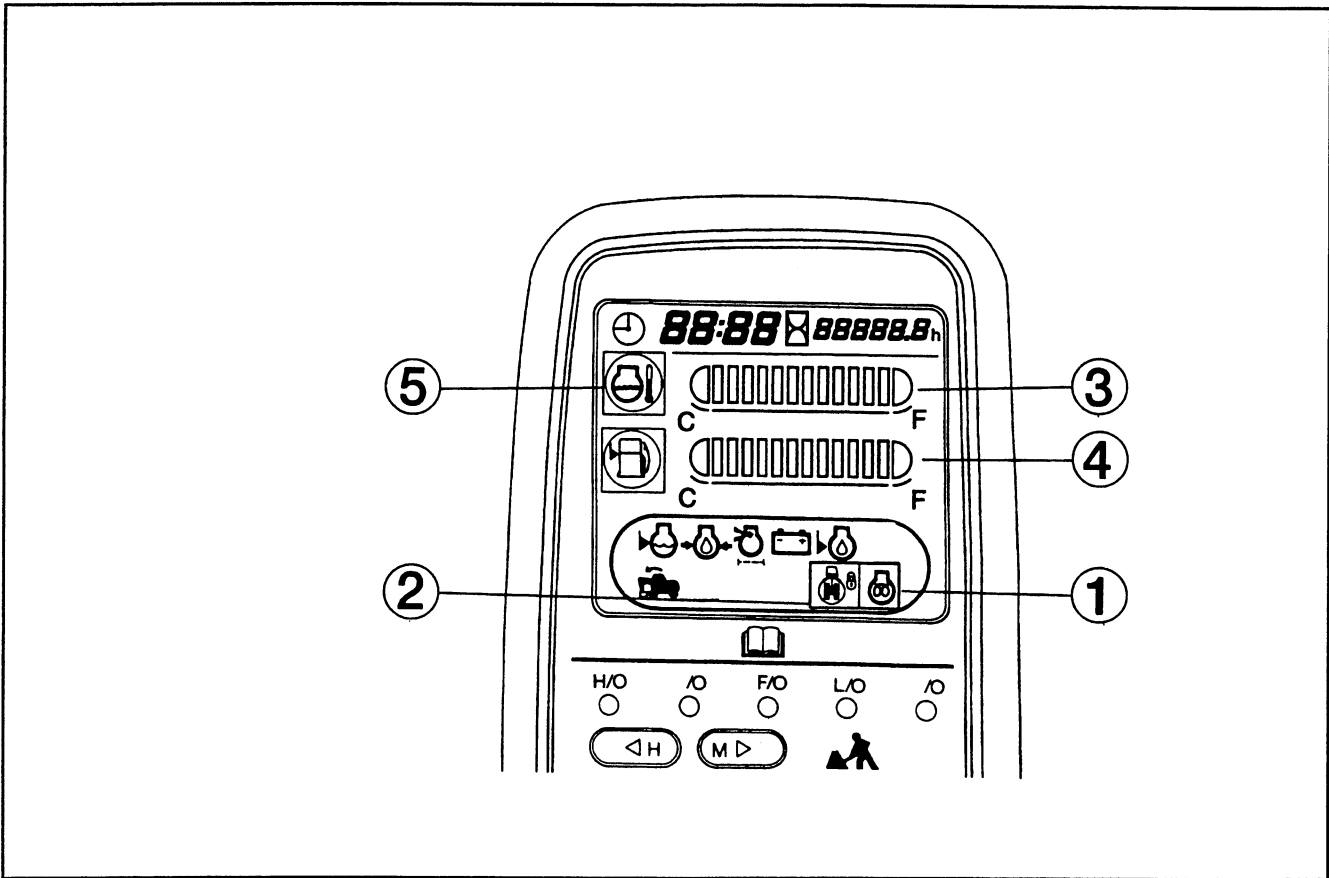

PILOT DISPLAY

When the starting switch is ON, the pilot display lights up when the display items are functioning.

1. ENGINE PRE-HEATING MONITOR

This monitor lamp indicates the pre-heating time required when starting the engine at an ambient temperature below 0°C.

The monitor lamp lights when the starting switch is turned to HEAT position and flashes after about 30 seconds to show that the pre-heating is completed. (The monitor lamp will go off after about 10 seconds.)

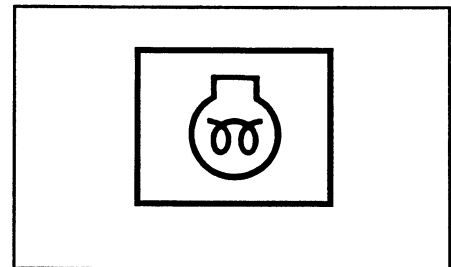

2. SWING LOCK MONITOR

This informs the operator that the swing lock is being actuated. Actuated: Lights up

When the swing lock switch is turned ON (ACTUATED), the monitor lamp lights up.

When the swing lock override switch is turned on, this monitor lamp flashes.

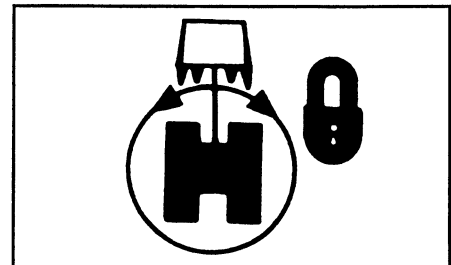

REMARK

A disc brake is installed in the swing motor to mechanically stop motor rotation.

The brake is always applied while the swing lock is actuated.

METERS

3. ENGINE WATER TEMPERATURE GAUGE

This gauge indicates the engine cooling water temperature.

If the temperature is normal during operation, the green range will light up.

If the red range lights up during operation, the overheat prevention system will be actuated.

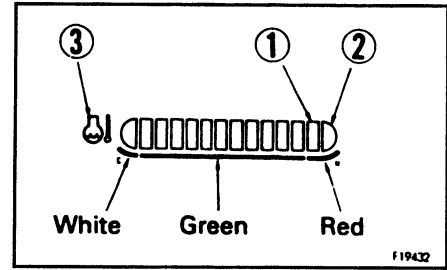

The overheat prevention system acts as follows.

Red range ① lights up:

Output horsepower drops, and water temperature monitor ③ flashes.

When red range ② lights up:

Engine speed is lowered further to low idling, engine water temperature monitor ③ lights up, and alarm buzzer sounds at the same time.

The overheat prevention system is actuated until the temperature enters the green range.

When red range ② lights, if the engine water temperature is reduced and the fuel control dial is turned to the low idling position, the display will be cancelled.

4. FUEL GAUGE

This gauge indicates the amount of fuel in the fuel tank. If the fuel level is normal during operation, the green range will light up.

If only the red range lights up during operation, there is less than 55 litres (14.5 US gal, 12.2 UK gal) of fuel remaining in the tank, so check and add fuel.

After the starting switch is turned ON, the correct level may not be displayed for a moment, but this does not indicate any abnormality.

When stopping the engine, turn the starting switch ON and check that the monitor lamps on items A, B, C and D and the meters light up.

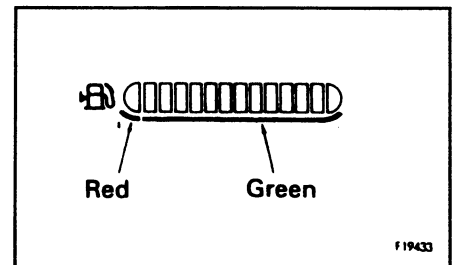

5. DISPLAY

This normally displays the clock time. If there is any abnormality, the type of failure is indicated when the starting switch is turned ON.

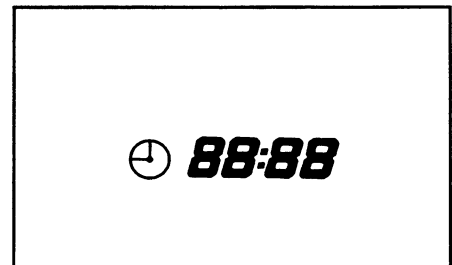

Manual setting

1. When the time is displayed, depress clock switch ① for 2.5 sec or more.
2. "TIME" flashes.
3. Pressing H switch ② increases hours and pressing M switch ③ increases minutes. If switch ② or ③ is pressed for 2.5 seconds or more, hours or minutes increase continuously.
4. When the correct time is reached, press clock switch ①. This completes clock setting.

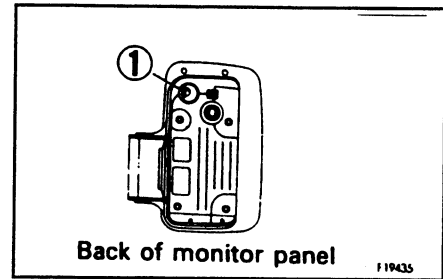

Correct time setting

1. When the time is displayed, depress the clock switch for 2.5 sec or more.
2. "TIME" flashes.
3. When SET switch ④ is pressed, the hour is rounded off for 0 to 14 minutes and rounded up for 45 to 59 minutes.
 [Examples) 10:14 becomes 10:00 /rounded off)
 10:45 becomes 11:00 (rounded up)
 When SET switch (4) is pressed at the time signal or standard clock, the correct time is obtained.
4. When the correct time is reached, press clock switch ①. This , completes clock setting.

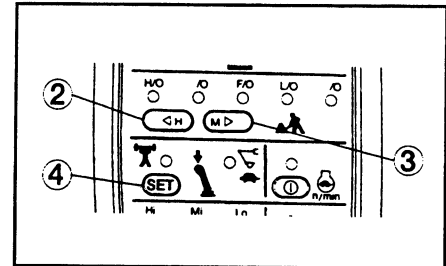

If the machine has a fault, error information appears while the starting switch is turned ON. The monitor flashes and displays all error informations sequentially.

Monitor indications	Error mode
E02	TVC valve system error
E03	Swing brake system error
E05	Governor system error
CALL	Non-operating error

If any of these monitors flashes, see 16.6.4 "ELECTRONIC CONTROL SYSTEM".

6. SERVICE METER

This displays the accumulated hours of operation of the machine.

Use the display to determine the intervals for periodic maintenance. The service meter will advance while the engine is running even if the machine is not moving.

The service meter reading advances by 1 for every hour that the engine is running, regardless of the engine speed.

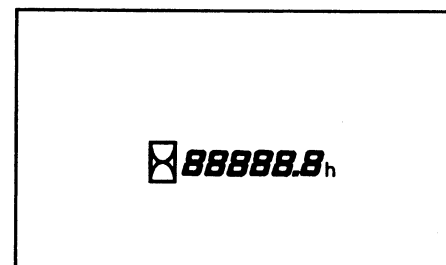

11.1.5 E: SWITCHES

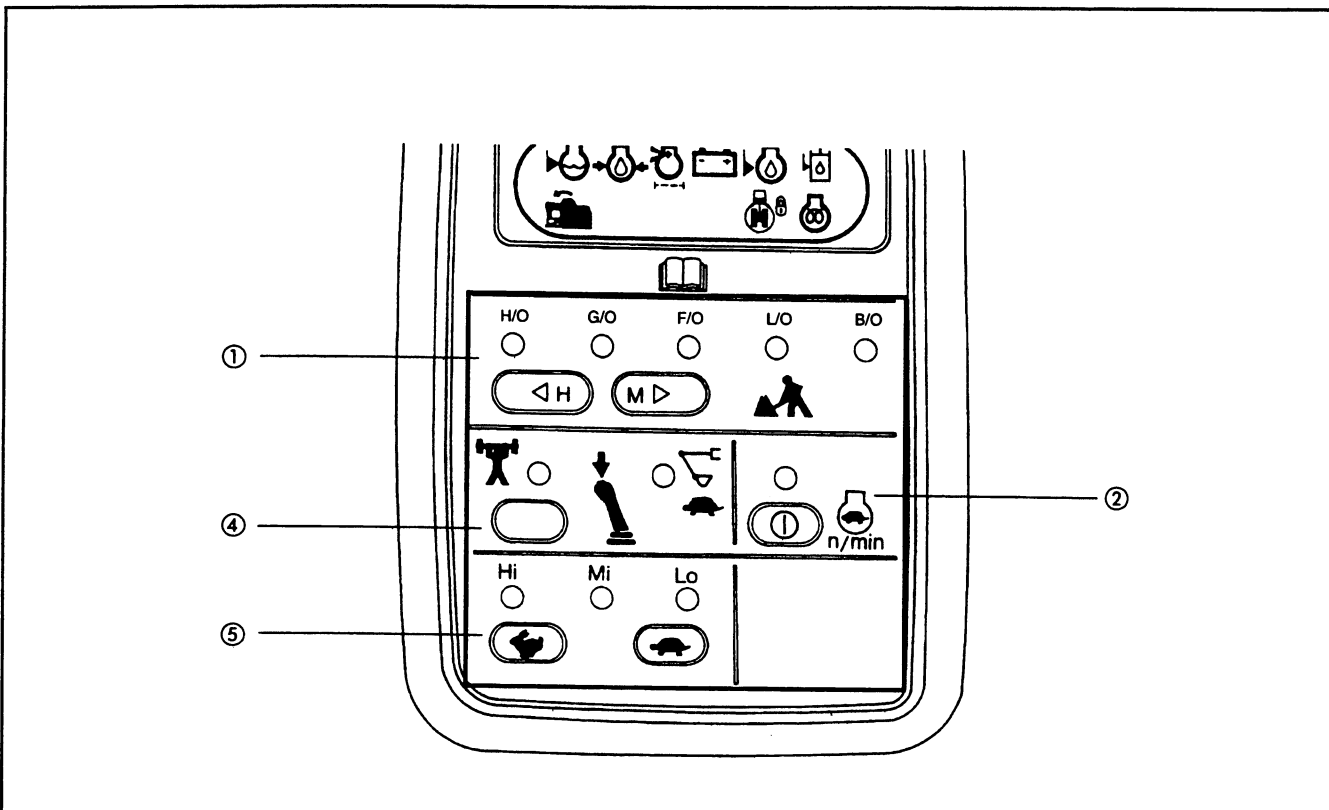

1. WORKING MODE SELECTOR SWITCH (Basic switch)

This switch is used to set the movement or power for the work equipment. By selecting the mode to match the working conditions, it is possible to carry out operations more easily.

H.O. (heavy-duty operation mode) lights up:

This is used for heavy-duty work.

G.O. (general operation model lights up:

This is used for ordinary work.

F.O. (finishing operation mode) lights up:

This is used for levelling or grading work.

L.O. (lifting operation mode) lights up:

This is used for fine control operations.

B.O. (breaker operation mode) lights up:

This is used for breaker work.

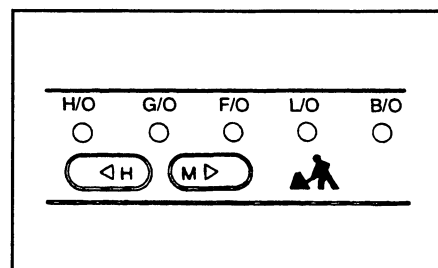

When starting the engine, G.O. (general operation) mode is automatically selected. Each time the switch is pressed, the mode selection changes.

NOTICE

When the breaker is used, never select the H.O. (heavy-duty operation) mode.

REMARK

H switch is also used for setting "hours" in the clock and M switch for setting "minutes". See 11.1.4-5 "DISPLAY".

2. AUTO-DECELERATION SWITCH (Selection switch)

This switch acts to activate the function that automatically lowers the engine speed and reduces fuel consumption when the control lever is at neutral.

ON lights up: Auto-deceleration is actuated.
 OFF: Auto-deceleration is cancelled.

Each time the switch is pressed, the auto-deceleration is actuated or cancelled.

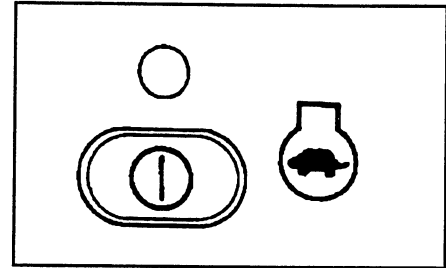

3. TRAVEL SPEED SWITCH

⚠ WARNING

If the Hi-Lo switch is operated when the machine is travelling, the machine may deviate even when travelling in a straight line. To prevent this, always stop the machine before operating the travel speed switch.

This is used to select the three travel speeds.

Lo lights up: Low speed travel
 Mi lights up: Mid range speed travel
 Hi lights up: High speed travel

When the engine is started, the travel speed is automatically set to Lo.

When travelling in Hi, the travel speed is automatically adjusted to match the travel surface on soft ground or when travelling uphill, so there is no need to operate this switch. The monitor indication keeps lamp Hi or Mi lighted.

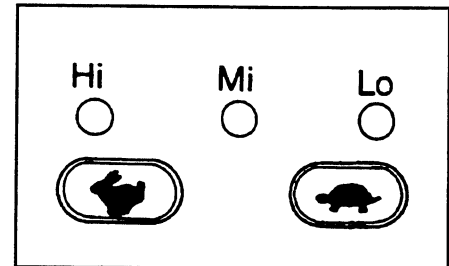

4. POWER MAX./SWIFT SLOW-DOWN SWITCH

During operations, the digging power can be increased and the speed reduced by a one-touch operation of the knob button (single click while pushing).

Power max. (power up) lights up:

When the working mode is heavy-duty and general operation mode only, the power can be increased while the knob button is being pressed. Even if the knob button continues to be pressed, the increase in power finishes after approx. 8.5 sec.

Swift slow-down (speed down) lights up:

When the working mode is heavy-duty operation and general operation mode only, the speed is reduced while the knob button is being pressed.

When the engine is started, the power max. lamp lights up. Each time this switch on the monitor panel is pressed, the mode is switch.

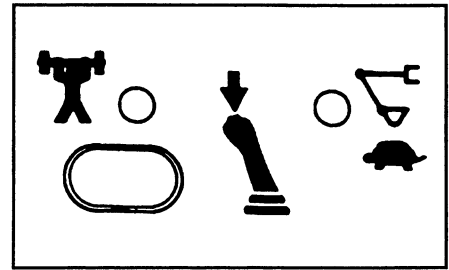

11.2 SWITCHES

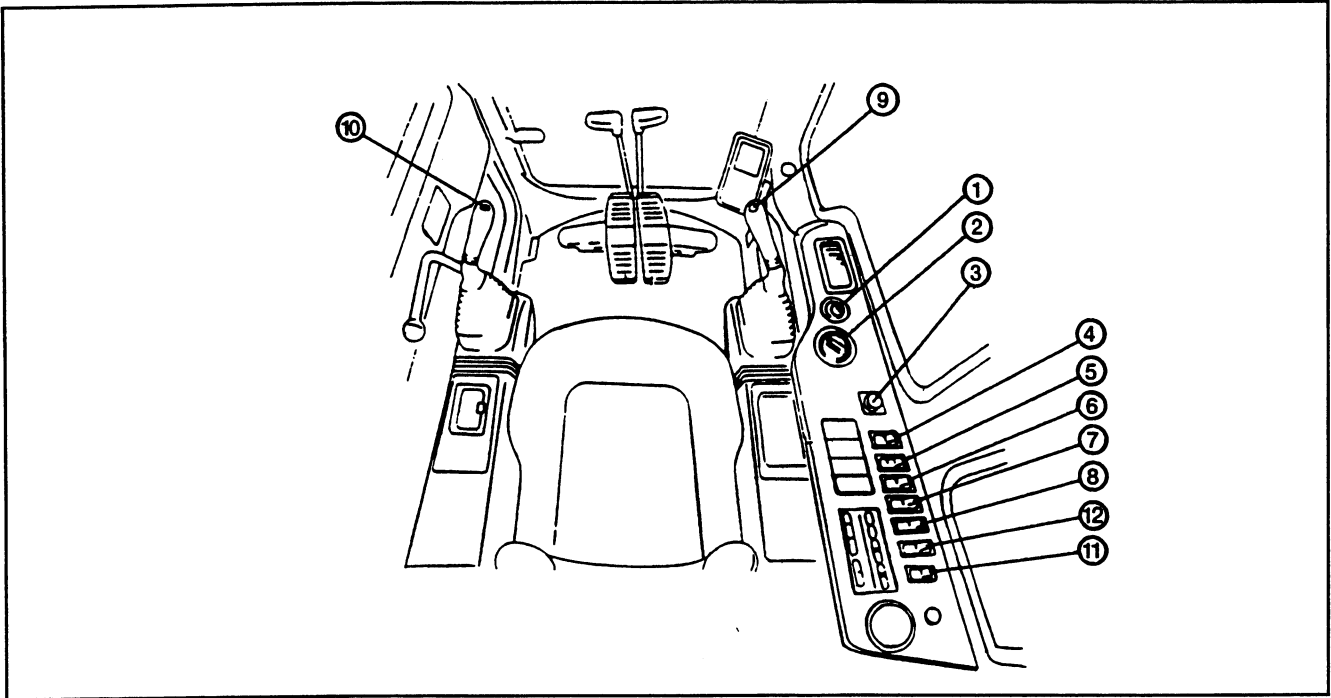

1. STARTING SWITCH

This switch is used to start or stop the engine.

OFF position

The key can be inserted or withdrawn. Except for the cab lamp, radio (if fitted) and clock, the switches for the electric system are all turned off and the engine is stopped.

ON position

Electric current flows in the charging and lamp circuits.

Keep the starting switch key at the ON position while the engine is running.

START position

This is the engine-start position. Keep the key at this position during cranking. Immediately after starting the engine, release the key which will automatically return to the ON position.

HEAT (preheat) position

When starting the engine in winter, set the key to this position. When the key is set to the HEAT position, the pre-heating monitor lights up. Keep the key at this position until the monitor lamp goes off. Immediately after the pre-heating monitor goes off, release the key. The key automatically returns to the OFF position. Then, start the engine by turning the key to the START position.

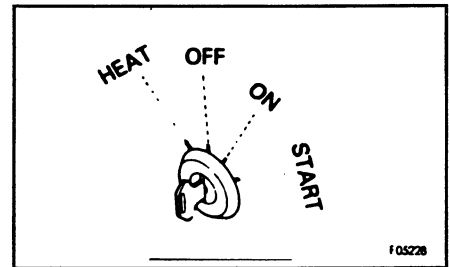

11. EXPLANATION OF COMPONENTS

2. FUEL CONTROL DIAL (WITH AUTO-DECELERATION MECHANISM)

This adjusts the engine speed and output.

- (1) Low idling (MIN): Turned fully to the left
- (2) Full speed (MAX): Turned fully to the right

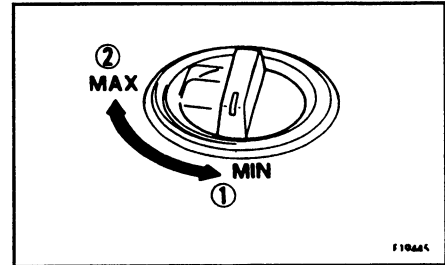

3. CIGARETTE LIGHTER

This is used to light cigarettes. To use, push the lighter in. After a few seconds it will spring back.

Pull out the lighter and light your cigarette.

Nothing may be connected to the cigarette lighter without the prior permission of an authorised Komatsu distributor.

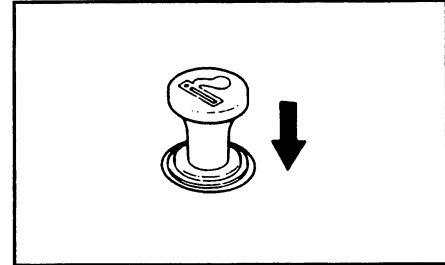

4. SWING LOCK SWITCH

WARNING

- When the machine is travelling under its own power, or when the swing is not being operated, always set the switch to the ON (ACTUATED) position.
- On a slope, the work equipment may swing to the down side even if the swing lock switch is located at the ON position. Be careful concerning this point.

This switch is used to lock the upper structure so that it cannot swing. ON position (actuated):

The swing lock is always applied, and the upper structure will not swing even if the swing is operated. In this condition, the swing lock lamp lights up.

OFF position (cancelled):

The swing lock is applied only when the swing control lever is at neutral; when the swing control lever is operated, it is cancelled.

The swing lock is actuated approx. 4 seconds after the swing lever is placed in neutral.

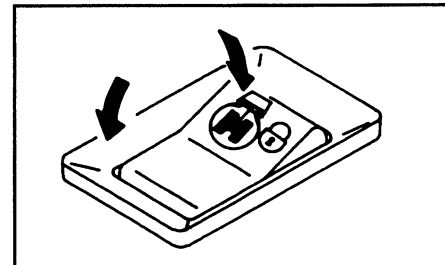

5. WIPER SWITCH

This switch actuates the front window wiper.

- ① OFF: The wiper stops.
- ② ON: The wiper moves continuously
- ③ Window washer fluid is sprayed out: When the switch is released, it returns to ②.
- ④ ON: The wiper moves intermittently.
- ⑤ Window washer fluid is sprayed out: When the switch is released, it returns to ④.

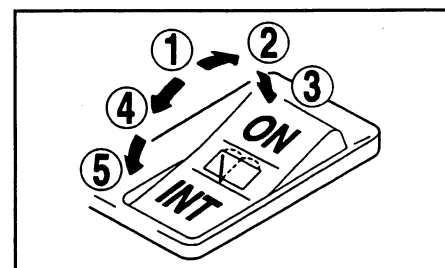

6. LAMP SWITCH

This switch turns on the working lamps and monitor illumination.

- ① OFF
- ② Standard work lamps
- ③ Standard and additional work lamps (if fitted)

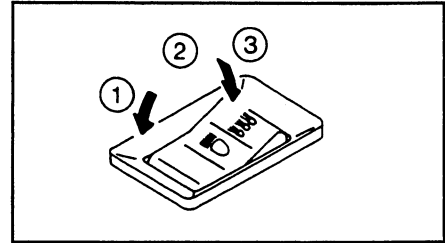

7. ALARM BUZZER STOP SWITCH

This is used to stop the alarm buzzer when it has sounded to warn of some abnormality in the EMERGENCY STOP ITEMS while the engine is running.

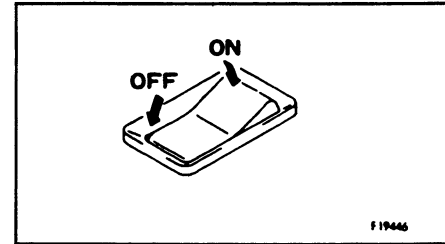

8. LOWER WIPER SWITCH (If fitted)

This switch actuates the front lower wiper.

OFF: wiper stops

ON: wiper moves continuously

NB. Do not operate with front lower screen removed.

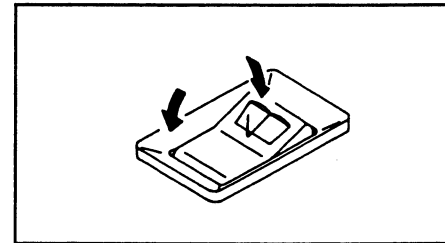

9. HORN BUTTON

When the button at the tip of the right work equipment control lever is pressed, the horn will sound.

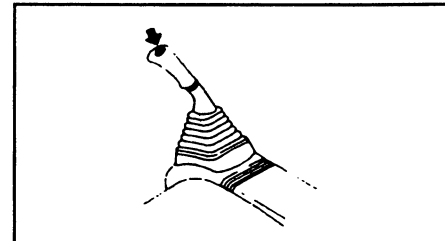

10. KNOB BUTTON

The button at the tip of the left work equipment control lever is used to actuate the power max./swift slow-down functions. Press the button once (single click) and keep it depressed. In the heavy-duty and general operation modes, the power max. function actuates for max. 8.5 seconds and the swift slow-down function actuates while the button is depressed.

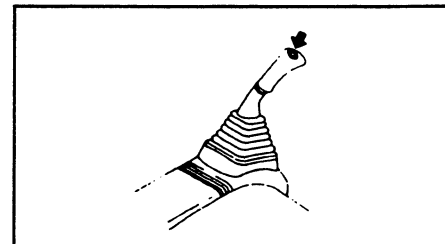

11. HEATED OPERATOR SEAT SWITCH (If fitted)

This switch is used to switch on the heated seat.

OFF: seat not heated

ON : seat heated

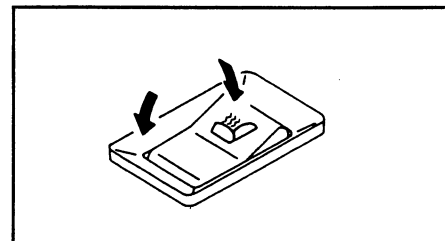

12. BEACON SWITCH (If fitted)

This switch is used to switch on the rotating beacon.

OFF

ON: beacon lights lights and rotates

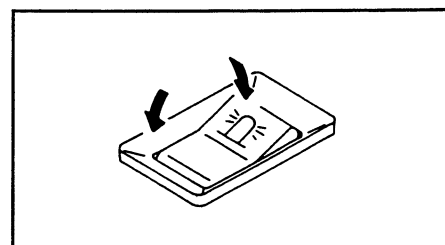

11. EXPLANATION OF COMPONENTS

13. CAB LAMP SWITCH

This lights up the cab lamp.

ON position: Lights up

The cab lamp can be turned on even when the starting switch is at the OFF position, so be careful not to leave it on by mistake.

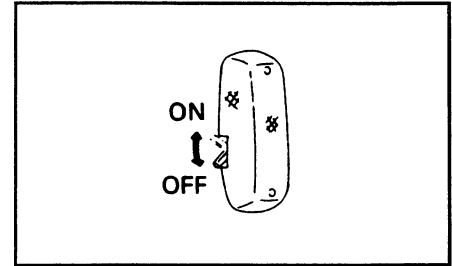

14. PUMP CONTROL OVERRIDE SWITCH

When normal: Switch is down

When abnormal: When the monitor display shows E02 (TVC valve system error), it is possible to carry out operation when this switch is moved up. The pump control override switch is designed to allow operations to be carried out for a short period when there is an abnormality in the pump control system (TVC valve system error). The abnormality must be repaired immediately.

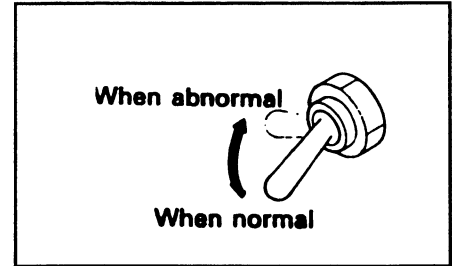

15. SWING LOCK OVERRIDE SWITCH

When normal: Switch is down

When abnormal: When the monitor display shows E03 (swing brake system error), the brake is cancelled and it becomes possible to swing the upper structure when this switch is moved up, so normal operations can be carried out. However, the swing brake remains cancelled.

The swing lock override switch is designed to allow operations to be carried out for a short period when there is an abnormality in the swing brake electrical system (swing brake system error). The abnormality must be repaired immediately.

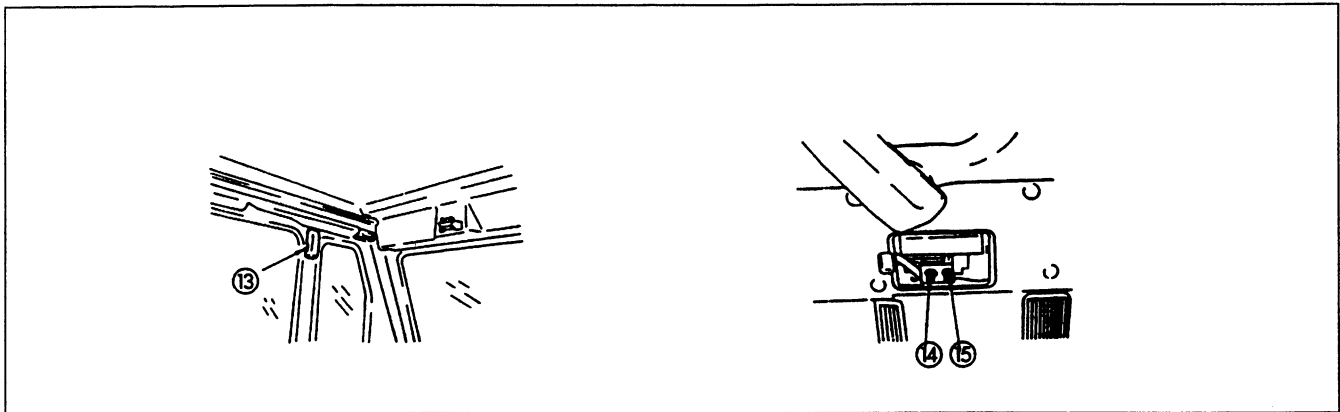
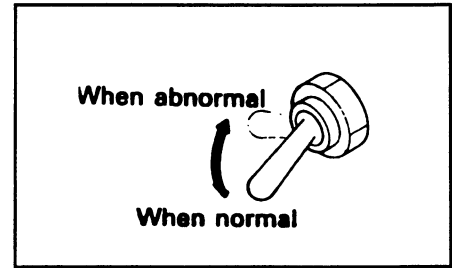

11.3 CONTROL LEVERS, PEDALS

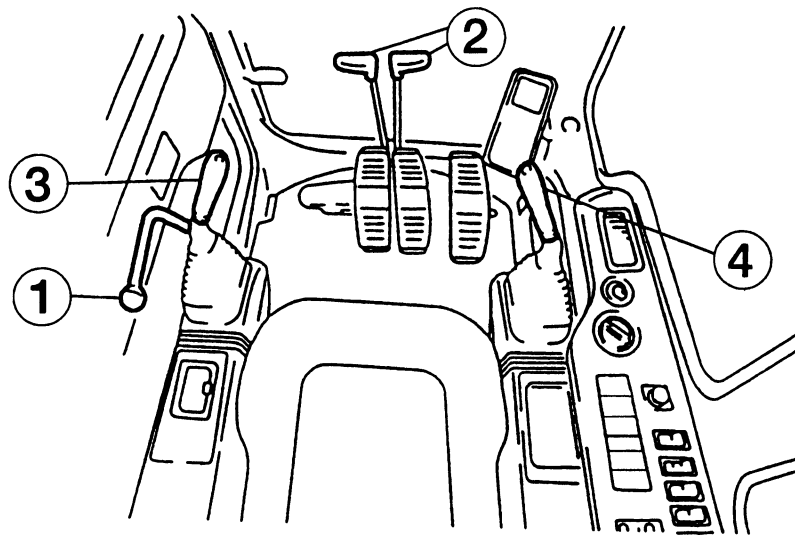

1. SAFETY LOCK LEVER

WARNING

- When leaving the operator's compartment, set the safety lock lever securely to the LOCK position. If the control levers are not locked, and they are touched by mistake, this may lead to a serious accident.
If the safety lock lever is not placed securely in the LOCK position, the control levers may not be properly locked. Check that the situation is as shown in the diagram.
- When the safety lock lever is raised, take care not to touch the work equipment control lever. If the safety lock lever is not properly locked at the upper position, the work equipment and swing will move, creating a potentially dangerous situation.
- When the safety lock lever is lowered, take care not to touch the work equipment control lever.

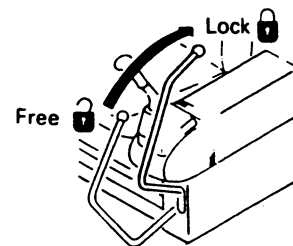

11. EXPLANATION OF COMPONENTS

This lever locks the work equipment, swing and attachment controls.

This lock lever is a hydraulic lock, so even if it is in the lock position, the work equipment control lever will move, but the work equipment and swing motor will not work.

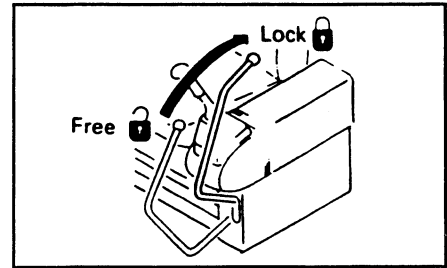

2. TRAVEL LEVERS (WITH PEDAL, AUTO-DECELERATION MECHANISM)

WARNING

- Do not put your foot on the pedal unless the machine is travelling. If you leave your foot on the pedal and press it by mistake, the machine will move suddenly, and this may lead to a serious accident.
- With the track frame facing to the rear, the machine will move in the reverse direction by forward travelling and in the forward direction by reverse travelling.
When the travel lever is used, check to see if the track frame is facing forward or backward. (If the sprocket is located to the rear, the track frame is facing forward.)

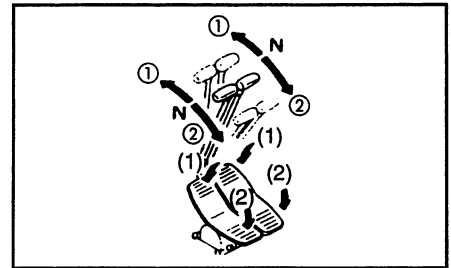

- ① FORWARD
The lever is pushed forward
(The pedal is angled forward)
 - ② REVERSE:
The lever is pulled back.
(The lever is angled back)
 - N (Neutral): The machine stops
- () This indicates operation of the pedal.

REMARK

Machines equipped with travel alarm (Option)

If the lever is shifted to the advance or reverse position from the neutral position, the alarm sounds to warn that the machine is starting to advance.

**3. LEFT WORK EQUIPMENT CONTROL LEVER
(with auto-deceleration device)**



WARNING

If any lever is operated when in the deceleration range, the engine speed will suddenly increase, so be careful when operating the levers.

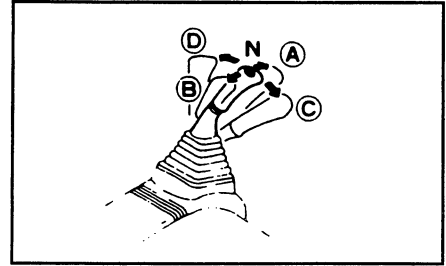

This lever is used to operate the arm and upper structure.

- | | |
|---------------|------------------|
| Arm operation | Swing operation |
| Ⓐ Arm OUT | Ⓒ Swing to right |
| Ⓑ Arm IN | Ⓓ Swing to left |
| N (Neutral) | |

When the lever in this position, the upper structure and the arm will be retained in the position in which they stop.

**4. RIGHT WORK EQUIPMENT CONTROL LEVER
(with auto-deceleration device)**



WARNING

If an lever is operated when in the deceleration range, the engine speed will suddenly increase, so be careful when operating the levers.

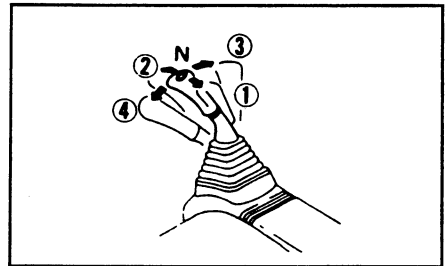

This lever is used to operate the boom and bucket.

- | | |
|----------------|------------------|
| Boom operation | Bucket operation |
| ① RAISE | ③ DUMP |
| ② LOWER | ④ CURL |
| N (Neutral) | |

When the lever in this position, the boom and the bucket will be retained in the position in which they stop.

For levers ②, ③ and ④, the engine speed changes as follows because of the auto-deceleration mechanism.

- When the travel lever and work equipment control levers are at neutral, even if the fuel control dial is above the mid-range position, the engine speed will drop to a mid-range speed. If any of the levers are operated, the engine speed will rise to the speed set by the fuel control dial.
- If all control levers are set to neutral, the engine speed will drop by approx. 100 rpm, and after approx. 4 seconds, the engine speed will drop to the deceleration speed (approx. 1400 rpm).

11. EXPLANATION OF COMPONENTS

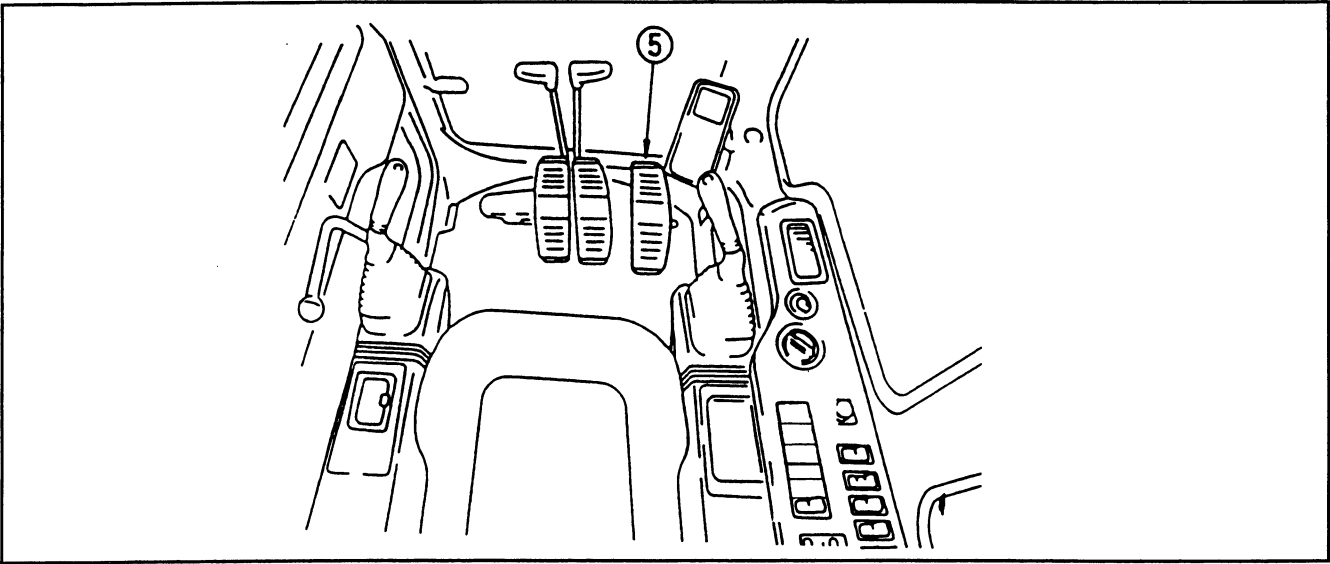

5. ATTACHMENT CONTROL PEDAL

⚠ WARNING

Do not put your foot on the pedal except when operating the pedal. If resting your foot on the pedal during operation, and it is depressed by accident, the attachment may move suddenly and cause serious damage or injury.

When breaker is installed

- When the front part of the pedal is depressed, the breaker is actuated.
 - Screw lock pin into hole in pedal to lock (Pedal is disabled. Unscrew completely to unlock).
 - Set the working mode to the breaker (B.O) and unlock pedal.
- When general attachment is installed:
- When the pedal is depressed, the attachment is actuated.
 - Unlock the pedal to operate.
- When no attachment is fitted or when attachment operation is not required:
- Lock pedal using lock pin.

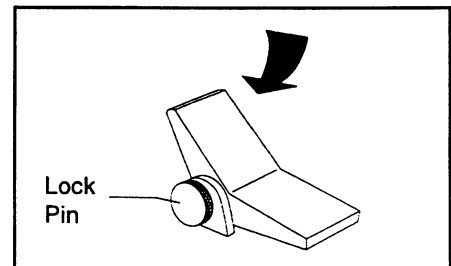

HYDRAULIC OIL FLOW

When the front of the pedal is depressed, the oil flows to the left piping for the work equipment; when the rear of the pedal is depressed, the oil flows to the right piping for the work equipment. (When the breaker is installed, only the front of the pedal is used.)

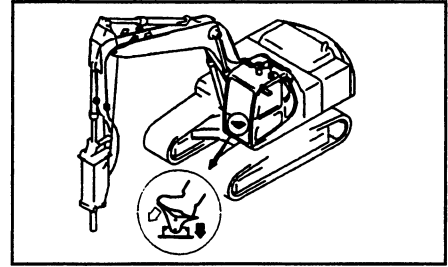

11.4 ROOF HATCH

When opening

1. Lock the safety lock lever securely.
2. Open roof hatch by pulling lock ② located on both sides, then push up and open the ceiling window grasping grip ①.

When closing

Close the ceiling window grasping grip ① and lock it with lock ②. If the lock cannot be applied, open and close the ceiling window again.

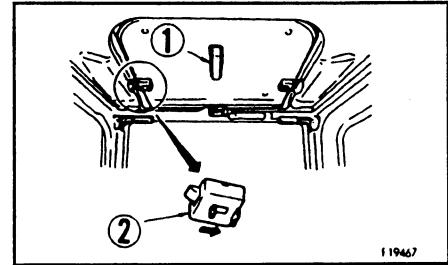

11.5 FRONT WINDOW

⚠ WARNING

When opening the front window, always hold grip firmly with both hands and pull up. If you use only one hand, your hand may slip and get caught.

It is possible to store (pull up) the front window (top) in the roof of the operator's compartment.

When opening

⚠ WARNING

When the front window is open, there is danger that it will fall, so always lock it with left and right lock pins Ⓐ.

1. Place the work equipment on flat ground and stop the engine.
2. Securely lock the safety lock lever.

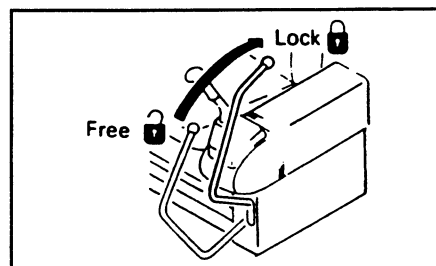
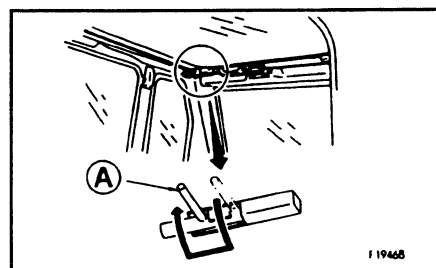

3. Confirm that the wiper is stored inside the right frame.

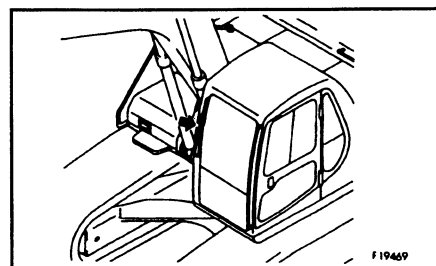

4. Pull lock pins Ⓐ at the top left and right sides of the front window to the inside to release the lock.

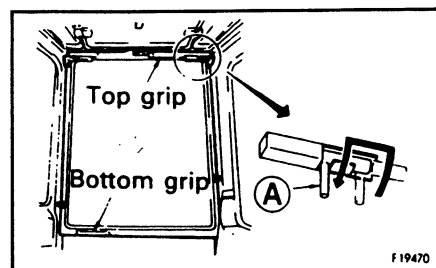

11. EXPLANATION OF COMPONENTS

- From the inside of the operator's cab, hold the bottom grip with the left hand and the top grip with the right hand, pull up the window, and push it in fully until it is locked by catch ©.

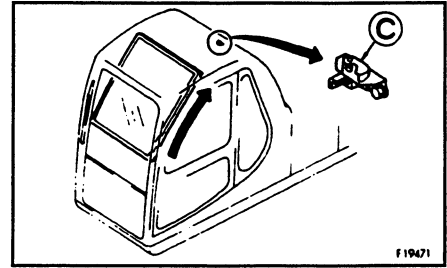

- Lock with lock pins Ⓐ on the left and right sides.

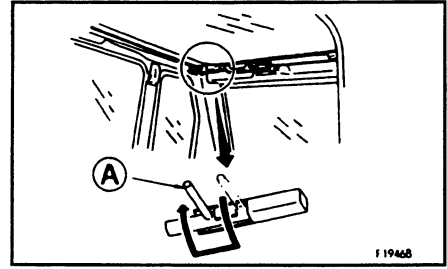

When closing

WARNING

When closing the window, lower it slowly and be careful not to get your hand caught.

- Place the work equipment on a flat ground and stop the engine.
- Securely lock the safety lock lever.

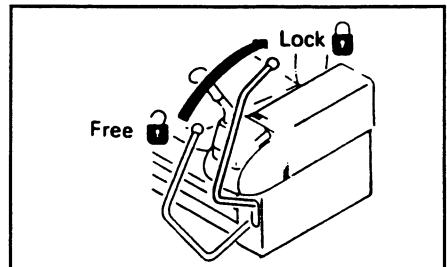

- Release the lock pin Ⓐ.

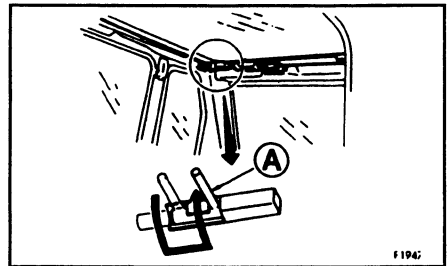

- Hold the grip at the bottom of the front window with your left hand and the grip at the top with your right hand, release the lock of catch © with your right thumb, then pull the top grip slowly and lower the front window. When releasing the lock of catch ©, push release lever Ⓓ in the direction of the arrow to release the lock.

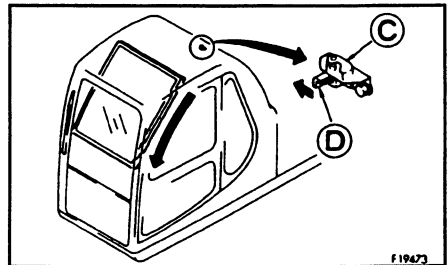

5. Lock securely with lock pins ④ at the left and right sides

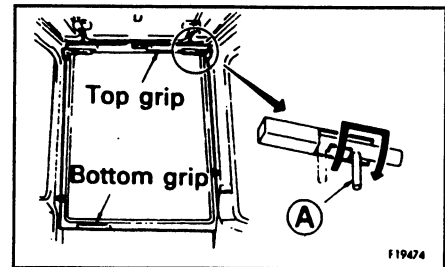

Removing front window (bottom)

Ensure lower wiper (if fitted) is in correct park position.

With the front window open, remove lock pins ⑤, and the bottom part of the front window can be removed.

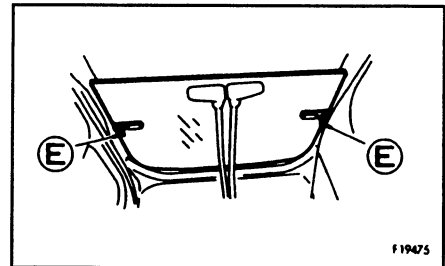

Store the removed bottom part of the front window at the rear of the operator's cab and lock with lock pins ⑤.

Notice

Do not operate lower wiper (if fitted) when front window (bottom) is removed.

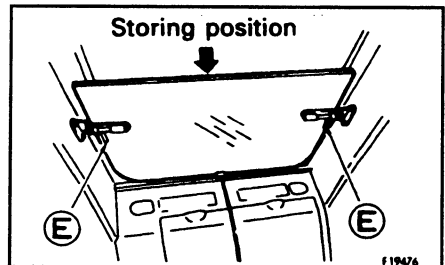

11.6 DOOR LOCK

Use the door lock to fix the door in position after opening it.

1. The door will become fixed in place when it is pressed against catch ①.
2. To release the lock, press knob ② down at the left side of the operator's seat to release the catch.
When fixing the door, fix it firmly to the catch.

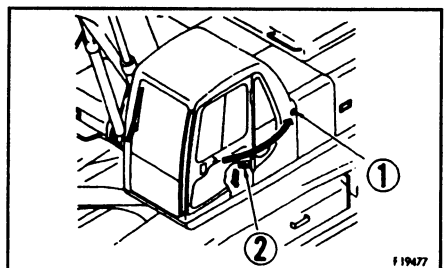

11.7 CAP, COVER WITH LOCK

The fuel filler, operator's cab, engine hood, tool box cover, right side door and left side door of the machine body are fitted with locks.

Use the starting switch key to lock or unlock these places.

11.7.1 METHOD OF OPENING AND CLOSING CAP WITH LOCK (For the fuel tank filler port)

To open the cap

1. Insert the key into the cap.
2. Turn the key clockwise, align the match mark on the cap with the rotor groove, then remove the cap.

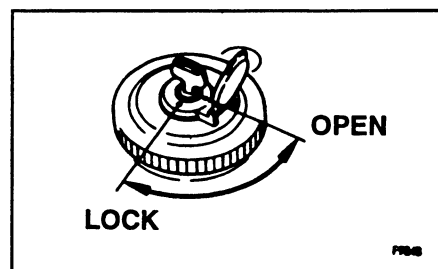

To lock the cap

1. Turn the cap into place.
2. Turn the key and take the key out.

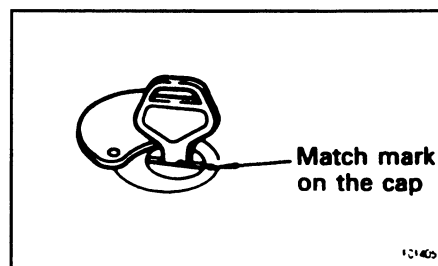

Insert the key as far as it will go. If the key is turned before it is inserted all the way, it may break.

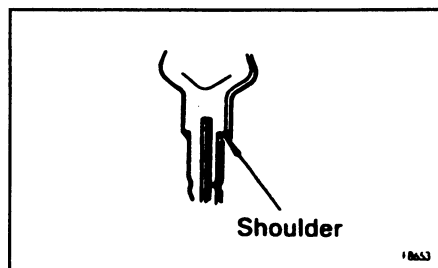

11.7.2 METHOD OF OPENING AND CLOSING COVER WITH LOCK (cover with lock)

To open the cover (locked cover)

1. Insert the key.
2. Turn it counterclockwise and open the cover by pulling the cover grip.

To lock the cover

1. Close the cover and insert the key.
2. Turn the key clockwise and take the key out.

11.8 LUGGAGE TRAY

This tray is located to the rear of the operator's seat. Always keep the operation & maintenance manual in this box for easy reading access.

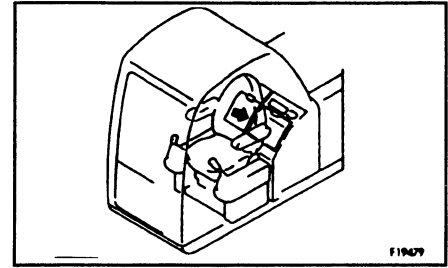

11.9 ASHTRAY

This is on the side of the operator's seat. Always make sure that you extinguish the cigarette before closing the lid.

11.10 HEATER

11.10.1 VIEW OF CONTROL PANEL

1. Inlet air control slider

Change between internal air recirculation & external fresh air intake.

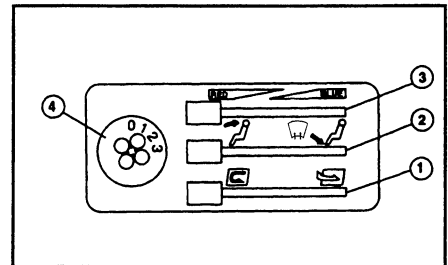

Purpose	Internal air circulation. This is used when wishing to quickly warm the cab.	External air intake. This is used for fresh air intake or to remove condensation on windows or when the air inside the cab is stale.
Lever position.		

2. Air outlet selector slider

The operator can select a suitable outlet as required.

Purpose	Sending air to upper area of operator's seat and defrosting upper part of front window	Sending air to lower area of operator's seat and defrosting lower part of front window.
Lever position		
Air outlets		

For complete defrosting of the front window, set the selector to the mid-point of its stroke.

11. EXPLANATION OF COMPONENTS

3. Temperature control slider

This adjust out air temperature

To increase temperature of outlet air: move slides to left (red)

To decrease temperature of outlet air: move slides to right (blue)

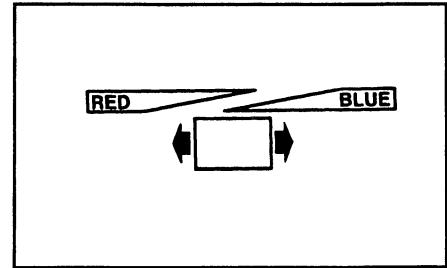

4. Air flow selector switch

This switch adjust air flow in three steps

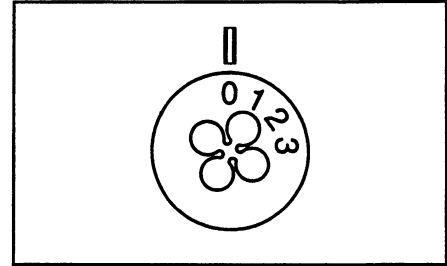

5. Defroster selector lever

This lever is used to remove condensation or ice from the lower part of front window.

Selector lever forward: defrost

Selector lever backward: warms operator's feet

Defroster is available when air outlet slider is in the position shown

marked: 

Ⓐ DEFROSTER

Ⓑ FEET

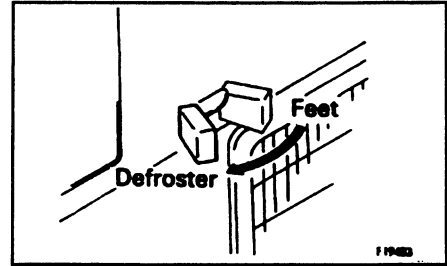

11.11 AIR CONDITIONER(OPTION)

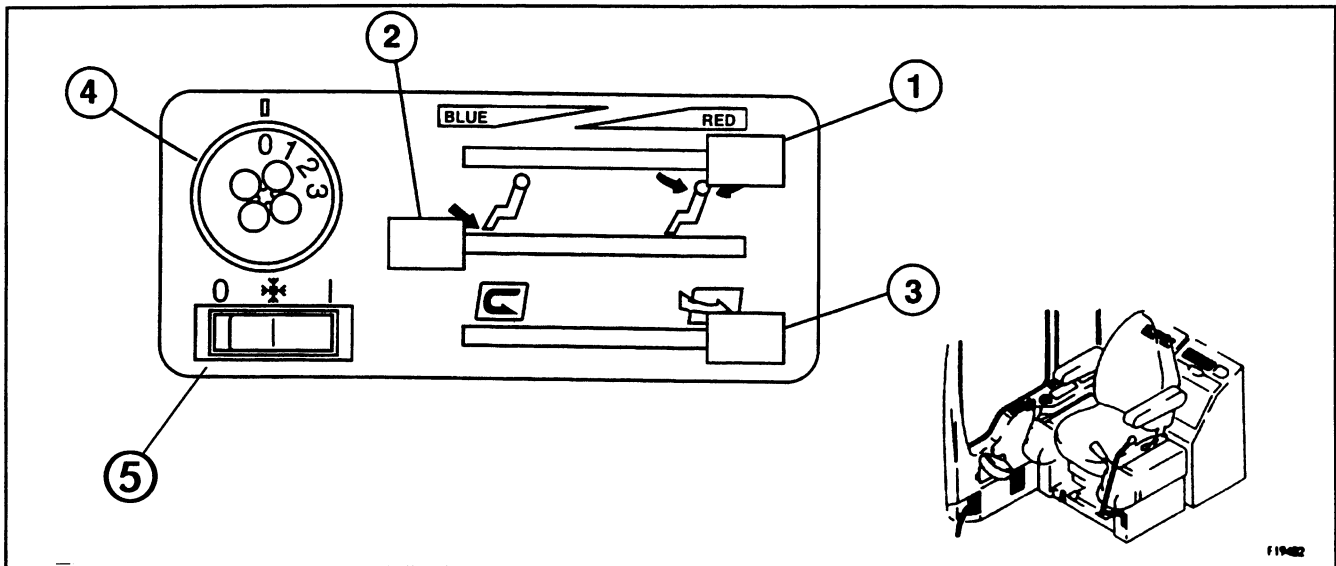

Description



The optional air conditioner can be used to cool, heat & de-humidify operators cab.

1. HEAT CONTROL SLIDER

By sliding control lever ① to the right (red) the air passing through the airconditioner unit will be warmed. In heating mode fresh ambient temperature air can be introduced to the cab when the lever ① is to the left (blue). In air conditioner mode temperature is controlled by adjusting lever ① to introduce some warm air to achieve desired temperature.

2. Outlet air distribution

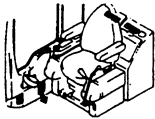
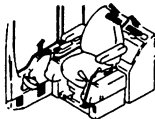

Outlet air can be distributed through various vents in the operators cab.

<p>Purpose</p>	<p>Sending air to lower area of operator's seat and defrosting lower part of front window</p>	<p>Sending air to upper area of operator's seat and defrosting upper part of front window</p>
<p>Lever position</p>		
<p>Air outlets</p>		

For complete defrosting of the front window, set the slider to the mid point of its stroke

3. Inlet air control slider

Changes between internal air recirculation & external fresh air intake.

<p>Purpose</p>	<p>Internal air circulation. This is used when wishing to quickly cool or warm the cab.</p>	<p>External air intake. This is used for fresh air intake or to remove condensation or ice on windows or when the air inside the cab is stale.</p>
<p>Lever position.</p>		

4. AIR FLOW SELECTOR SWITCH.

This switch adjust air flow in three steps.

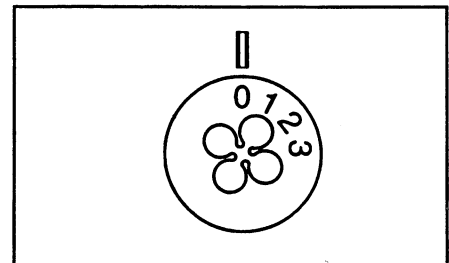

5. AIR CONDITIONER ON/OFF

This switch functions as an ON / OFF switch for the air conditioner system.

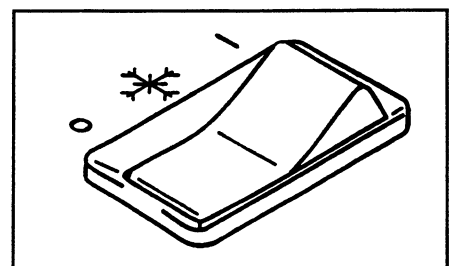

Notice

The fan selector switch ④ must be selected to position 1,2 or 3 before air conditioning can be operated.

11. EXPLANATION OF COMPONENTS

6. Defroster selector lever

This lever is used to remove condensation or ice from the lower part of front window during winter or rainy season.

Selector lever forward: defrost

Selector lever backwards: warms operator's feet

Defroster is available when air outlet slider is in the position shown by decal:

- Ⓐ Defroster
- Ⓑ Feet

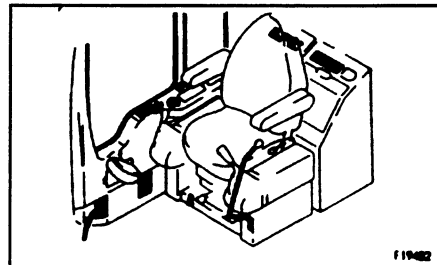
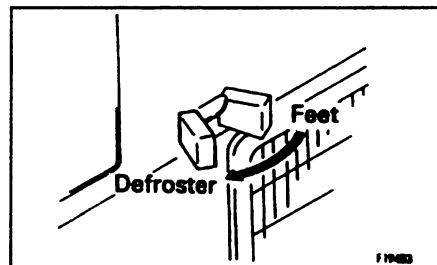

11.11.2 PRECAUTION WHEN USING AIR CONDITIONER

During cooling, ventilate the air from time to time.

- If operator is smoking during cooling, eyes may occasionally smart. In this case, temporarily change the switch to ventilation/cooling to exhaust the smoke.
- When cooling for a long time period, select ventilation/cooling once an hour.

Avoiding excessive cooling.

- If the operator feels somewhat cool when entering a cooled cab, the temperature (temperature difference between external temperature is 5° to 6°C(9°F to 11°F)) is at the optimum level from a health viewpoint. Adjust the cooling temperature carefully.

11.12 CAB RADIO (OPTION)

Refer to the separate operation manual for radio cassette.

Note

Ensure radio is switched off when leaving the machine for long periods to prevent draining of battery charge.

Antenna

If the reception is weak or generates noise, extend the antenna. If the reception is too strong, adjust the sensitivity by retracting the antenna.

NOTICE

When transporting the machine or parking it in a garage, always fully retract the antenna to avoid the possibility of breakage.

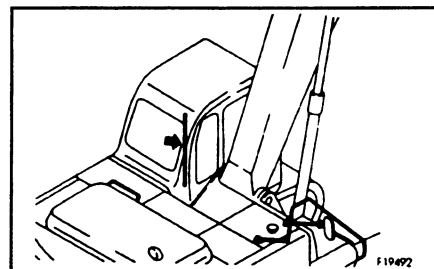

11.12.1 PRECAUTION OF USE

- To ensure safe operation, adjust the volume level so that external noise is still audible.
- Ensure no water is splashed over the speaker case or cab radio to prevent malfunction.
- Never use solution such as benzine or thinners to clean the dial or buttons. These should be wiped with a dry, soft cloth. (Use a cloth dipping in alcohol for very dirty surfaces.)
- At battery replacement, all the memory pre-set with the pre-set buttons will be cleared. Perform pre-setting again.

11. EXPLANATION OF COMPONENTS

11.13 FUSE

NOTICE

Before replacing a fuse, be sure to turn off the starting switch.

The fuses protect the electrical equipment and wiring from burning out.

If the fuse becomes corroded, or white powder can be seen, or the fuse is loose in the fuse holder, replace the fuse. Replace a fuse with another of the same capacity.

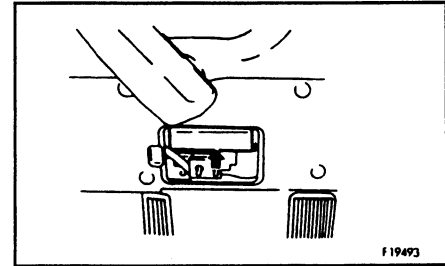

Fuse capacity and name of circuit

No	Fuse capacity	Name of circuit
①	10 A	Governor and pump controller
②	10 A	Solenoid valve
③	20 A	Air Conditioner (Motor)
④	20 A	Lamp (Deck left, deck right, boom left, boom right)
⑤	20 A	Cigar lighter, Air conditioner (control), Heater, Window washer, Left knob switch
⑥	10 A	Horn
⑦	15 A	Wiper motor controller
⑧	20 A	Lamp (Cab x 3), Beacon
⑩	20 A	Lower wiper, Refuelling pump, Travel Alarm
⑩	10 A	Key on signal
⑪	15 A	Lamp (Counterweight), Heated seat
⑫	10 A	Engine room lamp
⑬	10 A	Alarm buzzer, Monitor
⑭	20 A	Battery relay, Start signal
⑮	10 A	Roomlamp, Radio
⑯	10A	Spare fuse
⑰	10A	Spare fuse
⑱	10A	Spare fuse
⑲	10A	Spare fuse

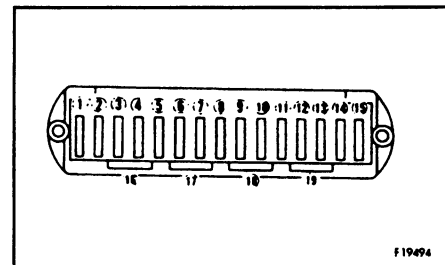

11.14 FUSIBLE LINK

If the starting motor will not rotate when the starting switch is turned ON, a possible cause is disconnection of wire-type fusible link ①. Open the battery room door on the left side of the machine body to inspect the fusible link and, if necessary, replace it.

REMARK

A fusible link refers to the large-sized fuse wiring installed in the high current flow portion of the circuit to protect electrical components and wiring from burning, similar to an ordinary fuse.

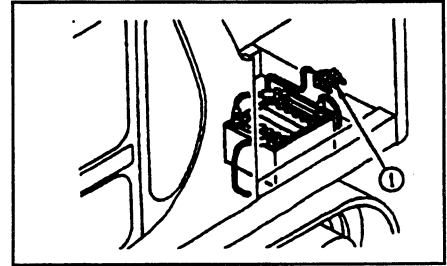

11.15 CONTROLLERS

A pump controller and governor controller are provided.

NOTICE

- Never splash or spill water, mud or drink over the controllers as this may cause a fault.
- If a fault occurs in the controller, do not attempt repair, but consult your Komatsu distributor.

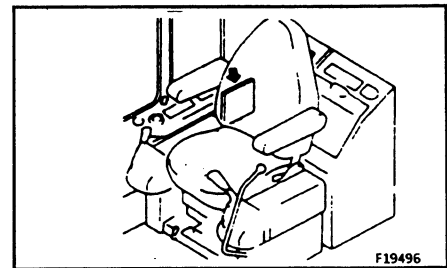

11.16 TOOL BOX

This is used for keeping the tools.

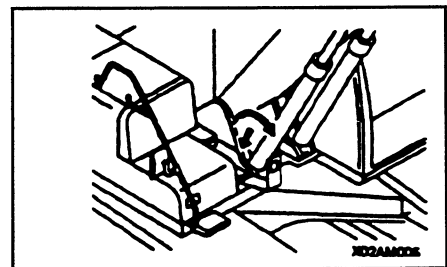

11.17 REFUELLING PUMP (Option)

⚠ WARNING

- Do not bring fire or sparks near the fuel.

1. When the machine is operated on sites with no fuel container and pump, the machine may be refuelled using the refuelling pump ① (if fitted) from fuel barrels.
The refuelling pump is located in the toolbox at the front right hand side of the machine.
2. Place the fuel hose ②, which is stored in tray ③ into the fuel barrel placed next to the machine.
3. Switch on refuelling pump using switch ④ on the pump assembly when adding fuel, never let the fuel overflow. This may cause fires.

Notes

- This pump is protected by fuse ⑤. If pump fails to function check fuse (10A).
- Ensure strainer on hose end is clean.

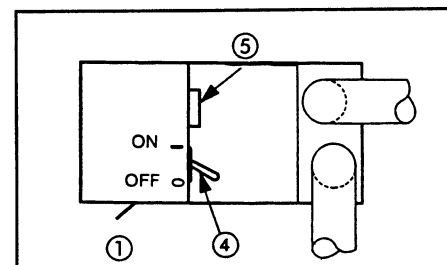
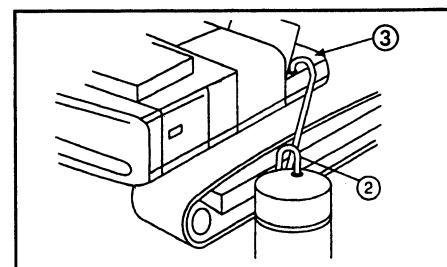

11.18 HANDLING THE ACCUMULATOR

⚠ WARNING

On machines equipped with an accumulator, for a short time after the engine is stopped, if the work equipment control lever is moved to the LOWER position, the work equipment will move down under its own weight.

After stopping the engine, always place the safety lock lever in the LOCK position and lock the attachment control pedal with the lock pin.

The accumulator is filled with high-pressure nitrogen gas, and it is extremely dangerous if it is handled in the wrong way. Always observe the following precautions.

- Never make any hole in the accumulator or expose it to flame or fire.
- Do not weld any boss to the accumulator.
- When disposing of the accumulator, it is necessary to release the gas from the accumulator, so please contact your Komatsu distributor.

This machine is equipped with the accumulator in the control circuit. The accumulator is a device to store the pressure in the control circuit, and when it is installed, the control circuit can be operated for a short time even after the engine is stopped. Therefore, if the control lever is moved in the direction to lower the work equipment, it is possible for the work equipment to move under its own weight.

The accumulator is installed to the position shown in the diagram on the right.

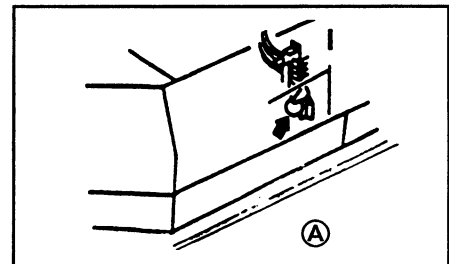

11.18.1 METHOD FOR RELEASING PRESSURE IN CONTROL CIRCUIT OF MACHINES EQUIPPED WITH ACCUMULATOR

1. Lower the work equipment to the ground. Close any attachment such as the crusher attachment jaws, etc.
2. Stop the engine.
3. Move the safety lock lever completely in the FREE position. Move the work equipment control lever and attachment control pedal full to the back and forth, right and left so as to release the pressure in the control circuit.
4. Move the safety lock lever to the lock position. Lock the control lever and attachment control pedal. The pressure, however, will not be completely released, so when the accumulator is removed in the control circuit, gradually loosen the screws. Never stand in the oil ejection direction.

12. OPERATION

12.1 CHECK BEFORE STARTING ENGINE

12.1.1 WALK-AROUND CHECK

WARNING

- **Dirt, oil or fuel around the parts of the engine which reach high temperatures may cause fire and damage to the machine. Check carefully, and if any abnormality is found, always repair it or contact your Komatsu distributor.**

Before starting the engine, look around the machine and under the machine to check for loose nut or bolts, or leakage of oil, fuel, or coolant, and check the condition of the work equipment and hydraulic system. Check also for loose wiring, play, and collection of dust at places which reach high temperatures.

Always carry out the items in this section before starting the engine each day.

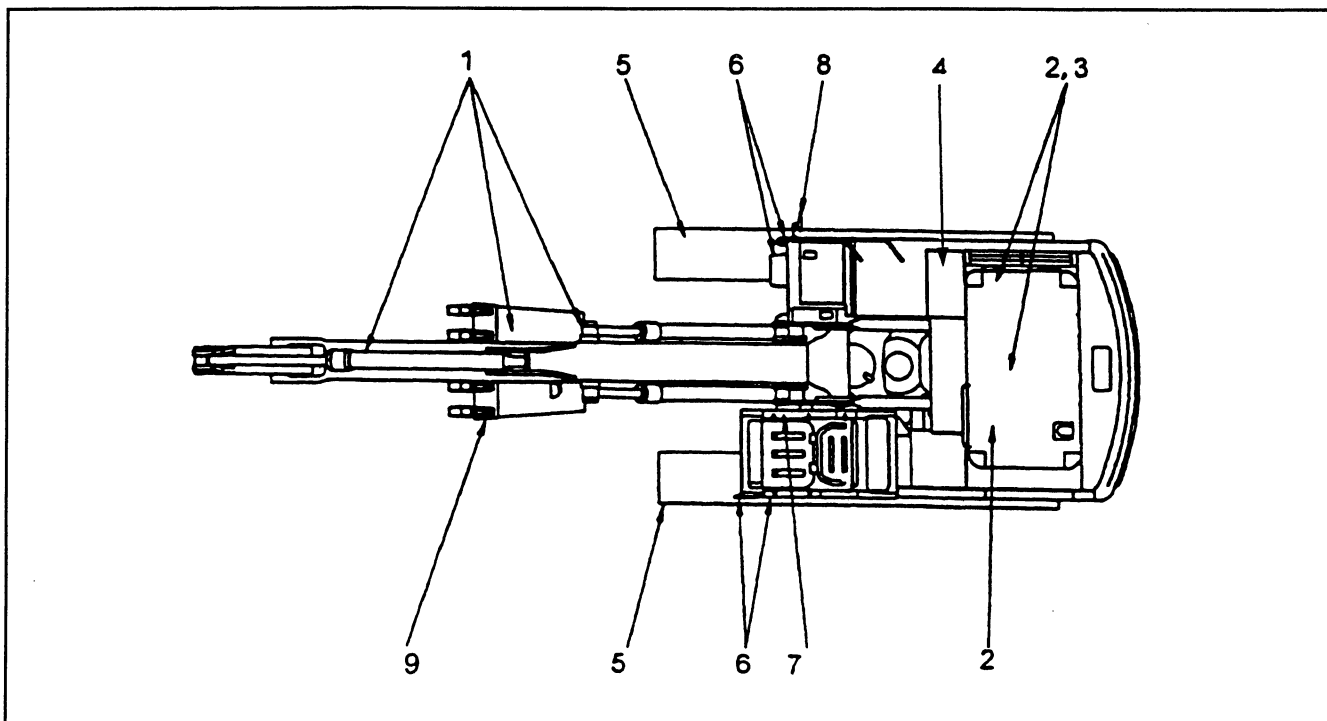

1. Check for damage, wear, play in work equipment, cylinders, linkage, hoses

Check that there are no cracks, excessive wear, or play in the work equipment, cylinders, linkage, or hoses. If any abnormality is found, repair it.

- 2. Remove dirt from around engine, radiator**
Check that there is no dirt accumulated around the engine or radiator. If any dirt is found, remove it.
- 3. Check for leakage of water or oil around engine**
Check that there is no leakage of oil from the engine or leakage of water from the cooling system. If any abnormality is found, repair it.
- 4. Check for oil leakage from hydraulic equipment, hydraulic tank, hoses, joints**
Check that there is no oil leakage. If any abnormality is found, repair the place where the oil is leaking.
- 5. Check the undercarriage (track, sprocket, idler, guard) for damage, wear, loose bolts or leaks of oil from rollers.**
- 6. Check for damage to handrail, loose bolts**
Repair any damage and tighten any loose.
- 7. Check for damage to gauges, monitor, loose bolts.**
Check that there is no damage to the gauges and monitor in the operator's cab. If any abnormality is found, replace the parts. Clean off any dirt on the surface.
- 8. Clean rear view mirror, check for damage**
Check that there is no damage to the rear view mirror. If it is damaged, replace it with a new mirror. Clean the surface of the mirror and adjust the angle so that the view to the rear can be seen from the operator's seat.
- 9. Check bucket with hook for damage**
Check the hook, catcher and hook foot for damage. If damage is found, contact your Komatsu distributor for repair.

12.1.2 CHECK BEFORE STARTING

Always carry out the items in this section before starting the engine each day.

CHECK COOLANT LEVEL, ADD WATER

⚠ WARNING

Do not open the radiator cap unless necessary. When checking the coolant, always check the radiator reserve tank when the engine is cold.

1. Open the rear door on the left side of the machine and check that the cooling water level is between the FULL and LOW marks on radiator reserve tank ② (shown in the diagram on the right). If the water level is low, add water through the water filler of reserve tank ② to the FULL level.
2. After adding water, tighten the cap securely.
3. If the reserve tank becomes empty, first inspect for water leaks and then fill the radiator and the reserve tank with water.

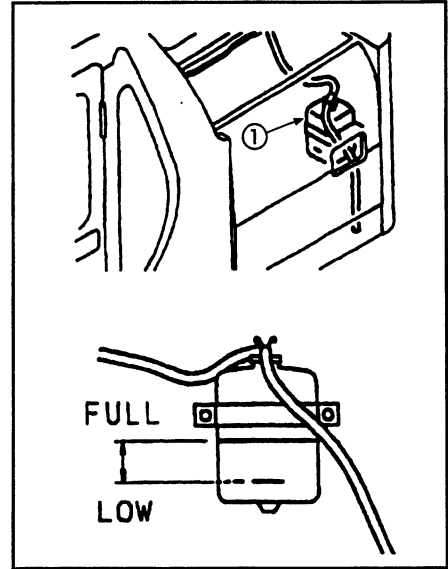

CHECK OIL LEVEL IN ENGINE OIL PAN, ADD OIL

1. Open the engine hood.
2. Remove dipstick ③ and wipe the oil off with a cloth.
3. Insert dipstick ③ fully in the oil filler pipe, then take it out again.
4. The oil level should be between the H and L marks on dipstick ③

If the oil level is below the L mark, add engine oil through oil filler ④. For details of the oil to use, see 20. "USE OF FUEL, COOLANT AND LUBRICANTS ACCORDING TO AMBIENT TEMPERATURE".

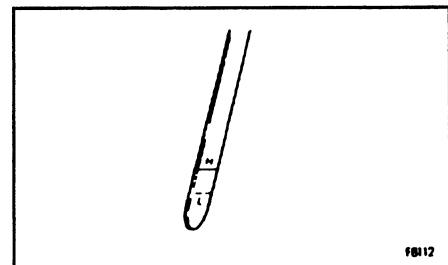
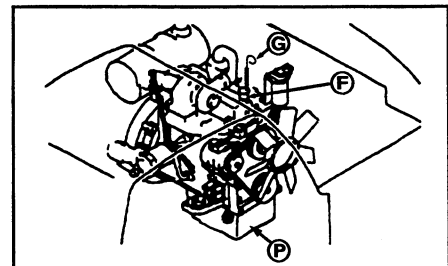

5. If the oil is above the H mark, drain the excess engine oil from drain plug ②, and check the oil level again.
6. If the oil level is correct, tighten the oil filler cap securely and close the engine hood.

REMARK

When checking the oil level after the engine has been operated, wait for at least 15 minutes after stopping the engine before checking. If the machine is at an angle, make it horizontal before checking.

CHECK FUEL LEVEL, ADD FUEL**WARNING**

When adding fuel, never let the fuel overflow. This may cause a fire. If spilling fuel, thoroughly clean up any spillage.

1. Open the pump room door on the right side of the machine and use sight gauge ③ of the rear face of the fuel tank to check that the tank is full.
2. If the fuel level is not within the sight gauge, add fuel through filler port ④ while watching sight gauge ③.

Fuel capacity: 240 ℓ (63.4 US gal, 52,8 UK gal)

For details of the fuel to use, see 20. "USE OF FUEL, COOLANT AND LUBRICANTS ACCORDING TO AMBIENT TEMPERATURE".

3. After adding fuel, tighten the cap securely.

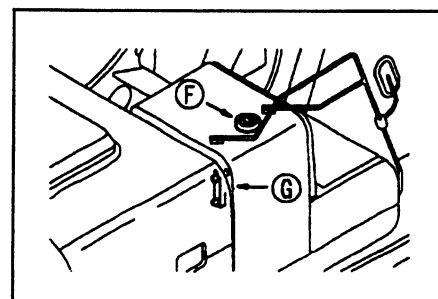
**REMARK**

If breather holes ① on the cap is clogged, the pressure in the tank will drop and fuel will not flow.

Clean the hole from time to time.

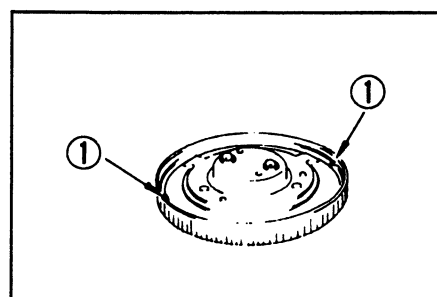

CHECK OIL LEVEL IN HYDRAULIC TANK, ADD OIL

WARNING

- When removing the oil filler cap, oil may spurt out, so turn the cap slowly to release the internal pressure before removing the cap.
- If oil has been added to above the H mark, stop the engine and wait for the hydraulic oil to cool down, then drain the excess oil from the drain plug .

1. If the work equipment is not in the condition shown in the diagram on the right, start the engine, run the engine at low speed, retract the arm and bucket cylinders, then lower the boom, set the bucket teeth in contact with the ground, and stop the engine.
2. Within 15 seconds after stopping the engine, move each control lever (for work equipment and travel) to the full stroke in all directions to release the internal pressure.
3. Open the pump room door on the right side of the machine. Check sight gauge . The oil level is normal if between the H and L marks.

NOTICE

Do not add oil if the level is above the H line. This will damage the hydraulic equipment and cause oil to spurt out.

4. If the level is below the L mark, remove the upper cover of the hydraulic tank and add oil through oil filler .

For details of the oil to use, see 20. "USE OF FUEL, COOLANT AND LUBRICANTS ACCORDING TO AMBIENT TEMPERATURE".

REMARK

The oil level will vary depending upon the oil temperature. Accordingly, use the following as a guide:

- Before operation: around L level
(Oil temperature 10 to 30°C (50 to 86°F))
- Normal operation: around H level
(Oil temperature 50 to 80°C (122 to 176°F))

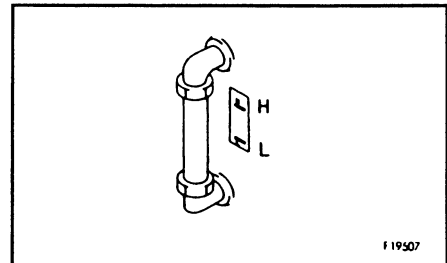
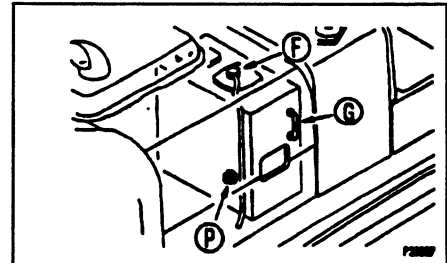
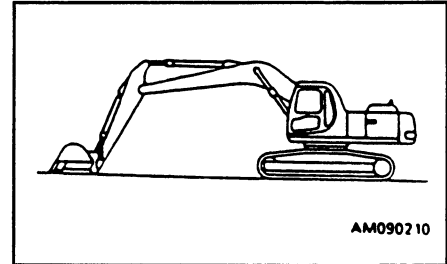

CHECK AIR CLEANER FOR CLOGGING

1. Confirm that the air cleaner clogging monitor does not flash
2. If it flashes, immediately clean or replace the element.

For details of the method of cleaning the element, see 24.2.1 "CHECK, CLEAN AND REPLACE AIR CLEANER ELEMENT".

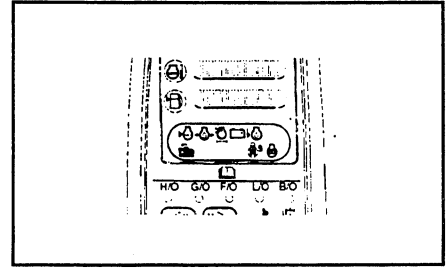
**CHECK ELECTRIC WIRING****WARNING**

If the fuse blows frequently, or there are traces of short-circuiting in the electric wiring, always locate and repair the cause.

Check for damage of the fuse and any sign of disconnection or short circuit in the electric wiring. Check also for loose terminals and tighten any loose parts. Check the following points carefully.

- Battery
- Starting motor
- Alternator

Please contact your Komatsu distributor for investigation and correction of the cause.

CHECK FOR WATER IN FUEL SEDIMENTOR

The fuel sedimentor is mounted in the pump compartment.

The water separator separates water mixed in the fuel. Before the water level reaches line (A), drain the water from drain plug (P). For the draining procedure, see section "WHEN REQUIRED".

- Even if a water separator is installed, be sure to check the fuel tank to remove water and sediment in the fuel.

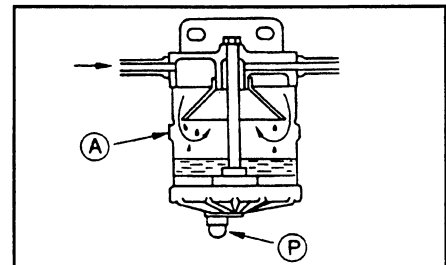
**CHECK FOR WATER IN PRIMARY FUEL FILTER, DRAIN WATER**

A primary fuel filter is fitted on the engine

1. With the engine off open the engine cover and locate the water drain at the bottom of the primary fuel filter.
2. To open drain valve, turn the valve counterclockwise approximately 1,5 to 2 turns until draining occurs. Drain the filter sump of water until clear fuel is visible.
3. Turn the valve clockwise to close.

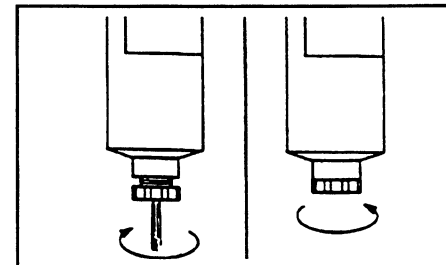
**NOTICE:**

Do not over tighten the valve. Over tightening can damage the threads.

12.1.3 ADJUSTMENT BEFORE OPERATION OPERATOR'S SEAT

(A) Fore-and-aft adjustment of seat

Pull lever ① up. After the seat is set to the desired position, release the lever.

Adjustable distance: 160 mm

(B) Adjustment of reclining seat

Pull lever ② up. After the seat back is set to the optimum position for easy operation, release the lever.

(C) Adjustment of seat tilting angle

1. Forward tilting

Pull lever ③ up to release locking. After the seat is set to the optimum position for easy operation, release the lever to lock it.

2. Backward tilting

Push lever ③ down to release locking. After the seat is set to the optimum position for easy operation, release the lever to lock it.

3. Seat height adjustment

By a combination of step 1 and 2, the seat can be moved up and down. After the desired height is set by forward/backup tilting, bring the seat to the horizontal position by reverse-tilting and fix it.

Adjustable height: 60 mm (2.4 in)

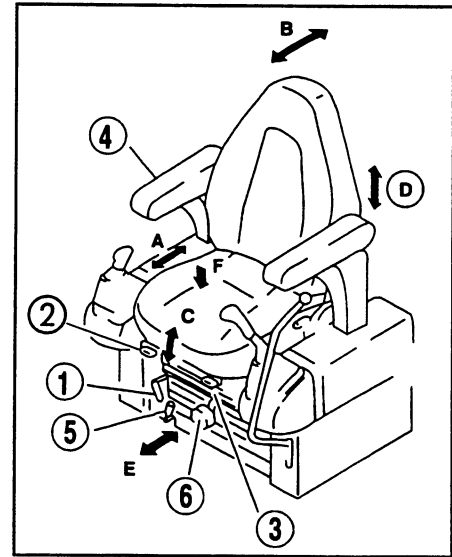

(D) Armrest height adjustment

Armrest ④ can be raised and lowered by loosening the bolts in the rear of the armrest columns, adjusting the height and retightening the bolts

(E) Fore-and-aft adjustment of whole seat

After lever ⑤ is pulled up and the seat is set to the desired position, release the lever. In this case the operator's seat, left and right levers and safety lock lever will slide together. Adjustable fore-and-aft movement: 120 mm (4.7 in)

(F) Suspension adjustment

When knob ⑥ is turned clockwise, the suspension becomes harder and when turned counterclockwise, softer. Adjust the dial so that the suspension best matching the operator's weight is selected. Adjustable range: 50 to 120 kg (110 to 265 lb)

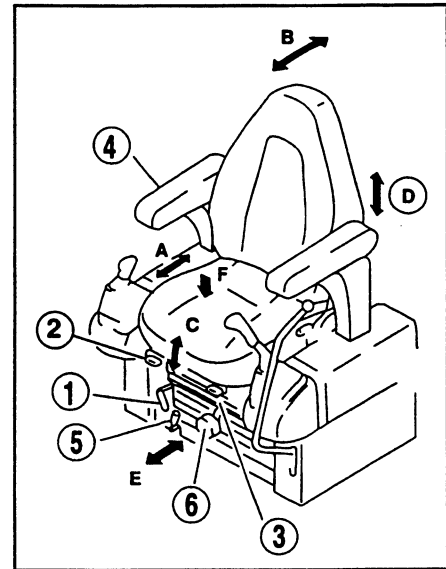
**ADJUSTMENT OF MONITOR PANEL ANGLE**

Turn the monitor panel so that the operator can view the monitor with ease. When adjusting the angle, the panel should be set to the desired position using both hands. The panel is automatically locked at that position.

Amount of adjustment: 30° (stepless)

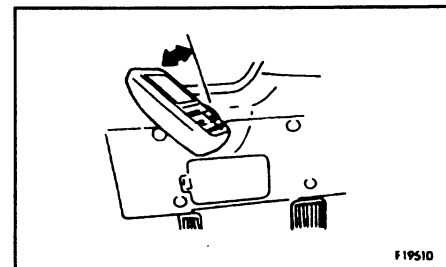

12.1.4 OPERATIONS AND CHECKS BEFORE STARTING ENGINE

WARNING

If the control lever is touched by accident, the work equipment or the machine may move suddenly. When leaving the operator's compartment, always set the safety lock lever securely to the LOCK position.

1. Check that safety lock lever ① is at the LOCK position.
2. Check the position of each lever.

Set the control lever to the neutral position.
When starting the engine, never touch the knob button.

3. Insert the key in starting switch ②, turn the key to the ON position, then carry out the following checks.

The buzzer will sound for approx. 1 sec, and the following monitors and gauges will light up for approx. 3 sec.

- Radiator water level monitor ③
- Engine oil level monitor ④
- Charge level monitor ⑤
- Fuel level monitor ⑥
- Engine water temperature monitor ⑦
- Engine oil pressure monitor ⑧
- Engine water temperature gauge ⑨
- Fuel gauge ⑩
- Engine pre-heating monitor ⑪
- Air cleaner clogging monitor ⑫
- Swing lock monitor ⑬

If the monitors or gauges do not light up or the buzzer does not sound, there is probably a broken bulb or disconnection in the monitor wiring, so contact your Komatsu distributor for repairs.

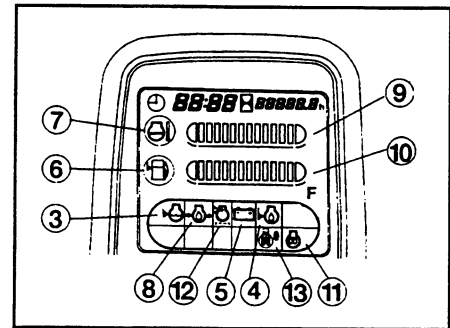
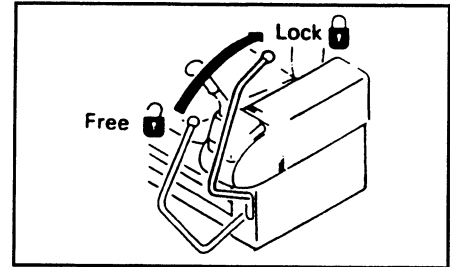
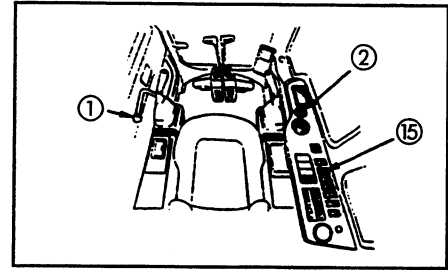

After approx. 3 sec, the following gauges will remain on and the other monitors will go out.

- Engine water temperature gauge ⑨
- Fuel gauge ⑩

- (2) Press lamp switch ⑮ to turn on the head lamps.
If the lamp switch do not light up, there is probably a broken bulb or disconnection in the wiring, so contact your Komatsu distributor for repairs.

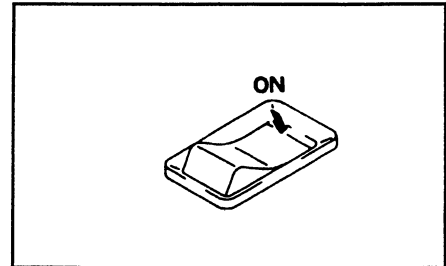

12.2 STARTING ENGINE

12.2.1 NORMAL STARTING

WARNING

Check that there are no persons or obstacles in the surrounding area, then sound the horn and start the engine.

NOTICE

Do not keep the starting motor rotating continuously for more than 20 seconds.

If the engine will not start, wait for at least 2 minutes before trying to start the engine again.

1. Set fuel control dial ① at the low idling (MIN) position.

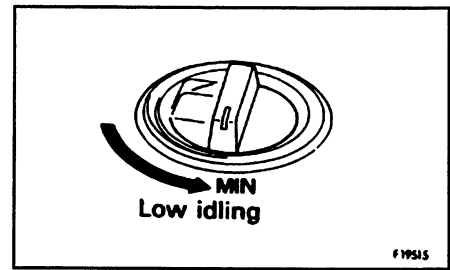
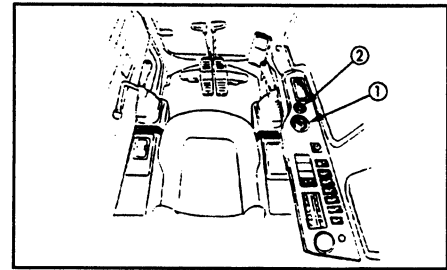

2. Turn the key in starting switch ② to the START position. The engine will start.

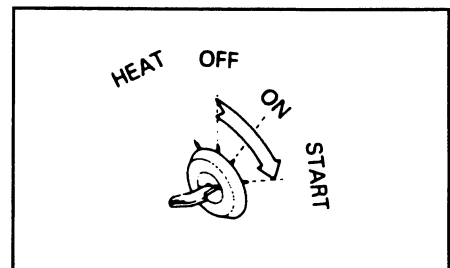

3. When the engine starts, release the key in starting switch ②. The key will return automatically to the ON position.

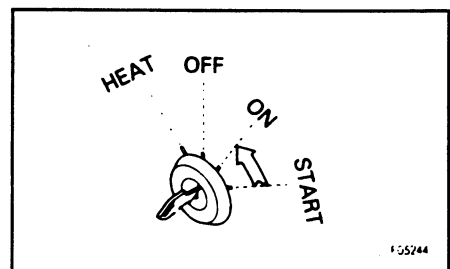

12.2.2 STARTING IN COLD WEATHER

⚠ WARNING

- Check that there are no persons or obstacles in the surrounding area, then sound the horn and start the engine.
- Never use starting aid fluids as they may cause explosions.

NOTICE

Do not keep the starting motor rotating continuously for more than 20 seconds.

If the engine fails to start, repeat from step 2 and after waiting for about 2 minutes.

When starting in low temperatures, do as follows.

1. Set fuel control dial ① at the low idling (MIN) position.
2. Hold the key in starting switch ② at the HEAT position, and check that preheating monitor ③ lights up.
After about 30 seconds, preheating monitor lamp ③ will flash for about 10 seconds to indicate that preheating is finished.

REMARK

The monitor and gauge also light up when the key is at the HEAT position, but this does not indicate any abnormality.

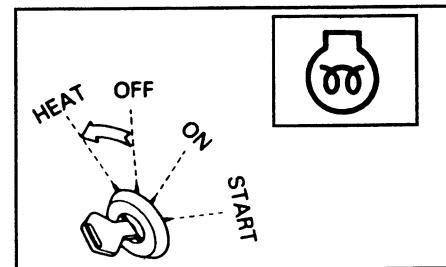
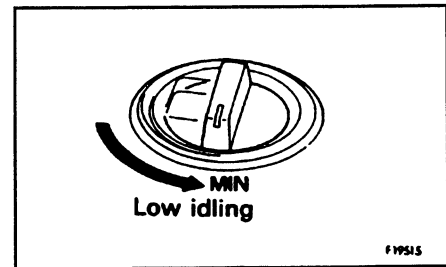
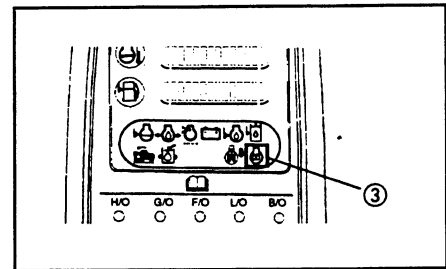
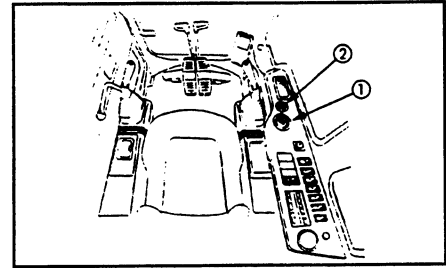

12. OPERATION

3. When preheating monitor ③ flashes, turn the key in starting switch ② to the START position to start the engine.

Ambient temperature	Preheating time
Above 0°C	-
0°C to -10°C	20 seconds
-10°C to -20°C	30 seconds

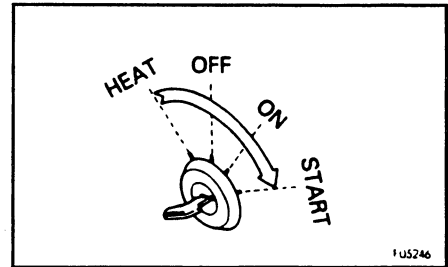

4. When the engine starts, release the key in starting switch ②. The key will return automatically to the ON position.

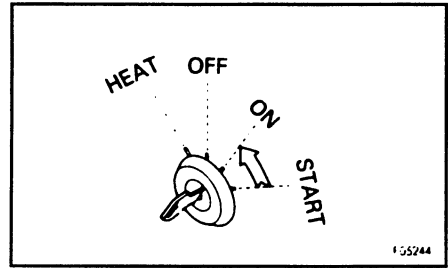

12.3 OPERATIONS AND CHECKS AFTER STARTING ENGINE

WARNING

- **Emergency stop**
If there has been any abnormal actuation or trouble, turn the starting switch key to the OFF position.
- If the work equipment is operated without warming the machine up sufficiently, the response of the work equipment to the movement of the control lever will be slow, and the work equipment may not move as the operator desires, so always carry out the warming-up operation. Particularly in cold areas, be sure to carry out the warming-up operation fully.

12.3.1 WHEN NORMAL

NOTICE

- When the hydraulic oil is at a low temperature, do not carry out operations or move the levers suddenly. Always carry out the warming-up operation. This will help to extend the machine life. Do not suddenly accelerate the engine before the warming-up operation is completed.
- Do not run the engine at low idling or high idling continuously for more than 20 minutes. This will cause leakage of oil from the turbocharger oil supply piping.
If it is necessary to run the engine at idling, apply a load from time to time or run the engine at a mid-range speed.

After starting the engine, do not immediately start operations. First, carry out the following operations and checks.

1. Turn fuel control dial ① to the center position between LOW IDLING (MIN) and HIGH IDLING (MAX) and run the engine at medium speed for about 5 minutes with no load.
2. While running the engine at medium speed, press working mode switch ② until the heavy-duty operation mode lamp is turned on.

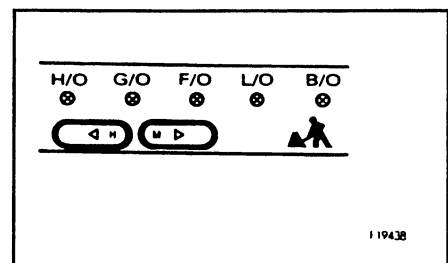
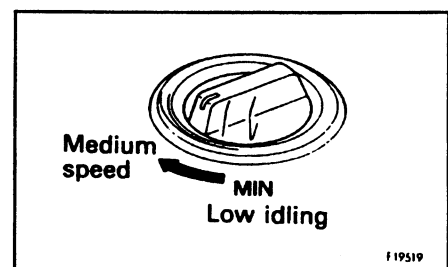
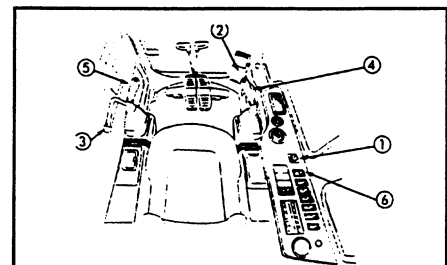

12. OPERATION

3. Set the safety lock lever ③ to the FREE position, and raise the bucket from the ground.

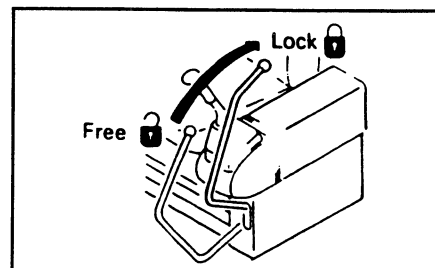

4. Operate bucket control lever ④ and arm control lever ⑤ slowly to move the bucket cylinder and arm cylinder to the end of the stroke.

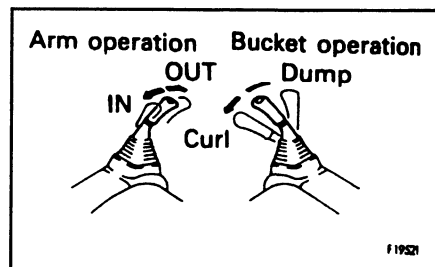

5. Carry out bucket and arm operation for 5 minutes at full stroke, alternating between bucket operation and arm operation at 30 second intervals.

If the swing lock switch ⑥ is set to the ON (actuated) position and swing control lever ⑤ is operated at full stroke, oil temperature rise can be increased earlier.

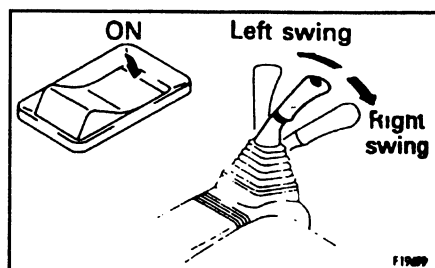

NOTICE

When the work equipment is retracted, take care that it does not interfere with the machine body or ground.

6. After carrying out the warming-up operation, check that each gauge and monitor lamp is in the following condition.

- Engine water temperature gauge ⑦: Inside green range
- Fuel gauge ⑧: Inside green range
- Engine water temperature monitor ⑨: OUT
- Radiator water level monitor ⑩: OUT
- Engine oil pressure monitor ⑪: OUT
- Charge level monitor ⑫: OUT
- Fuel level monitor ⑬: OUT
- Air cleaner clogging monitor ⑭: OUT
- Engine pre-heating monitor ⑮: OUT
- Engine oil level monitor ⑯: OUT

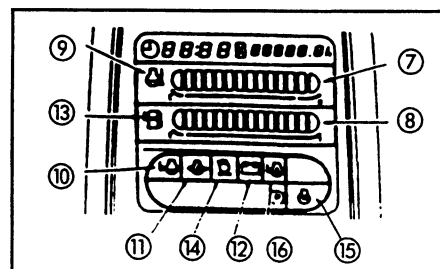

7. Check that there is no abnormal exhaust gas colour, noise, or vibration. If any abnormality is found, repair it.

8. Press working mode switch ② on the monitor panel until the lamp of the mode to be used lights up.

12.3.2 IN COLD AREAS (AUTOMATIC WARMING-UP OPERATION)

When starting the engine in cold areas, carry out the automatic warming-up operation after starting the engine.

When the engine is started, if the engine water temperature is low (below 30°C (86°F)), the warming-up operation is carried out automatically.

The automatic warming-up operation is cancelled if the engine water temperature reaches the specified temperature (30°C (86°F)) or if the warming-up operation is continued for 10 minutes. If the engine water temperature or hydraulic oil temperature are low after the automatic warming-up operation, warm the engine up further as follows.

NOTICE

- **When the hydraulic oil is at a low temperature, do not carry out operations or move the levers suddenly. Always carry out the warming-up operation. This will help to extend the machine life.**
 - **Do not suddenly accelerate the engine before the warming-up operation is completed.**
- Do not run the engine at low idling or high idling continuously for more than 20 minutes. This will cause leakage of oil from the turbocharger oil supply piping. If it is necessary to run the engine at idling, apply a load from time to time or run the engine at a mid-range speed.**

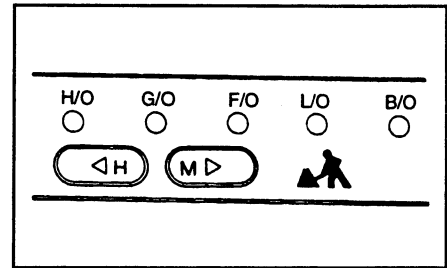

1. Set fuel control dial ① at the low idling (MIN) position and run the engine for about 5 minutes without load.

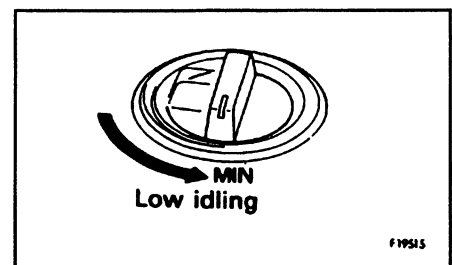
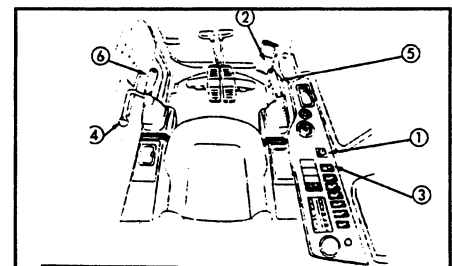

12. OPERATION

- Press working mode switch ② on the monitor panel until H.O (heavy duty operation) mode lamp lights up.

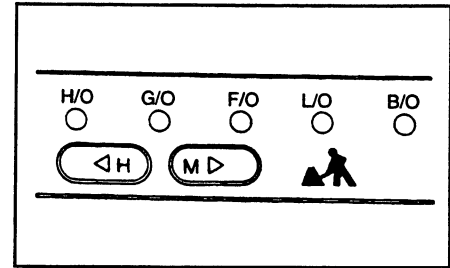

- Turn fuel control dial ① to the mid-range speed position.

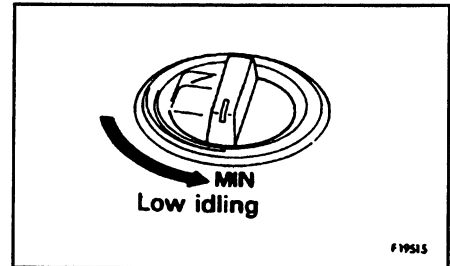

- Set safety lock lever ④ to the FREE position and raise the bucket from the ground.

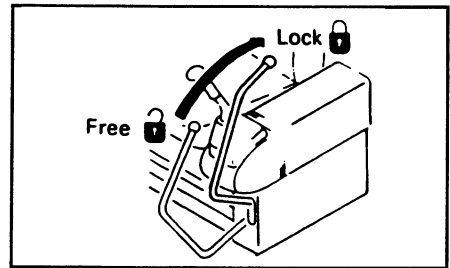

- Operate bucket control lever ⑤ and arm control lever ⑥ slowly to move the bucket cylinder and arm cylinder to the end of their stroke.
- Operate the bucket for 30 seconds and the arm for 30 seconds in turn fully for 5 minutes.

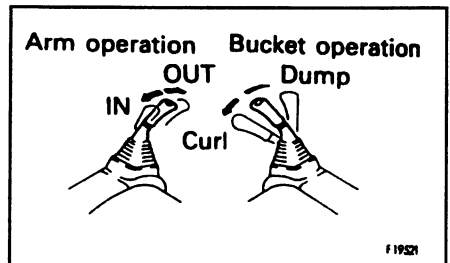

REMARK

Turn swing lock switch ③ ON (ACTUATED) and operate the lever to make the oil temperature rise more quickly.

NOTICE

When the work equipment is retracted, take care that it does not interfere with the machine body or ground.

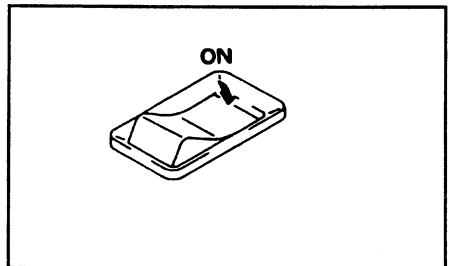

7. Turn fuel control dial ① to the full speed (MAX) position and carry out the operation in Step 6 for 3 - 5 minutes.
8. Repeat the following operation 3 - 5 times and operate slowly.
 - Boom operation RAISE ↔ LOWER
 - Arm operation IN ↔ OUT
 - Bucket operation CURL ↔ DUMP
 - Swing operation LEFT ↔ RIGHT
 - Travel (Lo) operation FORWARD ↔ REVERSE

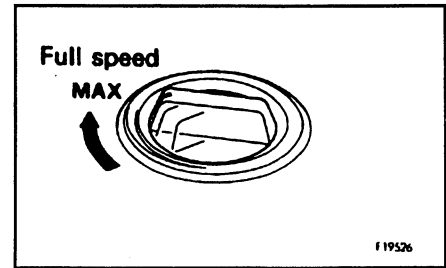

REMARK

If the above operation is not carried out, there may be a delay in response when starting or stopping each actuator, so continue the operation until it becomes normal.

9. Use working mode switch ② on the monitor panel to switch to the working mode to be used.

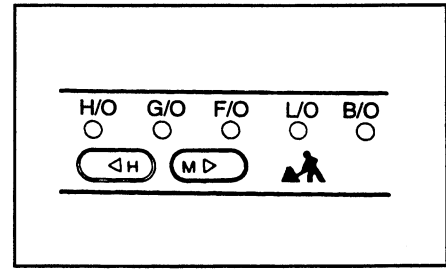

NOTICE

Cancelling automatic warming-up operation

If it becomes necessary in an emergency to lower the engine speed to low idling, cancel the automatic warming-up operation as follows.

1. Turn fuel control dial ① to the full speed (MAX) position and hold it for 3 seconds.

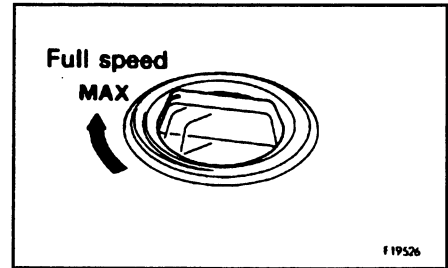

2. When fuel control dial ① is returned to the low idling (MIN) position, the engine speed will drop.

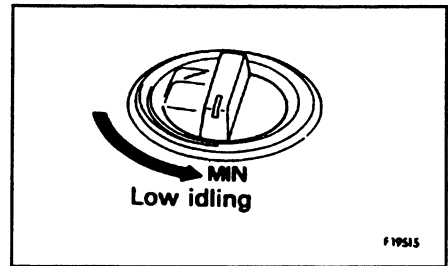

12.4 MOVING MACHINE OFF

12.4.1 MOVING MACHINE FORWARD

WARNING

- Before operating the travel levers, check the direction of the track frame. If the sprocket is at front, the operation of the track levers is reversed.
- When moving off, check that the area around the machine is safe, and sound the horn before moving.
- Clear all personnel from the machine and the area.
- Clear all obstacles from the path of the machine.
- If the lever is moved inside the deceleration range, engine speed will rise suddenly. Operate the levers carefully.

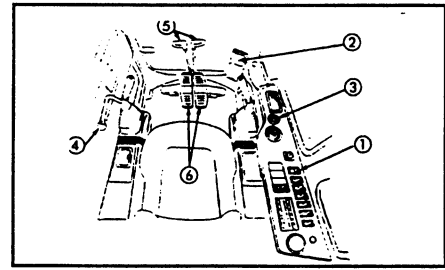

1. Set swing lock switch ① to the ON (actuated) position and confirm that swing lock monitor lamp ② lights up.

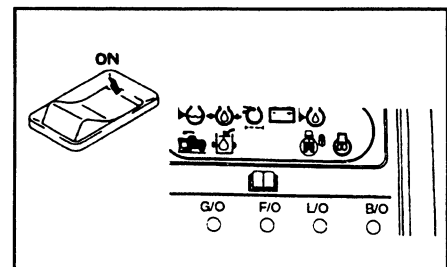

2. Turn fuel control dial ③ towards the full speed position to increase the engine speed.

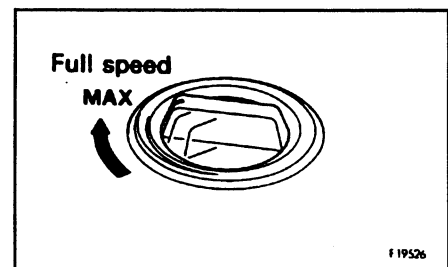

3. Set safety lock lever ④ in the FREE position, fold the work equipment, and raise it 40 - 50 cm (16 to 20 in) from the ground.

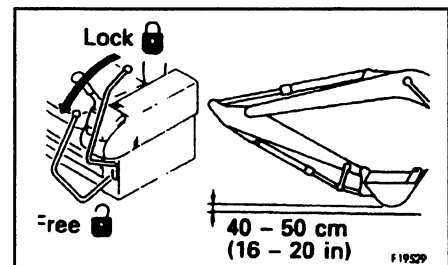

12. OPERATION

4. Operate right and left travel levers ⑤ or right and left travel pedals ⑥ as follows.

- When the sprocket is at the rear of the machine.
Push levers ⑤ forward slowly or depress the front part of pedals ⑥ slowly to move the machine off.

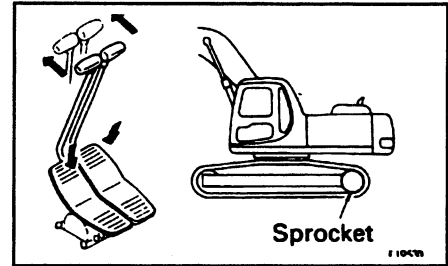

- When the sprocket is at the front of the machine.
Pull levers ⑤ backward slowly or depress the rear part of pedals ⑥ slowly to move the machine off.

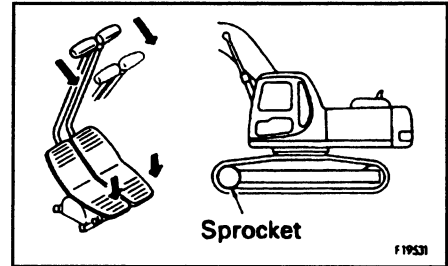

REMARK

Each time the travel levers are operated on machines equipped with the travel alarm, the alarm sounds to warn people in the machine vicinity.

12.4.2 MOVING MACHINE BACKWARD

WARNING

- Before operating the travel levers, check the direction of the track frame. If the sprocket is at front, the operation of the track levers is reversed.
- When moving off, check that the area around the machine is safe, and sound the horn before moving.
- Clear all personnel from the machine and the area.
- Clear all obstacles from the path of the machine.
- Use extreme care when reversing the machine. Note there is a blind spot behind the machine.
- If the lever is moved inside the deceleration range, engine speed will rise suddenly. Operate the levers carefully.

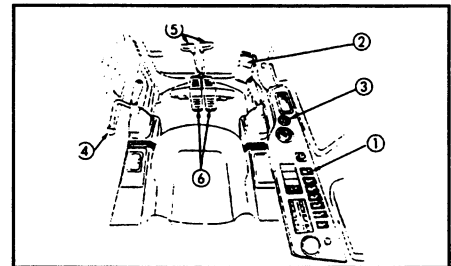

1. Set swing lock switch ① to the ON (actuated) position and confirm that swing lock monitor lamp ② lights up.

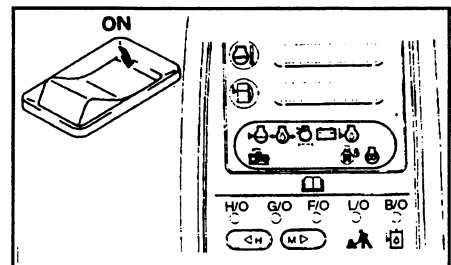

2. Turn fuel control dial ③ towards the full speed (MAX) position to increase the engine speed.

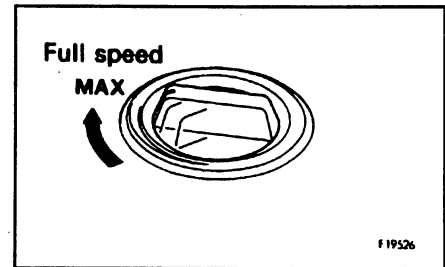

3. Set safety lock lever ④ in the FREE position, fold the work equipment, and raise it 40 - 50 cm (16 to 20 in) from the ground.

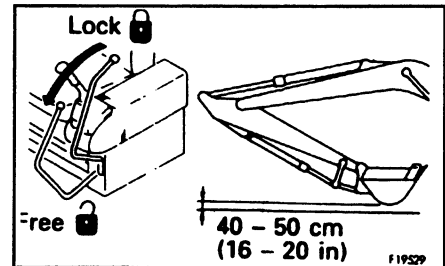

4. Operate right and left travel levers ⑤ or right and left travel pedals ⑥ as follows.

- **When the sprocket is at the rear of the machine**

Pull levers ⑤ backward slowly or depress the rear part of pedals ⑥ slowly to move the machine off.

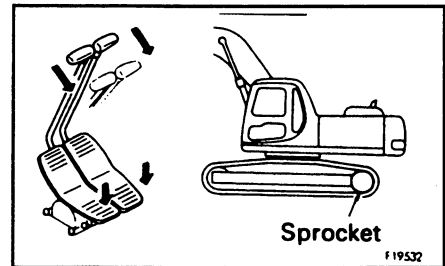

- **When the sprocket is at the front of the machine**

Push levers ⑤ forward slowly or depress the front part of pedals ⑥ slowly to move the machine off.

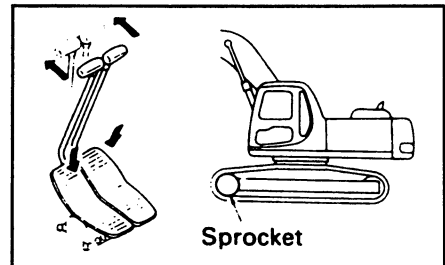

12.5 STEERING MACHINE

12.5.1 STEERING (changing direction)

WARNING

Before operating the travel levers, check the position of the sprocket. If the sprocket is at the front, the operation of the travel levers is reversed.

Use the travel levers to change direction.

Avoid sudden changes of direction as far as possible. In particular, when carrying out counter-rotation (spin turn), stop the machine first before turning.

Operate two travel levers ① as follows.

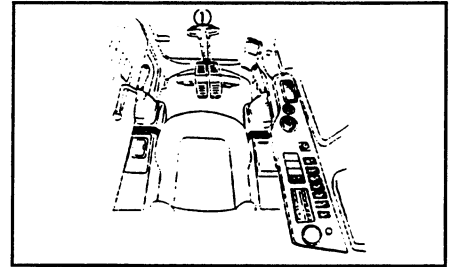

Changing direction of machine when stopped

When turning to the left:

Push the right travel lever forward to travel left when travelling forward; and pull it back to turn left when travelling in reverse.

REMARK

When turning to the right, operate the left travel lever in the same way.

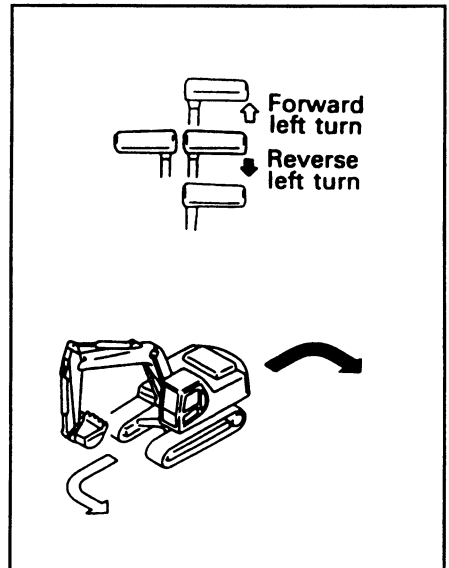

Steering when travelling (left and right travel levers both operated in same direction)

When turning to the left:

If the left travel lever is returned to the neutral position, the machine will turn to the left.

REMARK

When turning to the right, operate the right travel lever in the same way.

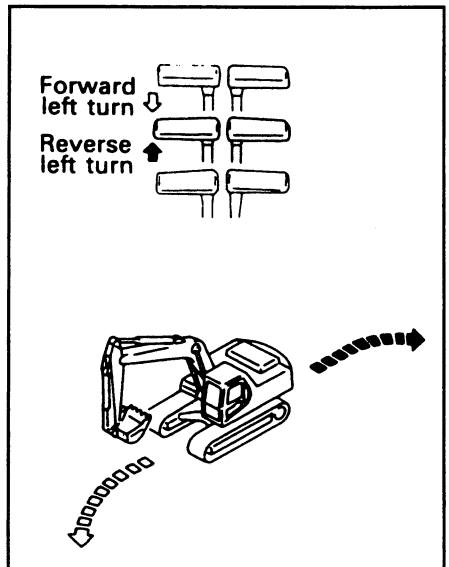

When making counter-rotation turn (spin turn)

When turning left using counter-rotation, pull the left travel lever back and push the right travel lever forward.

REMARK

When turning to the right using counter-rotation, pull the right travel lever back and push the left travel lever forward.

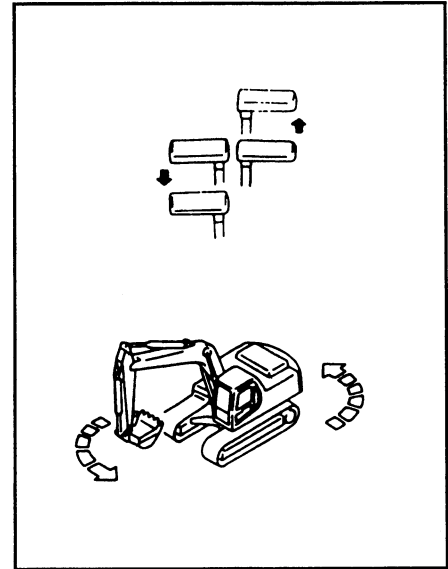

12.6 STOPPING MACHINE

⚠ WARNING

- Avoid stopping suddenly. Give yourself ample room when stopping.
- When stopping the machine, select flat hard ground and avoid dangerous places. If it is unavoidably necessary to park the machine on a slope, insert blocks underneath the track shoes. As an additional safety measure, thrust the bucket into the ground.
- If the control lever is touched by accident, the work equipment or the machine may move suddenly, and this may lead to a serious accident. Before leaving the operator's compartment, always set the safety lock lever securely to the LOCK position.

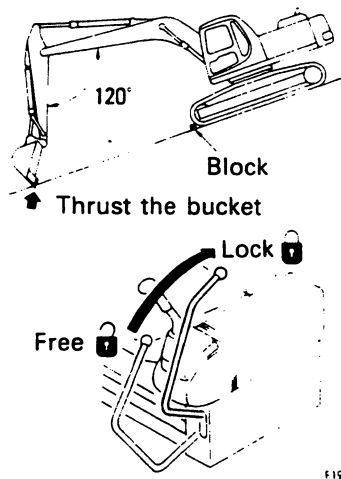

1. Put the left and right travel levers ① in the neutral position, then stop the machine.

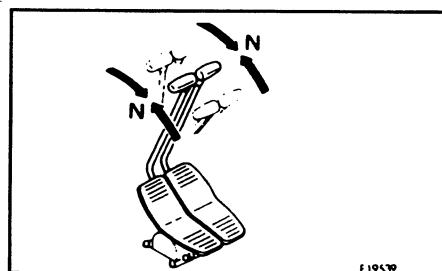
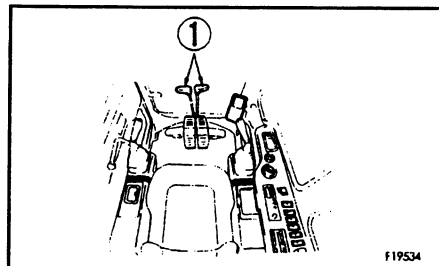

12.7 SWINGING

WARNING

When operating the swing, check that the area around the machine is safe.

1. Before operating the swing, turn swing lock switch ① OFF (CANCELLED).

NOTICE

Check that swing lock lamp ② goes out at the same time.

2. Operate the left work equipment control lever ③ to swing the upper structure.

3. When not operating the swing, turn the swing lock switch ① ON (ACTUATED).

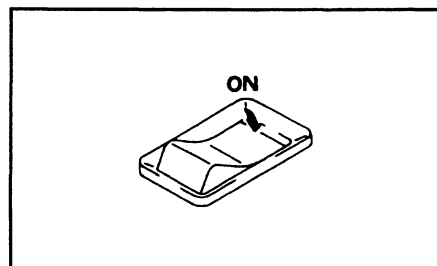
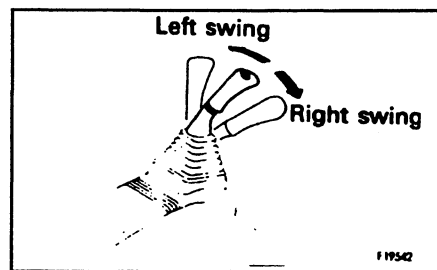
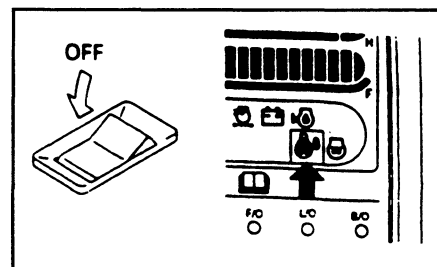
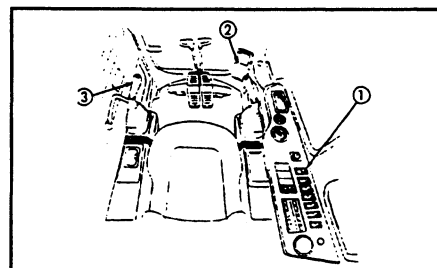

12.8 OPERATION OF WORK EQUIPMENT

⚠ WARNING

If any lever is operated when in the deceleration range, the engine speed will suddenly increase, so be careful when operating the levers.

The work equipment is operated by the left and right work equipment control levers. The left work equipment control lever operates the arm and swing, and the right work equipment control lever operates the boom and bucket.

The movements of the lever and work equipment are as shown in the diagrams on the right. When the levers are released, they automatically return to the neutral position and the work equipment is held in place.

- If the work equipment control lever is returned to the neutral position when the machine is stopped, even if the fuel control dial is set to FULL, the auto-deceleration mechanism will act to reduce the engine speed to a mid-range speed.

REMARK

If the levers are operated within 15 seconds after stopping the engine, it is possible to lower the work equipment to the ground.

In addition, the levers can also be operated to release any remaining pressure inside the hydraulic cylinder circuit and to lower the boom after the machine on a trailer.

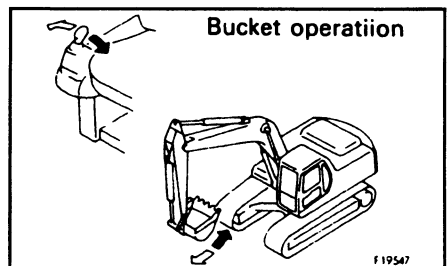
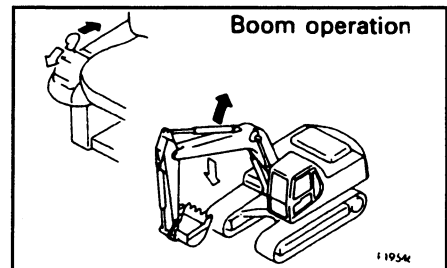
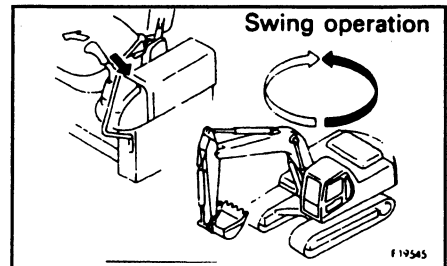
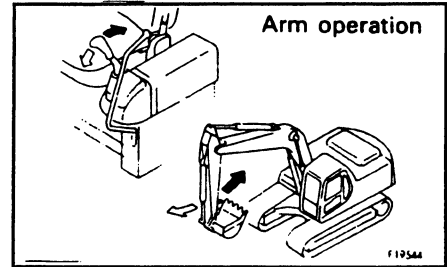

12.9 WORKING MODE SELECTION

WORKING MODE

The mode selector switches can be used to switch the mode to match the conditions and purpose of work, thereby enabling efficient operation.

Use the following procedures to make the most effective use of each mode.

When the starting switch is turned ON, the working mode is set to general operation mode (G.O.), so normal work can be carried out without needing to set the mode.

Set the most effective mode according to the type of work using working mode selector switch.

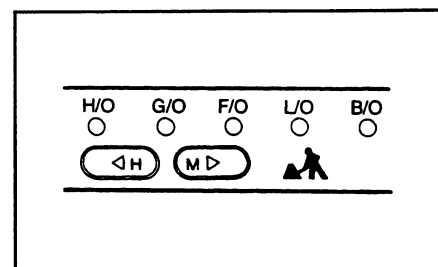

Working mode	Applicable work	Power max. (power up)	Swift slow-down (speed down)
		Power	Speed
Heavy-duty operation mode (H.O.)	Large amount of digging and loading in a short time	5% up	Approx 20% down
General operation mode (G.O.)	Normal digging and loading operation	10% up	Approx 10% down
Finishing operation mode (F.O.)	Finishing, levelling and general hauling operation	-	-
Lifting operation mode (L.O.)	Positioning, etc.	-	-
Breaker operation mode (B.O.)	Breaker operation	-	-

NOTICE

Never carry out breaker operation in heavy-duty operation mode (H.O.) as this may result in breakage of hydraulic equipment.

12. OPERATION

POWER MAX./SWIFT SLOW-DOWN

During operation, power up/speed down of work equipment can be performed by one-touch. Use this function effectively in combination with working mode.

1. When starting switch is turned ON, the power up lamp turns on. When SET switch is pressed once, the speed down lamp turns on and the power up lamp goes out, and when pressed again, the opposite occurs.

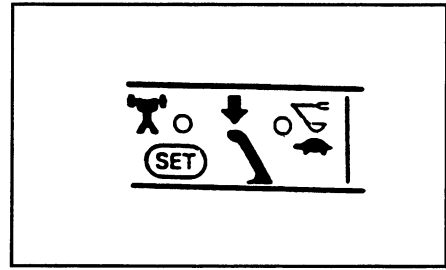
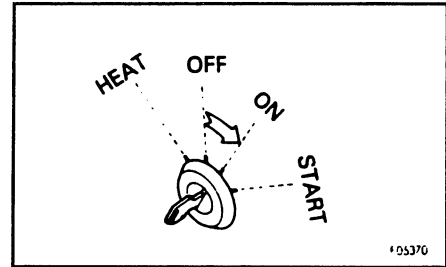

2. When the left knob button is given a single click (keep depressed after initially pressing) power keeps increasing while depressed. However, power up automatically completes after 8.5 seconds.

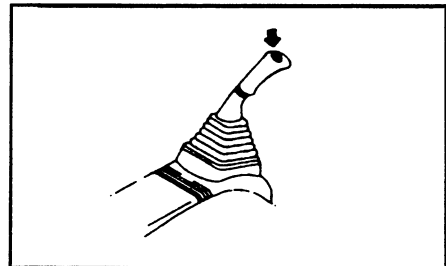

12.10 PROHIBITIONS FOR OPERATION

WARNING

- If it is necessary to operate the work equipment control lever when the machine is travelling, stop the machine before operating the work equipment control lever.
- If the lever is moved inside the deceleration range, engine speed will suddenly rise. Operate the levers carefully.
- Never operate the machine on a rock bed (hard or soft rock).

Prohibited operations using swing force

Do not use the swing force to compact soil or break earth mounds or walls.

When swinging, do not dig the bucket teeth into the soil. These operations will damage the work equipment.

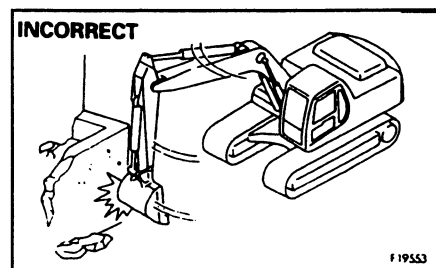

Prohibited operations using travel force

Do not leave the bucket dug into the ground and use the travel force to excavate. This will bring excessive force to bear on the rear of the machine.

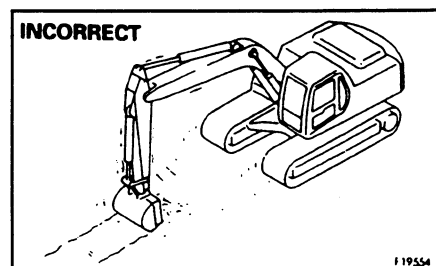

Precautions when operating hydraulic cylinders to end of stroke

If the cylinder is operated to the end of its stroke during operations, force will be brought to bear on the stopper inside the cylinder, and this will reduce the life of the machine. To prevent this, always leave a small safety margin when operating the cylinders.

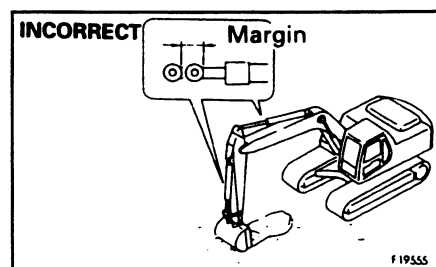

Prohibited operations using dropping force of bucket

Do not use the dropping force of the bucket as a pickaxe, breaker, or pile driver. This will bring excessive force to bear on the rear of the machine, and will not only damage the machine, but is also dangerous.

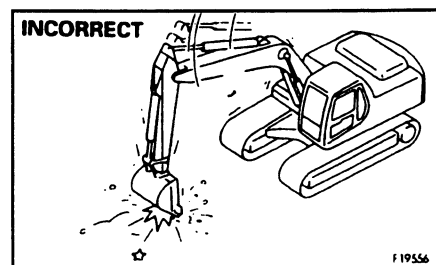

12. OPERATION

Prohibited operations using dropping force of machine.

Do not use the dropping force of the machine for digging.

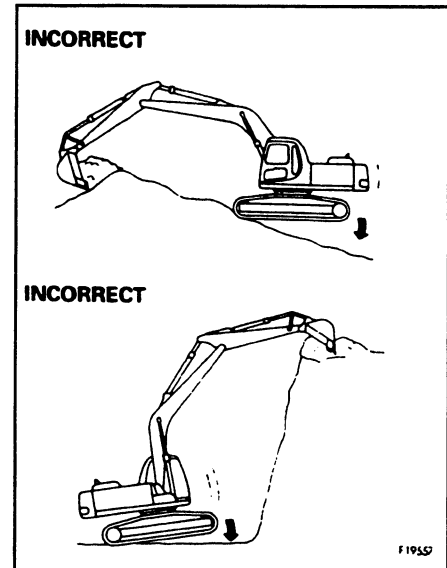

Digging rocky ground

It is better to excavate hard rocky ground after breaking it up by some other means. This will not only reduce damage to the machine but make for better economy.

Sudden lever shifting during HI-speed travel prohibited

- ① Never carry out sudden lever shifting as this may cause sudden starting.
- ② Avoid sudden lever shifting from forward to reverse (or vice versa)
- ③ Avoid sudden lever shifting change such as sudden stopping from near top speed (lever release operation).

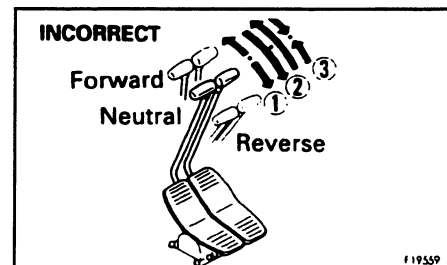

12.11 PRECAUTIONS FOR OPERATION

PRECAUTIONS WHEN TRAVELLING

When travelling over obstacles such as boulders or tree stumps, the machine (in particular, the undercarriage) is subjected to a large shock, so reduce the travel speed and travel over the obstacle at the center of the tracks. As far as possible, remove such obstacles or avoid travelling over them.

PRECAUTIONS AT HI-SPEED TRAVEL

On uneven roadbeds such as rock beds or uneven roads with large locks, travel at Mi or Lo speed. When Hi-speed travelling, set the idler in the forward direction.

PERMISSIBLE WATER DEPTH NOTICE

When driving the machine out of water, if the angle of the machine exceeds 15°, the rear of upper structure will go under water, and water will be thrown up by the radiator fan. This may cause the fan to break.

Be extremely careful when driving the machine out of water.

Do not immerse the machine in water by more than the permissible depth (under center of carrier roller ①).

In addition, for parts that have been immersed in water for a long time, pump in grease until the old grease comes out from the bearings. (Around the bucket pins)

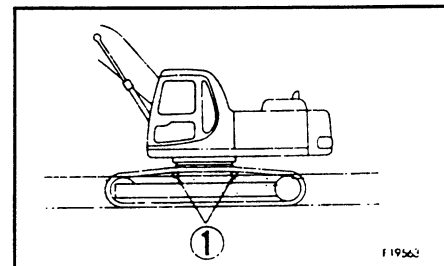
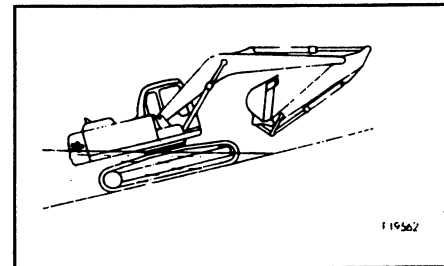
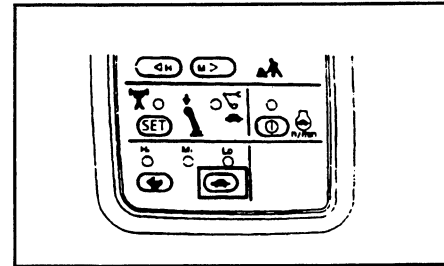
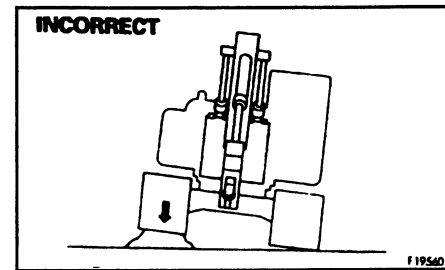

12.12 PRECAUTIONS WHEN TRAVELLING UP OR DOWN HILLS

⚠ WARNING

- When travelling, raise the bucket approx. 20 - 30 cm (8 - 12 in) from the ground. Do not travel downhill in reverse.
- When travelling over ridges or other obstacles, keep the work equipment close to the ground and travel slowly.
- It is dangerous to turn on slopes or to travel across slopes. Always go down to a flat place to perform these operations. It may be longer, but it will ensure safety.
- If the machine starts to slide or loses stability, lower the bucket immediately and brake the machine.
- Turning or operating the work equipment when working on slopes may cause the machine to lose its balance and turn over, so avoid such operations. It is particularly dangerous to swing downhill when the bucket is loaded. If such operations have to be carried out, pile soil to make platform on the slope so that the machine can be kept horizontal when operating.
- Do not travel on slopes of over 30° as there is danger that the machine may overturn.

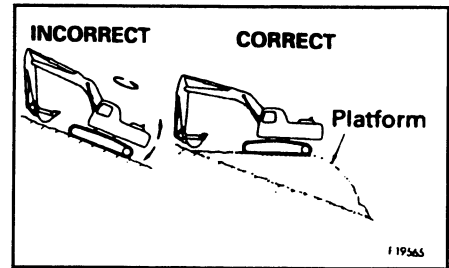
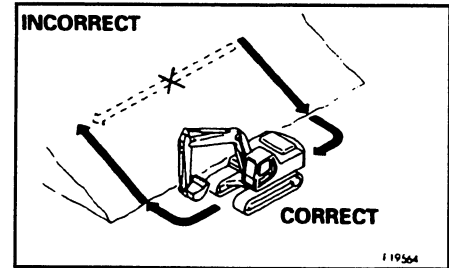

1) When travelling down steep hills, keep the travel speed low. When travelling down slopes of more than 15°, set the work equipment in the posture shown in the figure on the right, and lower the engine speed.

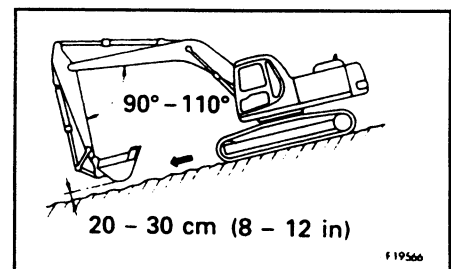

2) When travelling up a steep hill of more than 15°, set the work equipment in the posture shown in the diagram on the right.

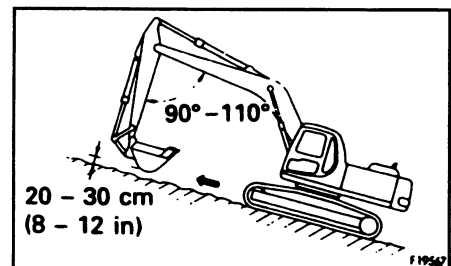

Braking when travelling downhill

To brake the machine during downhill runs, put the travelling and steering lever in the neutral position. This will cause the brake to be automatically applied.

If shoes slip

When travelling uphill, if the shoes slip or it is impossible to travel uphill using the force of the track only, it is possible to use pulling force of the arm to help the machine travel uphill.

If engine stops

If the engine stops when travelling uphill, lower the bucket to the ground, stop the machine, then start the engine again.

Precautions on slopes

- If the engine stops when the machine is on a slope, never use the left work equipment control lever to carry out swing operations. The upper structure will swing under its own weight.
- Do not open or close the door on the cab if the machine is on a slope. This may cause a sudden change in the operating force. Always keep the door locked.

12.13 HOW TO ESCAPE FROM MUD

Always operate carefully to avoid getting stuck in mud. If the machine does get stuck in mud, use the following procedures to get the machine out.

12.13.1 WHEN ONE SIDE IS STUCK

When only one side is stuck in mud, use the bucket to raise the track then lay boards or logs and drive the machine out. If necessary, put a board under the bucket also.

NOTICE

When using the boom or arm to raise the machine, always have the bottom of the bucket in contact with the ground. (Never push with the teeth). The angle between the boom and arm should be 90 to 110 . The same applies when using the inverting bucket.

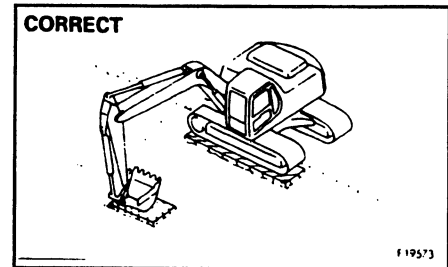

12.13.2 WHEN BOTH SIDES ARE STUCK

When both tracks are stuck in mud and the machine will not move, lay boards as explained above, and dig the bucket into the ground in front. Then pull in the arm as in normal digging operations and put the travel levers in the FORWARD position to pull the machine out.

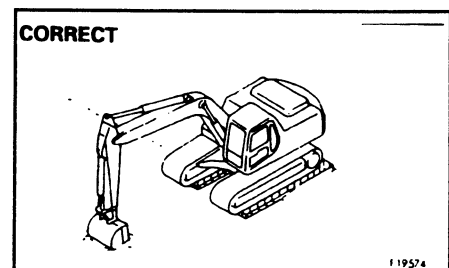

12.14 WORK POSSIBLE USING HYDRAULIC EXCAVATOR

In addition to the following, it is possible to further increase the range of applications by using various attachments.

12.14.1 BACKHOE WORK

When condition of the machine is as shown in the diagram at right, each cylinders maximum pushing excavation force is obtained when the bucket cylinder and link, arm cylinder and arm are at 90°.

When excavating, use this angle effectively to optimise your work efficiency.

The range for excavating with the arm is from a 45° angle away from the machine to a 30° toward the machine.

There may be some differences depending on the excavation depth, but try to use within the above range rather than going all the way to the extreme end of the cylinder stroke.

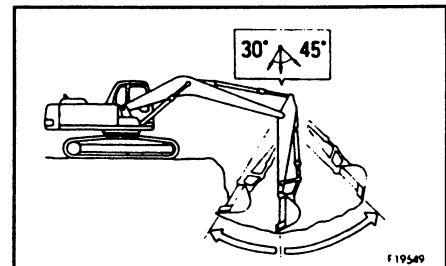
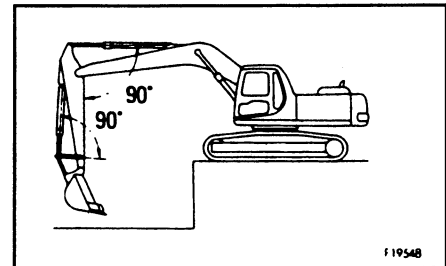

12.14.2 SHOVEL WORK

A shovel is suitable for excavating at a position higher than the machine. Shovel work is performed by attaching the bucket in the reverse direction.

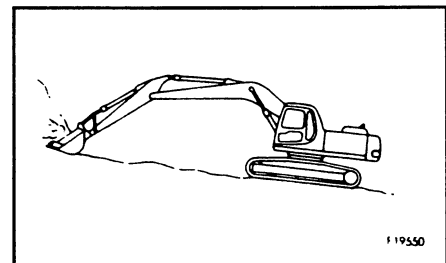

12.14.3 DITCHING WORK

Ditching work can be performed efficiently by attaching a bucket to match the width of the ditch and then setting the wheels parallel to the line of the ditch to be excavated.

To excavate a wide ditch, first dig out both sides and then finally remove the center portion.

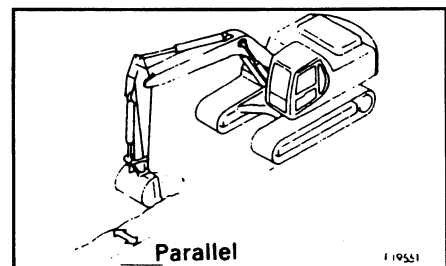

12.14.4 LOADING WORK

In places where the swing angle is small, work efficiency can be enhanced by locating the dump truck in a place easily visible to the operator.

Loading is easier and capacity greater if you begin from the front of the dump truck body than if loading is done from the side.

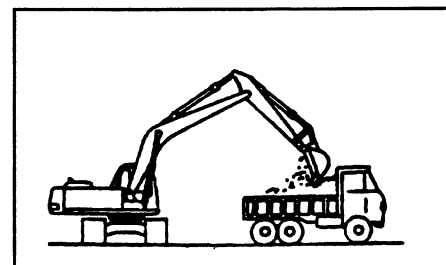

12.15 REPLACEMENT AND INVERSION OF BUCKET

⚠ WARNING

- When knocking the pin in with a hammer, metal particles may fly and cause serious injury, particularly if they get into your eyes. When carrying out this operation, always wear goggles, helmet, gloves, and other protective equipment.
- When the bucket is removed, place it in a stable condition.

Stop the machine on a firm, flat surface. When performing joint work, make clear signals to each other and work carefully for safety's sake.

12.15.1 REPLACEMENT

1. Place the bucket in contact with a flat surface.

REMARK

When removing the pins, place the bucket so that it is in light contact with the ground.

If the bucket is lowered strongly to the ground, the resistance will be increased and it will be difficult to remove the pins.

2. Remove the stopper bolts and nuts, then remove pins ① and ② and remove the bucket.

NOTICE

After removing the pins, make sure that they do not become contaminated with sand or mud and that the seals of bushing on both sides do not become damaged.

3. Align the arm with holes ① and the link with holes ②, then coat with grease and install pins ① and ②.

REMARK

When installing the bucket, the O-rings are easily damaged, so fit the O-rings on the boss of the arm end as shown in the diagram.

When knocking the pin, move the O-ring down to the regular groove.

4. Install the stopper bolts and nuts for each pin, then grease the pin.

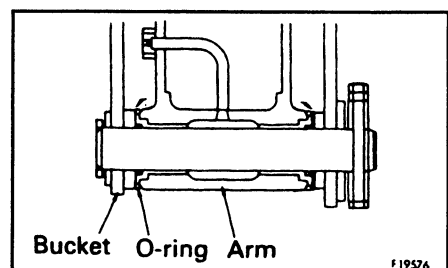
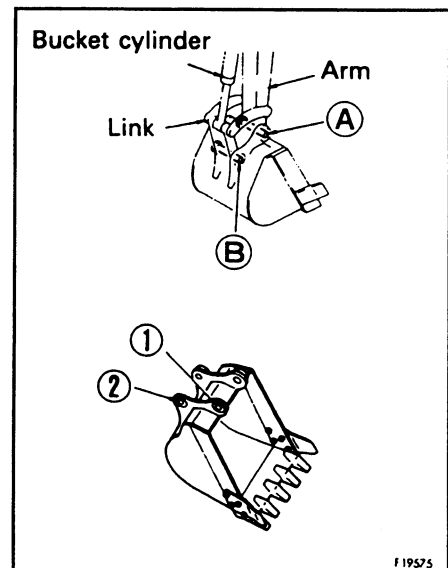

12.15.2 INVERSION

1. Place the bucket in contact with a flat surface.

REMARK

When removing the pins, place the bucket so that it is in light contact with the ground.

If the bucket is lowered strongly to the ground, the resistance will be increased and it will be difficult to remove the pins.

2. Remove the stopper bolts and nuts, then remove pins ① and ②, and remove the bucket.

NOTICE

After removing the pins, make sure that they do not become contaminated with sand or mud and that the seals of bushing on both sides do not become damaged.

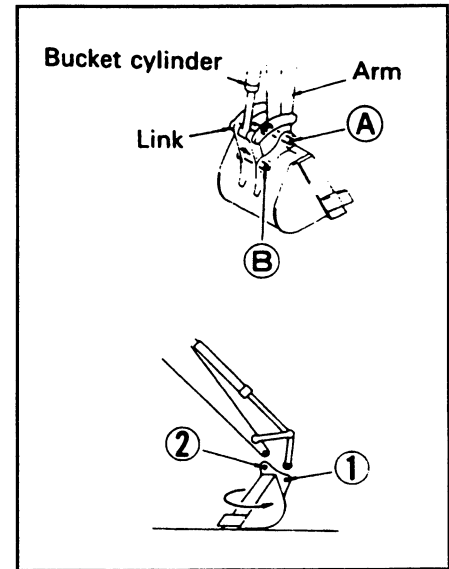

3. Install the bucket inversely.
After the bucket is inverted, correct the inclination and direction of the retaining pin holes ① and ② and stabilise the bucket securely.
4. Align the arm with holes ① and the link with holes ②, then coat with grease and install pins ① and ②.

REMARK

Install the O-rings into retaining hole ① of the arm and bucket.

When installing the bucket, the O-rings are easily damaged, so fit the O-rings on the boss of the arm end as shown in the diagram.

When knocking the pin, move the O-ring down to the regular groove.

5. Install the stopper bolts and nuts for each pin, then grease the pin.

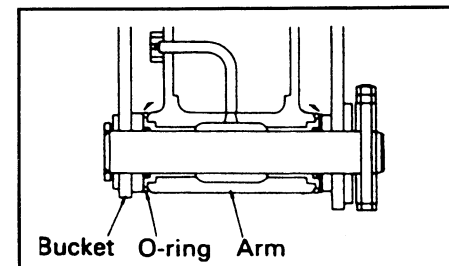
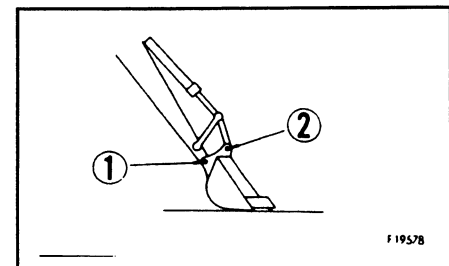

12.16 PARKING THE MACHINE

⚠ WARNING

- Avoid stopping suddenly. Give yourself ample room when stopping.
- When stopping the machine, select flat hard ground and avoid dangerous places. If it is unavoidably necessary to park the machine on a slope, insert chocks underneath the wheels. As an additional safety measure, thrust the bucket into the ground.
- If the control lever is touched by accident, the work equipment or the machine may move suddenly, and this may lead to a serious accident. Before leaving the operator's compartment, always set the safety lock lever securely to LOCK position.

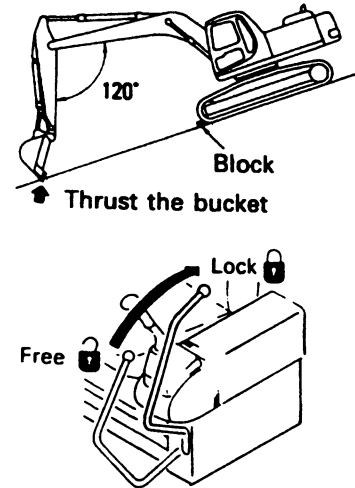

1. Put left and right levers ① in the neutral position. The machine stops.

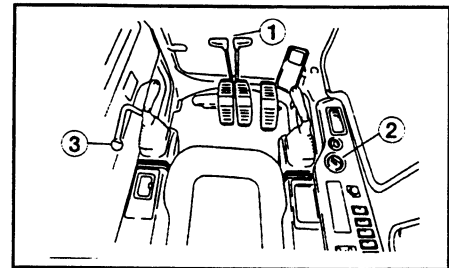

2. Turn fuel control dial ② to lower the engine speed to low idling.

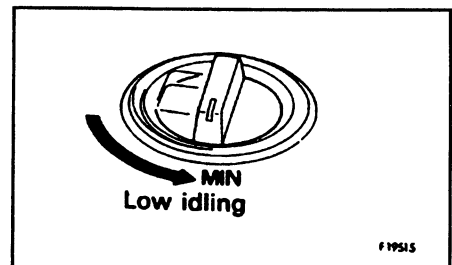
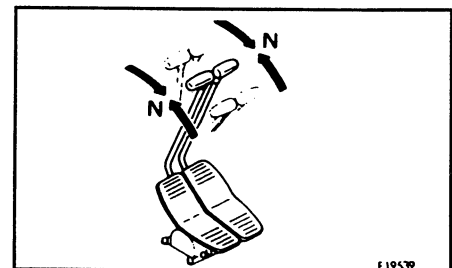

3. Lower the bucket horizontally until the bottom touches the ground.

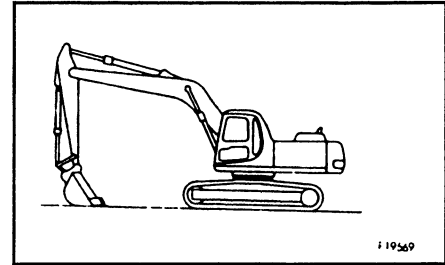

4. Set safety lock lever ③ in the LOCK position.

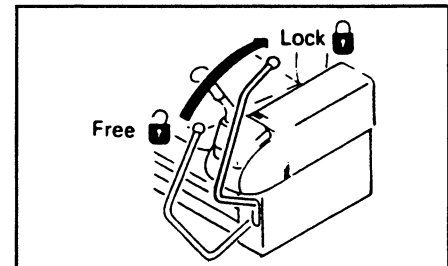

12.17 CHECK AFTER FINISHING WORK

Check the engine water temperature, engine oil pressure and fuel level on the monitor.

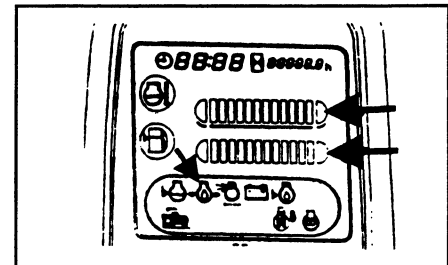

12.18 STOPPING ENGINE

NOTICE

If the engine is abruptly stopped before it has cooled down, engine life may be greatly shortened. Consequently, do not abruptly stop the engine apart from an emergency.

In particular, if the engine has overheated, do not abruptly stop it but run it at medium speed to allow it to cool gradually, then stop it.

1. Run the engine at low idling speed for about 5 minutes to allow it to gradually cool down.

2. Turn the key in starting switch ① to the OFF position and stop the engine.

3. Remove the key from starting switch ①.

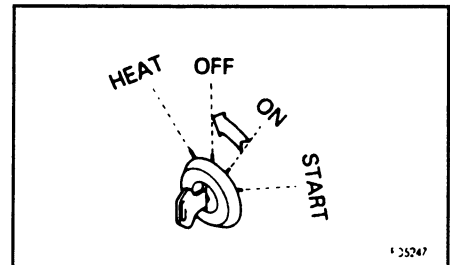
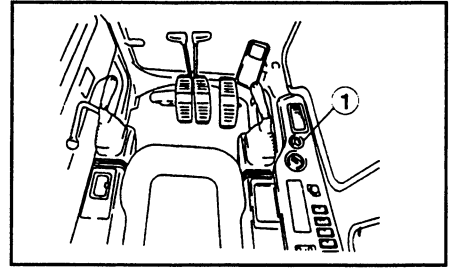

12.19 CHECK AFTER STOPPING ENGINE

1. Walk around the machine and check the work equipment, paintwork, and undercarriage, and check also for leakage of oil or water. If any abnormalities are found, repair them.
2. Fill the fuel tank.
3. Check the engine compartment for paper and debris. Clean out any paper and debris to avoid a fire hazard.
4. Remove any mud stuck to the undercarriage.

12.20 LOCKING

Always lock the following places.

- ① Door of operator's cab
Always remember to close the window.
- ② Fuel tank filler port
- ③ Engine hood
- ④ Battery box cover
- ⑤ Left side door of the machine
- ⑥ Right side door of the machine
- ⑦ Tool box
- ⑧ Hydraulic tank filler port

REMARK

Use the starting switch key to open and close all these places.

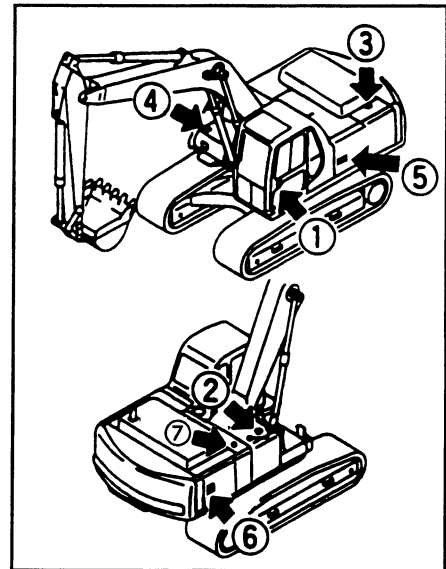

12.21 OVERLOAD WARNING DEVICE

This machine is fitted with this device to warn the operator when tipping over is a risk while lifting loads.

1. When lifting loads
 - 1) Remove bolt ① fastening the lever of the pressure switch and put roller ② of the lever against cam ③.
2. When not lifting loads
When the machine is performing any kind of operation other than lifting loads, fasten the pressure switch lever with the bolt away from the cam. This will prolong the life of the pressure switch and prevent unwanted sounding of warning buzzer.

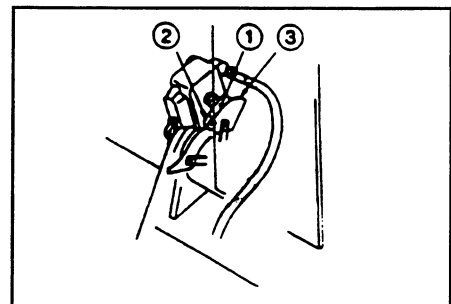

13. TRANSPORTATION

When transporting the machine, observe all related laws and regulations, and be careful to assure safety.

13.1 LOADING, UNLOADING WORK

WARNING

- Loading or unloading the machine can be a dangerous operation, so be particularly careful. When loading or unloading the machine, run the engine at low idling and travel at low speed.
- Make sure the ramp has sufficient width, length and thickness to enable the machine to be safely loaded and unloaded. If the ramp sags appreciably, reinforce it with blocks, etc.
- When loading and unloading the machine, park the trailer on a flat firm roadbed. Keep a fairly long distance between the road shoulder and the machine.
- Remove the mud from the undercarriage to prevent the machine from slipping to the side on slopes. Be sure the ramp surface is clean and free of grease, oil, ice and loose materials.
- Never change the direction of travel when on the ramps. If it is necessary to change direction, drive off the ramps and correct the direction, then drive on to the ramps again.
- When turning the machine on the trailer, the machine's footing is unstable, so carry out the operation slowly.
- Always check that the door on the cab is locked, regardless of whether it is open or closed. Do not open or close the door on ramps or on a platform. This may cause a sudden change in the operating force.
- When loading or unloading the machine with the automatic warming-up operation mode, if the automatic mode is released, the speed may change suddenly. Avoid loading or unloading during automatic warming-up operation.

When loading or unloading, always use ramps or a platform and carry out the operations as follows.

1. Properly apply the brakes on the trailer and insert blocks beneath the tyres to ensure that it does not move. Then fix the ramps in line with the centers of the trailer and the machine. Be sure that the two sides are at the same level as one another.

Make the angle of the ramps a maximum of 15°. Set the distance between the ramps to match the center of the tracks.

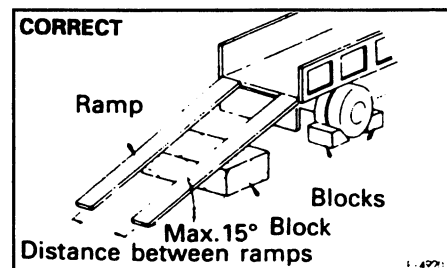

2. Set the travel speed switch to the Lo position.

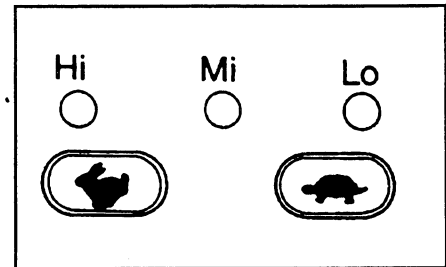

3. Turn the auto-deceleration switch OFF, and return the fuel control dial to reduce the engine speed.

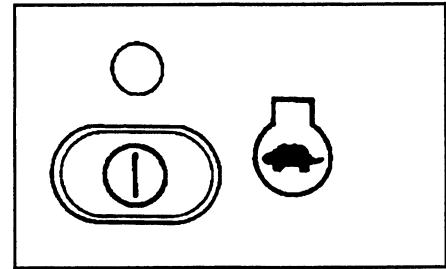

4. Turn the swing lock switch ON to apply the swing lock.
5. Set in the direction of the ramps, lower the work equipment as far as possible without letting it hit the trailer, then travel slowly to load or unload the machine.

When on the ramps, do not operate any lever other than the travel lever.

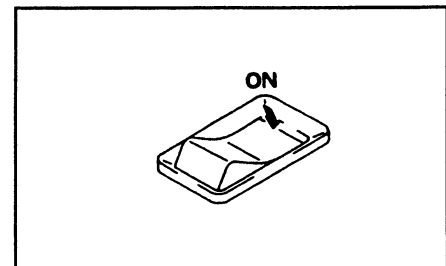

6. Load the machine correctly in the specified position on the trailer.

REMARK

When the work equipment is installed, load the machine from the front; when the work equipment is not installed, load the machine from the rear.

13.2 PRECAUTIONS FOR LOADING

⚠ WARNING

When loading the machine, park the trailer on a flat firm road-bed. Keep a fairly long distance between the road shoulder and the machine.

After loading to the specified position, secure the machine as follows.

1. Fully extend the bucket and arm cylinders, then slowly lower the boom.
2. Stop the engine and remove the key from the starting switch.
3. Lock all the control levers securely with the safety lock lever.
4. When transporting the machine, place rectangular timber underneath the front and rear track shoes to prevent the machine from moving about. Also, hold it down with chains or rope. Be particularly careful to ensure that the machine does not slip sideways.

NOTICE

When transporting the machine, place rectangular timber under one end of the bucket cylinder to prevent it touching the ground, thereby saving it from possible damage.

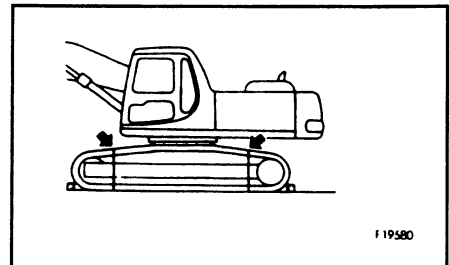
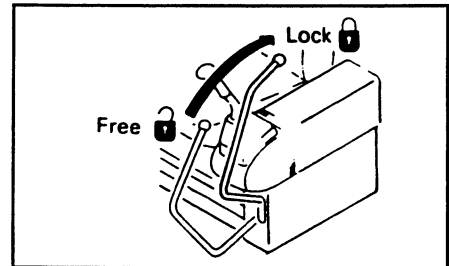
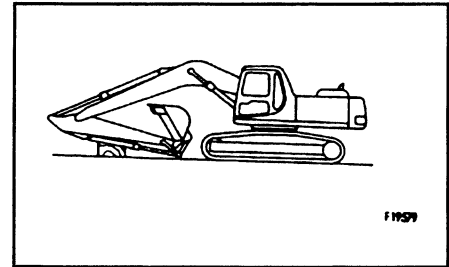

13.3 PRECAUTIONS FOR TRANSPORTATION

⚠ WARNING

- Determine the route for transporting the machine by taking into account the width, height and weight of the machine.
- Always check that the door on the cab is closed and locked before transporting the machine.

Obey all state and local laws governing the weight, width and length of a load. Observe all regulations governing wide loads.

13.4 LIFTING THE MACHINE

How to lift a machine

Personnel who perform lifting using a crane must be qualified.

⚠ PRECAUTION

Contact your distributor to get an instruction of lifting a machine. Some parts are required and available as optional parts.

⚠ WARNING

- Do not lift a machine with personnel in it.
- The rope used for lifting must have sufficient strength to withstand the weight of this machine.
- The machine must not be in a position other than that shown in the following procedure when lifting a vehicle. Otherwise, the machine may be unbalanced.

Before lifting the machine, place the machine on a flat horizontal surface and follow the procedure shown below.

- 1) Set the machine to the position shown in the figure on the right by fully extending all cylinders. (Boom at its highest point, arm and bucket fully retracted).
- 2) Set the safety lock lever in the lock position.
- 3) Switch the engine off and confirm any loose objects are placed in the storage compartment behind the operators seat.
- 4) Make sure the front windshield is closed and securely locked.
- 5) Get out of the machine, close the cab door and lock it.
- 6) Close and lock, left and right hand machine cab doors, battery compartment and engine hood.
- 7) Attach the correct strength lifting shackles to the lifting hooks on the Boom and Counterweight.
- 8) Hang the wire rope.
NOTE: The wire rope length(s) and angles must be as shown in the figure on the right.

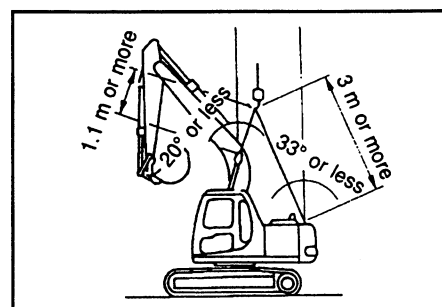
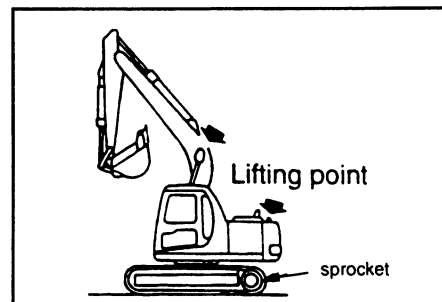

13. TRANSPORTATION

- 9) On commencement of lifting.
Take up slack in the rope and check for work equipment movement, (due to possible hydraulic drift) adjust lifting hook position, if required, to maintain rope length(s) and angles as shown in the figure on the right.
- 10) Lift until the machine leaves the ground. At this point stop lifting and check the balance of the machine.
- 11) If the machine is unstable lower and adjust rope and lifting hook position.
- 12) Repeat steps 10) and 11) until machine stability is achieved then slowly commence lifting operation.

14. COLD WEATHER OPERATION

14.1 PRECAUTIONS FOR LOW TEMPERATURE

If the temperature becomes low, it becomes difficult to start the engine, and the coolant may freeze, so do as follows.

14.1.1 FUEL AND LUBRICANTS

Change to fuel and oil with low viscosity for all components. For details of the specified viscosity, see 20. "USE OF FUEL, COOLANT AND LUBRICANTS ACCORDING TO AMBIENT TEMPERATURE".

14.1.2 COOLANT



WARNING

Keep antifreeze fluid away from an open flame. Never smoke when using antifreeze.

NOTICE

- Never use methanol, ethanol or propanol based antifreeze.
- Absolutely avoid using any water leak preventing agent irrespective of whether it is used independently or mixed with an antifreeze.
- Do not mix one antifreeze with a different brand.

For details of the antifreeze mixture when changing the coolant, see "24.2 WHEN REQUIRED".

Use a Permanent Antifreeze (ethylene glycol mixed with corrosion inhibitor, antifoam agent, etc.) meeting the standard requirements as shown below. With permanent antifreeze, no change of coolant is required for a year. If it is doubtful that an available antifreeze meets the standard requirements, ask the supplier of that antifreeze for information.

Standard requirements for permanent antifreeze

- SAE J1034
- FEDERAL STANDARD O-A-548D

REMARK

Where no permanent antifreeze is available, an ethylene glycol antifreeze without corrosion inhibitor may be used only for the cold season. In this case, clean the cooling system twice a year (in spring and autumn). When refilling the cooling system, add antifreeze in autumn, but do not add any in spring.

14.1.3 BATTERY



WARNING

- To avoid gas explosions, do not bring fire or sparks near the battery.
- Battery electrolyte is dangerous. If it gets in your eyes or on your skin, wash it off with large amounts of water, and consult a doctor.

When the ambient temperature drops, the capacity of the battery will also drop. If the battery charge ratio is low, the battery electrolyte may freeze. Maintain the battery charge as close as possible to 100%, and insulate it against cold temperature so that the machine can be started easily the next morning.

REMARK

Measure the specific gravity and calculate the rate of charge from the following conversion table.

Temp. of fluid Rate of charge	20°C (68°F)	0°C (32°F)	-10° (14°F)	-20° (-4°F)
	100%	1,28	1,29	1,30
90%	1,26	1,27	1,28	1,29
80%	1,24	1,25	1,26	1,27
75%	1,23	1,24	1,25	1,26

14.2 PRECAUTIONS AFTER COMPLETION OF WORK

To prevent mud, water, or the undercarriage from freezing and making it impossible for the machine to move the following morning, always observe the following precautions.

- Mud and water on the machine body should be completely removed. This is to prevent damage to the seal caused by mud or dirt getting inside the seal with frozen drops of water.
- Park the machine on hard, dry ground. If this is impossible, park the machine on wooden boards. The boards help protect the tracks from being frozen in soil and the machine can start next morning.
- Open the drain valve and drain any water collected in the fuel system to prevent it from freezing.
- After operation in water or mud, remove water from undercarriage as described below, to extend undercarriage service life.

WARNING

Performing idle-running of tracks is potentially dangerous so stay well away from tracks at this time.

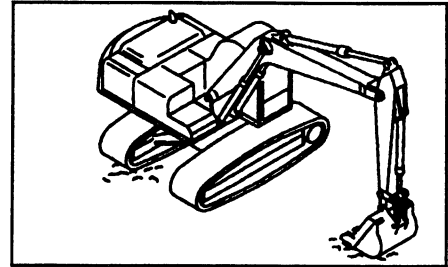

1. Swing by 90° with engine at low idle and bring work equipment beside track.
 2. Slightly float track by slowly pushing the ground and cause track to idle-run. Perform this for the opposite track, too.
- As the battery capacity drops markedly in low temperatures, cover the battery or remove it from the machine, keep it in a warm place, and install it again the next morning.
 - If electrolyte level is found low, add distilled water in the morning before beginning work. Do not add the water after the day's work so as to prevent fluid in the battery from freezing in the night.

14.3 AFTER COLD WEATHER

When season changes and the weather becomes warmer, do as follows.

- Replace the fuel and oil for all parts with oil of the viscosity specified. For details, see 20. "USE OF FUEL, COOLANT AND LUBRICANTS ACCORDING TO AMBIENT TEMPERATURE".
- If for any reason permanent antifreeze cannot be used, and an ethyl glycol base antifreeze (winter, one season type) is used instead, or if no antifreeze is used, drain the cooling system completely, then clean out the inside of the cooling system thoroughly, and fill with fresh water.

15. LONG-TERM STORAGE

15.1 BEFORE STORAGE

NOTICE

To protect the cylinder rod when the machine is not being used, set the work equipment in the posture shown in the diagram. (This prevents rusting of the cylinder rod)

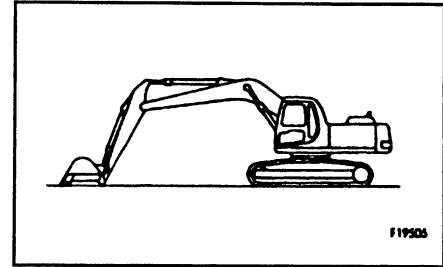

When putting the machine in storage for a long time, do as follows.

- After every part is washed and dried, the machine shall be housed in a dry building. Never leave it outdoors. In case it is unavoidable to leave it outdoors, park the machine on the well-drained concrete and cover it with canvas etc.
- Completely fill the fuel tank, lubricate and change the oil before storage.
- Apply a thin coat of grease to metal surface of the hydraulic piston rods.
- Disconnect the negative terminals of the battery and cover it, or remove it from the machine and store it separately.
- If the ambient temperature is expected to drop below 0°C, always add antifreeze to the cooling water.
- Lock each control lever and pedal with the lock lever and pedal lock.
- Set the stop valve to the “lock” position on machines ready for attachments. Install the blind plugs to the elbows.
- Set the selector valve to the “When not use” position on machines ready for attachments.

15.2 DURING STORAGE

 **WARNING**

If it is unavoidably necessary to carry out the rustpreventive operation while the machine is indoors, open the doors and windows to improve ventilation and prevent gas poisoning.

Operate the engine and move the machine for a short distance once a month so that a new film of oil will be coated over movable parts and component surfaces. At the same time, also charge the battery.

Also carry out cooler operation in the case of machines equipped with an air conditioner.

15.3 AFTER STORAGE

NOTICE

If the machine is stored without carrying out the monthly rust prevention operation, request your Komatsu distributor for service.

Carry out the following procedure when taking the machine out of long-term storage.

- Wipe off the grease from the hydraulic cylinder rods.
- Add oil and grease to all places.

15.4 STARTING MACHINE AFTER LONG-TERM STORAGE

When starting the machine after a long-term storage, first cancel the automatic warming-up function as follows.

- 1 Turn the starting switch key to the ON position.
2. Turn the fuel control dial from the low idling (MIN) position to the full (MAX) position, hold it there for 3 seconds, then return it to the low idling (MIN) position and start the engine.

16. TROUBLESHOOTING

16.1 PHENOMENA THAT ARE NOT FAILURES

Note that the following phenomena are not failures:

1. When the arm is pulled in, the speed of movement will drop momentarily when the arm is more or less vertical.
2. The arm speed will drop momentarily when the bucket teeth are more or less horizontal.
3. When starting or stopping the swing, noise will be emitted from the brake valve.
4. When going down a steep slope at low speed, a noise will be emitted from the travel motor.

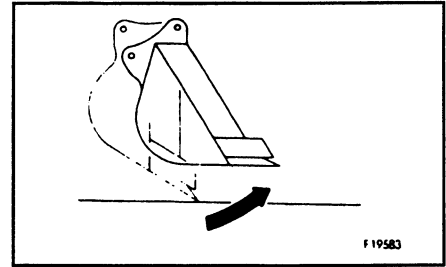
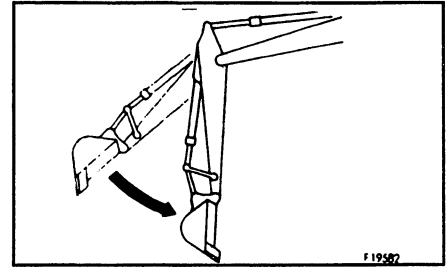

16.2 METHOD OF TOWING MACHINE

WARNING

When towing the machine, use a wire rope that has ample strength for the weight of the machine that is being towed.

If the machine sinks in mud and cannot get out under its own power, or if the drawbar pull of the excavator is being used to tow a heavy object, use a wire rope as shown in the diagram on the right. Place pieces of wood between wire ropes and body to prevent damage to ropes and body. At this time, never use the towing hole which is intended only for light-weight towing.

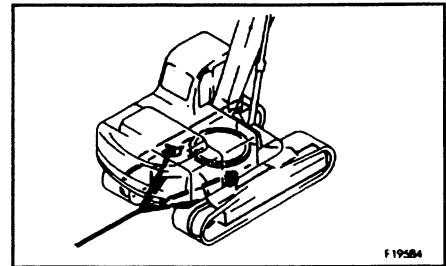

16.3 USING METHOD FOR LIGHT-WEIGHT TOWING HOLE

WARNING

- The shackle must always be used.
- Hold the rope level and direct it straight to the track frame.
- Move the machine slowly in the Lo mode.

The track frame has been equipped with a towing hole to pass the shackle through for towing light objects.

In this case, the traction load must be 130 KN or less.

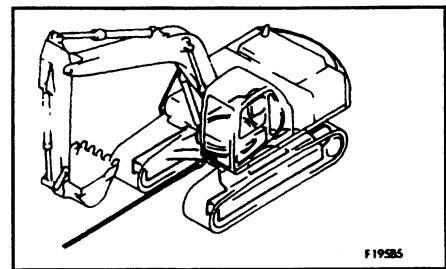

16.4 PRECAUTIONS ON PARTICULAR JOBSITES

1. When carrying out digging operations in water, if the work equipment mounting pin goes into the water, carry out greasing every time the operation is carried out.
2. For heavy-duty operations and deep digging, carry out greasing of the work equipment mounting pins every time before operation.

After greasing, operate the boom, arm and bucket several times, then grease again.

16.5 IF BATTERY IS DISCHARGED

⚠ WARNING

- When checking or handling the battery, stop the engine and turn the starting switch key to the OFF position before starting.
- The battery generates hydrogen gas, so there is danger of explosion. Do not bring lighted cigarettes near the battery, or do anything that will cause sparks.
- Battery electrolyte is dilute sulphuric acid, and it will attack your clothes and skin. If it gets on your clothes or on your skin, wash it immediately with large amounts of water. If it gets in your eyes, wash it out with fresh water, and consult a doctor.
- When handling battery, always wear protective goggles.
- When removing the battery, first disconnect the cable from the ground (normally, from the negative - terminal). When installing, install the positive + terminal first. If a tool touches the cable connecting the positive terminal and the chassis, there is danger that it will cause sparks.
- If the terminals are loose, there is danger that the defective contact may generate sparks that will cause an explosion. When installing the terminals, install them tightly.
- When removing or installing, check which is the positive + terminal and negative - terminal.

When removing, disconnect the cable from the ground terminal first.

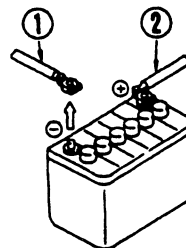

When installing, connect the cable to the positive (+) terminal first.

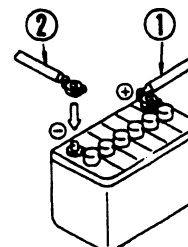

16.5.1 STARTING ENGINE WITH BOOSTER CABLE

When starting the engine with a booster cable, do as follows:

Precautions when connecting and disconnecting booster cable

WARNING

- When connecting the cables, never contact the positive + and negative - terminals.
- When starting the engine with a booster cable, always wear safety glasses.
- Be careful not to let the normal machine and problem machine contact each other. This prevents sparks from generating near the battery which could ignite the hydrogen gas given off by the battery. If hydrogen gas explodes, it could cause serious injury.
- Make sure that there is no mistake in the booster cable connections. The final connection is to the revolving frame, but sparks will be generated when this is done, so connect to a place as far as possible from the battery. (However, avoid connecting the cable to the work equipment, as conduction is poor.)
- Use care when removing the cables from the machine that has been started. Do not allow the cable ends to contact each other or the machine, to avoid hydrogen explosion.

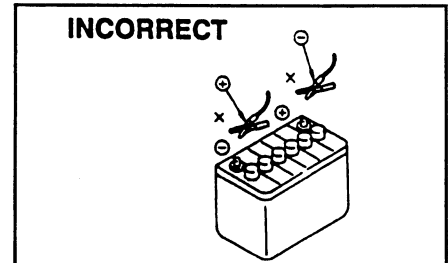

NOTICE

- The size of the booster cable and clip should be suitable for the battery size.
- The battery of the normal machine must be the same capacity as that of the engine to be started.
- Check the cables and clips for damage or corrosion.
- Make sure that the cables and clips are firmly connected.

Connecting the booster cables

Keep the starting switch at the OFF position.

Connect the booster cable as follows, in the order of the numbers marked in the diagram.

1. Make sure that the starting switches of the normal machine and problem machine are both at the OFF position.
2. Connect one clip of booster cable **A** to the positive (+) terminal of the problem machine.
3. Connect the other clip of booster cable **A** to the positive (+) terminal of the normal machine.
4. Connect one clip of booster cable **B** to the negative (-) terminal of the normal machine.
5. Connect the other clip of booster cable **B** to the engine block of the problem machine.

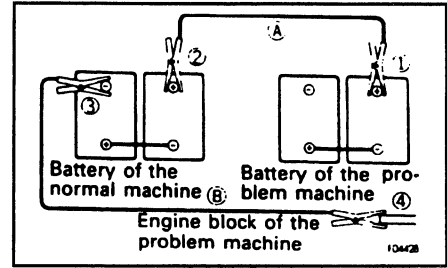

Starting the engine

1. Make sure the clips are firmly connected to the battery terminals.
2. Start the engine of the normal machine and keep it to run at high idling speed.
3. Turn the starting switch of the problem machine to the START position and start the engine. If the engine doesn't start at first, try again after 2 minutes or so.

Disconnecting the booster cables

After the engine has started, disconnect the booster cables in the reverse of the order in which they were connected.

1. Remove one clip of booster cable ② from the engine block of the problem machine.
2. Remove the other clip of booster cable ② from the negative (-) terminal of the normal machine.
3. Remove one clip of booster cable ① from the positive (+) terminal of the normal machine.
4. Remove the other clip of booster cable ① from the positive (+) terminal of the problem machine.

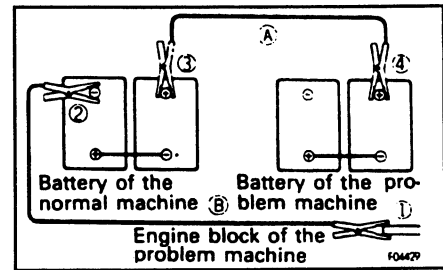

16.6 OTHER TROUBLE

16.6.1 ELECTRICAL SYSTEM

- (): Always contact your Komatsu distributor when dealing with these items.
- In cases of abnormalities or causes which are not listed below, please contact your Komatsu distributor for repairs.

Problem	Main causes	Remedy
Lamp does not glow brightly even when the engine runs at height speed	<ul style="list-style-type: none"> • Defective wiring • Defective adjustment of fan belt tension 	<ul style="list-style-type: none"> • (Check, repair loose terminals, disconnections) • Adjust fan belt tension For details, see "EVERY 250 HOURS SERVICE"
Lamp flickers while engine is running		
Charge level monitor does not go out even when engine is running	<ul style="list-style-type: none"> • Defective alternator • Defective wiring 	<ul style="list-style-type: none"> (• Replace) (• Check, repair)
Abnormal noise is generated from alternator	<ul style="list-style-type: none"> • Defective alternator 	<ul style="list-style-type: none"> (• Replace)
Starting motor does not turn when starting switch is turned to ON.	<ul style="list-style-type: none"> • Defective wiring • Insufficient battery charge 	<ul style="list-style-type: none"> (• Check, repair) • Charge
Pinion of starting motor keeps going in and out	<ul style="list-style-type: none"> • Insufficient battery charge 	<ul style="list-style-type: none"> • Charge
Starting motor turns engine sluggishly	<ul style="list-style-type: none"> • Insufficient battery charge • Defective starting motor 	<ul style="list-style-type: none"> • Charge (• Replace)
Starting motor disengages before engine starts	<ul style="list-style-type: none"> • Defective wiring • Insufficient battery charge 	<ul style="list-style-type: none"> (• Check, repair) • Charge
Pre-heating monitor does not light	<ul style="list-style-type: none"> • Defective wiring • Defective heater relay • Defective monitor 	<ul style="list-style-type: none"> (• Check, repair) (• Replace) (• Replace)
Oil pressure monitor does not light up when engine is stopped (starting switch at ON position)	<ul style="list-style-type: none"> • Defective monitor • Defective caution lamp switch 	<ul style="list-style-type: none"> (•Replace) (•Replace)
Outside of electrical heater is not warm when touched by hand	<ul style="list-style-type: none"> • Defective wiring • Disconnection in electric heater • Defective operation of heater switch 	<ul style="list-style-type: none"> (• Check, repair) (• Replace) (• Replace)

16.6.2 CHASSIS

- (): Always contact your Komatsu distributor when dealing with these items.
- In cases of abnormalities or causes which are not listed below, please contact your Komatsu distributor for repairs.

Problem	Main causes	Remedy
Speed of travel, swing, boom, arm, bucket is slow	<ul style="list-style-type: none"> • Lack of hydraulic oil 	<ul style="list-style-type: none"> • Add oil to specified level, see "CHECK BEFORE STARTING"
Pump generates abnormal noise	<ul style="list-style-type: none"> • Clogged element in hydraulic tank strainer 	<ul style="list-style-type: none"> • Clean, see "EVERY 2000 HOURS SERVICE"
Excessive rise in hydraulic oil temperature	<ul style="list-style-type: none"> • Loose fan belt • Dirty oil cooler • Lack of hydraulic oil 	<ul style="list-style-type: none"> • Adjust fan belt tension, see "EVERY 250 HOURS SERVICE" • Clean, see "EVERY 500 HOURS SERVICE" • Add oil to specified level, see "CHECK BEFORE STARTING"
Track comes off	<ul style="list-style-type: none"> • Track too loose 	<ul style="list-style-type: none"> • Adjust track tension, see "WHEN REQUIRED"
Abnormal wear of sprocket		
Bucket rises slowly, does not rise	<ul style="list-style-type: none"> • Lack of hydraulic oil 	<ul style="list-style-type: none"> • Add oil to specified level, see "CHECK BEFORE STARTING"

16. TROUBLESHOOTING

16.6.3 ENGINE

- (): Always contact your Komatsu distributor when dealing with these items.
- In cases of abnormalities or causes which are not listed below, please contact your Komatsu distributor for repairs.

Problem	Main causes	Remedy
Engine oil pressure monitor lights up	<ul style="list-style-type: none"> • Engine oil pan oil level is low (sucking in air) • Clogged oil filter cartridge • Defective tightening of oil pipe joint, oil leakage from damaged part • Defective engine oil pressure sensor 	<ul style="list-style-type: none"> • Add oil to specified level, see "CHECK BEFORE STARTING" • Replace cartridge, see "EVERY 500 HOURS SERVICE" (* Check, repair) (* Replace sensor)
Steam is emitted from top part of radiator (pressure valve)	<ul style="list-style-type: none"> • Cooling water level low, water leakage • Loosen fan belt • Dirt or scale accumulated in cooling system 	<ul style="list-style-type: none"> • Add cooling water, repair, see "CHECK BEFORE STARTING" • Adjust fan belt tension, see "EVERY 1000 HOURS SERVICE" • Change cooling water, clean inside of cooling system, see "WHEN REQUIRED"
Radiator water level monitor lights up	<ul style="list-style-type: none"> • Clogged radiator fin or damaged fin • Defective thermostat • Loose radiator filler cap (high altitude operation) • Defective water level sensor 	<ul style="list-style-type: none"> • Clean or repair, see "EVERY 500 HOURS SERVICE" (* Replace thermostat) • Tighten cap or replace packing (* Replace sensor)
Engine does not start when starting motor is turned	<ul style="list-style-type: none"> • Lack of fuel • Air in fuel system • Defective fuel injection pump or nozzle • Starting motor cranks engine sluggishly • Preheating monitor does not light up • Defective compression • Defective valve clearance • Contaminated fuel • Lift pump not working • Fuel filter clogged • Fuel lines blocked 	<ul style="list-style-type: none"> • Add fuel, see CHECK "BEFORE STARTING" • Repair place where air is sucked in, see "EVERY 500 HOURS SERVICE" (* Replace pump or nozzle) <div style="border: 1px solid black; width: 20px; height: 20px; display: inline-block; vertical-align: middle;"></div> See ELECTRICAL SYSTEM (* Adjust valve clearance) • Drain & clean fuel system • Check/replace pump • Change filters • Check/blow out lines

ENGINE (cont'd) (16.6.3)

Problem	Main causes	Remedy
Exhaust gas is white or blue	<ul style="list-style-type: none"> • Too much oil in oil pan • Improper fuel 	<ul style="list-style-type: none"> • Add oil to specified level see "CHECK BEFORE STARTING" • Change to specified fuel
Exhaust gas occasionally turns black	<ul style="list-style-type: none"> • Clogged air cleaner element • Defective nozzle • Defective compression • Defective turbocharger 	<ul style="list-style-type: none"> • Clean or replace, see "WHEN REQUIRED" (• Replace nozzle) (• See defective compression above) (• Clean or replace turbocharger)
Combustion noise occasionally makes breathing sound	<ul style="list-style-type: none"> • Defective nozzle 	<ul style="list-style-type: none"> (• Replace nozzle)
Abnormal noise generated (combustion or mechanical)	<ul style="list-style-type: none"> • Low grade fuel being used • Overheating • Damage inside muffler • Excessive valve clearance 	<ul style="list-style-type: none"> • Change to specified fuel • Refer to "Radiator water level monitor lights up" as above (• Replace muffler) (• Adjust valve clearance)

16.6.4 ELECTRONIC CONTROL SYSTEM

If an error code appears on the machine monitor display (normally displays TIME), follow the countermeasure table as shown below in the self-diagnosis.

Machine monitor trouble display

Monitor display	Error Mode	Countermeasure
EO2	TVC valve system error	If the pump override switch is set to the ON position, operation can be carried out. However, immediately have the TVC valve system inspected by your Komatsu distributor. (*)
EO3	Swing brake system error	Set the swing override switch to the ON position to release the brake. If applying the swing brake, manually operate the swing brake using the swing lock switch. In this case, immediately have the swing brake system inspected by your Komatsu distributor. (*)
EO5	Governor system error	Governor will not execute the control function. Manually operate the governor-lever. To fix the the governor lever at the full stroke position, use the retaining bolt holes on bracket. In this case, immediately have the governor system inspected by your Komatsu distributor.
CALL	Error indicating that operation cannot be continued	Place the machine in a safe posture, then have it inspected immediately by your Komatsu distributor.
In the case where the monitor will not display error codes and work equipment operation and swing operation cannot be carried out.		Carry out inspection immediately

(*) For detail of operating the pump override switch and the swing override switch, refer to 11.3 "SWITCHES"

MAINTENANCE

 **WARNING**

Before carrying out maintenance, always attach the warning tag to the control lever in the operator's cab .

17. GUIDES TO MAINTENANCE

Do not carry out any inspection and maintenance operation that is not given in this manual. Perform maintenance work on hard, flat ground.

Check service meter:

Check the service meter reading every day to see if the time has come for any necessary maintenance to be carried out.

Komatsu genuine replacement parts:

Use Komatsu genuine parts specified in the Parts Book as replacement parts.

Komatsu genuine oils:

Use Komatsu genuine oils and grease. Choose oils and grease with proper viscosity's specified for ambient temperature.

Always use clean washer fluid:

Use automobile window washer fluid and be careful not to let any dirt get into it.

Always use clean oil and grease:

Use clean oil and grease. Also, keep containers of the oil and grease clean. Keep foreign materials away from oil and grease.

Keeping the machine clean:

Always keep the machine clean. This makes it easier to find parts causing problems. Keep in particular grease fittings, breathers and oil level gauges clean and avoid foreign matters from getting in them.

Be careful of hot water and oil:

Draining hot oils and coolants and removing their filters immediately after the engine stops is hazardous. Allow the engine to cool.

If the oil has to be drained when it is cold, warm up the oil to a suitable temperature (approx. 20 - 40°C) before draining it.

Checking foreign materials in drained oil and on filter:

After oil is changed or filters are replaced, check the oil and filters for metallic particles and foreign materials. If large quantities of metallic particles or foreign materials are found, consult your Komatsu distributor.

Fuel strainer:

If your machine is equipped with a fuel strainer, do not remove it while fuelling.

Oil change:

Check or change oils in the places where dust is scarce to keep foreign materials away from oils.

Warning tag:

Attach the warning tag to the starting switch or other appropriate control lever to avoid someone who is not aware of the circumstances from starting the engine.

Obey precautions:

During the operation, always obey the precautions on the safety label attached to the machine.

Welding instructions:

- Turn off the engine starting switch.
- Do not apply more than 200 V continuously.
- Connect grounding the cable within 1 m from the area to be welded.
- Avoid seals or bearings from being between the area to be welded and the position of grounding point
- Do not use the area around the work equipment pins or the hydraulic cylinders as the grounding point.

Fire prevention

Use non-flammable cleaner or light oil for cleaning parts. Keep flame or cigarette light away from light oil.

Clamp faces:

When O-rings or gaskets are removed, clean the clamp faces and replace the O-rings and gaskets with new ones. Be sure to fit O-rings and gaskets when assembling.

Objects in your pockets:

Keep your pockets free of loose objects which can fall out and drop into the machinery; especially when you work on the machinery while bending over it.

Checking undercarriage:

When working in rocky areas, check for damage to the undercarriage and for looseness, flaws, wear and damage in bolts and nuts. Loosen the track tension a little when working in such areas.

Precautions when washing machine:

- Never spray steam or water directly on the connectors and mechatronics parts.
- Do not allow water to get on the monitors and controllers inside the operator's cab.
- Never spray steam or water directly at the radiator or oil cooler portions.

Pre-and post-work checks:

Before starting work in mud, rain, snow or at seashore, check plugs and valves for tightness. Wash the machine immediately after the work to protect components from rusting. Lubricate components more frequently than usual. Be sure to lubricate work equipment pins daily if they are submerged in water.

When working at dusty worksites, do as follows:

- Inspect the air cleaner clogging monitor to see whether the air cleaner is blocked up. Clean the air cleaner at shorter intervals than specified.
- Clean the radiator core frequently to avoid clogging.
- Clean and replace the fuel filter frequently.
- Clean electrical components, especially the starting motor and alternator, to avoid accumulation of dust.

Avoid mixing oils:

Never mix oils of different brands. If you have only oil which is a different brand from the one that is used in the machine, do not add it but replace all the oil.

18. OUTLINES OF SERVICE

- Use Komatsu genuine parts for replacement.
- When changing or adding oil, do not use a different type of oil.
- Unless otherwise specified, the oil and coolant used at the time of shipment from the factory are as shown in the table below.

Item	Kind of fluid
Engine oil pan	SAE 15W-40 API classification CE or CF-4
Swing machinery case Final drive case Damper case	SAE 30 API classification CD
Hydraulic tank	SAE 10W API classification CD
Fuel tank	ASTM D975 No.2 (However, ASTM D975 No.1 is used for the winter season (October to March))
Radiator	Komatsu Super Coolant (AF-ACL) 50% added to water

18.1 OUTLINE OF OIL, FUEL, COOLANT

18.1.1 OIL

- Oil is used in the engine and work equipment under extremely severe conditions (high temperature, high pressure), and it deteriorates with use.
Always use oil that matches the grade and temperature for use given in the Operation and Maintenance Manual. Even if the oil is not dirty, always replace the oil after the specified interval.
- Oil corresponds to blood in the human body, so always be careful when handling it to prevent any impurities (water, metal particles, dirt, etc.) from getting in.
The majority of problems with machine are caused by the entry of such impurities. Take particular care not to let any impurities get in when storing or adding oil.
- Never mix oils of different grades or brands.
- Always add the specified amount of oil.
Having too much oil or too little oil are both causes of problems.
- If the oil in the work equipment is not clear, there is probably water or air getting into the circuit. In such cases, please contact your Komatsu distributor.
- When changing the oil, always replace the related filters at the same time.
- We recommend you to have an analysis made of the oil periodically to check the condition of the machine. For those who wish to use this service, please contact your Komatsu distributor.

18.1.2 FUEL

- The fuel pump is a precision instrument, and if fuel containing water or dirt is used, it cannot work properly.
- Be extremely careful not to let impurities get in when storing or adding fuel.
- Always use the fuel specified in the Operation and Maintenance Manual.
Fuel may congeal depending on the temperature when it is used (Particularly in low temperature below-15°C), so it is necessary to change to a fuel that matches the temperature.
- To prevent the moisture in the air from condensing and forming water inside the fuel tank, always fill the fuel tank after completing the day's work.
- Before starting the engine, or when 10 minutes have passed after adding fuel, drain the sediment and water from the fuel tank.
- If the engine runs out of fuel, or if the filters have been replaced, it is necessary to bleed the air from the circuit.

18.1.3 COOLANT

- River water contains large amounts of calcium and other impurities, so if it is used, scale will form and build up in the engine and radiator, and this will prevent proper heat exchange and cause overheating. Do not use water that is not suitable for drinking.
- When using anti-freeze, always observe the precautions given in the Operation and Maintenance Manual.
- Komatsu machines are supplied with Komatsu original anti-freeze in the coolant when the machine is shipped.
This anti-freeze is effective in preventing corrosion of the cooling system.
The anti-freeze can be used continuously for two years or 4000 hours. Therefore, it can be used as it is even in hot areas.
- Anti-freeze is inflammable, so be extremely careful not to expose it to flame or fire.
- The proportion of anti-freeze to water differs according to the ambient temperature. For details of the mixing proportions, see 24.1.2 "CLEAN INSIDE OF COOLING SYSTEM."
- If the engine overheats, wait for the engine to cool before adding coolant.
- If the coolant level is low, it will cause overheating and will also cause problems with corrosion from the air in the coolant.

18.1.4 GREASE

- Grease is used to prevent twisting and noise at the joints.
- The nipples not included in the maintenance section are nipples for overhaul, so they do not need grease. If any part becomes stiff after being used for long time, add grease.
- Always wipe off all of the old grease that is pushed out when greasing. Be particularly careful to wipe off the old grease in places where sand or dirt sticking in the grease would cause wear of the rotating parts.

18.1.5 STORING OIL AND FUEL

- Keep indoors to prevent any water, dirt, or other impurities from getting in.
- When keeping drum cans for a long period, put the drum on its side so that the filler port of the drum can be at the side. (To prevent moisture from being sucked in)
If drum cans have to be stored outside, cover them with a waterproof sheet or take other measures to protect them.
- To prevent any change in quality during long-term storage, be sure to use in the order of first in first out (use the oldest oil or fuel first).

18.1.6 FILTERS

- Filters are extremely important safety parts. They prevent impurities in the fuel and air circuits from entering important equipment and causing problems.
Replace all filters periodically. For details, see the Operation and Maintenance Manual.
However, when working in severe conditions, it is necessary to consider replacing the filters at shorter intervals according to the oil and fuel (sulphur content) being used.
- Never try to clean the filters (cartridge type) and use them again. Always replace with new filters.
- When replacing oil filters, check if any metal particles are stuck to the old filter. If any metal particles are found, please contact your Komatsu distributor.
- Do not open packs of spare filters until just before they are to be used.
- Always use Komatsu genuine filters.

18.1.7 EXPLANATION OF LUBRICATION CHART DECAL

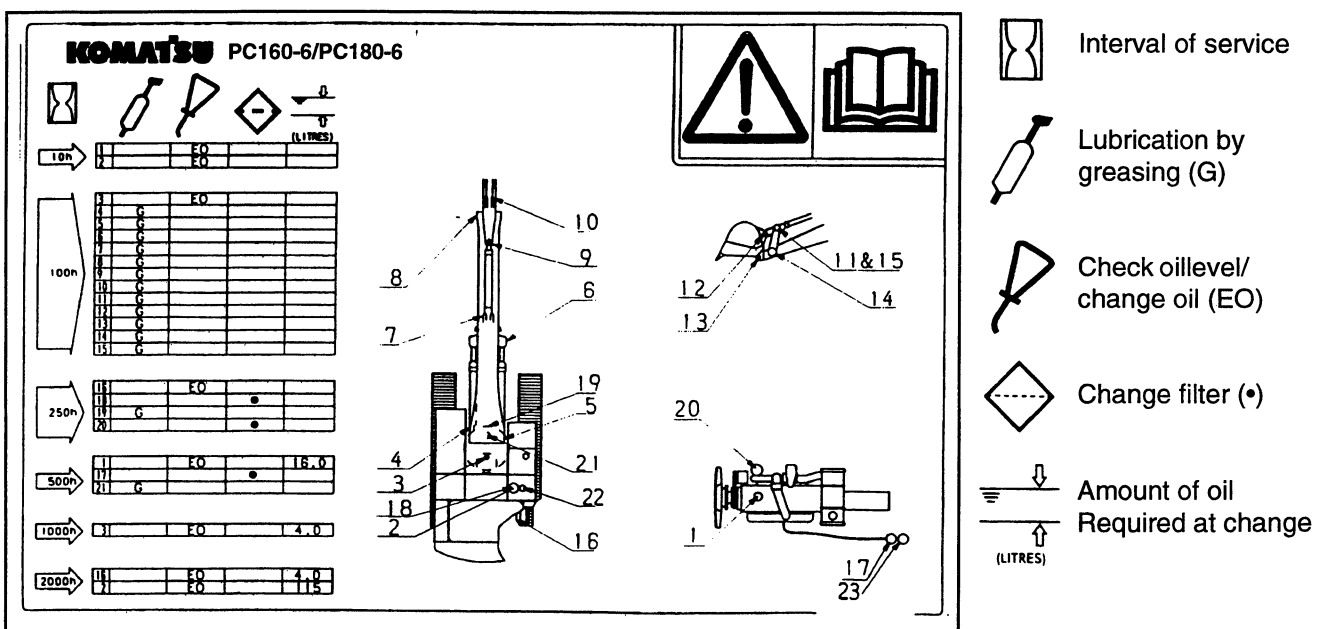

PC160/180/200-6K-ENG

KOMATSU PC200EL / 200EN- 6K

	1		EO		
100h	2		EO		

	3		EO		
100h	4	C			
	5	C			
	6	C			
	7	C			
	8	C			
	9	C			
	10	C			
	11	C			
	12	C			
	13	C			
	14	C			
	15	C			

	16		EO		
250h	18			•	
	19	G			
	20			•	

	1		EO		
500h	17			•	23.6
	21	G			

	3		EO		4.0
1000h	22		EO		0.75

	16		EO		4.0
2000h	2		EO		115

KEY TO LUBRICATION POINTS

- | | | | |
|------------------------------|---|---------------|-----------------|
| 1. Engine oil | : | Check level | refer to 24.2.2 |
| | | Change oil | refer to 24.3.3 |
| 2. Hydraulic oil | : | Check level | refer to 24.2.4 |
| | | Change oil | refer to 24.7.2 |
| 3. Swing machinery oil | : | Check level | refer to 24.3.2 |
| | | Change oil | refer to 24.6.1 |
| 4. Boom cylinder foot pin | : | Grease | refer to 24.3.1 |
| 5. Boom foot pin | : | Grease | refer to 24.3.1 |
| 6. Boom cylinder rod end | : | Grease | refer to 24.3.1 |
| 7. Arm cylinder foot pin | : | Grease | refer to 24.3.1 |
| 8. Boom arm coupling pin | : | Grease | refer to 24.3.1 |
| 9. Arm cylinder rod end | : | Grease | refer to 24.3.1 |
| 10. Bucket cylinder foot pin | : | Grease | refer to 24.3.1 |
| 11. Bucket cylinder rod end | : | Grease | refer to 24.3.1 |
| 12. Bucket-link coupling pin | : | Grease | refer to 24.3.1 |
| 13. Arm-bucket coupling pin | : | Grease | refer to 24.3.1 |
| 14. Arm link coupling pin | : | Grease | refer to 24.3.1 |
| 15. Link coupling pin | : | Grease | refer to 24.3.1 |
| 16. Final drive oil | : | Check level | refer to 24.4.1 |
| | | Change oil | refer to 24.7.1 |
| 17. Fuel water separator | : | Change filter | refer to 24.2.1 |
| 18. Hydraulic oil refill | : | Change filter | refer to 24.7.2 |
| 19. Swing circle | : | Lubricate | refer to 24.4.4 |
| 20. Engine oil filter | : | Change filter | refer to 24.5.3 |
| 21. Swing pinion | : | Lubricate | refer to 24.5.2 |
| 22. Hydraulic filter element | : | Change filter | refer to 24.4.3 |
| 23. Fuel filter | : | Change filter | refer to 24.5.1 |

18.2 OUTLINE OF ELECTRIC SYSTEM

- If the wiring gets wet or the insulation is damaged, the electric system may earth and could result in hazardous malfunction of the machine.
- Services relating to the electric system are (1) check of fan belt tension, (2) check of damage or wear in the fan belt and (3) check of battery fluid level.
- Never remove or disassemble any electric components installed in the machine.
- Never install any electric components other than these specified by Komatsu.
- Be careful to keep the electric system free of water when washing the machine or when it rains.
- Since the controller for the control system may cause malfunction due to external wave interference, before installing a radio receiver and a walkie-talkie or citizen band, consult your Komatsu distributor.
- When working on the seashore, carefully clean the electric system to prevent corrosion.
- When installing a car cooler or an other electrical equipment, connect it to an independent power source connector. The optional power source must never be connected to the fuse, starting switch, or battery relay.

18.3 OUTLINE OF HYDRAULIC SYSTEM

- During operation and immediately after operation is ended, the temperature of the hydraulic system still remains high.
In addition, high hydraulic pressure is applied to the system. Take care when inspecting and maintaining the hydraulic system.
 - Stop the machine on level ground, lower the bucket to the ground, then set so that there is no pressure applied to the cylinder circuit.
 - Always stop the engine.
 - Immediately after operations, the hydraulic oil and lubricating oil are at high temperature and high pressure, so wait for the oil temperature to go down before starting maintenance.
Even when the temperature goes down, the circuit may still be under internal pressure, so when loosening the plug or screw, or the hose joint, do not stand in front of the part. Loosen it slowly to release the internal pressure before removing it.
 - When carrying out inspection or maintenance of the hydraulic circuit, always bleed the air from the hydraulic tank to remove the internal pressure.
- Periodic maintenance includes the inspection of the hydraulic oil level, replacement of the filter and refilling of hydraulic oil.
When the high pressure hose, etc. is removed, check the O-ring for damage. If necessary, replace it.
- After the hydraulic filter element and strainer are cleaned or replaced, or after the hydraulic system is repaired or replaced or the hydraulic piping is removed, bleed air from the hydraulic circuit.
- The accumulators are charged with high-pressure nitrogen gas. Incorrect handling may be dangerous. For the handling procedure, see 11.19 "Handling the accumulator".

19. WEAR PARTS LIST

Wear parts such as filter elements are to be replaced at the time of periodic maintenance. The wear parts should be changed correctly in order to use the machine economically. For part change, use Komatsu genuine parts. When ordering parts, please check the part number in the parts book.

The parts in parentheses are to be replaced at the same time.

Item	Part No.	Part name	Q'ty	Replacement frequency
Hydraulic oil filter	07063-01100 (07000-05155)	Element (O-ring)	1 (1)	Every 250 hours service
Engine oil filter	6733-51-5140 (PC160/180) 6735-51-5140 (P200)	Cartridge	1	Every 500 hours service
Primary fuel filter	6732-71-6110	Cartridge	1	Every 500 hours service
Secondary water separator	6732-71-6310	Cartridge	1	Every 500 hours service
Hydraulic tank breather	20Y-60-21470	Element	1	Every 500 hours service
Air cleaner	203-01-K1130 203-01-K1290	Outer element Inner element	1 1	When required
Line filter	20E-62-K2960	Element	1 (2)	When required

20. USE FUEL, COOLANT AND LUBRICANTS ACCORDING TO AMBIENT TEMPERATURE

PROPER SELECTION OF FUEL, COOLANT AND LUBRICANTS

RESERVOIR	KIND OF FLUID	AMBIENT TEMPERATURE								CAPACITY	
		-22 -30	-4 -20	14 -10	32 0	50 10	68 20	86 30	104°F 40°C	Specified	Refill
Engine oil pan		SAE 30								16 ℓ (27ℓ)	16 ℓ (27ℓ)
		SAE 10W									
		SAE 10W-30									
		SAE 15W-40									
		SYNTHETIC 5W-30									
Swing machinery case									4 ℓ (4ℓ)	4 ℓ (4ℓ)	
Final drive case (each)	Engine oil	SAE 30								4 ℓ (4ℓ)	4 ℓ (4ℓ)
Hydraulic system		SAE 10W								190 ℓ (190ℓ)	135 ℓ (135ℓ)
		SAE 10W-30									
		SAE 15W-40									
Fuel tank	Dieselfuel	ASTM D975 No.2								250 ℓ (250ℓ)	-
		*									
All lubrication fittings	Grease	No. 2 Multi-Purpose lithium grease with 3% molybdenum disulfide									
Cooling system	Coolant	See Spectrum XXX, Komatsu Genuine Lubricants								20 ℓ (25 ℓ)	-

* ASTM D975 No. 1

() PC200EN/PC200EL

REMARK

- We recommend Komatsu genuine oil which has been specifically formulated and approved for use in engine and hydraulic work equipment applications.
- Only use high quality oils which meet internationally recognised specifications.
- When starting the engine in an atmospheric temperature of lower than 0°C, be sure to use engine oil of SAE10W, SAE10W-30 and SAE15W-40, even though an atmospheric temperature goes up to 10°C more or less in the day time.
- Use API classification CE or CF-4 as engine oil. If API classification CD is used reduce the engine oil change interval to half.
- There is no problem if single grade oil is mixed with multigrade oil (SAE10W-30, 15W-40), but be sure to add single grade oil that matches the temperature in the table.
- When fuel sulphur content is less than 0.5%, change oil in the oil pan every periodic maintenance hours described in this manual.
Change oil according to the following table if fuel sulphur content is above 0.5%.

Fuel sulphur content l	Change interval of oil in engine oil pan
0.5 to 1.0%	1/2 of regular interval
1.0% to 1.5%	1/4 of regular interval

Specified capacity: Total amount of oil including oil for components and oil in piping.

Refill capacity: Amount of oil needed to refill system during normal inspection and maintenance.

Abbreviations :

ASTM: American Society of Testing and Material

SAE: Society of Automotive Engineers

API: American Petroleum Institute

SPECTRUM XXX KOMATSU GENUINE LUBRICANTS			
			
TYPE	CLASS	VISCOSITY	REF.NO.
Engine oil	CF - 4	SAE15W - 40	EO - 1540
	CF - 4	SAE10W - 30	EO - 1030
TRANSMISSION OIL & GEAR BOX OIL	CD	SAE10W	TO - 10
	CD	SAE30	STO - 10 HEAVY DUTY
		SAE50	TO - 30
HYDRAULIC OIL	CD	SAE10W	TO - 50
BIO HYDRAULIC OIL		SAE10W	HO - 10
BIO GREASE			BO - 10
BIO GREASE			LG - N2
ANTI FREEZE			BIO - R2
BIO ANTI FREEZE			AF - 03
BIO ANTI FREEZE			BIO - AF - 0

21. STANDARD TIGHTENING TORQUES FOR BOLTS AND NUTS

21.1 INTRODUCTION OF NECESSARY TOOLS

The following tools are needed when carrying out maintenance. (These tools are provided in tool box)

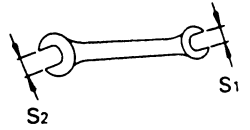
No.	Name of tool	Part No.	Remarks
1	Wrench	09002-01214 09002-01317 09002-01922 09002-02427 09002-03032	Applicable width across flats (S ¹ - S ²) 12 mm - 14 mm 13 mm - 17 mm 19 mm - 22 mm 24 mm - 27 mm 30 mm - 32 mm
			 <p style="text-align: right;">AD053370</p>
2	Screwdriver	09033-00190	Interchangeable flat-head and cross-head type
3	Socket wrench set	09020-10282	Applicable width across flats 10 mm, 13 mm, 14 mm, 17 mm, 19 mm, 22 mm, 24 mm, 27 mm, 30 mm, 32 mm. Extension, Handle, Joint, Ratchet handle bar
4	Wrench	09002-03641	Applicable width across flats 36 mm - 41 mm
5	Pliers	09036-00150	
6	Filter Wrench	09019-08035	
7	Grease Pump	07952-80003	For greasing work
9	Grease cartridge	07950-90403	(Lithium base grease, 400 g)
10	Hammer	09039-00150	
11	Pinch bar	09055-10390	
12	Gauge	09054-0009	
13	Hexagon wrench	09007-00836	Applicable width across flats 8mm

If any of the above tools are broken, please order them from your Komatsu distributor.

21.2 TORQUE LIST



Unless otherwise specified, tighten the metric bolts and nuts to the torque shown in the table.

The tightening torque is determined by the width across the flats of the nut and bolt.

If it is necessary to replace any nut or bolt, always use a Komatsu genuine part of the same size as the part that was replaced.

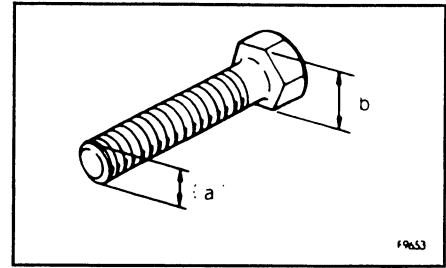
Nm (newton meter): 1 Nm \doteq 0.1 kgm
 \doteq 0.74 lbft



Thread diameter of bolt (mm) (a)	Width across flat (mm) (b)	 		
		Nm	kgm	lbft
6	10	13.2 ± 1.4	1.35 ± 0.15	9.73 ± 1.03
8	13	31.4 ± 2.9	3.2 ± 0.3	23.2 ± 2.1
10	16/17	65.7 ± 6.8	6.7 ± 0.7	48.5 ± 5.0
12	18/19	112 ± 9.8	11.5 ± 1.0	82.6 ± 7.2
14	21/22	177 ± 19	18.0 ± 2.0	131 ± 14
16	24	279 ± 29	28.5 ± 3	206 ± 21
18	27	383 ± 39	39 ± 3	282 ± 29
20	30	549 ± 58	56 ± 6	405 ± 43
22	32/34	745 ± 78	76 ± 8	549 ± 58
24	36	927 ± 98	94.5 ± 10	684 ± 72
27	41	1320 ± 140	135 ± 15	973 ± 100
30	46	1720 ± 190	175 ± 20	1270 ± 140
33	50	2210 ± 240	225 ± 25	1630 ± 180
36	55	2750 ± 290	280 ± 30	2030 ± 210
39	60	3280 ± 340	335 ± 35	2420 ± 250

NOTICE

When tightening panels or other parts having tightening fixtures made of plastic, be careful not to use excessive tightening torque: doing so will damage the plastic parts.

22. PERIODIC REPLACEMENT OF SAFETY CRITICAL PARTS

To ensure safety at all times when operating or driving the machine, the user of the machine must always carry out periodic maintenance. In addition, to further improve safety, the user should also carry out periodic replacement of the parts given in the table. These parts are particularly closely connected to safety and fire prevention.

With these parts, the material changes as time passed, or they easily wear or deteriorate. However, it is difficult to judge the condition of the parts simply by periodic maintenance, so they should always be replaced after a fixed time has passed, regardless of their condition. This is necessary to ensure that they always maintain their function completely.

However, if these parts show any abnormality before the replacement interval has passed, they should be repaired or replaced immediately.

If the hose clamps show any deterioration, such as deformation or cracking, replace the clamps at the same as the hoses.

When replacing the hoses, always replace the O-rings, gaskets, and other such parts at the same time. Ask your Komatsu distributor to replace the safety critical parts.

SAFETY CRITICAL PARTS PC160-6k/PC180-6k

No.	Safety critical parts for periodic replacement	Partnumber	Q'ty	Replacement interval
1	Fuel hose (fuel tank - water separator)	07288-11027	1	Every 2 years or 4000 hours, which ever comes sooner
2	Fuel hose (water separator - engine lift pump)	07288-11012	1	
3	Fuel hose (engine lift pump - fuel filter)	6733-71-6210	1	
4	Fuel tank (fuel filter - injection pump)	6733-71-6220	1	
5	Spill hose (engine - fuel tank)	07288-00828	1	
6	Hydraulic hose (main pump delivery)	21P-62-K2422	1	

SAFETY CRITICAL PARTS PC200-6k

No.	Safety critical parts for periodic replacement	Q'ty	Replacement interval
1	Fuel hose (fuel tank - sedimenter)	2	Every 2 years or 4000 hours, which ever comes sooner
2	Fuel hose (sedimenter - lift pump)	1	
3	Spill hose (engine - tank)	5	
4	Pump outlet hose (Pump to control valve)	2	

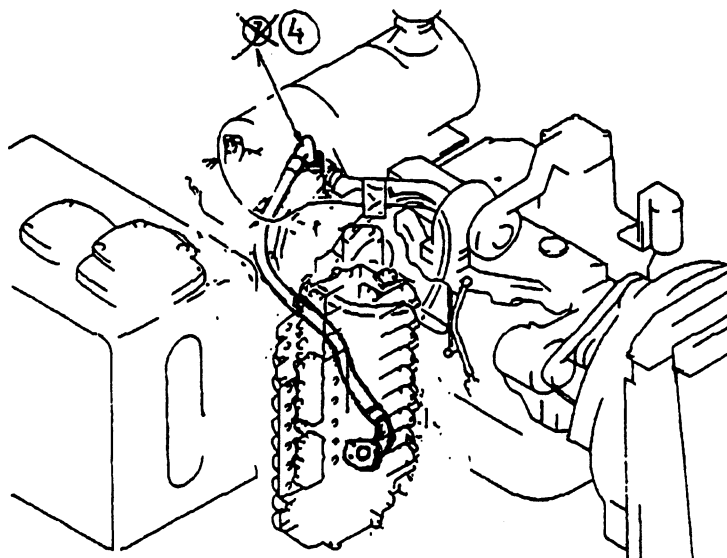
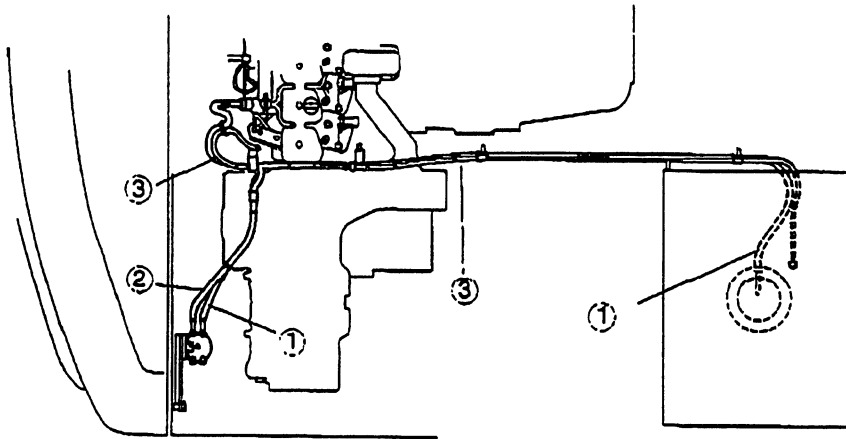

23. MAINTENANCE SCHEDULE CHART

23.1 MAINTENANCE SCHEDULE CHART

SERVICE ITEM	PAGE
WHEN REQUIRED	
Check, clean and replace air cleaner element	3-24
Clean inside of cooling system	3-26
Check and tighten track shoe bolts	3-32
Check and adjust track tension	3-33
Check electrical intake air heater	3-35
Replace bucket side cutters	3-36
Replace bucket teeth	3-36
Adjust bucket clearance	3-41
Check window washer fluid level, add fluid	3-42
Check and adjust air conditioner (Option)	3-43
Replace additional breaker filter element (option)	3-44
CHECK BEFORE STARTING	
Check coolant level, add water	3-45
Check oil level in engine oil pan, add oil	3-45
Check fuel level, add fuel	3-46
Check oil level in hydraulic tank, add oil	3-47
Check air cleaner for clogging	3-48
Check electric wirings	3-48
EVERY 100 HOURS SERVICE	
Lubricating	3-50
• Boom cylinder foot pin (2 points)	3-50

SERVICE ITEM	PAGE
Lubricating	
• Boom foot pin (2 points)	3-50
• Boom cylinder rod pin (2 points)	3-50
• Arm cylinder foot pin (1 point)	3-50
• Boom-arm coupling pin (1 point)	3-50
• Arm cylinder rod end (1 point)	3-50
• Bucket cylinder foot pin (1 point)	3-50
• Boom foot pin (2 points)	3-51
• Arm-link coupling pin (1 point)	3-51
• Arm-bucket coupling pin (1 point)	3-51
• Link coupling pin (2 point)	3-51
• Bucket cylinder rod end (1 point)	3-51
• Bucket-link coupling pin (2 points)	3-51
Check oil level in swing machinery case, add oil	3-51
Drain water and sediment from fuel tank	3-52
Clean fresh air intake heater filter	3-52
EVERY 250 HOURS SERVICE	
Check oil level in final drive case, add oil	3-53
Check level of battery electrolyte	3-54
Replace hydraulic filter element	3-55
Lubricate swing circle (2 points)	3-56
Check air conditioner compressor belt tension, adjust	3-57
EVERY 500 HOURS SERVICE	
Replace fuel cartridges	3-59
Check swing pinion grease level, add grease	3-61
Change oil in engine oil pan, replace engine oil filter cartridge	3-62
Clean and inspect radiator fins, oil cooler fins and condensor fins (only for machines equipped with air-conditioner)	3-64

23. MAINTENANCE SCHEDULE CHART

SERVICE ITEM	PAGE
(EVERY 500 HOURS SERVICE)	
Replace hydraulic tank breather element	3-64
EVERY 1000 HOURS SERVICE	
Change oil in swing machinery case	3-65
Check oil level in damper case, add oil	3-66
Check all tightening parts of turbocharger	3-66
Check play of turbocharger rotor	3-66
Check and adjust valve clearance (1 st 1000 hour only)	3-67
Check fan belt tensioner bearing, belt and fan hub	3-70
Check fan belt tension	3-71
EVERY 2000 HOURS SERVICE	
Check oil level in final drive case, add oil	3-72
Change oil in hydraulic tank, clean strainer	3-73
Clean, check turbocharger	3-78
Check alternator, starting motor	3-78
Check vibration damper	3-78
Change antifreeze	3-78
EVERY 4000 HOURS SERVICE	
Check water pump	3-79

23.2 MAINTENANCE WHEN USING HYDRAULIC BREAKER

For machines equipped with a hydraulic breaker, the hydraulic oil deteriorates faster than for normal bucket digging operations, so set the maintenance intervals as follows.

- Replacing hydraulic filter element
On new machines, replace the element after the first 100 to 150 hours, then carry out further replacement of the element according to the table on the right.
- Changing oil in hydraulic tank
Change the oil according to the table on the right.
- Replacing additional filter element for breaker
Use a guideline of 250 hours for use of the breaker operating ratio for the breaker: 50% or more) and replace the element according to the table on the right.

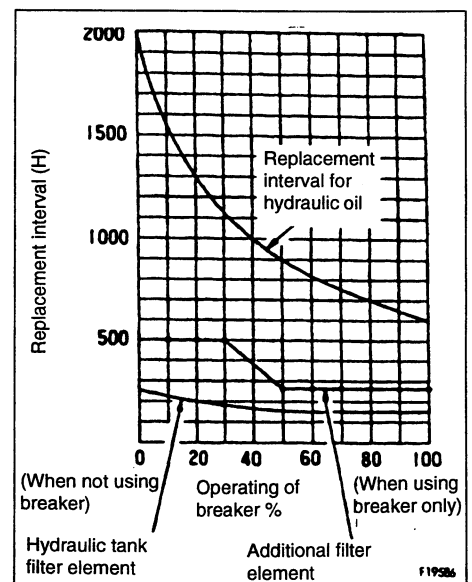

24. SERVICE PROCEDURE

24.1 WHEN REQUIRED

24.1.1 CHECK, CLEAN AND REPLACE THE AIR CLEANER ELEMENT

WARNING

- Never clean or replace the air cleaner element with the engine running.
- When using pressured air to clean the element, wear safety glasses or goggles to protect the eyes.

Checking

If air cleaner clogging monitor ① flashes, clean the air cleaner element.

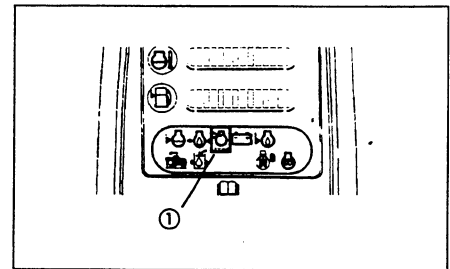

Cleaning or replacing the outer element

1. Open the machine door, loosen wing nut ②, then remove cover ⑥. Remove wing nut, then take out element ⑦.
2. To prevent dirt or dust from entering, use tape or a clean cloth to cover the inner element of the air cleaner body.
3. Clean the air cleaner body interior and the cover.
4. Direct dry compressed air (less than 700 kPa (7 kg/cm² , 100psi)) to element ⑦ from inside along its folds, then direct it from outside along its folds and again from inside.
 - 1) Remove one seal from the outer element whenever the outer element has been cleaned.
 - 2) Replace the outer element which has been cleaned 6 times repeatedly or used throughout a year. Replace the inner element at the same time.
 - 3) Replace both inner and outer elements when the monitor lamp ③ flashes soon after installing the cleaned outer element (even if it has not been cleaned 6 times).
 - 4) Check inner element mounting nuts for looseness and, if necessary, retighten.

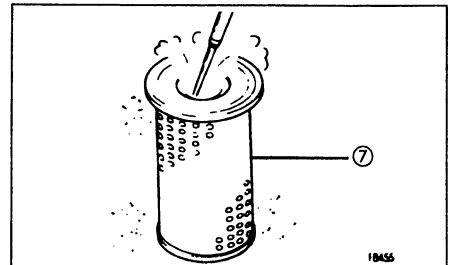
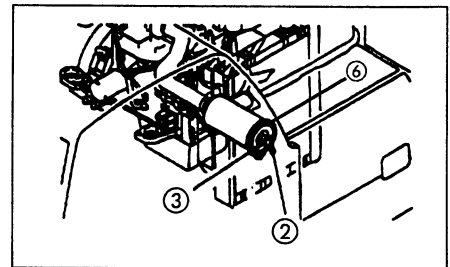

5. If small holes or thinner parts are found on the element when it is checked by shining a light through it after cleaning, replace the element.

NOTICE

Do not use an element whose folds or gasket or seal are damaged. When cleaning the element, do not hit it or beat it against anything. Wrap up unused elements and store them in a dry area.

6. Remove the cloth and tape used for cover in Step 1.
7. Install the cleaned element and fix it with the wing nut.
8. If seal washer ④ is damaged or the thread of wing nut ② is broken, replace it with a new part.
9. Remove vacuator valve ⑤ and clean with compressed air. After cleaning, install again.

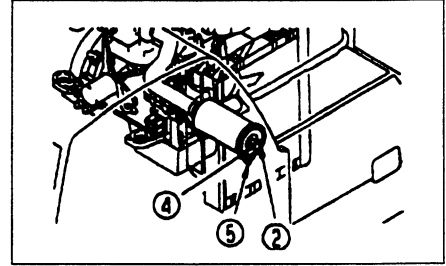
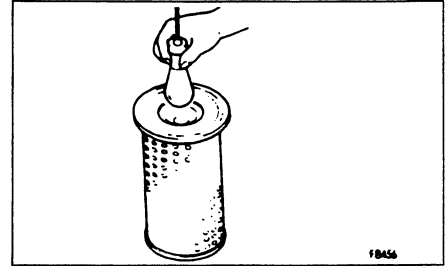

Replacing the inner element

1. Firsts remove the cover and the outer element, and then remove the inner element.
2. To prevent dust from getting in, use a clean cloth or tape to cover the air connector (outlet side).
3. Clean the air cleaner body interior, then remove the cover installed in Step 2.
4. Fit a new inner element to the connector and tighten it with the nuts. Do not clean and reinstall a inner element.
5. Install the outer element and fix it with the wing nut.

24.1.2 CLEAN INSIDE OF COOLING SYSTEM

 **WARNING**

- **Soon after the engine has been stopped, the coolant is hot and can cause personal injury. Allow the engine to cool before draining water.**
- **Since cleaning is performed while the engine is running, it is very dangerous to enter the rear side of the machine as the machine may suddenly start moving. If the under cover is left removed, it may interfere with the fan. While the engine is running, never enter the rearside of the machine.**
- **Never remove the radiator cap when the engine is at operating temperature. At operating temperature, the coolant is under pressure. Steam blowing up from the radiator could cause personal injury. Allow the engine to cool until the radiator filler cap is cool enough to touch with your hand. Remove the filler cap slowly to allow pressure to be relieved.**

GENERAL

The cooling system operates under pressure which is controlled by the pressure relief valve in the radiator cap.

The belt-driven water pump circulates the coolant through the engine block, cylinder heads, radiator and engine oil cooler. Circulation is controlled by the thermostat which by-passes coolant flow around the radiator until the engine reaches operating temperature.

Proper cooling is possible only when the system is sealed, the radiator cap gasket is in good condition, the pressure relief valve and thermostat are operating properly. The system is free of coolant and air flow restrictions and the system is filled to the proper level.

Selection and maintenance of the engine coolant is important to long engine life. The following information provides recommendations for selecting the engine coolant, maintaining the coolant inhibitors and servicing the cooling system.

The system operates successfully with a water/antifreeze mixture or inhibited/conditioned water as the coolant. Water alone allows rust, scale deposits, and corrosion to occur within the system.

After 4,000 hours or two years of operation, whichever comes first, the cooling system should be drained, flushed, and refilled as described in this section.

- When deciding the ratio of antifreeze to water, check the lowest temperature in the past, and decide from the mixing rate table given below.
It is actually better to estimate a temperature about 10°C lower when deciding the mixing rate.

**Mixing rat of water and antifreeze
(For PC160, PC180)**

Min. atmospheric temperature	°C	-5	-10	-15	-20	-25	-30
	°F	23	14	5	-4	-13	-22
Amount of antifreeze	ℓ	4.6	6.0	7.2	8.2	9.2	9.95
Amount of water	ℓ	15.4	14.0	12.8	11.8	10.8	10.05

(For PC200)

Min. atmospheric temperature	°C	-5	-10	-15	-20	-25	-30
	°F	23	14	5	-4	-13	-22
Amount of antifreeze	ℓ	5.8	7.6	9.1	10.3	11.6	12.6
Amount of water	ℓ	19.3	17.5	16.0	14.8	13.5	12.5

⚠ WARNING

Antifreeze is flammable, so keep it away from any flame.

- Use city water for the cooling water.
If river water, well water or other such water supply must be used, contact your Komatsu distributor.
- We recommend use of an antifreeze density gauge to control the mixing proportions.

⚠ WARNING

When removing drain plug, avoid pouring coolant on yourself.

REMOVAL

WARNING

- Hot, scalding coolant can spray out if the radiator cap is removed suddenly. Relieve system pressure by slowly turning the cap to the first notch or lifting the safety lever (if equipped). Remove the cap only after the pressure is relieved.
- Use extreme caution when adding coolant to the radiator to avoid being burned. Wear gloves and goggles and keep face away from the filler neck.

To remove the cap, turn the cap to the left, or counterclockwise up to the safety stop until the cap is free to be removed.

INSTALLATION

When installing the cap, the gasket and contacting surfaces must be clean. Turn the cap to the right, or clockwise until snug.

24.1.3 CHECKING COOLANT LEVEL

REMARK: Check the coolant level before starting the engine.

1. Check the coolant level in the radiator reserve tank (5). The coolant level should be between the **FULL** and **LOW** markings on the tank.
2. If coolant must be added, remove the reserve tank cap (4) and add coolant until level is between the **FULL** and **LOW** markings on the tank.

24.1.4 DRAINING THE SYSTEM

WARNING

- Before working on the engine or electrical system, disconnect the negative (ground) battery cable. Tag the cable and controls to warn against starting.
- Wear hand and eye protection when draining hot fluids.

1. Run the engine until it reaches operating temperature; then stop the engine
2. Remove the radiator cap as outlined in this section.
3. Remove the crankcase coolant drain plug located on the bottom of the coolant inlet.
4. Open the radiator drain valve.

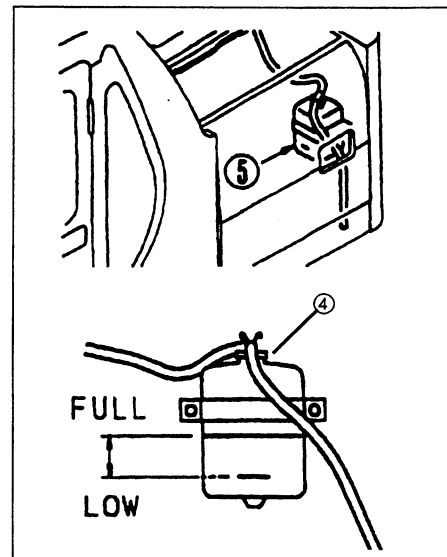

5. Open the cap water heater valves, if equipped.
6. Allow the system to completely drain into a suitable container.
Do not let drain outlets plug up during draining.
7. Close the radiator drain valve. Install the crankcase coolant drain plug.
8. Close the cap heater water valves, if equipped.

24.1.5 CLEANING THE SYSTEM

At 4,000 hours or after two years of service, whichever comes first, clean the cooling system as follows:

1. Drain the system into a suitable container. Refer to "DRAINING THE SYSTEM".
2. Drain and clean the reserve tank.
3. Close the radiator and crankcase drains.

REMARK: Be sure to close the cab heater water valves, if equipped, before any flushing compounds are circulated through the cooling system. This is to prevent particles of corrosion normally loosened by flushing compound, from plugging the small passages of the heater core.

4. Fill the system with clean water, refer to "FILLING THE SYSTEM" and add a flushing compound that is compatible with aluminium. Flush the system in accordance with the instructions furnished with the compound.
5. After flushing, rinsing and completely draining the system, open the cab heater water valves, if equipped. Refill with clean coolant. Refer to "FILLING THE SYSTEM".

24.1.6 FILLING THE SYSTEM

REMARK: Be sure to fill the heater and heater supply lines with fresh coolant, even if the heater is not in use (warm weather). Leaving the heater core empty causes corrosion in the heater.

1. Be sure the radiator drain valve and crankcase drain plugs are closed and tightened. Open the cab heater water valves, if equipped.
2. Fill the cooling system to maximum capacity. Fill with antifreeze and change the coolant filter.
3. Open the after-cooler air drain valves ④ and add coolant until it overflows from the water filler. When the coolant comes up to near the water filler port, close the after-cooler air drain valve. For coolant specifications → SEE "20 COOLANT SYSTEM" on page 3-12.
4. Start engine and run until normal operating temperature is reached. Add coolant when needed to keep proper level in reserve tank.
5. After all air is removed and level remains fixed, install the radiator cap.
6. Fill the radiator reserve tank with coolant until level is between the FULL and LOW markings on the tank.

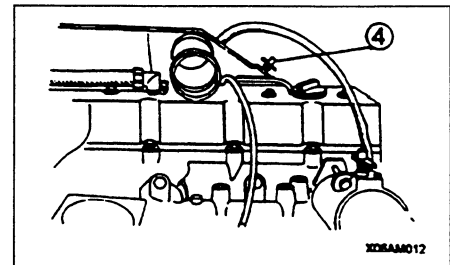

24.1.7 REFILLING AN OVERHEATED SYSTEM

Do not add coolant to the radiator of an overheated engine unless absolutely necessary. However, if necessary:

1. Remove the radiator cap. Refer to "RADIATOR CAP" in this section.
2. Be sure all the drains are closed.

 **WARNING**

Use extreme caution when adding coolant to a hot radiator to avoid being burned. Wear gloves and goggles and keep away from the filler neck.

3. Add coolant to the radiator slowly until full.
4. Remove the reserve tank cap.
5. Add coolant to the reserve tank until the level is between FULL and LOW marking on the tank.
6. When coolant level remains fixed between the FULL and LOW on the reserve tank, install the reserve tank cap.
7. Run the engine
8. Stop the engine
9. Check for leaks and coolant level in the reserve tank.

24.1.8 CLEANING THE RADIATOR

Minor internal sludge accumulations will be removed when flushing the cooling system.

When internal accumulations are found that cannot be removed by normal flushing methods, consult your distributor.

Remove all bugs and dirt from the radiator core, using air or water under pressure. Direct the flow through the core, opposite to the normal direction of air flow.

24.1.9 CLEANING THE RADIATOR PRE-SCREEN

1. Remove the bolts retaining the radiator pre-screen and remove the pre-screen.
2. Clean the pre-screen with water under pressure.
3. Reinstall the pre-screen and retaining bolts.

24.1.10 THERMOSTATS

REMOVAL

1. Drain the cooling system. Refer to "DRAINING THE SYSTEM" in this section.
2. Remove the components and housing to access the thermostats a.
3. Remove the thermostats and clean all gasket material from either mating surfaces.

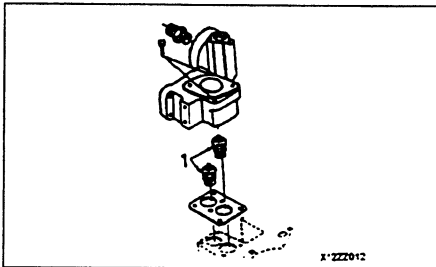

INSTALLATION

1. Install two new thermostats with new gasket.
2. Re-install thermostat housing and all component parts.
3. Fill the cooling system. Refer to "COOLING THE SYSTEM" in this section.

24.1.11 FAN

WARNING

Personal injury can result from a fan blade failure. Never pull or pry on the fan. This can damage the fan blade(s) and cause fan failure.

Check the fan for cracks, loose rivets (for metal fans) and bent or loose blades. Make sure it is securely mounted. Tighten the capscrews if loose. Replace damaged fans.

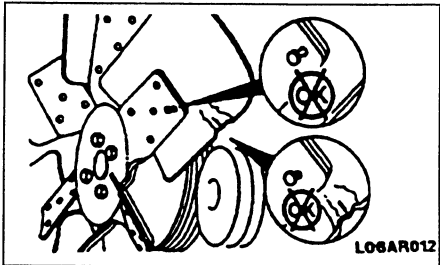

24.1.12 CHECK AND TIGHTEN TRACK SHOE BOLTS

If the machine is used with track shoe bolts ① loose, they will break, so tighten any loose bolts immediately.

Method for tightening

1. Tighten first to a tightening torque of $390 \pm 40 \text{ Nm}$ ($40 \pm 4 \text{ kgm}$, $290 \pm 30 \text{ lb ft}$), then check that the nut and shoe are in close contact with the link mating surface.
2. After checking, tighten a further $120^\circ \pm 10^\circ$.

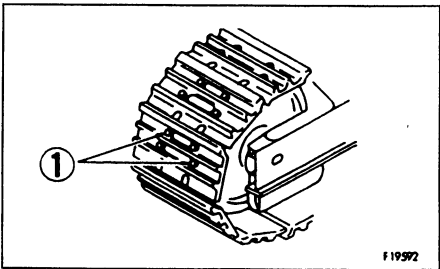

Order for tightening

Tighten the bolts in the order shown in the diagram. After tightening, check that the nut and shoe are in close contact with the link mating surface.

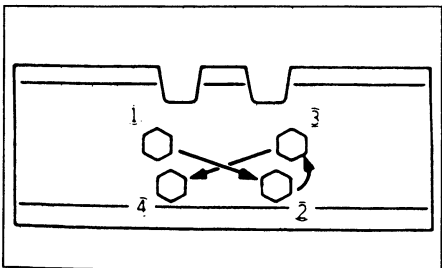

24.1.13 CHECK AND ADJUST TRACK TENSION

⚠ WARNING

Carry out this operation with two workers. The operator must move the machine in accordance with the signals from the other worker. The track tension is checked with the chassis raised, so it extremely dangerous if the machine is lowered by mistake during the inspection. Never move the machine while anyone is carrying out measurements.

The wear of pins and bushings on the undercarriage will vary with the working conditions and soil properties. It is thus necessary to continually inspect the track tension so as to maintain the standard tension.

Carry out the check and adjustment under the same conditions as when operating (on jobsites where the track becomes clogged with mud, measure with the track clogged with mud).

Inspection

1. Raise the chassis with the boom and arm. When doing this, operate the levers slowly.
2. Measure the clearance between the bottom of the track frame and the top of the track shoe at a position that is safe even if the chassis should come down

Standard clearance: ± 20 mm. (13.0 \pm 0.8 in)

- * Places to measure
4th track roller from sprocket.

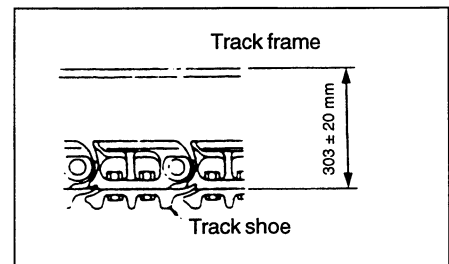
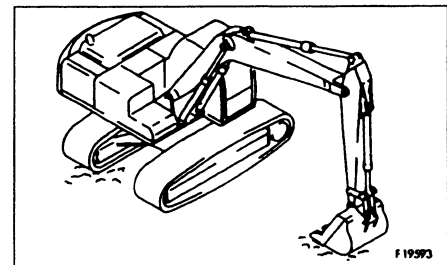

If the track tension is not the standard value, adjust in the following manner.

Adjustment

⚠ WARNING

Grease inside the adjusting mechanism is under high pressure. Grease coming from plug under pressure can penetrate the body causing injury or death. For this reason, do not loosen any part other than the plug more than one turn. Do not put your face in front of the plug ①. If the track tension is not relieved by this procedure, please contact your Komatsu distributor.

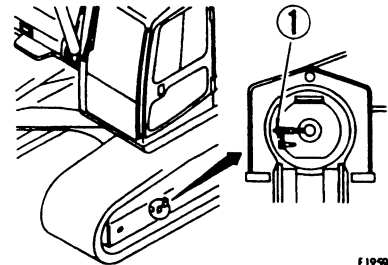

When increasing tension

Prepare a grease gun.

1. Pump in grease through grease fitting ② with a grease gun.
2. To check that the correct tension has been achieved, move the machine backwards and forwards.
3. Check the track tension again, and if the tension is not correct, adjust it again.
4. Continue to pump in grease until S becomes 0 mm. If the tension is still loose, the pin and bushing are excessively worn, so they must be either turned or replaced. Please contact your Komatsu distributor

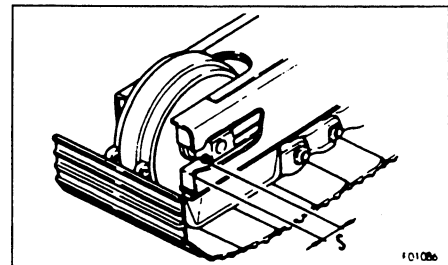
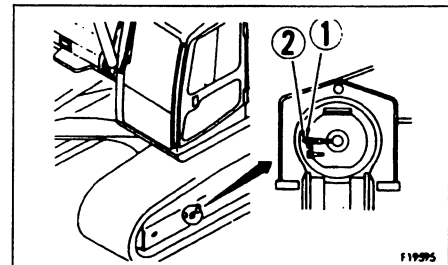

When loosening tension.

⚠ WARNING

It is extremely dangerous to release the grease by any method except the procedure given below. If the track tension is not relieved by this procedure, please contact your komatsu distributor.

1. Loosen plug ① gradually to release the grease.
2. Turn plug ① a maximum of one turn.
3. If the grease does not come out smoothly, move the machine backwards and forwards a short distance.
4. Tighten plug ①
5. To check that the correct tension has been achieved, move the machine backwards and forwards.
6. Check the track tension again., and if the tension is not correct, adjust it again.

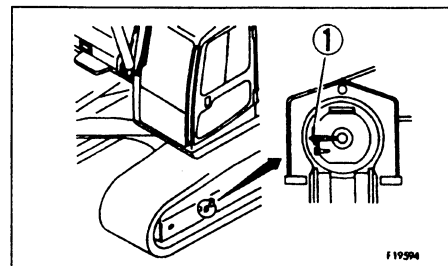

24.1.14 CHECK ELECTRICAL INTAKE AIR HEATER

Before the start of the cold season (once a year), contact your Komatsu distributor to have the electrical intake air heater repaired or checked for dirt or disconnections.

24.1.15 CHECK ALTERNATOR

GENERAL

The alternator requires no lubrication since its bearings are factory lubricated for life and require attention only at the time of major overhaul.

The alternator is equipped with an integral, transistorized voltage regulator. If the alternator fails to operate properly, consult your distributor.

PRECAUTIONS

NOTICE:

The unit electrical system is negative ground. Be CERTAIN the ground polarity is correct when:

- a. **Installing a new battery.**
- b. **Connecting a battery charger.**
- c. **Using a booster.**

Failure to observe proper polarity will result in damage to the alternator.

NEVER use a fast charger as a booster to start the engine.

NEVER unhook a battery terminal while the engine is running.

NEVER disconnect the alternator cable while the engine is running.

NOTICE: Do not short across or ground any terminals of the alternator. Do not connect any cable to the "R" terminal on the alternator. This will result in severe damage to the harness and radiator.

24.1.16 CHECK START MOTOR

Under normal operating conditions, no maintenance is required between engine overhaul periods. At the time of engine overhaul, the motor should be disassembled, inspected, cleaned and tested. Contact your distributor for detailed information.

24.1.17 REPLACE BUCKET SIDE CUTTERS

⚠ WARNING

It is dangerous if the work equipment moves by mistake when the teeth are being replaced. Set the work equipment in a stable condition, then stop the engine and apply the locks securely to the levers.

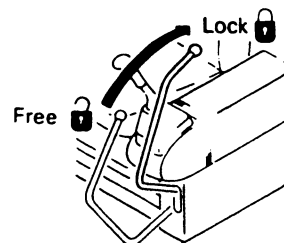

1. Untighten nuts ⑤ and bolts ③ and remove side cutters ① and ②.
2. Clean cutter mounting face on bucket side plate.
3. Check nuts and bolts and replace if damaged.
4. Fit new side cutters.
5. Tighten bolts to 110 ± 10 kgm.

NOTICE

When side cutters are not being used shrouds ⑥ should be fitted to prevent wear of the bucket side plate.

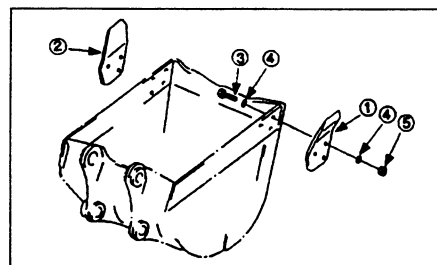

24.1.18 REMOVAL OF BUCKET TEETH (ESCO VERTALOK® TYPE)

Replace the point before the adapter starts to wear.

WARNING

It is dangerous if the work equipment moves by mistake when the teeth are being replaced.
Set the work equipment in a stable conditions, then stop the engine and apply the safety lock lever securely.

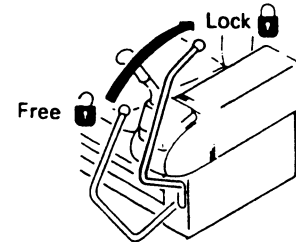

- Place a block under the bottom of the bucket to allow the pin to be knocked out with a hammer. Carry out full stroke operation of the control levers within 15 seconds after stopping the engine. After confirming that the work equipment is in a stable condition, lock the safety lock lever.
Set so that the bottom face of the bucket is horizontal.

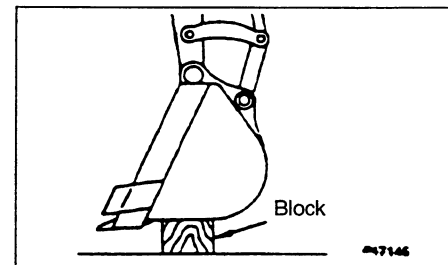

WARNING

- When installing Vertalok® teeth, always work safely and use proper equipment to avoid injury. Wear OSHA-approved hard hat, safety glasses, gloves, and steeltoed shoes. Be sure other people are out of the way; only one person is needed to install Vertalok® points.
- All struck tools or punches should have a bevel or radius around the striking face that is equal to 1/10th the width of the striking face.
- The rubber plug should be removed prior to any heating or welding near the Vertalok® nose or adapter.

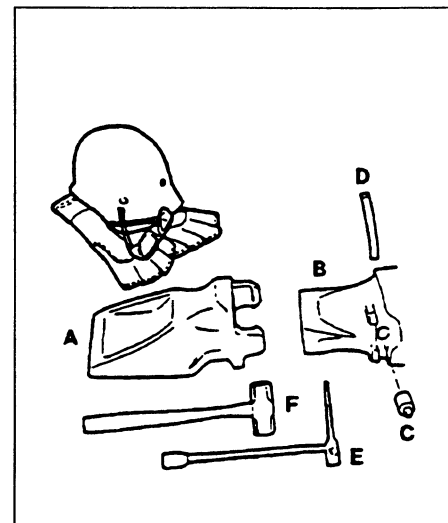

24. SERVICE PROCEDURE

2. The Helilok® point (A) twists onto the adapter (B) and is secured by the plug (C), which is inserted into the side of the adapter, and the pin (D) which is driven in from the top. The recommended tools for installation and removal are a Removal Tool (E) and a 1 to 2 kg (2 to 4 lb.) hammer (F).

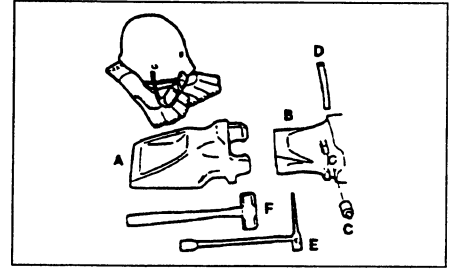

3. Place the small end of the Removal Tool on top of the pin and start the drive with the hammer. It may take a few solid blows.

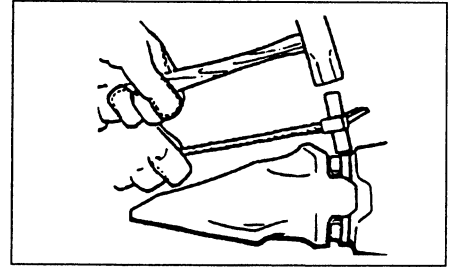

4. Complete the drive with the long end of the Removal Tool until the pin comes out the bottom. When removing the Tool from the groove, be careful not to dislodge the point.

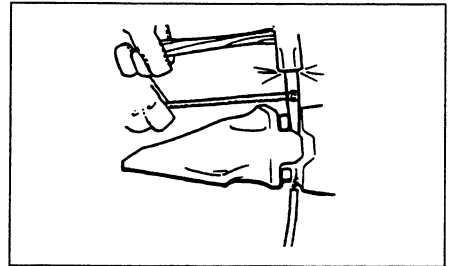

5. Remove the point by twisting counterclockwise. Make sure the plug is fully seated so the point may require several blows with the hammer to loosen any impacted fines.

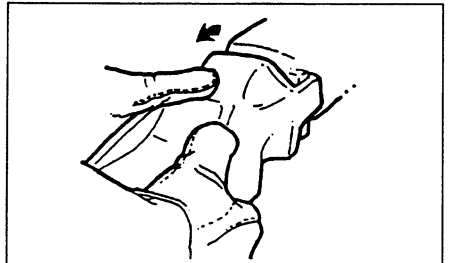

24.1.19 INSTALLATION OF BUCKET TEETH (ESCO VERTALOK® TYPE)

⚠ WARNING

It is dangerous if the work equipment moves by mistake when the teeth are being replaced. Set the work equipment in a stable condition, then stop the engine and apply the safety lock lever securely.

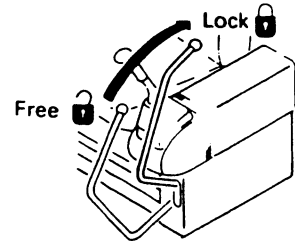

1. Place a block under the bottom of the bucket. Carry out full stroke operation of the control levers within 15 seconds after stopping the engine. After confirming that the work equipment is in a stable condition, lock the safety lock lever. Set so that the bottom face of the bucket is horizontal.

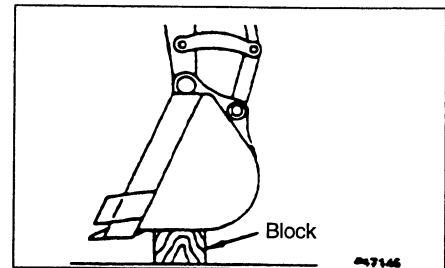

⚠ WARNING

- When installing Vertalok® teeth, always work safely and use proper equipment to avoid injury. Wear OSHA-approved hard hat, safety glasses, gloves, and steeltoad shoes. Be sure other people are out of the way; only one person is needed to install Vertalok® points.
- All struck tools or punches should have a bevel or radius around the striking face that is equal to 1/10th the width of the striking face.
- The rubber plug should be removed prior to any heating or welding near the Vertalok® nose or adapter.

2. The Helilok® point (A) twists onto the adapter (B) and is secured by the plug (C), which is inserted into the side of the adapter, and the pin (D), which is driven in from the top. The recommended tools for installation and removal are a Removal Tool (E) and a 1 to 2 kg (2 to 4 lb.) hammer (F).

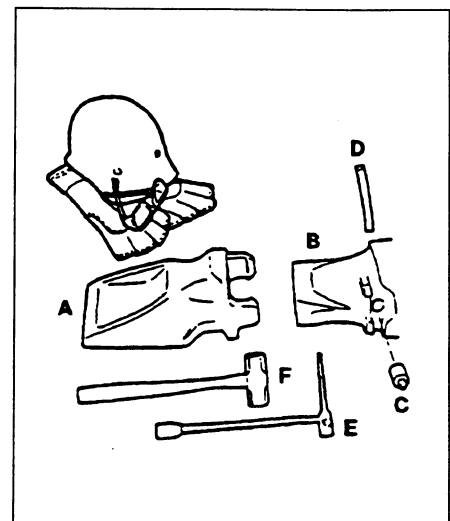

24. SERVICE PROCEDURE

- Clean the adapter nose to make sure the point will fully seat.

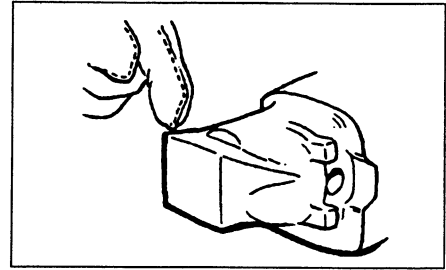

- Check the plug for torn, cracked or separated rubber when reusing any plug.

NOTICE

Plugs for Hot Slag points are not encased in rubber.

Replace the plug if damage is discovered. With fines removed from the hole, insert the plug, making sure it seats fully on the bottom of the hole. The shoulder of the plug should be no deeper than 3.2 mm (1/8 in)

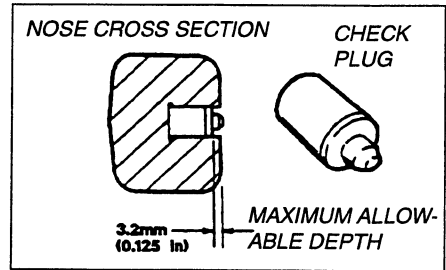

- Twist the point on with a quarter turn to connect to the end of the end of the adapter nose. Check the lock groove to be sure the plug remains fully seated.

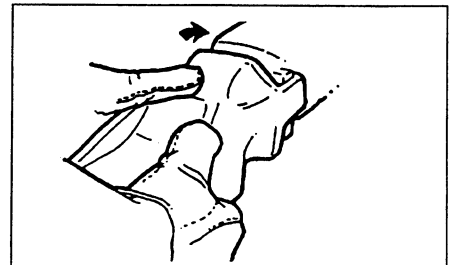

- Inspect the top of the pin. It should be free of sharp edges due to wear or peening. If there are sharp edges, replace the pin. Insert the pin with the bevel down and the recess to the inside so the recess can engage the plug tip.

NOTICE

The pin is marked with an arrow which must point downward.

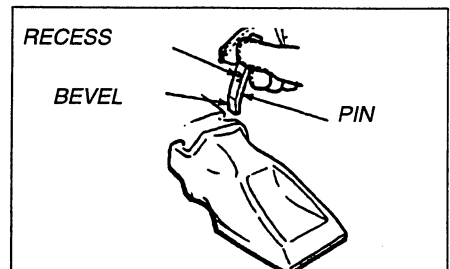

- Start the pin with a swift, sharp blow with the hammer. If the pin becomes crooked after the first blow, straighten it before proceeding. Drive the pin in until the top is flush with the top of the upper pin retaining ear located on the adapter nose.

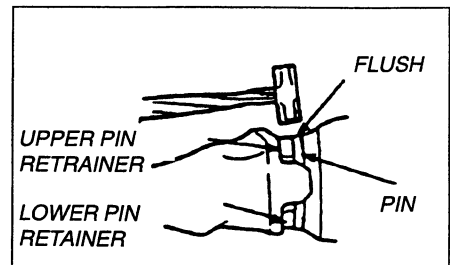

24.1.20 ADJUST BUCKET CLEARANCE

⚠ WARNING

It is dangerous if the work equipment moves by mistake when the clearance is being adjusted. Set the work equipment in a stable condition, then stop the engine and lock the lever securely.

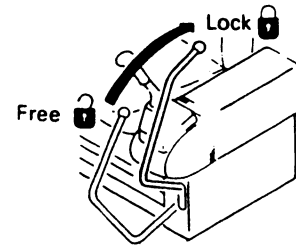
**⚠ WARNING**

- When knocking the pin in with a hammer, metal particles may fly and cause serious injury, particularly if they get into your eyes. When carrying out this operation, always wear goggles, helmet, gloves, and other protective equipment.
- When the bucket is removed, place it in a stable condition.

1. Set the work equipment to the position shown in the diagram at right, stop the engine and set the safety lock lever to the lock position.
2. Measure the amount of play Ⓐ .
Measurement is easier if you move the bucket to one side or the other so all the play can be measured in one place.
(In the diagram this is on the left-hand side)
Use a gap (clearance) gauge for easy and accurate measurement.

REMARK

When removing the pins, place the bucket so that it is in light contact with the ground.

If the bucket is lowered strongly to the ground, the resistance will be increased and it will be difficult to remove the pins.

3. Remove the stopper bolt Ⓐ and nut and remove the pin half way.
4. Fit shims Ⓑ according to the amount of free play Ⓐ measured above

(EXAMPLE)

If the play is 3 mm, fit two 1.0 mm shims and one 0.5 mm shim and the play will become 0.5 mm.

When the play Ⓐ is smaller than 0.5 mm. Do not carry out any maintenance.

5. Refit pin and stopper bolt.

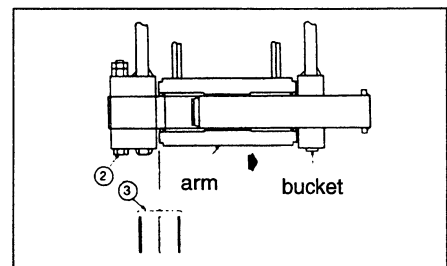
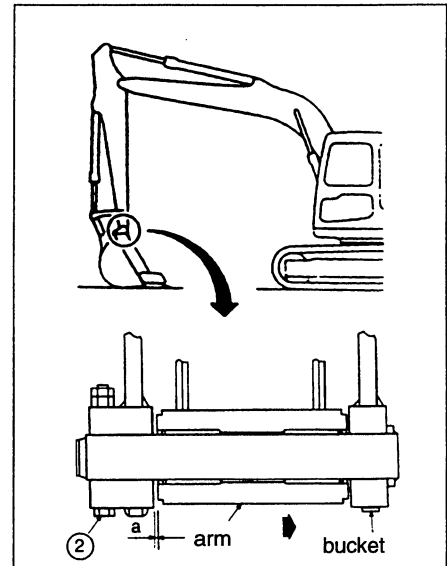

24.1.21 CHECK WINDOW WASHER FLUID LEVEL, ADD FLUID

If air is ejected with the window washer fluid, check the fluid level in window washer tank ①. If showing under the level, fill with automobile window washer fluid.

When adding fluid, be careful not to let dirt or dust get in.

- Mixture ratio of pure washer fluid and water
Since the ratio should be varied depending on atmospheric temperature, replenish washer fluid at the following mixture ratio, taking temperature into account.

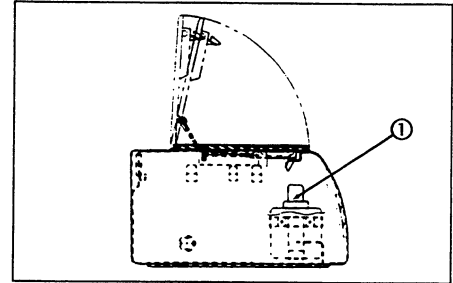

Operation area and season	Mixture ratio	Freezing temperature
Normal	Pure washer fluid 1/3: water 2/3	- 10° C (14°F)
Winter in cold region	Pure washer fluid 1/2: water 1/2	- 20°C (- 4°F)
Winter in extremely cold region	Pure washer fluid	- 30°C (- 22°F)

Pure washer fluid comes in two types: for -10°C(14°F) (for general use) and for -30°C (-22°F) (cold regions).
Use pure washer fluid according to operation area and season.

24.1.22 CHECK AND ADJUST AIR CONDITIONER

CHECK LEVEL OF REFRIGERANT (GAS)

⚠ WARNING

If the liquid get into your eyes or on your hands, it may cause loss of sight or frostbite, so never loosen any part of the refrigerant circuit.

The air conditioning system is equipped with pressure switches which disable the system if the pressure is too high or low, to prevent damage to the system.

If the air conditioner fails to operate it may be due to:

- a) Low pressure
 - i) Check for leaks.
 - ii) Consult your distributor to recharge system.
- b) High pressure
 - i) Check for blockages in piping.

Check in off-season

When not being used for a long period, operate the cooler for 3 to 5 minutes once a month to supply lubricant to each component of the compressor.

Inspection and maintenance items list for cooler

Inspection and maintenance items	Contents	Maintenance interval
Refrigerant (gas)	Filling quantity	Twice a year; spring and autumn
Condenser	Clogging of fin	Every 500 hours
Compressor	Function	Every 4000 hours
V belt	Damage and tension	Every 250 hours
Blower motor and fan	Function (Check for normal sound)	When required
Control mechanism	Function (Check for function)	When required
Piping for connection	Installation condition looseness of tightening connection portion gas leakage, damage	When required

24.1.23 MAINTENANCE WHEN USING HYDRAULIC BREAKER

For machines equipped with a hydraulic breaker, the hydraulic oil deteriorates faster than for normal bucket digging operations, so set the maintenance intervals as follows.

- Replacing hydraulic filter element**
 On new machines, replace the element after the first 100 to 150 hours, then carry out further replacement of the element according to the table on the right.
- Changing oil in hydraulic tank**
 Change the oil according to the table on the right.

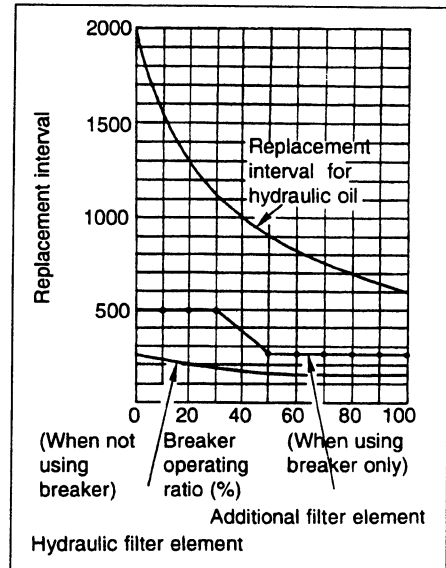

24.2 CHECK BEFORE STARTING

24.2.1 CHECK COOLANT LEVEL, ADD WATER

⚠ WARNING

Do not open the radiator cap unless necessary. When checking the coolant, always check the radiator reserve tank when the engine is cold.

1. Open the rear door on the left side of the machine and check that the cooling water level is between the FULL and LOW marks on radiator reserve tank ① (shown in the diagram on the right). If the water level is low, add water through the water filler of reserve tank ① to the FULL level.
2. After adding water, tighten the cap securely.
3. If the reserve becomes empty, first inspect for water leaks and then fill the radiator and the reserve tank with water.

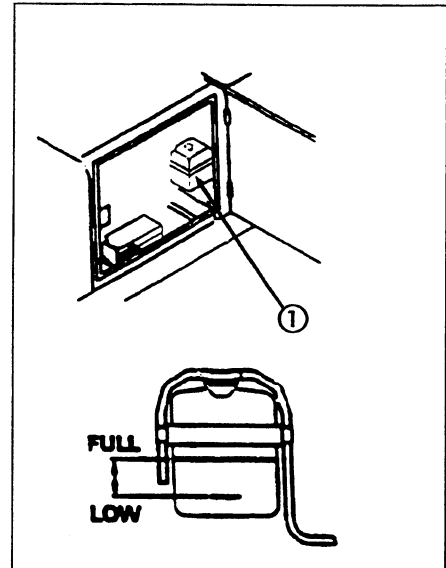

24.2.2 CHECK OIL LEVEL IN ENGINE OIL PAN, ADD OIL

1. Open the engine hood.
2. Remove dipstick ③ and wipe the oil off with a cloth.
3. Insert dipstick ③ fully in the oil gauge pipe, then take it out again.
4. The oil level should be between the H and L marks on dipstick ③. If the oil level is below the L mark, add engine oil through oil filler ②.

For details of the oil to use, see 20. "USE OF FUEL, COOLANT AND LUBRICANTS ACCORDING TO AMBIENT TEMPERATURE".

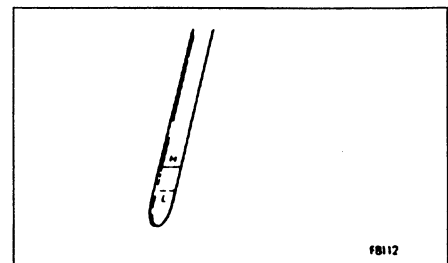
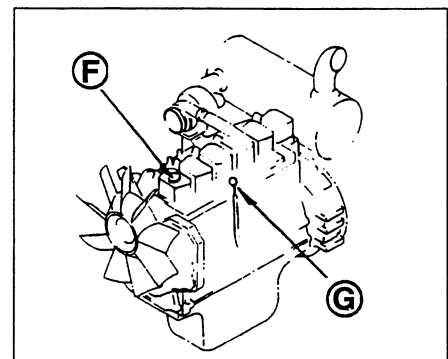

F8112

24. SERVICE PROCEDURE

5. If the oil is above the H mark, drain the excess engine oil using drain plug in the bottom of oil pan, and check the oil level again.
6. If the oil level is correct, tighten the oil filler cap securely and close the engine hood.



REMARK

When checking the oil level after the engine has been operated wait for at least 15 minutes after stopping the engine before checking. If the machine is at an angle, make it horizontal before checking.

24.2.3 CHECK FUEL LEVEL, ADD FUEL

WARNING

When adding fuel, never let the fuel overflow. This may cause a fire. If spilling fuel, thoroughly clean up any spillage.

1. Use sight gauge  on the rear face of the fuel tank to check that the tank is full.
2. If the fuel level is not within the sight gauge, add fuel through filler port , while watching sight gauge .

Fuel capacity: 250 (66 US gal, 55 UK gal)

For details of the fuel to use, see 20. "USE OF FUEL, COOLANT AND LUBRICANTS ACCORDING TO AMBIENT TEMPERATURE".

3. After adding fuel, tighten the cap securely.

NOTE:

To prevent moisture due to condensation, the fuel tank must be filled at the end of each day's operation.

REMARK

If breather holes  on the cap is clogged, the pressure in the tank will drop and fuel will not flow. Clean the holes from time to time.

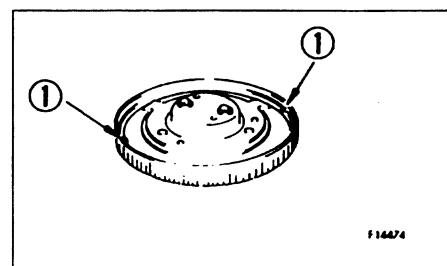
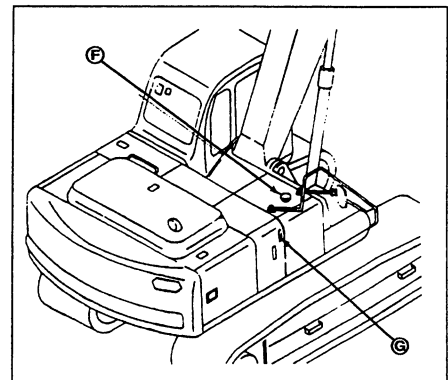

24.2.4 CHECK OIL LEVEL IN HYDRAULIC TANK, ADD OIL

WARNING

- When removing the oil filler cap, oil may spurt out, so turn the cap slowly to release the internal pressure before removing the cap.
- If oil has been added to above the H mark, stop the engine and wait for the hydraulic oil to cool down, then drain the excess oil from drain plug .

1. If the work equipment is not in the condition shown in the diagram on the right, start the engine run the engine at low speed, retract the arm and bucket cylinders, then lower the boom, set the bucket teeth in contact with the ground, and stop the engine.
2. Within 15 seconds after stopping the engine, move each control lever (work equipment and travel) to full stroke in all directions to release the internal pressure.
3. Check sight gauge . The oil level is normal if between the H and L marks.

NOTICE

Do not add oil if the level is above the H line. This will damage the hydraulic equipment and cause the oil to spurt out.

4. If the level is below the L mark, remove the upper cover of the hydraulic tank and add oil through oil filler .

For details of the oil to use, see 20. "USE OF FUEL, COOLANT AND LUBRICANTS ACCORDING TO AMBIENT TEMPERATURE".

REMARK

The oil level will vary depending upon the oil temperature.

Accordingly, use the following as a guide:

- Before operation: around L level
(Oil temperature 10 to 30°C (50 to 86°F))
- Normal operation: around H level
(Oil temperature 50 to 80°C (122 to 176°F))

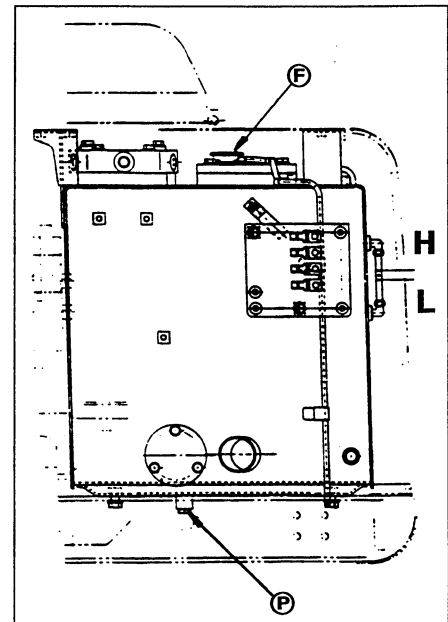
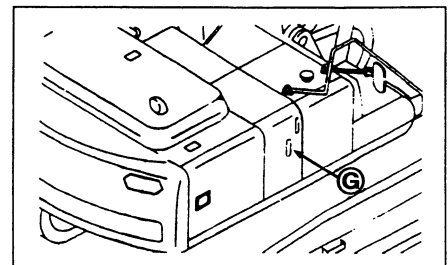
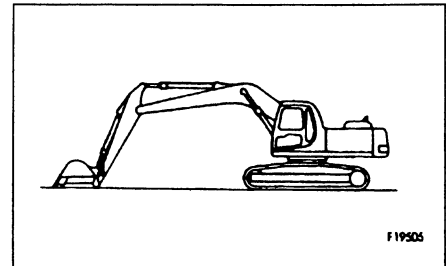

24.2.5 CHECK AIR CLEANER FOR CLOGGING

1. Confirm that the air cleaner clogging monitor does not flash.
2. If it flashes, immediately clean or replace the element.

For details of the method of cleaning the element, see 24.2.1 "CHECK, CLEAN AND REPLACE AIR CLEANER ELEMENT".

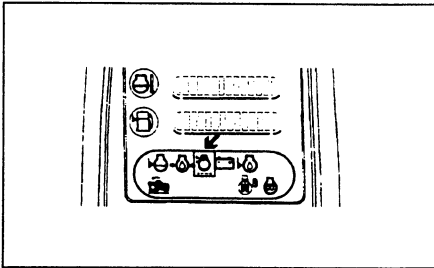

24.2.6 CHECK ELECTRIC WIRING



If the fuse blows frequently, or there are traces of short-circuiting in the electric wiring, always locate and repair the cause.

Check for damage of the fuse and any sign of disconnection or short circuit in the electric wiring. Check also for loose terminals and tighten any loose parts. Check the following points carefully.

- Battery
- Starting motor
- Alternator

Please contact your Komatsu distributor for investigation and correction of the cause.

24.2.7 CHECK FOR WATER AND SEDIMENT IN SEDIMENTOR. DRAIN WATER AND SEDIMENT

A fuel sedimentor is mounted in the pump compartment and is accessed by the door on the right hand side of the machine. Entrapped sediment and water can be seen through the glass bowl.

1. Loosen drain plug ① and drain water and sediment until none is visible in bowl.
 2. Tighten drain plug.
- Ⓐ Fuel
Ⓑ Water/sediment

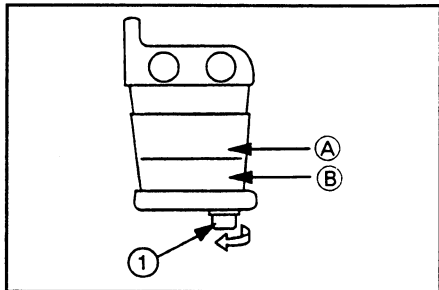

CHECK FOR WATER IN PRIMARY FUEL FILTER, DRAIN WATER

A primary fuel filter is fitted on the engine. Drain the water from the primary fuel filter by turning cap at the bottom of the filter.

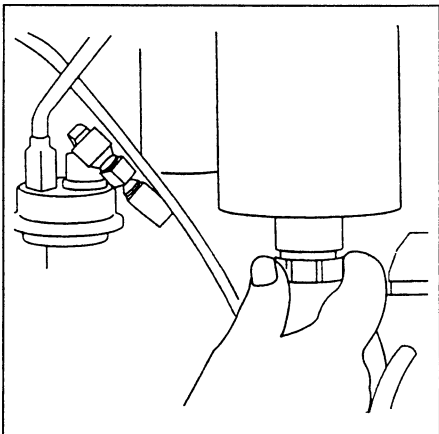

24.3 EVERY 100 HOURS SERVICE

24.3.1 LUBRICATING

1. Set the work equipment in the greasing posture below, then lower the work equipment to the ground and stop the engine.
2. Using a grease pump, pump in grease through the grease fittings shown by arrows.
3. After greasing, wipe off any old grease that was pushed out.

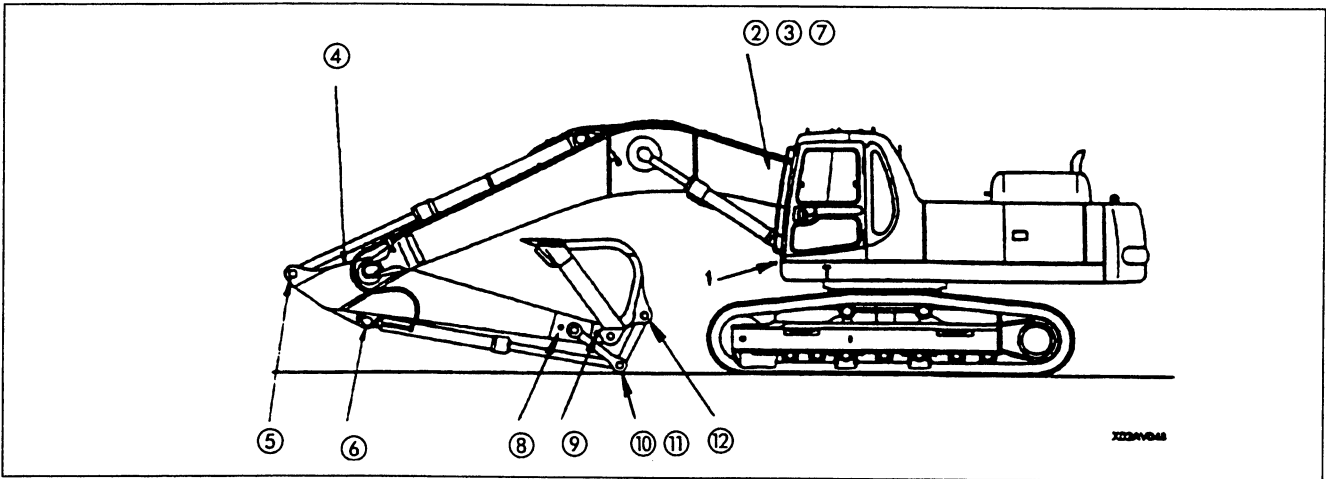

1. Boom cylinder foot pin (2 points)

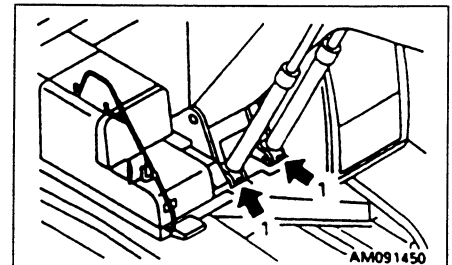

2. Boom cylinder rod pin (2 points)
3. Arm cylinder foot pin (1 point)

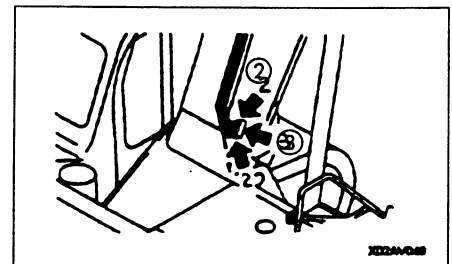

4. Boom-Arm coupling pin (1 point)
5. Arm cylinder rod end (1 point)
6. Bucket cylinder foot pin (1 point)

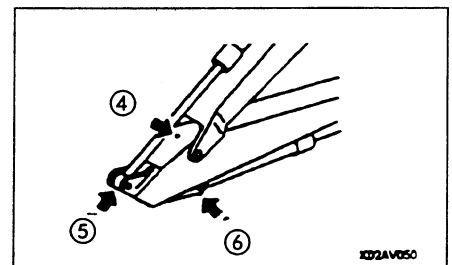

24. SERVICE PROCEDURE

7. Boom foot pin (2 points)

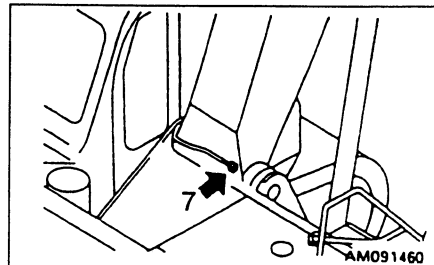

8. Arm-Link coupling pin (1 point)

9. Arm-Bucket coupling pin (1 point)

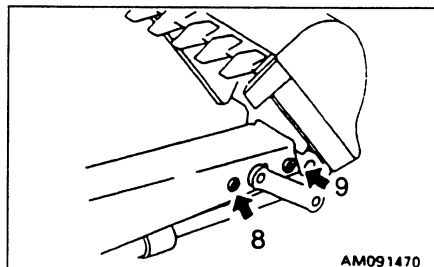

10. Link coupling pin (2 points)

11. Bucket cylinder rod end (1 point)

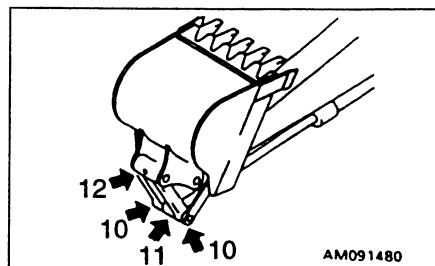

12. Bucket-Link coupling pin (1 points)



24.3.2 CHECK OIL LEVEL IN SWING MACHINERY CASE, ADD OIL

WARNING

The oil is at high temperature immediately after the machine has been operated. Wait for the oil to cool down before carrying out this check.

1. Remove dipstick  and wipe the oil from the dipstick with a cloth.
2. Insert dipstick  fully in the guide.
3. When dipstick  is pulled out, if the oil level is between the H and L marks of the gauge, oil level is correct.

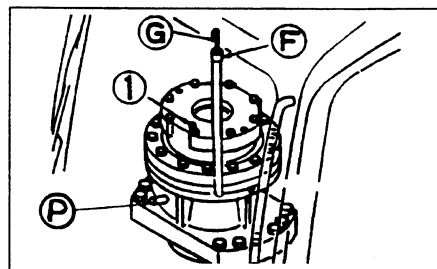

- If the oil does not reach the L mark (F) on dipstick (C), add engine oil through dipstick insertion hole (F).
When refilling, remove bleeding plug (1).

For details of the oil to use, see 20. "USE OF FUEL, COOLANT AND LUBRICANTS ACCORDING TO AMBIENT TEMPERATURE".

- If the oil level exceeds the H mark on the dipstick, loosen drain plug (E) to drain the excess oil.
- After checking oil level or adding oil, insert the dipstick into the hole and install air bleeding plug (1).

24.3.3 DRAIN WATER AND SEDIMENT FROM FUEL TANK

- Carry out this procedure before operating the machine.
- Prepare a container to catch the fuel that is drained.
- Open valve (1) at the bottom of the tank and drain the sediment and water that has accumulated at the bottom together with fuel. When doing this, be careful not to get fuel on yourself.
- When only clean fuel comes out, close drain valve (1).

NOTICE

Never use trichlene for washing the inside of the tank.

24.3.4 CLEAN FRESH AIR INTAKE FILTER

- Remove 4 wing nuts (2) from partition (3) and remove cover (1).
- Access to filter assy (4) is now possible through hole. Remove two wing nuts (6) holding retaining strap (5).
- Grasp filter element (7) centrally and pull out of housing.
- Note that filter element is a sandwich of a fine filter and a coarse filter.
Clean filter by placing element in a mixture of hand hot water and neutral detergent with the coarse filter side downwards. Move element up and down to release dirt.
(A) Coarse (outside)
(B) Fine (inside)

Rinse filter with clean water from the fine filter side.

- Dry filter, compressed air may be used, but apply air from fine filter side.
- Refit filter element ensuring coarse filter side is facing outwards.

Notice.

The normal cleaning interval is 100 hours, however if the machine is used at a dusty site, shorten this interval.

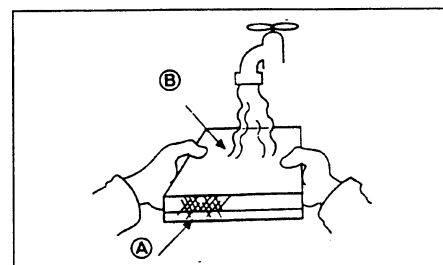
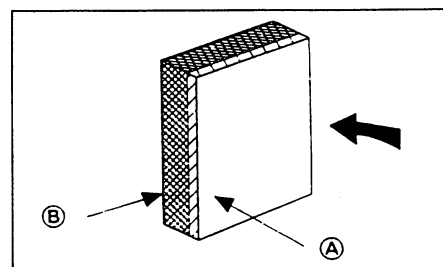
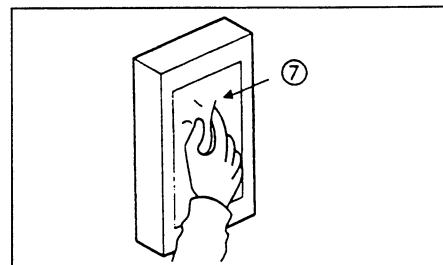
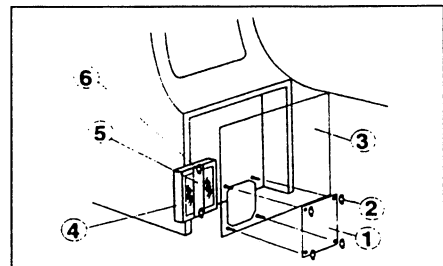
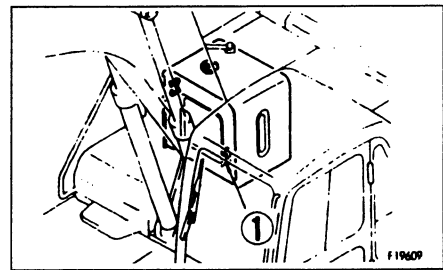

24.4 EVERY 250 HOURS SERVICE

24.4.1 CHECK OIL LEVEL IN FINAL DRIVE CASE, ADD OIL

⚠ WARNING

- The oil is at high temperature immediately after the machine has been operated. Wait for the oil to cool down before starting the operation.
- If there is still pressure remaining inside the case, the oil or plug may fly out; Loosen the plug slowly to release the pressure.

1. Set the TOP mark at the top, with the TOP mark and plug ⑥ perpendicular to the ground surface.
2. Remove plug ⑥. If the oil is level with the bottom of the plug hole, or is no lower than 10 mm below the bottom of the plug hole, then the oil level is correct.
3. If the oil level is too low, install plug ⑥, operate the travel levers, and drive forward or in reverse to rotate the sprocket one turn. Then repeat Step 2 to check again.
4. If the oil is still low, add engine oil through the hole in plug ⑥ until the oil overflows.

For details of the oils to use, see 20. "USE OF FUEL, COOLANT AND LUBRICANTS ACCORDING TO AMBIENT TEMPERATURE."

5. After checking, install plug ⑥.

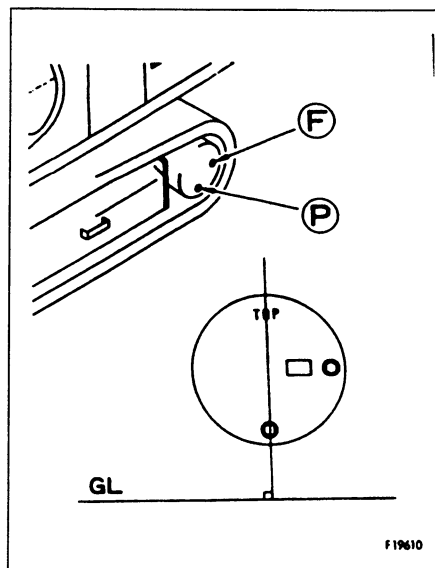

24.4.2 CHECK LEVEL OF BATTERY ELECTROLYTE

WARNING

- To avoid gas explosions, do not bring fire or sparks near the battery.
- Battery electrolyte is dangerous. If it gets in your eyes or on your skin, wash it off with large amounts of water, and consult a doctor.

Carry out this check before operating the machine.

1. Open the battery door on the left side of the machine.
2. Remove cap ①, and check that the electrolyte is at the specified level (10 to 12 mm (0.40 to 0.47 in) above the plate). If the electrolyte level is low, add distilled water to the specified level.

If the battery electrolyte is spilled, have dilute sulphuric acid added.

3. Clean the air hole in the battery cap, then tighten the cap securely.

When adding distilled water in cold weather, add it before starting operations in the morning to prevent the electrolyte from freezing.

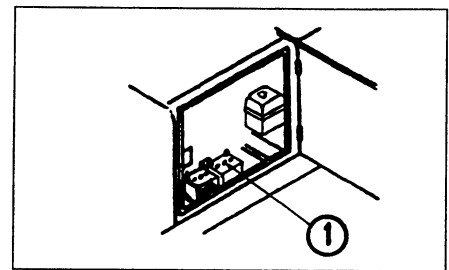

24.4.3 REPLACE HYDRAULIC FILTER ELEMENT

⚠ WARNING

When removing the oil filler cap, turn it slowly to release the internal pressure before removing it.

1. Remove the cover over the hydraulic tank.
2. Remove the cap from oil filler (F), and release the internal pressure.
3. Loosen 4 bolts, then remove cover (1).
When doing this, the cover may fly out under the force of spring (2), so hold the cover down when removing the bolts.
4. After removing spring (2) and valve (3) take out element (4).
5. Clean the removed parts in diesel oil.
6. Install a new element in the place where old element (4) was installed.
7. Set valve (3) and spring (2) on top of the element.
8. Set cover (1) in position, push it down by hand, and install the cover with the mounting bolts.

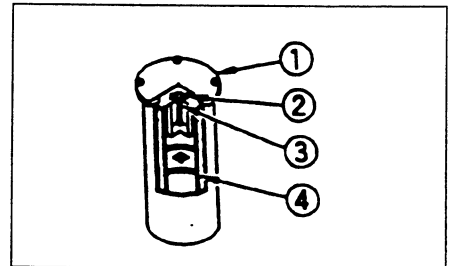
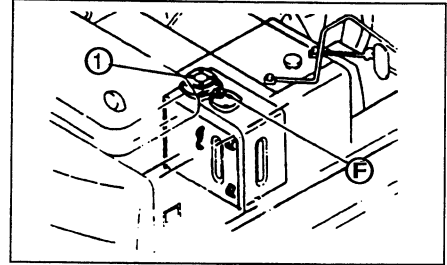

9. Screw in the oil filler cap and install the cover.
10. To bleed the air, start the engine according to 12.2 "STARTING ENGINE" and run the engine at low idling for 10 minutes.
11. Stop the engine.

REMARK

Operate the machine after halting for more than 5 minutes to eliminate bubbles in the oil inside the tank.

12. Check for oil leakage and wipe off any spilled oil.

When the hydraulic breaker is installed, the hydraulic oil deteriorates earlier than in normal bucket digging work.

The first element replacement should be at 100 to 150 hours for new machines. Thereafter, replace the element according to the table on the right. Replace the additional filter element for the breaker every approx 250 hours (when breaker operating ratio is more than 50%) according to the table on the right (see 24.2.15 "Replace Additional breaker Filter Element")

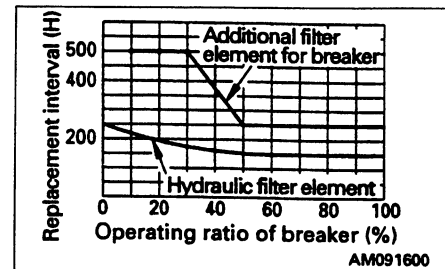

24.4.4 LUBRICATE SWING CIRCLE (2 points)

1. Lower the work equipment to the ground.
2. Using a grease pump, pump in grease through the grease fittings shown by arrows.
3. After greasing, wipe off all the old grease that was pushed out.

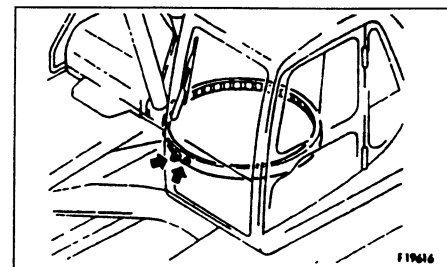

24.4.5 BELTS, GENERAL

WARNING

Before working on the engine or electrical system, disconnect the negative (ground) battery cable. Tag the cable and controls to warn against starting.

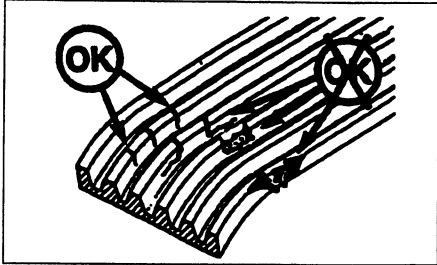

Replace badly worn, greasy or severely cracked belts immediately. These conditions prevent the belt from functioning correctly.

Prior to installing new belts, make sure all pulley grooves are clean and not worn. If a pulley is damaged or if the grooves are worn, it should be replaced.

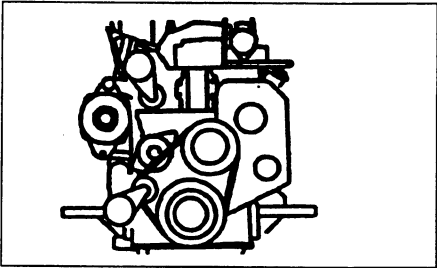

All pulley support bearings, shafts and brackets must be in working order.

When replacing belts and pulleys, pulley alignment must be checked with belts tensioned and brackets securely clamped. A misalignment that can be detected by the naked eye is detrimental to belt performance.

During belt installation, do not force the belts into the pulley grooves by prying with a screwdriver or pry bar. This will damage the belt side cords which will cause the belts to turn and result in complete destruction of the belts in operation.

Belts on new machines and replacement belts lose their tension as they seat into the pulley grooves. Check the tension of new belts at 20 hour intervals until tension is stabilized and thereafter, every 250 hours. If the tension falls below the required minimum, the belt slips, and damages the belts and pulley grooves.

REMARK: When operating in abrasive conditions, check tension every 100 hours.

Visually inspect the belts for intersecting cracks. Transverse (across the belt width) cracks are acceptable. Longitudinal (direction of belt length) cracks that intersect with transverse cracks are not acceptable. Replace the belt if it is frayed or has pieces of material missing.

24.4.6 CHECK FAN BELT TENSION, ADJUST CHECKING TENSION

The engine is equipped with an automatic belt tensioner that maintains correct tension on the drive belt. To check belt tension a Gates type gauge must be used because of the wide drive belt. Proper tension should be 355 to 455 N•m (80 to 110 lbs.) gauge value.

If a Gates type gauge is not available, tension may be checked by belt deflection. Press the belt with your finger at the longest span and measure the deflection. Maximum deflection 9.5 to 12.7 mm (0.37 to 0.50 in).

ADJUSTING

With the automatic belt tensioner, no adjustment is required.

REPLACEMENT

To replace the drive belt, place a 3/8 in. drive ratchet ② in the 3/8 in. square drive hole in the belt tensioner. Push the ratchet "UP" to loosen the tensioner. Remove the old belt ①. Inspect belt tensioner. The tensioner pulley should spin freely with no rough spots detected under hand pressure. Install the new belt.

24.4.7 CHECK ALTERNATOR AND WATER PUMP BELT TENSION, ADJUST CHECKING TENSION

The engine is equipped with an automatic belt tensioner that maintains correct tension on the drive belt. To check belt tension a Gates type gauge must be used because of the wide drive belt. Proper tension should be 355 to 455 N·m (80 to 110 lbs.) gauge value.

If a Gates type gauge is not available, tension may be checked by belt deflection. Press the belt with your finger at the longest span and measure the deflection. Maximum deflection 9.5 to 12.7 mm (0.37 to 0.50 in).

ADJUSTMENT

With the automatic belt tensioner, no adjustment is required.

REPLACEMENT

To replace the drive belt, place a 3/8 in. drive ratchet in the 3/8 in. square drive hole in the belt tensioner. Push the ratchet "UP" to loosen the tensioner. Remove the old belt. Inspect belt tensioner. The tensioner pulley should spin freely with no rough spots detected under hand pressure. Install the new belt.

NOTE: The belt tensioner is spring loaded and must be pivoted away from the belt. Pivoting in the wrong direction can result in damage to the belt tensioner.

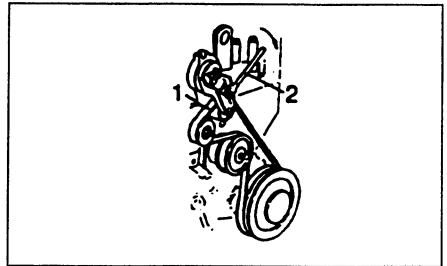
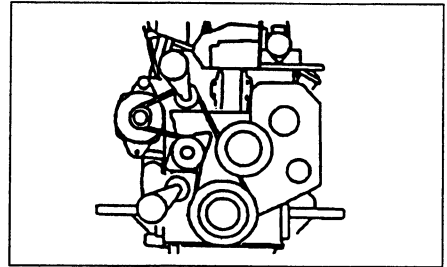
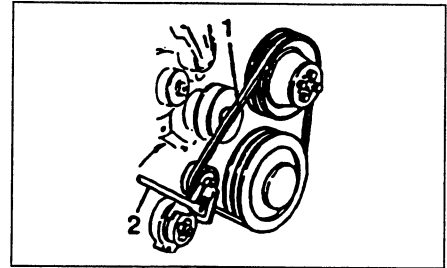

24.4.8 CHECK AND ADJUST TENSION OF AIR CONDITIONER COMPRESSOR BELT

Testing

The belt should deflect 14-16 mm (0.55-0.63in) when pressed with a finger force of approx. 6 kg (13 lb) at a point midway between the crankshaft pulley and the compressor pulley.

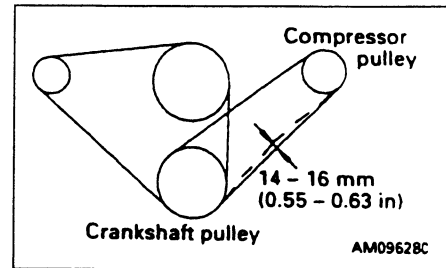
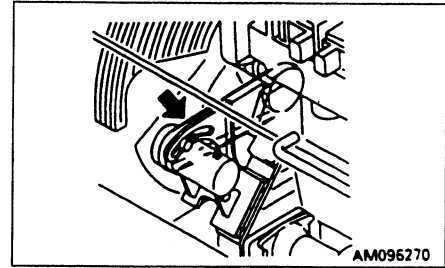

Adjusting

1. Loosen 2 bolts ① and 2 bolts ②, and move compressor ③ to adjust.
2. When the deflection is correct, tighten bolts ① and ② to hold the compressor in position.
3. Check each pulley for damage, and check the V-groove and V-belt for wear. In particular, check that the V-belt is not contacting the bottom of the V-groove.
4. If the V-belt is stretched and cannot be adjusted any further, or if there are any cuts or cracks, replace the V-belt.
5. After replacing the V-belt, adjust again after one hour of operation.

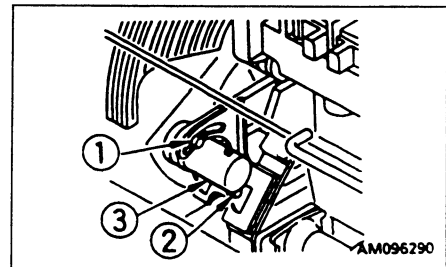

24.5 EVERY 500 HOURS SERVICE

Maintenance for every 50, 100 and 250 hours should be carried out at the same time.

24.5.1 REPLACE FUEL FILTER CARTRIDGES

⚠ WARNING

- Engine is at high temperature immediately after the machine has been operated. Wait for engine to cool down before replacing the filter.
- Keep naked flames - sparks away from fuel.
- When cranking the engine, ensure all safety procedures have been followed, as the engine may start.

Get a filter wrench and a container to catch the fuel.

1. Set the container to catch the fuel under the filter cartridges.
2. Using a filter wrench, turn filter cartridges ① and ② counterclockwise to remove them.
3. Clean the filter holders, fill new filter cartridges with clean fuel, coat the packing surface with engine oil, then install them to the filter holders.
4. When installing, tighten until the packing surface contacts the seal surface of the filter holder, then tighten it up 1/2 to 3/4 of a turn.

If the filter cartridge is tightened too far, the packing will be damaged and this will lead to leakage of fuel. If the filter cartridge is too loose, fuel will also leak from the packing, so always tighten to the correct amount.

5. After replacing the fuel filter cartridges, bleed the air from the system.
Bleed the air as follows.
6. Fill the tank with fuel (to the position where the fuel gauge shows FULL).
7. After replacing filter cartridges ①, loosen air bleed plugs .
8. Operate the lift pump plunger up and down, and continue until no more bubbles come out with the fuel from air bleed plugs .
9. Tighten air bleed plugs. Use genuine Komatsu filter cartridges. After replacing the filter cartridges, start the engine and check that there is no leakage of fuel from the filter seal surface.

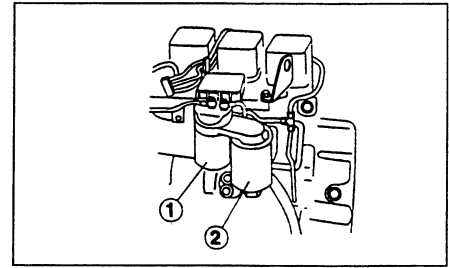

Fuel System

Bleeding

Controlled venting is provided at the injection pump through the fuel drain manifold. Small amounts of air introduced by changing the fuel filters or fuel injection pump supply line will be vented automatically, if the fuel filter is changed in accordance with the instructions. No manual bleeding of fuel lines is required.

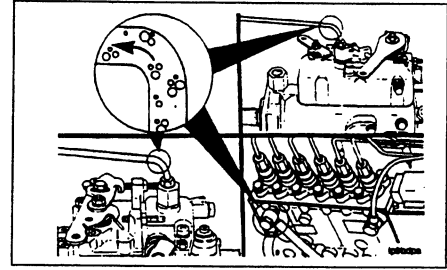

NOTE: Manual bleeding is required if:

- The fuel filter is not filled prior to installation.
- Fuel injection pump is replaced.
- High pressure fuel line connections are loosened or fuel lines replaced.
- Initial engine start up or start up after an extended period of no engine operation.
- Vehicle fuel tank has been run until empty.

Low Pressure Lines and Fuel Filter(s)

Venting

1. Open the bleed screw
2. Operate the plunger on the lift pump until the fuel flowing from the fitting is free of air.

Tighten the bleed screw.

Torque Value: 9 N•m [80 in-lb]

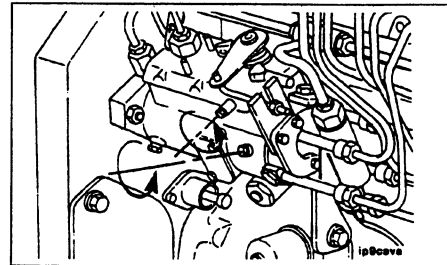
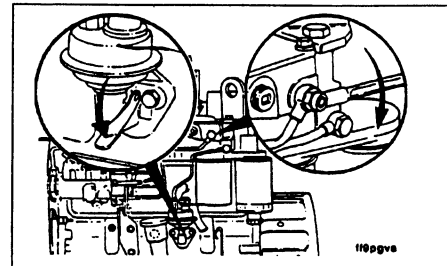
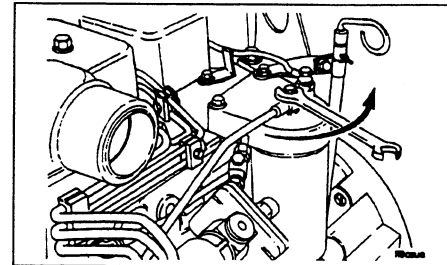

Caution: When using the starting motor to vent the system, do not engage it for more than 30 seconds at a time:
 Wait two (2) minutes between engagements.

Warning: It is necessary to put the engine in the "Run" position. Because the engine may start, be sure to follow all the safety precautions. Use the normal engine starting procedure.

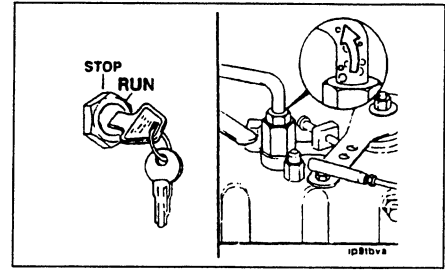

High pressure Lines

Venting

Warning: The pressure of the fuel in the line is sufficient to penetrate the skin and cause serious bodily harm.

1. Loosen the fittings at het injectors, and crank the engine to allow entrapped air to bleed from the lines. Tighten the fittings.

Re- Tighten Line Fittings

Torque Value: 30 N•m [22 ft-lb]

Warning: Do not bleed a hot engine as this could cause fuel to spill onto a hot exhaust manifold creating a danger of fire.

2. Start the engine and vent one line at a time until the engine runs smoothly.

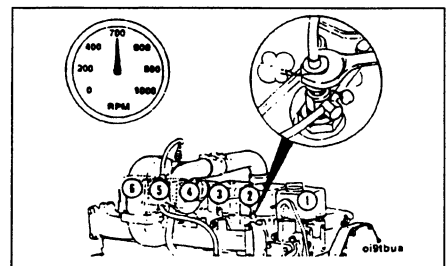
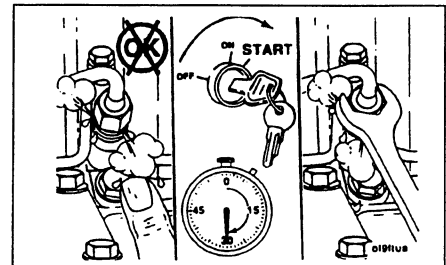

24.5.2 CHECK SWING PINION GREASE LEVEL, ADD GREASE

Prepare a scale.

1. Remove bolts ① (2 bolts) on the top of the revolving frame and remove cover ④.
2. Check the colour of the grease. If it is milky white, it is necessary to change the grease. Please contact your Komatsu distributor.

The total amount of grease is 33 ℓ (29.7 kg) (8.7 US gal, 7.3 UK gal [65.5 lb]).

3. Insert a rule into the grease and check that the depth of the grease is at least 25 mm (1.0 in). Add more grease if necessary.
4. To add more grease replace cover ④ and bolts ① (2 bolts), remove bolts ② (2 bolts) on the top of the revolving frame and remove cover ③. Add more grease.
5. Replace cover ③ with bolts ②.

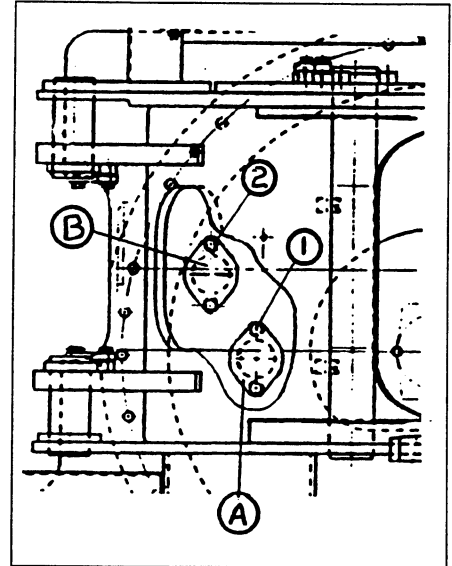
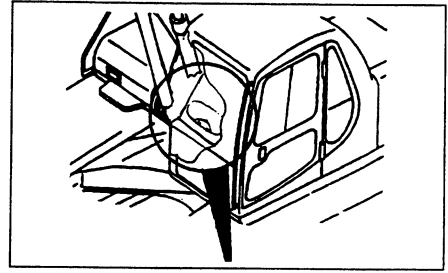

24.5.3 CHANGE OIL IN ENGINE OIL PAN, REPLACE ENGINE OIL FILTER CARTRIDGE





Perform this maintenance every 500 hours on machines equipped with bypass filter.

WARNING

The oil is at high temperature after the engine has been operated, so never change the oil immediately after finishing operations. Wait for the oil to cool down before changing it.

Prepare the following

- Container to catch drained oil: Min 26.0 ℓ capacity (PC200)/ 17.0 ℓ (PC160, PC180)
- Refill capacity: 25.0 ℓ (PC200)/16.0 ℓ (PC 160/PC180)
- Filter wrench

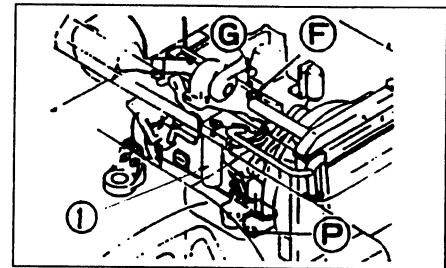

1. Remove the inspection cover of the undercover directly under drain plug  under the machine, then place a container to catch the oil.
2. Lower the lever of drain valve  slowly to prevent getting oil on yourself, and drain the oil. After draining the oil, raise the lever to close the valve.
3. Check the drained oil, and if there are excessive metal particles or foreign material, please contact your distributor.
4. Tighten drain valve .
5. Using the filter wrench from the lower side of the engine, turn filter cartridge  counterclockwise to remove it.
In particular, if this operation is carried out immediately after stopping the engine, a large amount of oil will come out, so wait for 10 minutes before starting the operation.
6. Clean the filter holder.



REMARK

Confirm that no remnants of old packing still adhere to the filter holder as this may result in oil leakage.

NOTICE: Do not tighten filter or use any tools for installation because this can damage the gasket and filter.

7. Fill the new filter with clean oil.
8. Install the new filter by applying a little engine oil to the seal and thread the filter on by hand by turning it clockwise until hand tight.
9. After replacing the filter cartridge, add engine oil through oil filler  until the oil level is between the H and L marks on dipstick .

For details of the oil to use, see 20 "USE OF FUEL, COOLANT AND LUBRICANTS ACCORDING TO AMBIENT TEMPERATURE" on page 3-12.

NOTICE

Even if the machine has not been operated for 500 hours, the oil and filter cartridge must be replaced when the machine has been operated for 6 months.

In the same way, even if the machine has not been operated for 6 months, the oil and filter cartridge must be replaced when the machine has been operated for 500 hours.

24.5.4 CLEAN AND INSPECT RADIATOR FINS, OIL COOLER FINS AND CONDENSER FINS (ONLY FOR MACHINES EQUIPPED WITH AIR-CONDITIONER)

⚠ WARNING

If compressed air, steam, or water hit your body directly, there is danger of injury. Always wear protective glasses, mask, and safety shoes.

1. Open the engine hood and rear door on the left side of the machine. Loosen bolts ① and remove the radiator front cover.
2. Blow off mud, dust or leaves clogging the radiator fins and oil cooler fins using compressed air. At the same time, clean the net in front of the oil cooler. Clean the condenser fins on machines equipped with the air conditioner. The condenser is located on the front of the radiator. Steam or water may be used instead of compressed air.
3. Check the rubber hose. Replace with a new one if the hose is found to have cracks or to be hardened by ageing. Further, check hose clamps for looseness.

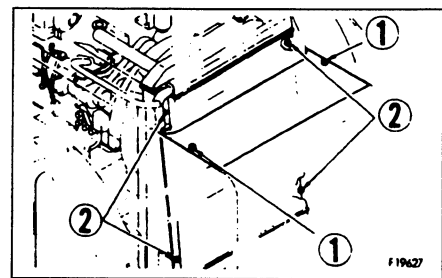

NOTICE

To prevent damage to the fins, apply compressed air from an appropriate distance. Damaged fins may cause water leakage or overheating. In a dusty site, check the fins daily, irrespective of the maintenance interval.

24.5.5 REPLACE HYDRAULIC TANK BREATHER ELEMENT

⚠ WARNING

Wait for the oil to cool down before replacing the breather element. When removing the oil filler cap, turn it slowly to release the internal pressure, then remove it carefully.

1. Remove the cover over the hydraulic tank and remove the cap of oil filter ⑥.
2. Replace element ① inside the cap with a new one.

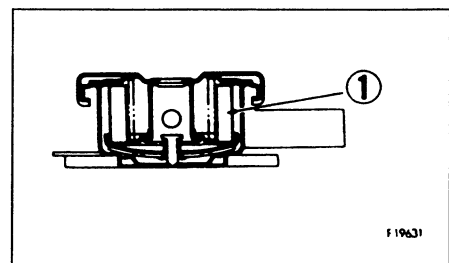
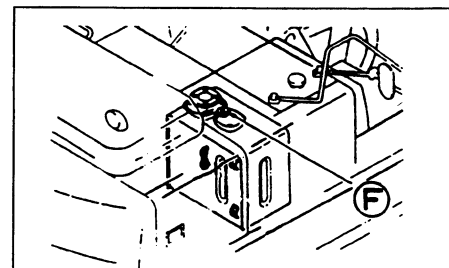

24.6 EVERY 1000 HOURS SERVICE

Maintenance for every 50, 100, 250 and 500 hours should be carried out at the same time.

24.6.1 CHANGE OIL IN SWING MACHINERY CASE

⚠ WARNING

The oil is at high temperature immediately after the machine has been operated. Wait for the oil to cool down before carrying out maintenance.

- Container to catch drained oil: Min. 4 ℓ capacity.
 - Refill capacity: 4 ℓ (1.05 US gal, 0.9 UK gal).
1. Set an oil container under drain plug **P** under the machine body.
 2. Loosen drain valve **P** under the body, drain the oil, then tighten the drain valve again.
 3. Remove dipstick **G** and bleeding plug **I**.
Add the specified amount of engine oil through gauge hole **F**.

For details of the oil to use, see 20. "USE OF FUEL, COOLANT AND LUBRICANTS ACCORDING TO AMBIENT TEMPERATURE", page 3-12.

4. After refilling, install bleeding plug **I**.
5. Wipe off oil on the dipstick with a cloth.
6. Insert dipstick **G** into the gauge pipe thoroughly and then pull out it again.
7. When the oil level is between the H and L marks, on dipstick **G**, it is normal. If the oil does not reach the L mark, add more oil through oil filler **F**.
8. If the oil level exceeds the H mark, drain the excess engine oil from drain plug **P**, and check the oil level again.

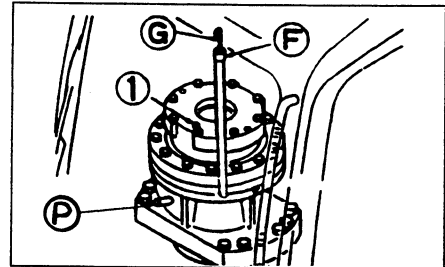

**24.6.2 CHECK ALL TIGHTENING PARTS OF
TURBOCHARGER**

Contact your Komatsu distributor to have the tightening portions checked.

24.6.3 CHECK PLAY OF TURBOCHARGER ROTOR.

Ask Komatsu distributor to check the play of the turbocharger rotor.

24.6.4 CHECK & ADJUST VALVE CLEARANCE

1. Adjusting the valves

Remove the valve covers.

2. Locate Top Dead Center (TDC) for Cylinder Number 1 by rotating the crankshaft slowly while pressing on the engine timing pin Ⓐ

3. When the pin engages the hole in the camshaft gear, Cylinder Number 1 is at TDC on the compression stroke.

CAUTION: Be sure to disengage the pin after locating TDC.

Valve clearance intake: 0-254 mm (0-10 inch)
 exhaust: 0-508 mm (0-020 inch)

Check/set valves with engine cold - below 60°C (140°F)

NOTE:

The clearance is correct when some resistance is 'felt' when the feeler gauge is slipped between the valve stem and the rocker lever.

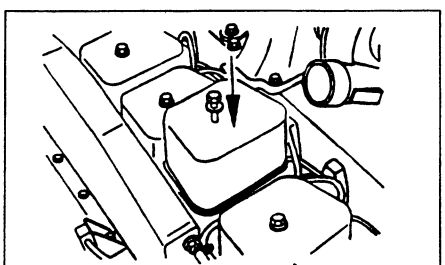
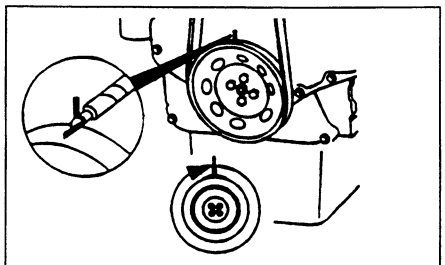
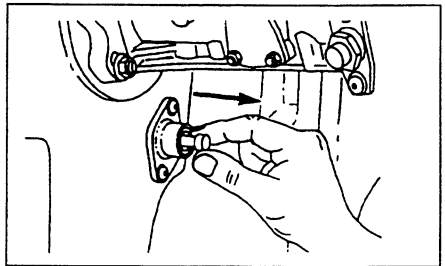
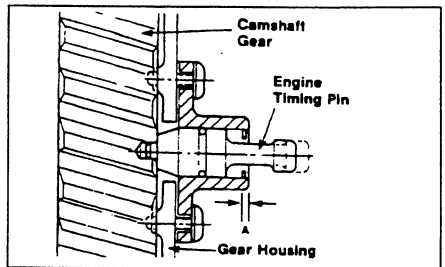
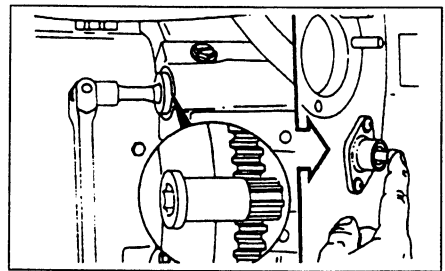
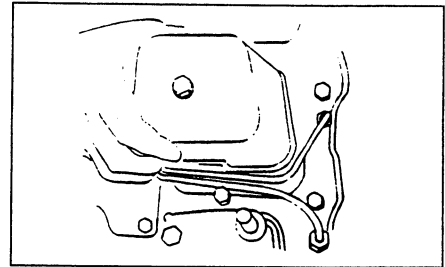

FOUR CYLINDER ENGINE (PC160, PC180)

With the engine in TDC position, check and adjust the following valve clearances.

Intake (I) cylinders: 1,2

Exhaust (E) cylinders: 1,3

Tighten the lock nut to 24 N.m (18 ft-lbs) and re-check the valve lash

Mark the pulley and rotate the crankshaft 360° degrees.

Be sure timing pin is disengaged, before rotating.

The timing pin will not engage in this position. With the engine in this position, check and adjust the following valve clearances.

Intake (I) cylinders: 3,4

Exhaust (E) cylinders: 2,4

Tighten the lock nut to 24 N.m (18 ft-lbs) and re-check the valve lash.

Install the valve covers and tighten capscrews to 24 N.m (18 ft-lbs)

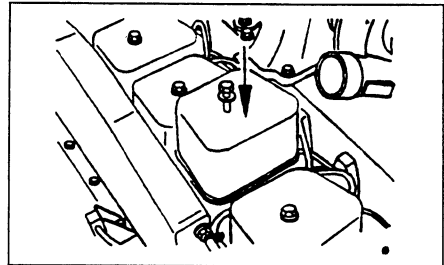
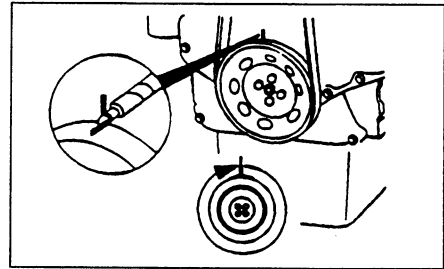
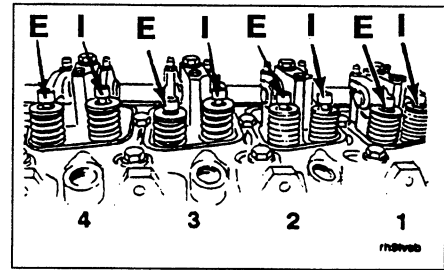

SIX CYLINDER ENGINE (PC200)

With the engine in TDC position, check and adjust the following valve clearances.

Intake (I) cylinders: 1,2,4.

Exhaust (E) cylinders: 1,3,5.

Tighten the lock nut to 24 N.m (18 ft-lbs) and re-check the valve lash.

Mark the pulley and rotate the crankshaft 360° degrees.

Be sure timing pin is disengaged, before rotating.

The timing pin will not engage in this position. With the engine in this position, check and adjust the following valve clearances.

Intake (I) cylinders: 3,5,6.

Exhaust (E) cylinders 2,4,6

Tighten the lock to 24 N.m (18 ft-lbs) and re-check the valve lash.

Install the valve covers and tighten capscrews to 24 N.m (18 ft-lbs).

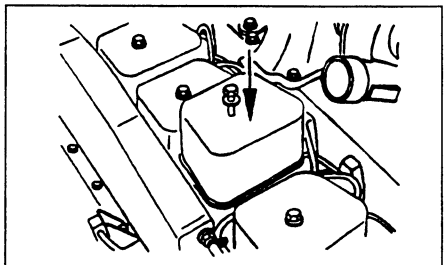
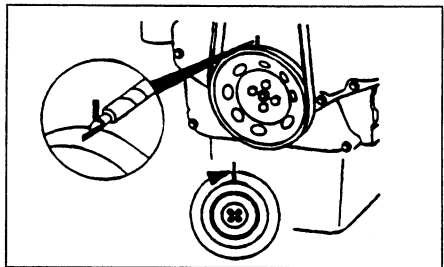
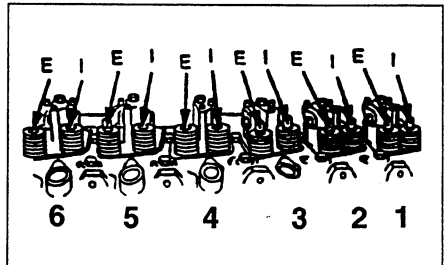

24.6.5 CHECK FAN BELT TENSIONER BEARING BELT AND FAN HUB

- **Check fan belt**

Remove the drive belt by lifting tensioner using a 3/8 inch square drive wrench to release the tension.

Inspect the belt for damage.

Replace belt if any damage is found.

- **Check the tensioner bearing**
With the fan belt removed rotate fan hub.
The tensioner pulley should spin freely with no rough spots detected under hand pressure.

- Check the tensioner bearing.
- Replace bearing if damaged.
- Check fan hub. With the drive belt removed, rotate fan hub.

The fan hub should spin freely without excessive end play.

- Check the fan hub bearing.
- Replace bearing if damaged.

24.6.6 CHECK FAN BELT TENSION

- Measure the belt deflection at the longest span of the belt.
- Maximum deflection: 9.5-12,7 mm (3/8-1/2 inch)
 If tension is low (deflection is outside range):
 (see 24.6.5. "Check fan belt tensioner bearing, belt and fan hub.")
- Check belt & replace if damaged.
- Check tensioner & replace if damaged.

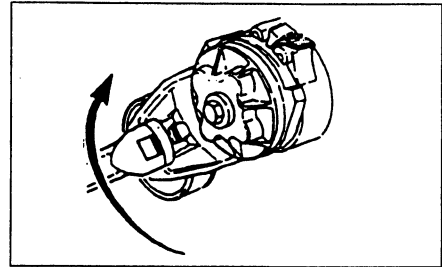

24.7 EVERY 2000 HOURS SERVICE

Maintenance for every 50, 100, 250, 500 and 1000 hours should be carried out at the same time.

24.7.1 CHANGE OIL IN FINAL DRIVE CASE

⚠ WARNING

- The oil is at high temperature immediately after the machine has been operated. Wait for the oil to cool down before carrying out maintenance.
- If there is still pressure remaining inside the case, the oil or plug may fly out. Loosen the plug slowly to release the pressure.

Prepare the following.

- Container to catch drained oil: Min. 4 ℓ capacity
- Refill capacity: 4 ℓ (1.05 US gal, 0.9 UK gal)
- Handle

1. Set the TOP mark at the top, with the TOP mark and plug ⑥ perpendicular to the ground surface.
2. Set a container under plug ⑥ to catch the oil.
3. Remove plug ⑥ and ⑦ with the handle and drain the oil.

REMARK

Check the O-rings in the plugs for damage. If necessary, replace with new ones.

4. Screw in plug ⑥.
5. Add engine oil through the hole of plug ⑦.

For details of the oil to use, see 20. "USE OF FUEL, COOLANT AND LUBRICANTS ACCORDING TO AMBIENT TEMPERATURE".

6. When the oil overflows from the hole of plug ⑦, install plug ⑦. Tightening torque of plugs ⑥ and ⑦: $70 \pm 10\text{Nm}$ ($7 \pm 1\text{ kgm}$, $50 \pm 7\text{ lbft}$).

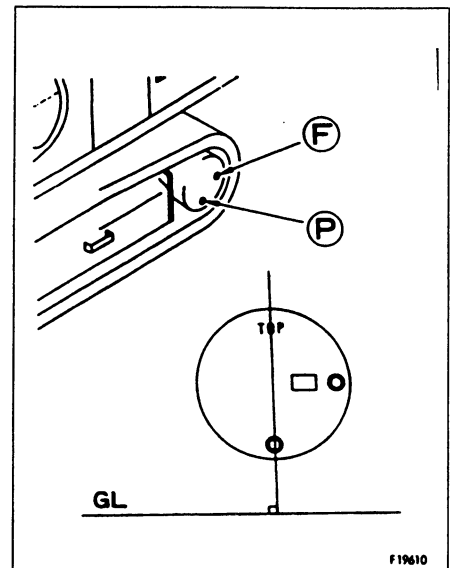

24.7.2 CHANGE OIL IN HYDRAULIC TANK, CLEAN STRAINER

WARNING

The oil is at high temperature immediately after the machine has been operated. Wait for the oil to cool down before changing the oil. When removing the oil filler cap, turn it slowly to release the internal pressure, then remove it carefully.

Prepare the following

- Container to catch drained oil: min. 160 capacity
- Refill, capacity: 160 ℓ (42.2 US gal, 35.2 UK gal)
- Prepare a handle for the socket wrench set.

1. Swing the upper structure so that the drain plug under the hydraulic tank comes at the middle of the left or right track.
2. Retract the arm and bucket cylinders to the stroke end, then lower the boom and put the bucket teeth in contact with the ground.
3. Lock the safety lock lever and stop the engine.
4. Remove the cover over the hydraulic tank and remove the cap of oil filler Ⓢ .
5. Set the oil container under the drain plug under the machine. Using the handle, remove drain plug Ⓟ and drain the oil. Check the O-ring installed to plug Ⓟ , and if it is damaged, replace the O-ring. After draining the oil, tighten drain plug Ⓟ .
Tightening torque: $70 \pm 10 \text{ Nm}$ ($7 \pm 1 \text{ kgm}$, $50 \pm 7 \text{ lbft}$).

When removing drain plug Ⓟ , be careful not to get oil on yourself.

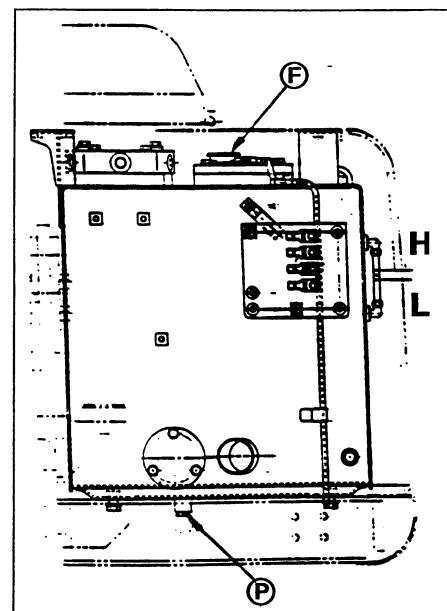
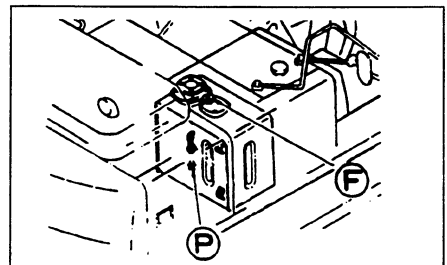
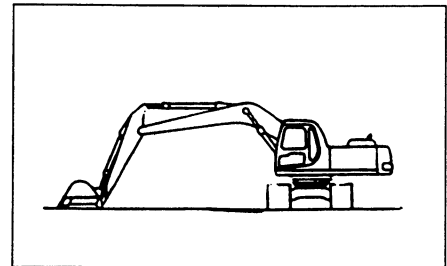

24. SERVICE PROCEDURE

6. Loosen 4 bolts, then remove cover ①.
When doing this, the cover may fly out under the force of spring ②, so push the cover down when removing the bolts.
7. Pull up the top of rod ③, and remove spring ② and strainer ④.
8. Remove the dirt stuck to strainer ④, then wash it in clean diesel oil or flushing oil.
If strainer ④ is damaged, replace it with a new one.
9. Refit strainer ④ by inserting it into tank projecting part ⑤.
10. Install cover ① with bolts.
11. Add the specified amount of engine oil through oil filler port ⑥. Check that the oil level is between H and L on the sight gauge.

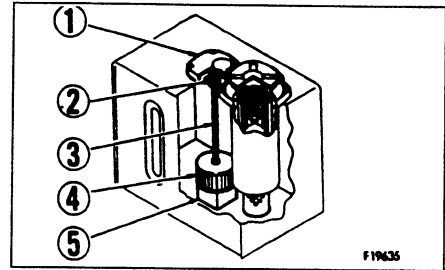

For type of oil to be used, see 20. "USE OF FUEL AND LUBRICANTS ACCORDING TO AMBIENT TEMPERATURE".

NOTICE

When the hydraulic breaker is installed, the hydraulic oil deteriorates earlier than in normal bucket digging work. Therefore replace the hydraulic oil according to the table at the right.

12. After replacing hydraulic oil and cleaning or replacing filter element and strainer, bleed air from the circuit according to the following procedure.

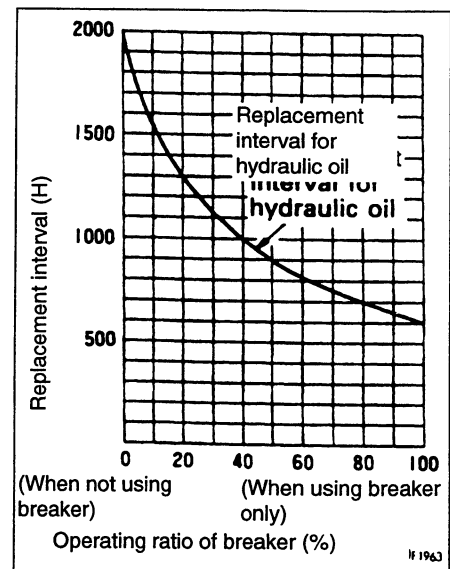

Air bleeding procedure

Follow steps 1 to 7 to bleed the air.

1. Bleeding air from pump

1. Loosen air bleeder plug ① (Port T2) (Underside of pump), and check that oil oozes out from the air bleed plug.
2. If oil does not ooze out from the plug, remove the drain hose from the pump case, and add oil through drain port ② (Port T1, Top of pump) to fill the pump case with hydraulic oil.

Oil will come out from the drain hose when it is removed, so secure the mouth of the hose at a place higher than the oil level inside the hydraulic tank.

3. After completion of the air bleed operation, tighten the air bleeding plug ①, then install the drain hose.

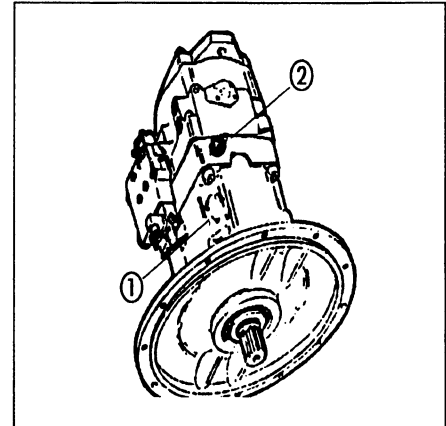
**NOTICE**

If the drain hose is installed first, oil will spurt out from the hole of plug ①.

If the pump is operated without filling the pump case with hydraulic oil, abnormal heat will be generated and this may lead to premature damage of the pump.

2. Starting engine

Start the engine according to 13.2 "STARTING ENGINE" keep running the engine at low idling for 10 minutes, and carry out the following procedure.

3. Bleeding air from cylinders

1. Run the engine at low idling, and extend and retract each cylinder 4 - 5 times without operating it to the end of its stroke. (Stop approx. 100 mm (4 in) before the end of the stroke)
2. Next, operate each cylinder to the end of its stroke 3 - 4 times.
3. After this, operate each cylinder 4 - 5 times to the end of its stroke to completely bleed the air.

NOTICE

If, at first, the engine is run at high speed or the cylinder is operated to the end of its stroke, the air inside the cylinder may cause damage to the piston packing or other parts.

4. Bleeding air from swing motor

1. Run the engine at low idling, loosen air bleeding plug ①, and check that oil oozes out from air bleeding plug ①.

NOTICE

When doing this, do not operate the swing.

2. If oil does not ooze out, stop the engine, remove air bleeding plug ①, fill the motor case with hydraulic oil.
3. After completion of the air bleed operation, tighten air bleeding plug ①.
4. Run the engine at low idling, and swing 2 or more times slowly and uniformly to the left and right.

NOTICE

If the air is not bled from the swing motor, the bearings of the motor may be damaged.

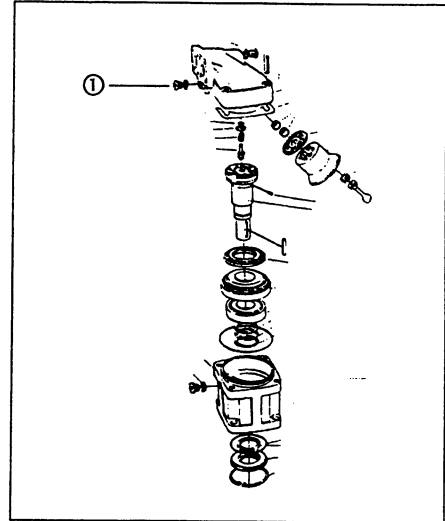

5. Bleeding air from travel motor.

(only after draining oil from travel motor case)

1. Run the engine at low idling, loosen drain line hose connection ① (top of monitor), and if oil flows out, tighten the air bleed plug.
2. Keep the engine running at low idling, and swing the work equipment 90° to bring it to the side of the track.
3. Jack up the machine until the track is raised slightly from the ground. Rotate the track under no load for 2 minutes. Repeat this procedure on both the left and right sides, and rotate the track equally both forward and in reverse.

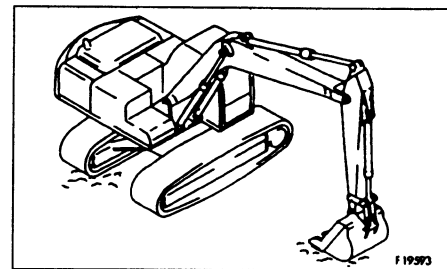
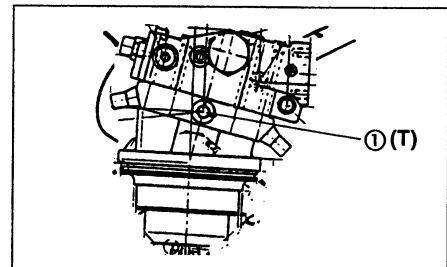

6. Bleeding air from attachment (if installed).

For machines equipped with attachments such as the breaker, actuate the attachment pedal about 10 times to bleed the air completely from the attachment circuit while running the engine at low idling.

NOTE

If the attachment bleeding procedure is specified by the manufacturer, bleed the attachment according to such procedure.

7. Operation

1. After completion of bleeding the air, stop the engine, and wait for at least 5 minutes before starting operations. In this way, the air bubbles are removed from the oil inside the hydraulic tank.
2. Check for any leakage of oil, and wipe off any oil that has been spilled.

24.7.3 CLEAN, CHECK TURBOCHARGER

Contact your Komatsu distributor for cleaning or inspection.

24.7.4 CHECK ALTERNATOR, STARTING MOTOR

The brush may be worn, or the bearing may have run out of grease, so contact your Komatsu distributor for inspection or repair. If the engine is started frequently, carry out inspection every 1000 hours.

24.7.5 CHECK VIBRATION DAMPER

Check that there are no cracks or peeling in the outside surface of the rubber.

If any cracks or peeling are found, contact your Komatsu distributor to have the parts replaced.

24.7.6 CHANGE ANTIFREEZE

Follow the procedure of 24.2.2 "CLEAN INSIDE OF COOLING SYSTEM" for draining and refilling the cooling system.

24.8 EVERY 4000 HOURS SERVICE

Maintenance for every 50, 100, 250, 500, 1000 and 2000 hours should be carried out at the same time.

24.8.1 CHECK WATER PUMP

Check that there is oil leakage, water leakage, or clogging of the drain hole. If any abnormality is found, contact your Komatsu distributor for disassembly and repair or replacement.

SPECIFICATIONS

25. SPECIFICATIONS

25.1 MACHINE SPECIFICATIONS

PC160-6K, PC180LC-6k, PC180NLC-6k
PC200EL-6K, PC200EN-6K

		PC160-6	PC160LC-6	PC180NLC-6	PC200EN-6	PC200EL-6
WEIGHT		(Europe)	(USA)	(Europe)		
• Operating weight		16300	17410	17900	19000	19300
PERFORMANCE						
• Bucket capacity		0.27 ~1.14 m³/0.4 ~ 1.19 m³				
• With of opening	(STD)	900 mm (39.4)				
	(With Side Cutter)	1000 mm				
• Travel speed	- Low speed	2.7			2.3	
	- Middel speed	4.0			3.9	
	- High speed	5.5			5.0	
• Sping speed		12 RPM				
TRACK SHOE						
• Triple Grouser Shoe	(STD)	500	600		500	600
ENGINE						
• Model		SA4D102E			S6D102	
• Flywheel Horsepower		78 KW (106 Ps) 2100 RPM			99 KW (135 Ps) 2200 rpm	
• Starting motor		24V/4.5KW			24V/5.5KW	
• Alternator		24V/55A				
• Battery		12V 95Ah x 2 Pieces				

25. SPECIFICATIONS

PC180LC-6

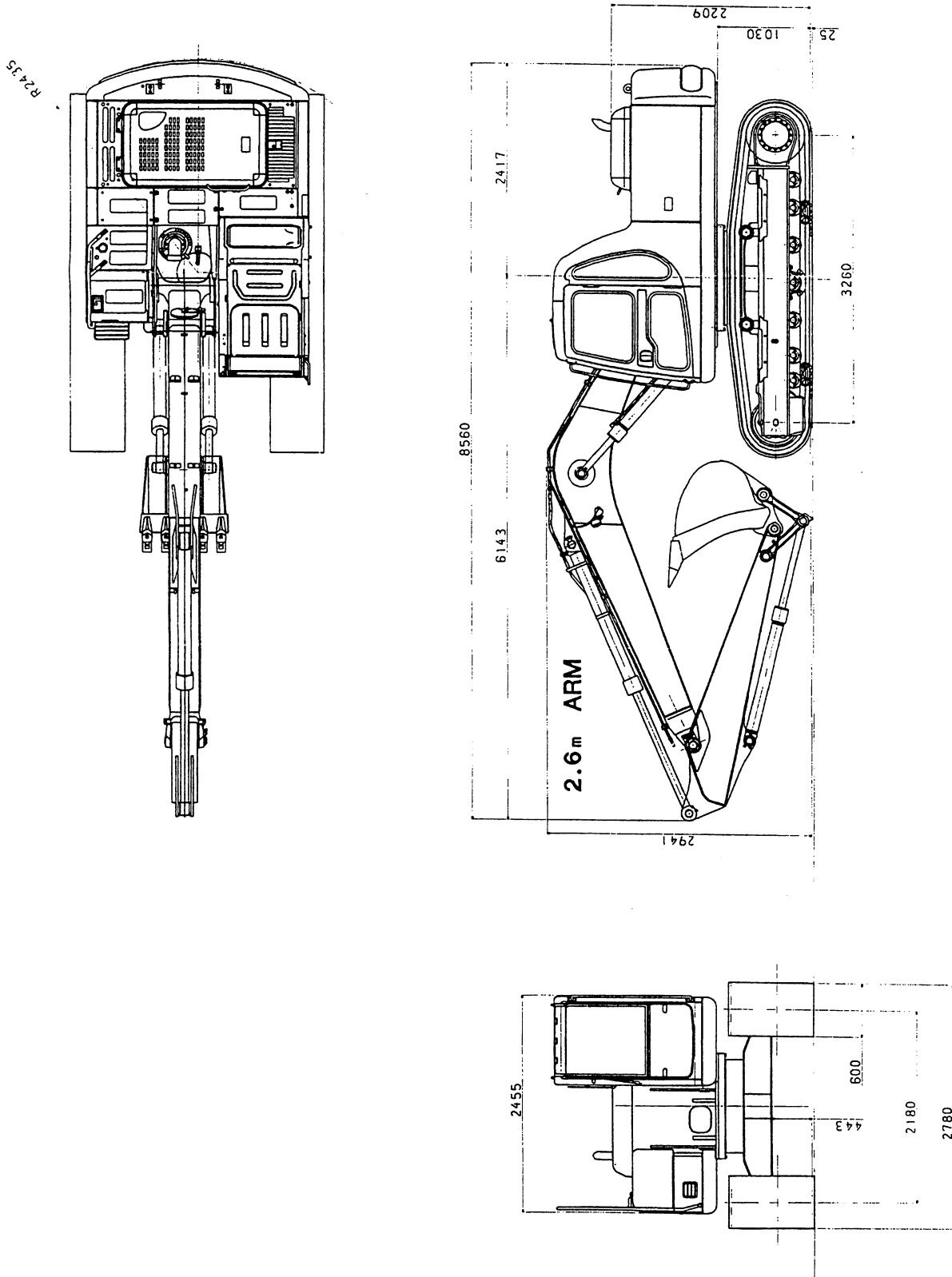

PC160-6k

		1.85m ARM	2.25m ARM	2.62m ARM	2.9m ARM
A	Max. digging height	8735 mm	8800 mm	8865 mm	9015 mm
B	Max. dumping height	6090 mm	6190 mm	6280 mm	6430 mm
C	Max. digging depth	5240 mm	5645 mm	6000 mm	6290 mm
D	Max. digging depth of cal for 8' level	4990 mm	5415 mm	5780 mm	6090 mm
E	Max. digging reach	8355 mm	8675 mm	8960 mm	9230 mm
F	Max. digging reach at ground	8190 mm	8515 mm	8805 mm	9080 mm
G	Min swing radius	3360 mm	3060 mm	3000 mm	3010 mm
H	Work equipment height at min swing radius	7170 mm	7100 mm	7080 mm	7100 mm

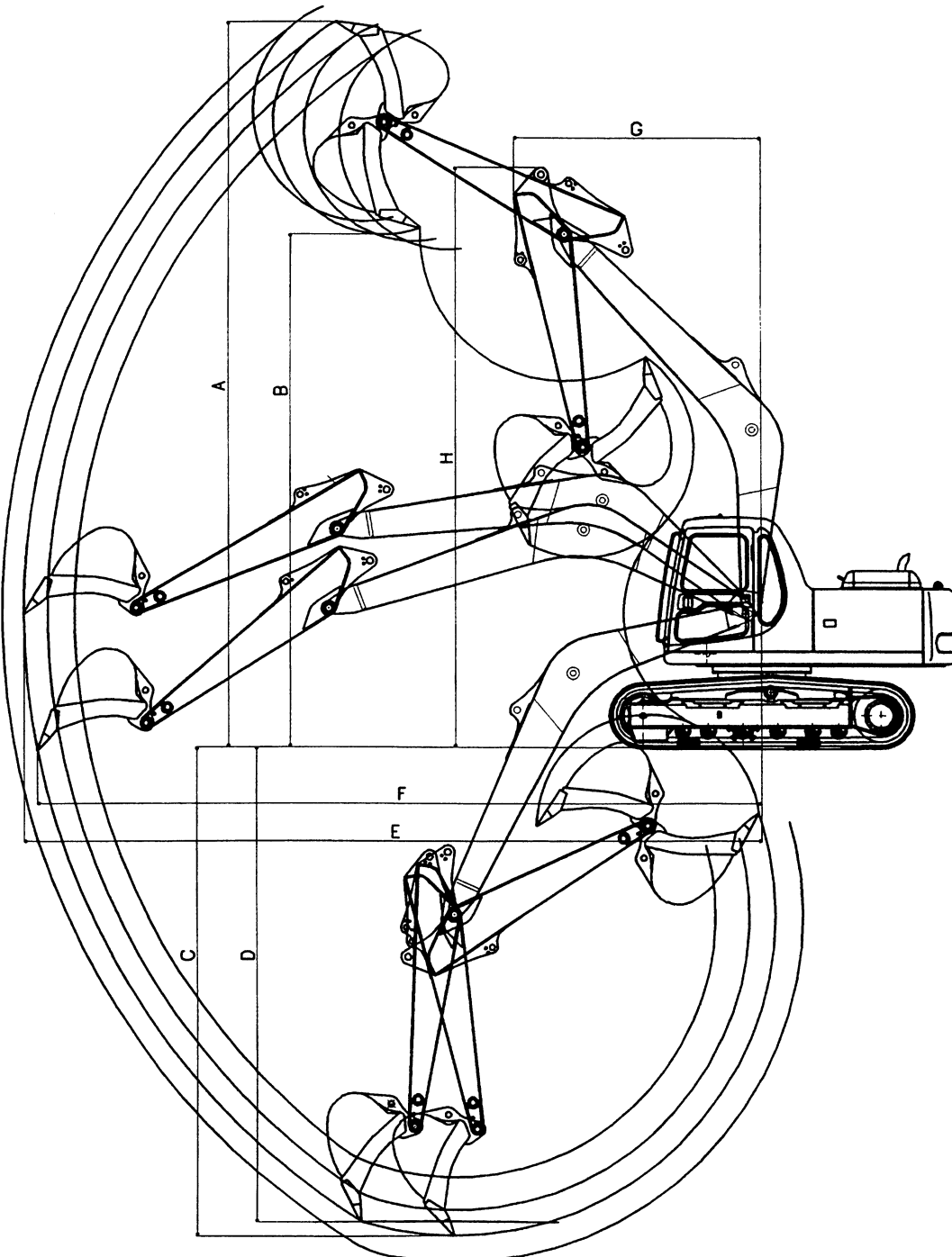

25. SPECIFICATIONS

PC180LC-6k, PC180NLC-6k

		1.85m ARM	2.25m ARM	2.62m ARM	2.9m ARM
A	Max. digging height	8775 mm	8840 mm	8900 mm	9055 mm
B	Max. dumping height	6130 mm	6230 mm	6320 mm	6470 mm
C	Max. digging depth	5200 mm	5610 mm	5960 mm	6250 mm
D	Max. digging depth of cal for 8° level	4950 mm	5375 mm	5740 mm	6050 mm
E	Max. digging reach	8355 mm	8675 mm	8960 mm	9230 mm
F	Max. digging reach at ground	8180 mm	8510 mm	8800 mm	9075 mm
G	Min swing radius	3360 mm	3060 mm	3000 mm	3010 mm
H	Work equipment height at min swing radius	7210 mm	7140 mm	7120 mm	7140 mm

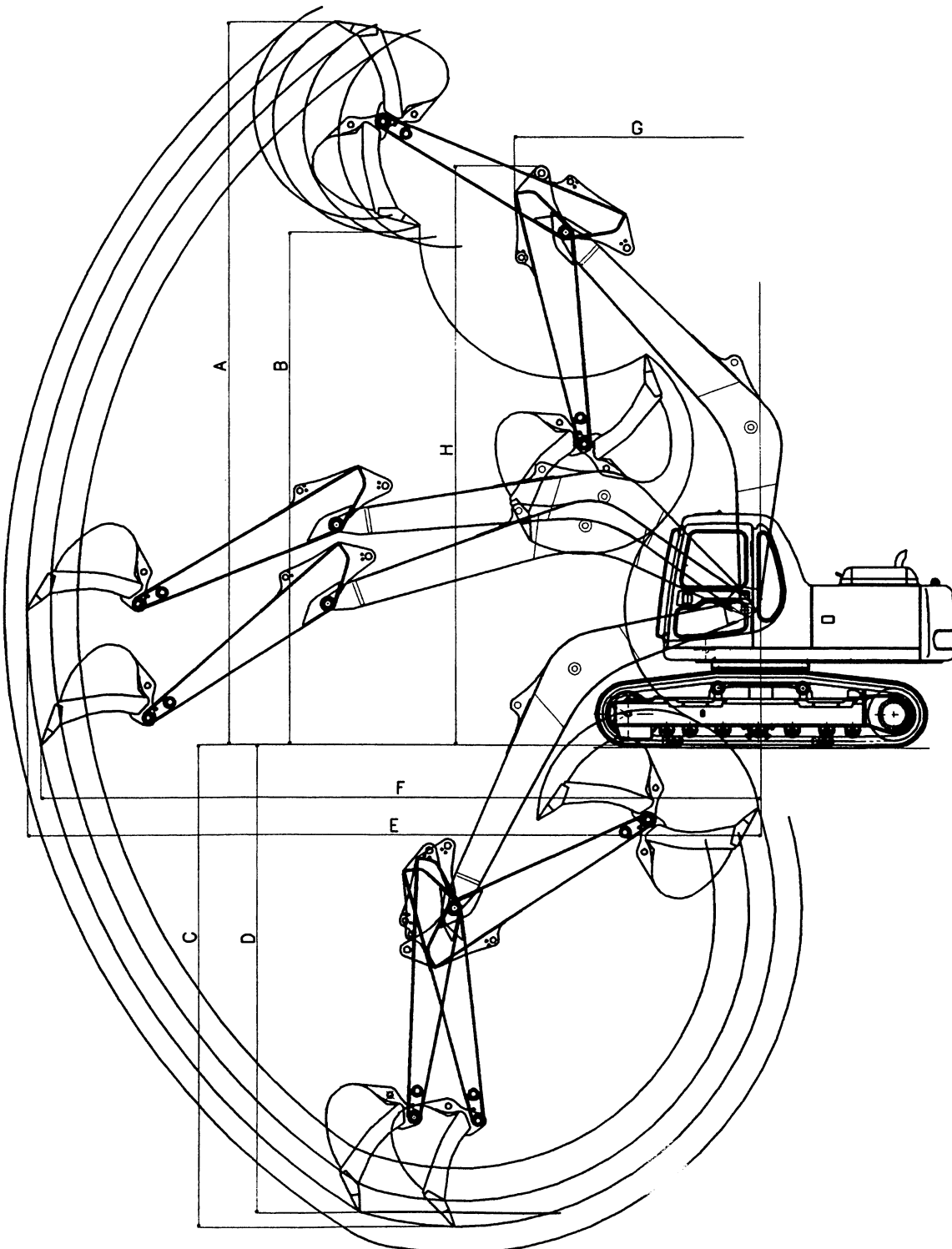

25. SPECIFICATIONS

PC200EN, PC200EL-6

	1.85m ARM	2.25m ARM	2.62m ARM	2.9m ARM
A	8860 mm	8800 mm	8800 mm	8805 mm
B	3125 mm	2960 mm	2965 mm	3055 mm
C	6040 mm	5135 mm	4750 mm	4555 mm

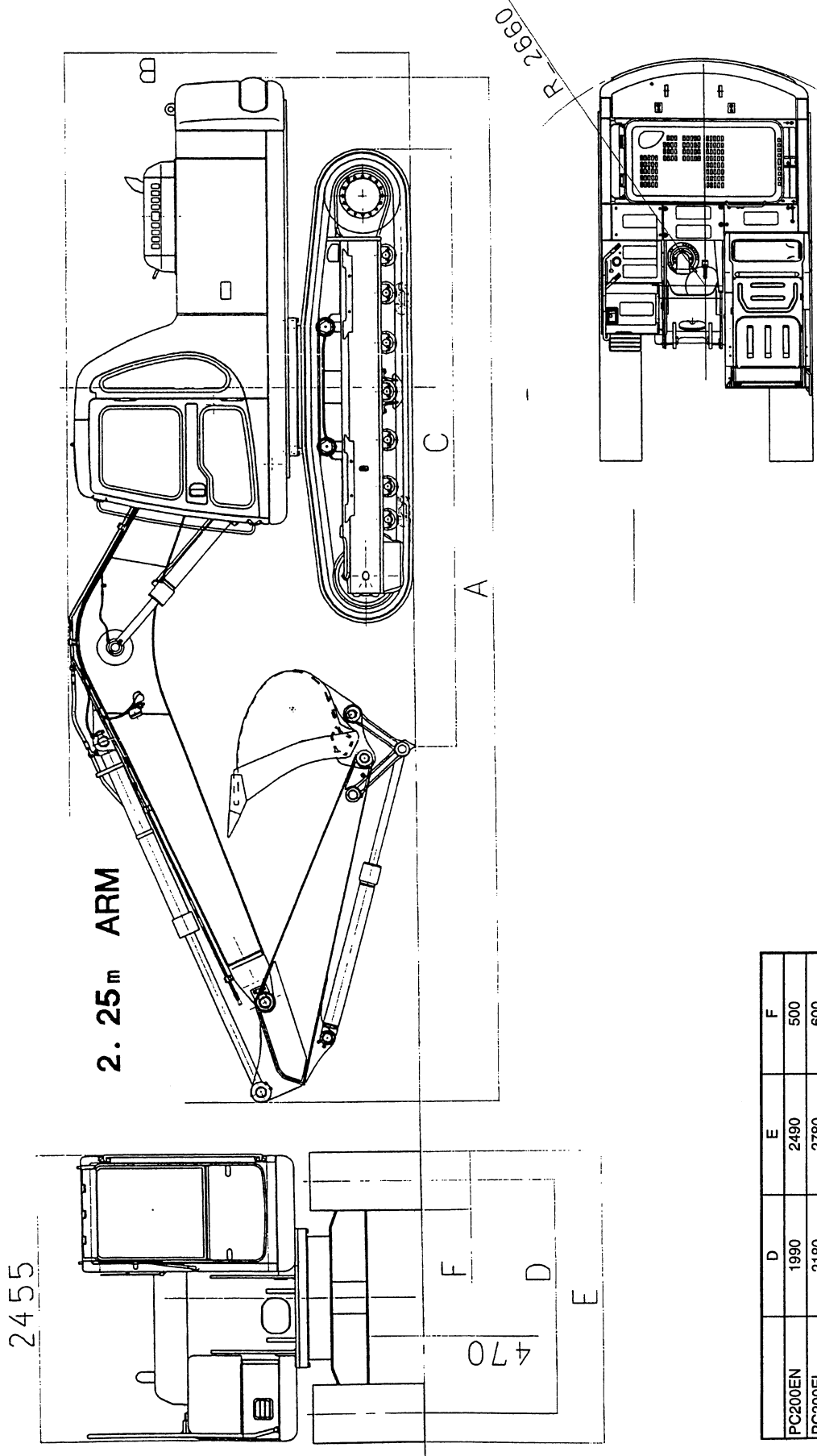

	D	E	F
PC200EN	1990	2490	500
PC200EL	2180	2780	600

25. SPECIFICATIONS

PC200EN,EL-6K

		1.85m ARM	2.25m ARM	2.62m ARM	2.9m ARM
A	Max. digging height	8775 mm	8840 mm	8900 mm	9055 mm
B	Max. dumping height	6130 mm	6230 mm	6320 mm	6470 mm
C	Max. digging depth	5200 mm	5610 mm	5960 mm	6250 mm
D	Max. digging depth of cal for 8' level	4950 mm	5375 mm	5740 mm	6050 mm
E	Max. digging reach	8355 mm	8675 mm	8960 mm	9230 mm
F	Max. digging reach at ground	8180 mm	8510 mm	8800 mm	9075 mm
G	Min swing radius	3360 mm	3060 mm	3000 mm	3010 mm
H	Work equipment height at min swing radius	7150 mm	7080 mm	7060 mm	7080 mm

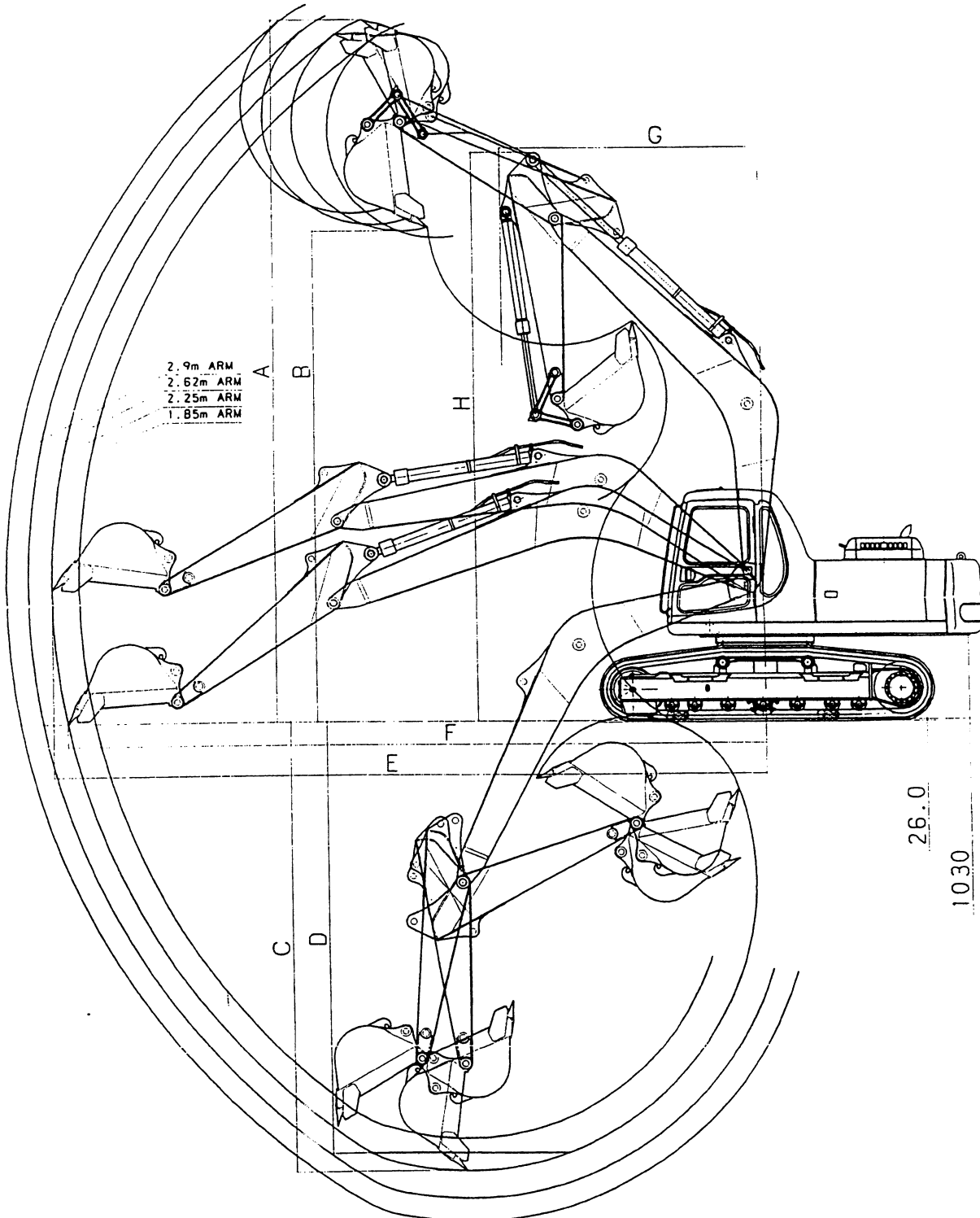

Lifting capacities PC160-6k

PC160-6K

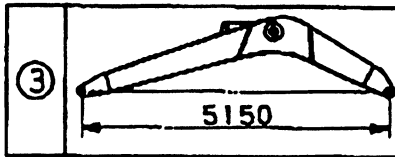
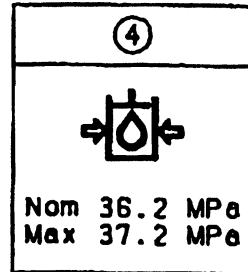
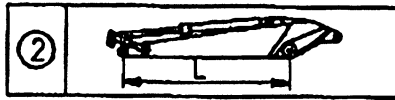
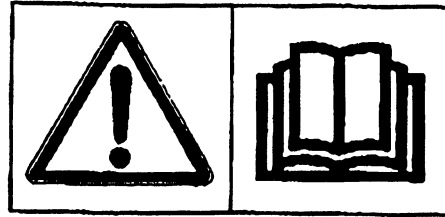
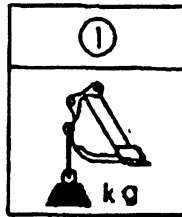
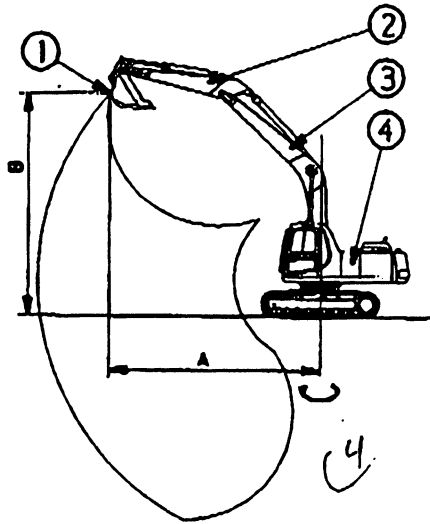

L	A	▲ 10												
		MAX		7.5m		8.0m		4.5m		3.0m		1.5m		
		☺	☹	☺	☹	☺	☹	☺	☹	☺	☹	☺	☹	
PC 160	2.5m	8.0m	1500	1500			3050	2850						
		4.5m	1450	1450	2200	1750	3580	2780						
		3.0m	1500	1400	2500	1700	3800	2800	5000	4280	7150	7150		
		1.5m	1850	1300	2480	1600	3680	2400	5750	3800	8780	7100		
		0.0m	1900	1300	2350	1500	3400	2250	5380	3600	8750	6500		
		-1.5m	2250	1480	2300	1500	3300	2150	5200	3350	8780	8400	4750	4750
	2.0m	8.0m	1700	1700			3150	2780						
		4.5m	1850	1850			3700	2700						
		3.0m	1700	1800	2500	1850	3750	2550	5300	4200	7750	7780		
		1.5m	1900	1400	2400	1550	3580	2350	5580	3700	8780	8750		
		0.0m	2200	1400	2350	1500	3400	2200	5350	3500	8400	8400		
		-1.5m	2400	1850			3300	2150	5200	3350	9100	8450	5050	5050
1.5m	8.0m	2100	2100			3200	2700							
	4.5m	2050	1850			3850	2700	4500	4800					
	3.0m	2100	1800	2450	1850	3700	2550	5850	4100	8750	7850			
	1.5m	2300	1500	2400	1600	3500	2350	6800	3700					
	0.0m	2350	1550	2350	1550	3400	2250	5700	3450	6780	5700			
	-1.5m	2850	1700			3300	2200	5250	3400	9350	8480	6300	5300	

PC180LC-6k

PC180LC-6K

①

②

④

Nom 36.2 MPa
Max 37.2 MPa

③

21P-00-K1030

PC180NLC-6K,

PC180NLC-6k

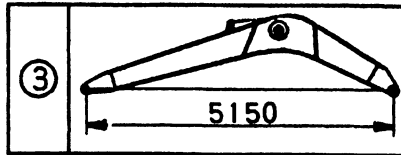
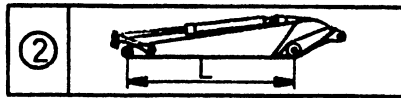
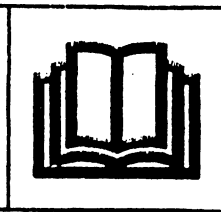
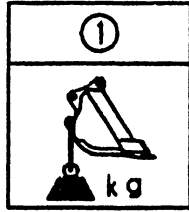
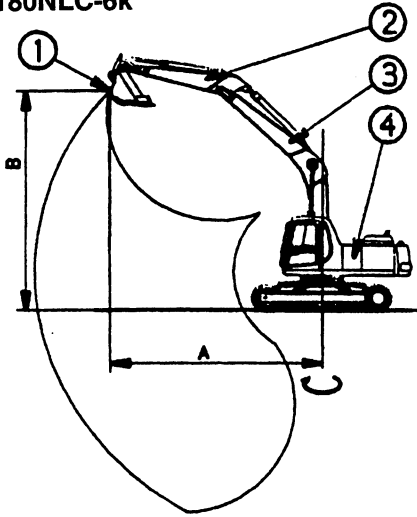

④

Nom 36.2 MPa
Max 37.2 MPa

L	A \ B	kg											
		MAX		7.5m		6.0m		4.5m		3.0m		1.5m	
		☺	☹	☺	☹	☺	☹	☺	☹	☺	☹	☺	☹
2.9m	8.0m	1500	1500			3050	2950						
	4.5m	1450	1450	2200	1850	3550	2900						
	3.0m	1500	1500	3200	1800	4050	2750	5000	4450	7150	7150		
	1.5m	1850	1400	3100	1700	4500	2550	8300	4050	8750	7500		
	0.0m	1900	1400	3000	1850	4300	2400	8900	3700	8750	8750		
	-1.5m	2350	1550	2950	1800	4200	2300	8750	3550	8750	8800	4750	4750
	-3.0m	3250	1900			4250	2300	8750	3550	10350	8900	7800	7800
	-4.5m	4100	2850					5350	3850	8000	7200		
	8.0m	1700	1700			3150	2900						
	4.5m	1850	1850			3700	2850						
	3.0m	1700	1800	3100	1750	4250	2700	5300	4400	7750	7750		
	1.5m	1900	1500	3050	1700	4450	2500	8450	3900	8750	8750		
0.0m	2200	1500	3000	1800	4300	2350	8900	3700	8400	8400			
-1.5m	2750	1850			4250	2300	8750	3550	9100	8800	5050	5050	
-3.0m	3850	2100			4250	2300	8800	3800	9950	8950	8300	8300	
-4.5m	4150	3300					4900	3800	7300	7300			
2.2m	8.0m	2100	2100			3200	2850						
	4.5m	2050	2000			4000	2800	4500	4500				
	3.0m	2100	1700	2550	1750	4450	2700	5850	4300	8750	8200		
	1.5m	2300	1800	3050	1700	4450	2500	8800	3900				
	0.0m	2850	1850	2700	1850	4300	2350	8850	3850	5700	5700		
	-1.5m	3250	1850			4250	2300	8750	3800	9350	8850	5300	5300
	-3.0m	4250	2350			4350	2400	8550	3850	9400	7050	9250	9250
	-4.5m	4000	3950							8250	8250		
	8.0m	3850	2900										
	4.5m	3450	2200			4350	2850	5000	4850				
	3.0m	3350	1900			4850	2700	8100	4250				
	1.5m	3200	1800			4500	2550	7150	3900				
0.0m	3300	1850			4350	2450	8900	3700					
-1.5m	3750	2100			4350	2400	8850	3700	9450	7000			
-3.0m	4450	2750					8200	3800	8790	7250			
-4.5m													

25. SPECIFICATIONS

PC200EL, PC200EN-6K

PC200EL/PC200EN-6K

①

②

④

Nom 36.2 MPa
Max 37.2 MPa

③

OPTIONS, ATTACHMENTS

26. GENERAL PRECAUTIONS

26.1 PRECAUTIONS RELATED TO SAFETY

If attachments or options other than those authorised by Komatsu are installed, this will not only affect the life of the machine, but will also cause problems with safety.

When installing attachments not listed in this Operation and Maintenance Manual, please contact your Komatsu distributor first.

If you do not contact Komatsu, we cannot accept any responsibility for any accident or failure.

WARNING

Precautions for removal and installation operations

When removing or installing attachments, obey the following precautions and take care to ensure safety during the operation.

- Carry out the removal and installation operations on a flat, firm ground surface.
- When the operation is carried out by two or more workers, determine signals and follow these during the operation.
- When carrying heavy objects (more than 25 kg (55 lb)), use a crane.
- When removing heavy parts, always support the part before removing it.
When lifting such heavy parts with a crane, always pay careful attention to the position of the centre of gravity.
- It is dangerous to carry out operations with the load kept suspended. Always set the load on a stand, and check that it is safe.
- When removing or installing attachments, make sure that they are in a stable condition and will not fall over.
- Never go under a load suspended from a crane.
Always stand in a position that is safe even if the load should fall.

NOTICE

Qualifications are required to operate a crane. Never allow the crane to be operated by unqualified person.

For details of the removal and installation operations, please contact your Komatsu distributor.

26.2 PRECAUTIONS WHEN INSTALLING ATTACHMENTS

WARNING

Long work equipment reduces the stability of the chassis, so if the swing is operated on a slope, or when going down a steep hill, the machine may lose its balance and overturn. The following operations are particularly dangerous, so never operate the machine in these ways.

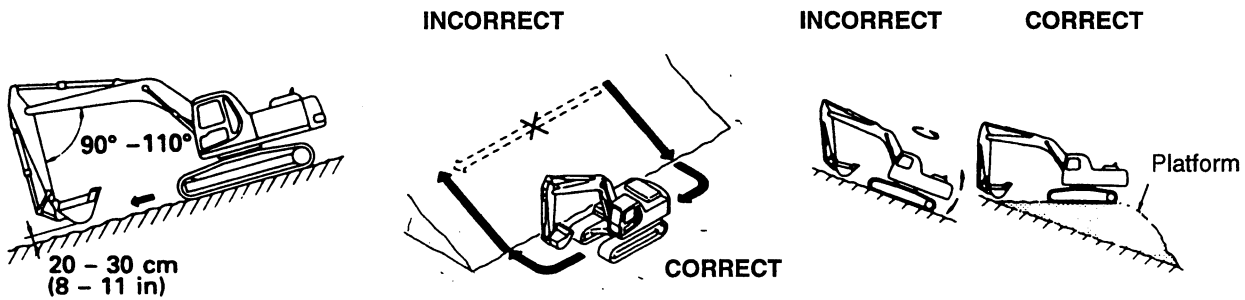

- If heavy work equipment is installed, the overrun of the swing becomes greater (the distance from the point where the operator operates the control levers to stop the swing to the point where the upper structure stops completely), so there is danger of mistaking the distance and hitting some thing.
Always operate so that there is an ample margin to the stopping point.
Furthermore, the hydraulic drift also becomes larger when the work equipment is stopped in mid-air, it will gradually move down under its own weight).
- Always follow the correct procedure when installing the boom and arm. If the correct procedure is not followed, this may lead to serious damage or injury, so please consult your Komatsu distributor before carrying out installation.

If long work equipment is installed, the working range will suddenly become larger, so there is danger of mistaking the distance and hitting something.
Always operate the work equipment so that there is ample space from any obstacles in the area

27. HANDLING BUCKET WITH HOOK

27.1 CHECKING FOR DAMAGE TO BUCKET WITH HOOK

Check that there is no damage to the hook, stopper, or hook mount. If any abnormality is found, please contact your Komatsu distributor.

27.2 PROHIBITED OPERATIONS

The standard work equipment must not be used for lifting loads. If this machine is to be used for lifting loads, it is necessary to install the special bucket with hook.

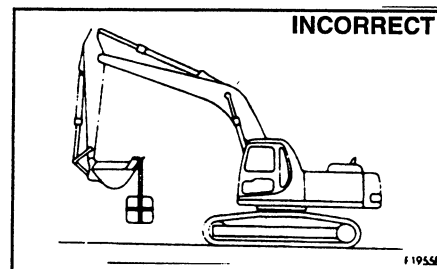

27.3 PRECAUTIONS DURING OPERATIONS

- When carrying out lifting operations, reduce the engine speed and use the lifting operation mode.
- Depending on the posture of the work equipment, there is danger that the wire or load may slip off the hook. Always be careful to maintain the correct hook angle to prevent this from happening.
- Never steer the machine while lifting a load.
- If the bucket with hook is turned and used for operations, it will hit the arm during dumping operations, so be careful when using it.
- The loads must never exceed those specified in the lifting capacity chart when carrying out lifting operations.
- If you wish to install a hook in the future, please contact your Komatsu distributor.

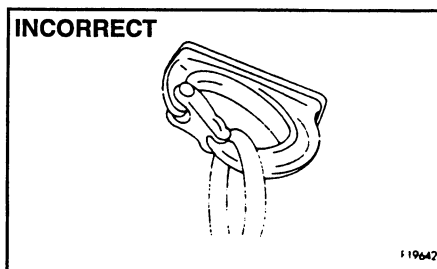
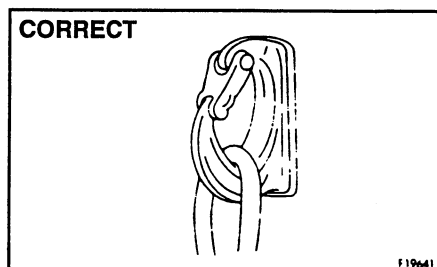

28. MACHINES READY FOR ATTACHMENTS

28.1 EXPLANATION OF COMPONENTS

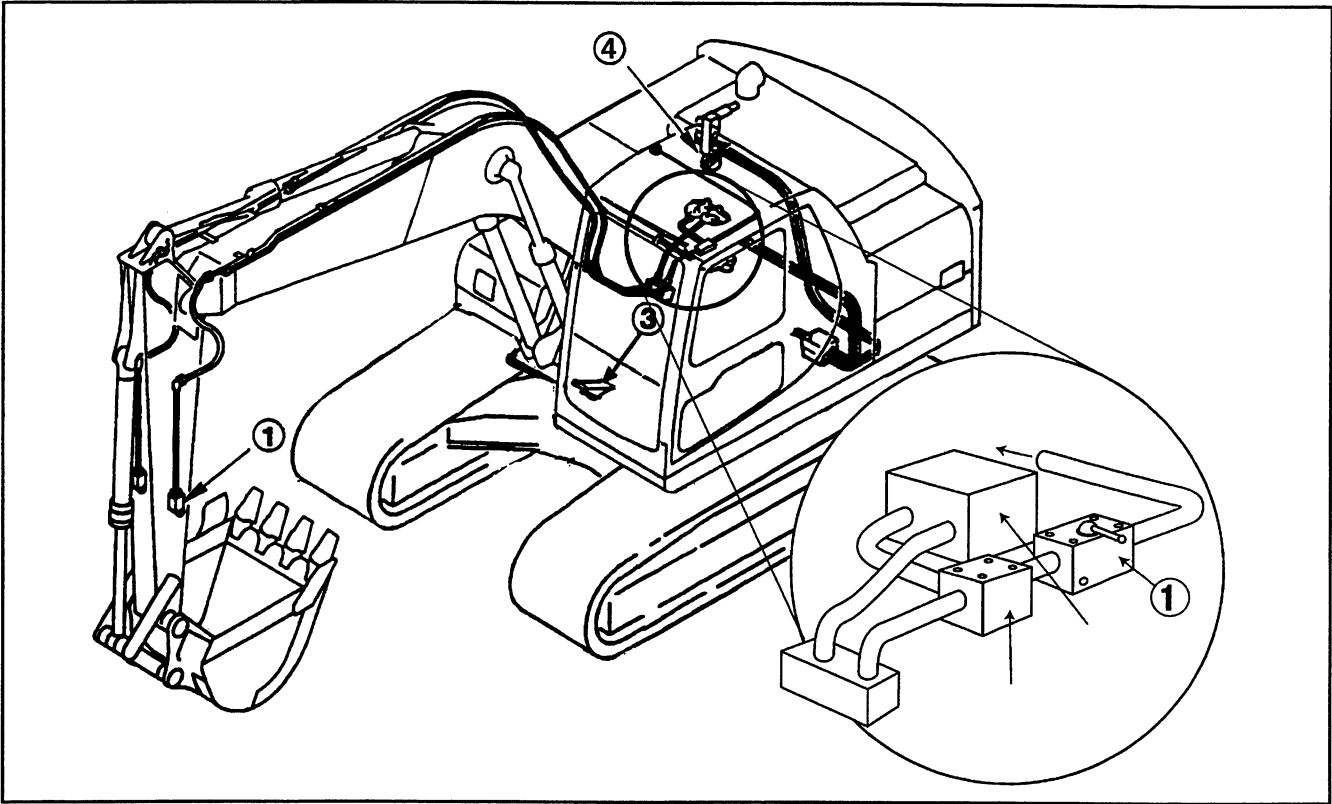

1. STOP VALVE

This valve stops the flow of the hydraulic oil.

① FREE : Hydraulic oil flows.

② LOCK : Hydraulic oil stops.

When removing or installing attachments set this valve to the LOCK position.

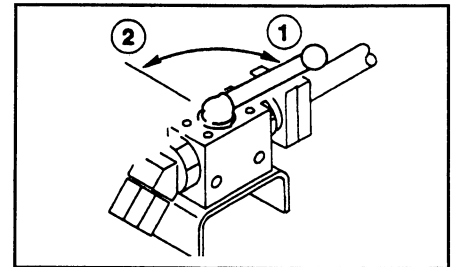

3. ATTACHMENT CONTROL PANEL

This is used to operate the attachment.

When the operator depresses the pedal at the front, neutral or rear portions, the attachment moves as follows.

Hydraulic breaker

- Pedal front ① : actuated
- Pedal neutral ② : stopped
- Pedal rear ③ : stopped

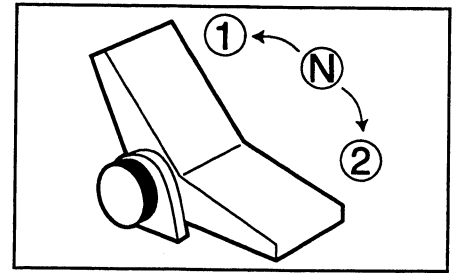

For other attachments, confirm with the manufacturer regarding the relation between pedal operation and attachment movement when the attachment is mounted. Use the attachment only after confirming the above.

4 LOCK PIN

This is used to lock the control pedal.

Screw pin ① into hole inside of pedal to lock.

Screw pin ① out the hole to unlock.

- When the breaker is used, select the breaker operation mode (B.O.) in the monitor and use the pedal with pin in unlocked position.

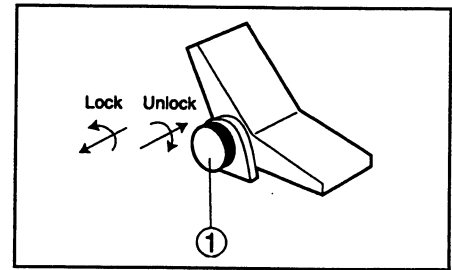

5. ACCUMULATOR

WARNING

The accumulator is filled with high-pressure nitrogen gas, and it is extremely dangerous if it is handled mistakenly. For details of handling, see 11.18 "HANDLING ACCUMULATOR".

This is installed to release any remaining pressure in the attachment circuit after the engine is stopped. Normally, do not touch it.

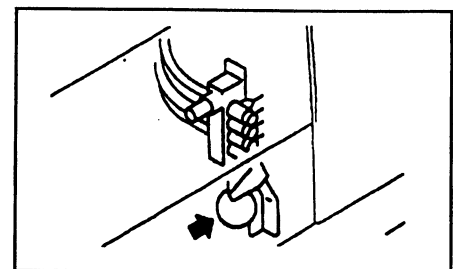

28.2 HYDRAULIC CIRCUIT

Change-over hydraulic circuit

When the machine is equipped with an attachment or a bucket, set stop valve as follows

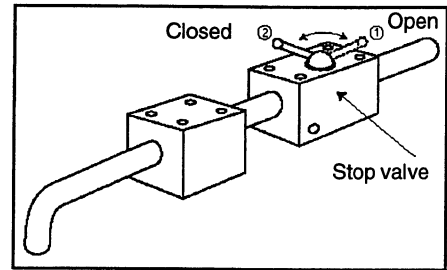

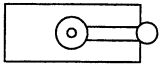
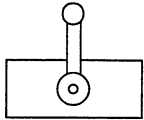
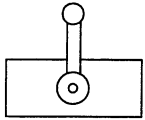
Attachment	Stop valve
Breaker etc.	 OPEN
Crusher etc.	 CLOSED
When not used	 CLOSED

NOTICE

- The set pressure of the relief valve is set to 24500 kPa (250 kg/cm², 3550 psi) as standard when delivered from the factory. If a breaker by another manufacturer is installed, adjustment is required. Consult your Komatsu distributor.

28.2.1 CONNECTING HYDRAULIC CIRCUIT

When connecting the attachment, connect the circuit as follows.

1. Remove blind plugs ① located on the end of the stop valve piping (2 places, left and right).
Take care not to lose or damage the removed parts.
2. Connect attachment tubes ② supplied by the attachment manufacturer to the end from which the plug was removed in step 1.

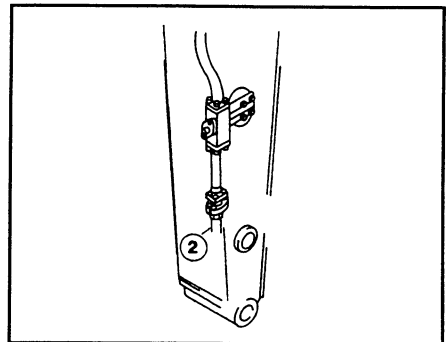
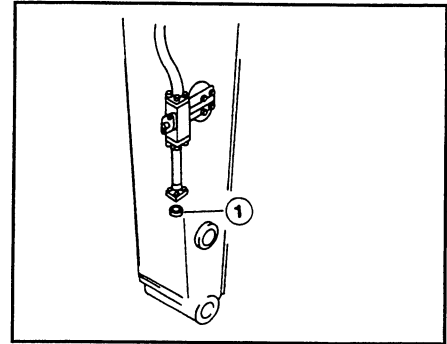

PATH OF OIL

The direction of operation of the pedal and the path of the oil are as shown in the diagram below.

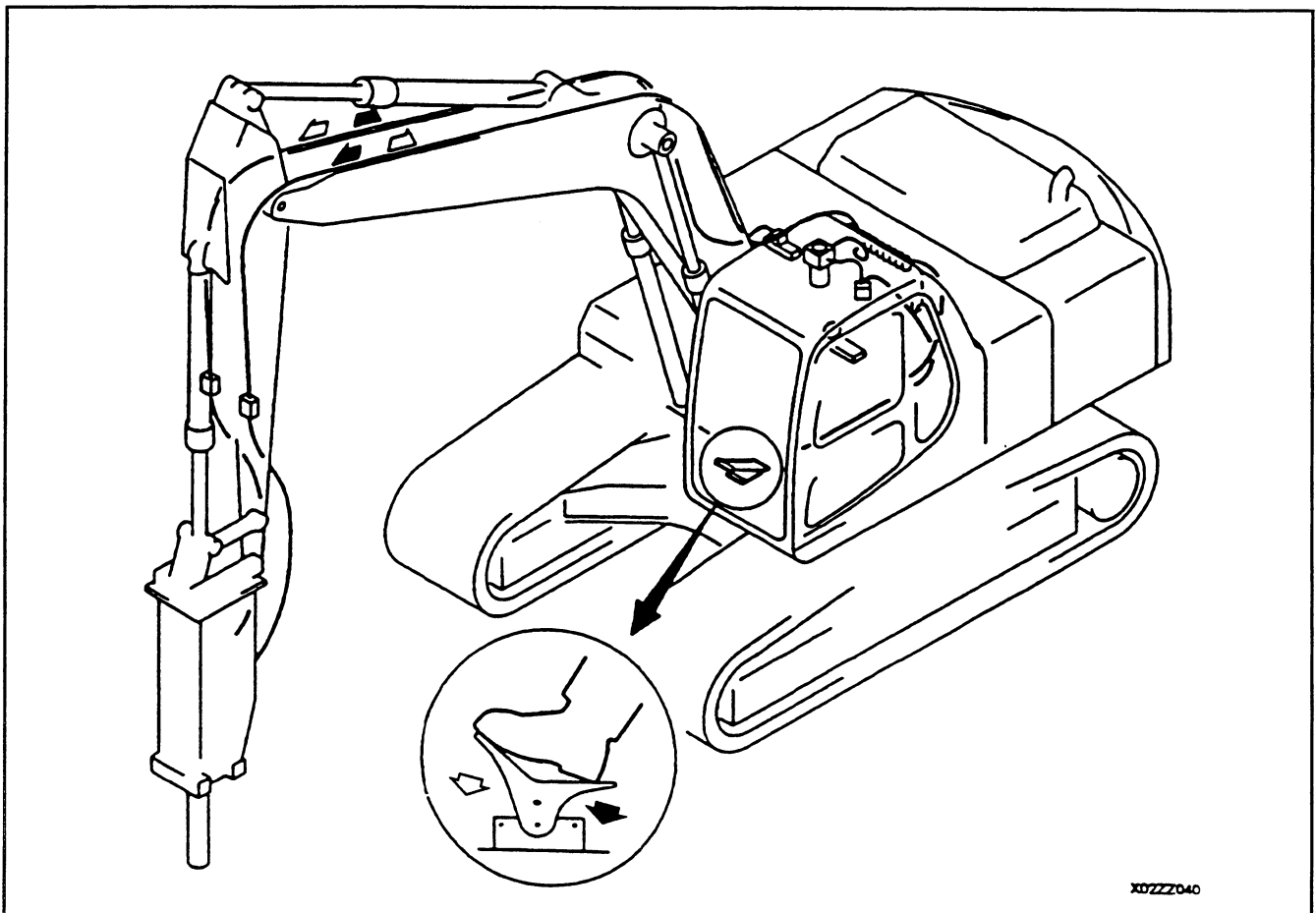

28.3. ATTACHMENT MOUNTING/DISMOUNTING PROCEDURE

DISMOUNTING PROCEDURE

1. Place the attachment on the ground and stop the engine.
2. After stopping the engine, operate each work equipment control lever and the attachment control pedal back and forth, left and right at full stroke 2 to 3 times to eliminate the internal pressure in the hydraulic circuit.

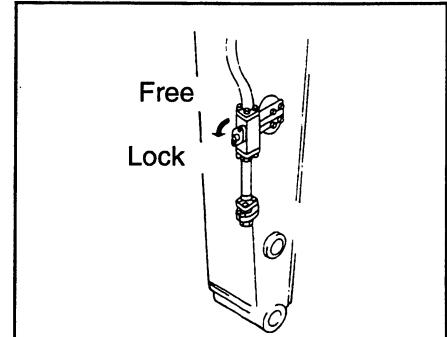

3. After confirming low oil temperature, turn the rotor of the stop valve connected to the inlet and outlet piping on the arm side face to the lock position.
4. Remove the hoses on the attachment side. Install the blind plugs to the two outlets.

The blind plugs are used to prevent the entry of dust or dirt into the hydraulic system which may cause defective operation of the attachment.

After the plugs are correctly installed, store the attachment.

5. Dismount the attachment by removing the retaining pins (2 pins). Then, mount the bucket. For the bucket mounting procedure, see 12.15 "REPLACEMENT AND INVERSION OF BUCKET".
6. After the bucket is mounted, check the hydraulic oil level.

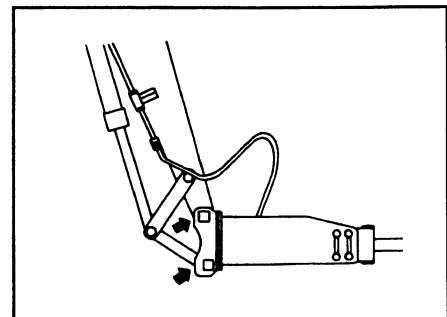

28. MACHINES READY FOR ATTACHMENTS

MOUNTING PROCEDURE

1. Remove the bucket.

For bucket dismounting procedure, see 12.15 "REPLACEMENT AND INVERSION OF BUCKET".

2. Place the attachment on a flat place, install pins Ⓐ and Ⓑ to the arm in that order.
3. After mounting the attachment, stop the engine. Operate each work equipment control lever and the attachment control pedal to full stroke back and forth, right and left to eliminate the internal pressure in the hydraulic circuit.
4. After confirming low oil temperature, remove the blind plug from the outlet and inlet port respectively.

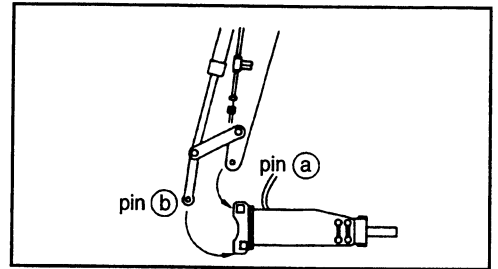

Take care that no dust, mud, etc. adheres to the hose mouthpiece portions.
If O-ring is damaged, replace it with a new one.

5. Turn the rotor of the stop valve connected to the inlet and outlet piping on the arm side face to the free position.
6. Confirm that oil level in the hydraulic oil tank is correct, after mounting the attachment.

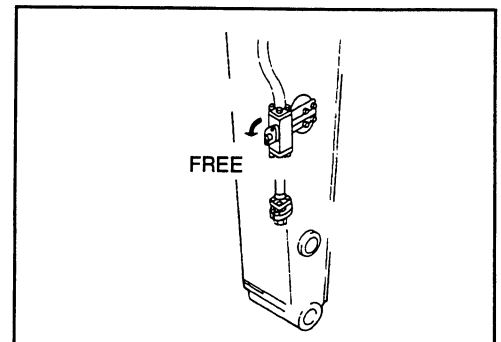

28.4 OPERATION

WARNING

- If the pedal is operated inside the deceleration range, the engine speed will rise suddenly. Be careful.
- If the operator rests his foot on the attachment pedal while operating the machine, if he carelessly depresses the pedal, the attachment may move suddenly and result in serious trouble. Never place your foot on the pedal except when actually performing pedal operation.

The operation of the attachment is as follows.

WHEN USING BREAKER

When the front portion of the pedal is depressed after the lock pin is set at the free position, the breaker is actuated.
select the working mode for breaker (B.O).

Precautions when using

- Check that the stop valve is at the FREE position.
- Check that the selector valve is at the position for using the breaker.

For details of the oil path, see 28.2 "HYDRAULIC CIRCUIT".

- Consult with the attachment manufacturer as to whether the accumulator is required for the attachment circuit or not.
- For other precautions when using the breaker, see the instruction manual provided by the breaker manufacturer.
- When the breaker is used, the hydraulic oil degrades faster than in normal operation. Shorten the maintenance interval of the hydraulic oil and filter element.

See 23.2 "MAINTENANCE INTERVAL WHEN USING HYDRAULIC BREAKER".

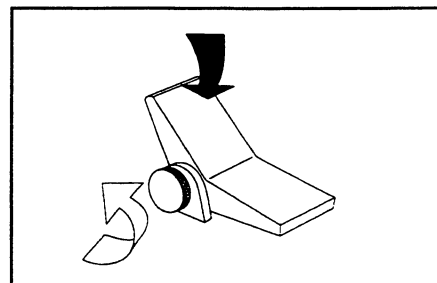

28. MACHINES READY FOR ATTACHMENTS

WHEN USING GENERAL ATTACHMENT SUCH AS CRUSHER

When the lock pin is set to the free position and the pedal is depressed at the front or rear portions, the attachment is actuated.

Precautions when using

- Check that the stop valve is at the FREE position.
- Confirm that the selector valve is set to the position for general attachments such as the crusher.

For details of the oil path, see 28.2 "HYDRAULIC CIRCUIT".

- For other precautions when using the attachment, see the instruction manual provided by the attachment manufacturer.

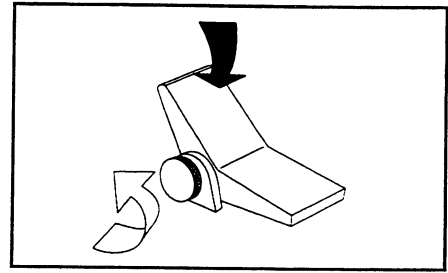

28.5 LONG TERM STORAGE

If the equipment is not to be used for a long period, do as follows.

- Set the stop valve to the LOCK position.
- Install the blind plugs and O-rings to the valves.
- Set the selector valve to the "when not use" position.
- Lock the lock pin to the lock position.

If the pedal is operated when there is no breaker or general attachment installed, it will cause overheating and other problems.

28.6 SPECIFICATIONS

Hydraulic specifications

- Max. oil flow: 206 l/min.
- Relief set pressure of service valve safety valve: (365 kg/cm²)
- Cracking pressure of service valve safety valve: (385 kg/cm²)

29. INTRODUCTION OF ATTACHMENTS

29.1 SPECIFICATION, USE

- PC160-6k

Name	Specifications, use
Narrow bucket	Capacity 0.57 m ³ Outside width 900 mm
Narrow bucket	Capacity 0.64 m ³ Outside width 960 mm
Light duty bucket	Capacity 0.80 m ³ Outside width 1,050 mm
Light duty bucket	Capacity 1.00 m ³ Outside width 1,350 mm
Shape finishing bucket	Capacity 0.35 m ³ Compacting width 2,000 mm ³ Compacting area 2,4 m ²
Trapezoidal bucket	Capacity 0.50 m ³ Outside width
Ripper bucket	Capacity 0.56 m ³ Outside width 990 mm
One tooth ripper	Shank width 118 mm Crushing depth 1,130 mm
Three teeth ripper	Shank width 118 mm Crushing depth 860 mm
Track shoes	Triple grouser shoe width 500 mm Triple grouser shoe width 600 mm Triple grouser shoe width 700 mm Triple grouser shoe width 800 mm
Short arm	Arm length 1,850 mm Max. digging depth 5,240 mm
Short arm	Arm length 2,250 mm Max. digging depth 5,645 mm
Medium arm	Arm length 2,600 mm Max. digging depth 6,000 mm
Long arm	Arm length 2,900 mm Max. digging depth 6,290 mm
Head guard	In place where there is danger of falling rocks, always install the head guard to protect the operator.

29. INTRODUCTIONS OF ATTACHMENTS

- **PC180NLC-6k, PC180LC-6k**

Name	Specifications, use
Narrow bucket	Capacity 0.57 m ³ Outside width 900 mm
Narrow bucket	Capacity 0.64 m ³ Outside width 960 mm
Light duty bucket	Capacity 0.80 m ³ Outside width 1,050 mm
Light duty bucket	Capacity 1.00 m ³ Outside width 1,350 mm
Shape finishing bucket	Capacity 0.35 m ³ Compacting width 2,000 mm ³ Compacting area 2,4 m ²
Trapezoidal bucket	Capacity 0.50 m ³ Outside width
Ripper bucket	Capacity 0.56 m ³ Outside width 990 mm
One tooth ripper	Shank width 118 mm Crushing depth 1,130 mm
Three teeth ripper	Shank width 118 mm Crushing depth 860 mm
Track shoes	Triple grouser shoe width 500 mm Triple grouser shoe width 600 mm Triple grouser shoe width 700 mm Triple grouser shoe width 800 mm
Short arm	Arm length 1,850 mm Max. digging depth 5,200 mm
Short arm	Arm length 2,250 mm Max. digging depth 5,645 mm
Medium arm	Arm length 2,600 mm Max. digging depth 5,960 mm
Long arm	Arm length 2,900 mm Max. digging depth 6,290 mm
Head guard	In place where there is danger of falling rocks, always install the head guard to protect the operator.

- **PC200EN-6k/PC200EL-6k**

Name	Specifications, use
Narrow bucket	Capacity 0.57 m ³ Outside width 900 mm
Narrow bucket	Capacity 0.64 m ³ Outside width 960 mm
Light duty bucket	Capacity 0.80 m ³ Outside width 1,050 mm
Light duty bucket	Capacity 1.00 m ³ Outside width 1,350 mm
Shape finishing bucket	Capacity 0.35 m ³ Compacting width 2,000 mm ³ Compacting area 2,4 m ²
Trapezoidal bucket	Capacity 0.50 m ³ Outside width
Ripper bucket	Capacity 0.56 m ³ Outside width 990 mm
One tooth ripper	Shank width 118 mm Crushing depth 1,130 mm
Three teeth ripper	Shank width 118 mm Crushing depth 860 mm
Track shoes	Triple grouser shoe width 500 mm Triple grouser shoe width 600 mm Triple grouser shoe width 700 mm Triple grouser shoe width 800 mm
Short arm	Arm length 1,850 mm Max. digging depth 5,200 mm
Short arm	Arm length 2,250 mm Max. digging depth 5,645 mm
Medium arm	Arm length 2,600 mm Max. digging depth 5,960 mm
Long arm	Arm length 2,900 mm Max. digging depth 6,290 mm
Head guard	In place where there is danger of falling rocks, always install the head guard to protect the operator.

29.2 ATTACHMENT INSTALLATION COMBINATION TABLE

PC160/PC180-6/PC200EN/PC200EL

This table lists the combination of attachments which can be installed to the standard short arms.

- Can be used.
- △ Can be used only for light duty work
- x Cannot be used.

NOTICE

- When the extension arm is equipped, if the bucket is drawn to the machine body, the arm interferes with the body. Operate the extension arm carefully.
- When the boom is fully lowered during oblique digging, the boom interferes with the undercarriage. Operate the boom carefully.

Categories of use

For general digging : digging or loading sand, gravel, clay etc.

For light duty digging : digging or loading dry, uncaked earth and sand, mud etc.

For loading work : loading dry, loose earth and sand

- For digging or loading hard soil or soft rock, it is recommended that the strengthened bucket with high durability and wear resistance be used.

Name of bucket	Capacity (m ³)	Outside width (mm)	Use	Standard Boom (6470 mm)			
				Standard arm (2.6m)	Short arm (2.25 m)	Short (1.8 m)	Long (2.9 m)
* Narrow bucket	0.57	900	Narrow digging	○	○	○	○
* Narrow bucket	0.69	960	Narrow digging	○	○	○	○
* Standard bucket	0.80	1,050	General digging	○	○	○	△
* Light duty bucket	1.00	1,350	Loading	△	△	△	x
Slope finishing bucket	0.35	2000	Shape finishing	○	○	○	△
Trapezoidal bucket	0.50	610	Trapezoidal shape ditching	○	○	○	△
Ripper bucket	0.56	990	Digging rocks	○	○	○	x
One tooth ripper	NA		Digging, removing rocks	○	○	○	x
Three teeth ripper	NA		Digging, removing rocks	○	○	○	x

29.3 SELECTION OF TRACK SHOES

Select suitable track shoes to match the operating conditions.

METHOD OF SELECTING SHOES

Confirm the category from the list of uses in Table 1, then use Table 2 to select the shoe.

- Categories B and C are wide shoes, so there are limitations on their use. When using these shoes, check the precautions, then investigate and study fully the conditions of use to confirm that these shoes are suitable.
- When selecting the shoe width, select the narrowest shoe possible that will give the required flotation and ground pressure. If a wider shoe than necessary is used, the load on the track will increase, and this will cause the shoes to bend, links to crack, pins to break, shoe bolts to come loose, and various other problems.

Table 1

Category	Use	Precautions when using
A	Rocky ground, riverbeds, normal soil	<ul style="list-style-type: none"> • On rough ground with large obstacles such as boulders or fallen trees, travel at low speed.
B	Normal soil, soft ground	<ul style="list-style-type: none"> • These shoes cannot be used on rough ground where there are large obstacles such as boulders or fallen trees. • Travel at Hi speed only on flat ground, and if it is impossible to avoid going over obstacles, shift down and travel at half speed in Lo.
C	Extremely soft ground (swampy ground)	<ul style="list-style-type: none"> • Use the shoes only in places where the machine sinks and it is impossible to use A or B shoes. • These shoes cannot be used on rough ground where there are large obstacles such as boulders or fallen trees. • Travel at Hi speed only on flat ground, and if it is impossible to avoid going over obstacles, shift down and travel at half speed in Lo.

Table 2

	PC160-6k/PC180NLC-6k/PC200EN-6k		PC180LC-6K/PC200EL-6k	
	Specifications	Category	Specifications	Category
Standard	500 triple grouser	A	600 triple grouser	B
Optional	600 triple grouser	B	700 triple grouser	A
Optional	700 triple grouser	C	800 triple grouser	C

29.4 SELECTION OF BUCKET TEETH

Select suitable bucket teeth to match the operating conditions.

METHOD OF SELECTING TEETH

The standard teeth can be used over a wide range, but according to the operating conditions, we recommend the following teeth.

Long-life teeth

- Jobsites where wear life is demanded, such as when loading hard rocks.
- Jobsites where no penetration is needed, such as when working with crushed rock after blasting or ripping.
- Jobsites where heavy-duty operations are carried out, such as hitting or pulling up rocks with the tips of the teeth.

Self-sharpening teeth

- Jobsites demanding penetration such as digging and loading sandy or clayey soil.

29.5 HANDLING TRAPEZOIDAL BUCKET

This bucket is used to dig trapezoidal ditches on paddy fields, farmland ect. and can dig 3 types of ditch gradients (45°, 40° and 38°) when a movable plate is attached.

- The mounting position of the movable plate varies depending on whether the ditch gradient is 45°, 40° or 38°.

How to perform excavation

Operate the boom, the arm and the bucket to make the line ① of the side-plate of the bucket vertical.

The guide plate ② to check this position is installed beside the bucket pins. Accordingly, hold this plate horizontal when digging.

Ditch gradient of 45°

Attached the bucket only or the movable plate by selecting the related ditch holes. Perform digging by the above method.

Ditch gradient of 40° or 38°

Attached the bucket only or the movable plate by selecting the related ditch holes. Perform digging by the above method.

Even if the trapezoidal bucket is provided with the movable plate, always perform digging with the bucket side face perpendicular to the ground.

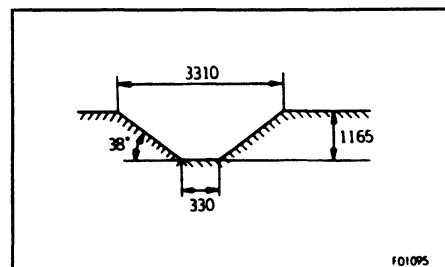
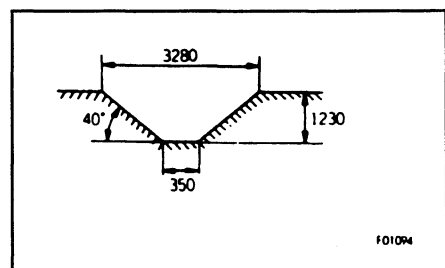
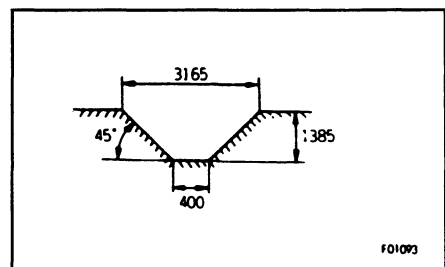
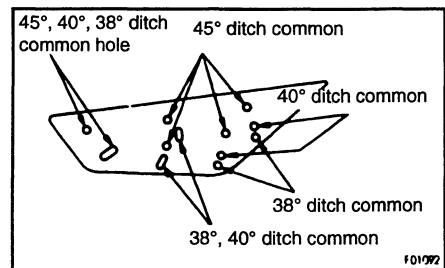
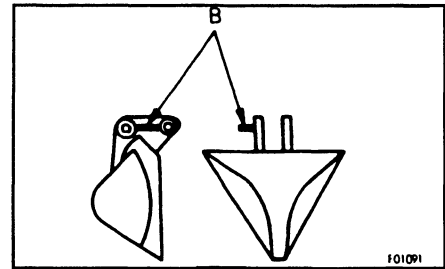
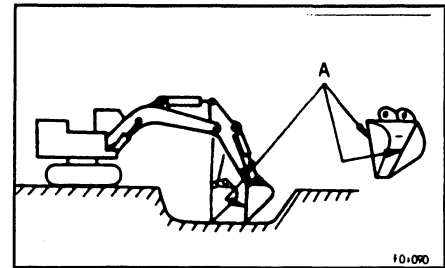

29.6 HANDLING THE CLAMSHELL BUCKET

This bucket is used for digging and loading in side-ditches or the confined spaces.

How to perform excavation

This clamshell digs by pushing the boom against the ground.

However, when perform bucket operation, perform digging while gradually raising the boom.

If the clamshell bucket rotates, relieve the bucket cylinder pressure then set the lever to the neutral position. This can temporally stop the rotation.

PRECAUTIONS WHEN USING.

- For safety, always avoid abrupt travelling, swing and stopping.
- Make the teeth of the bucket vertical in digging.
- Do not swing the bucket to crush the rock or to cut through soil.
- Do not use the bucket for hammering or pulling out piles etc.
- Before leaving the machine, open the bucket and lower it to the ground.

REMARKS

Remove the bucket from the arm when transporting the machine.

30. EXTENDING MACHINE SERVICE LIFE

This section describes the necessary precautions to be observed when operating a hydraulic excavator equipped with an attachment.

NOTICE

Select the attachment most suited to the machine body.

- The machine models to which attachments can be mounted vary. For selection of attachment and machine model, consult your Komatsu distributor.

30.1 HYDRAULIC BREAKER

MAIN FIELDS OF APPLICATION

- Crushed rock
- Demolition work
- Road construction

This attachment can be used for a wide range of work including demolition of buildings, breaking up of road surfaces, tunnel work, breaking up slag, rock crushing, and breaking operations in quarries.

Keep the chisel pushed perpendicularly against the impact surface when carrying out breaking operations.

When applying impact, push the chisel against the impact surface and operate so that the chassis rises approx. 5 cm (2 in) off the ground. Do not let the machine come further off the ground than necessary.

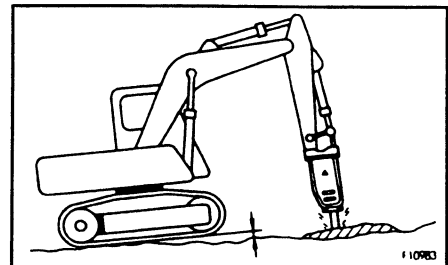
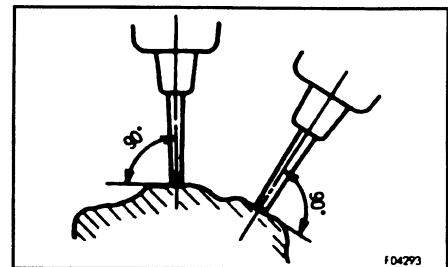
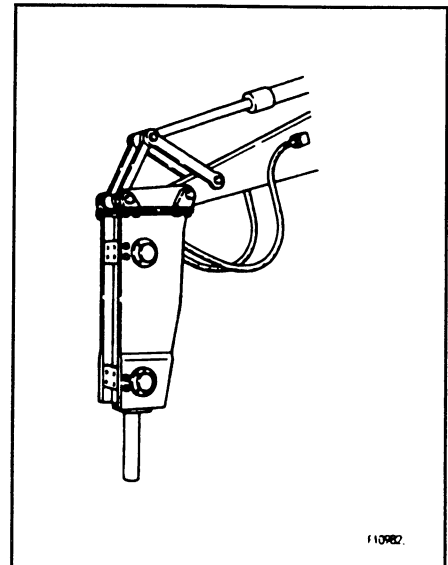

30. EXTENDING MACHINE SERVICE LIFE

When applying continuous impact to the same impact surface, if the chisel does not penetrate or break the surface within 1 minute, change the point of impact and carry out breaking operations closer to the edge.

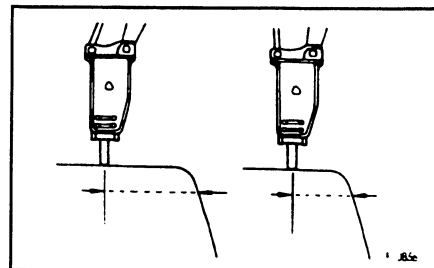

The direction of penetration of the chisel and the direction of the breaker body will gradually move out of line with each other, so always adjust the bucket cylinder to keep them aligned.

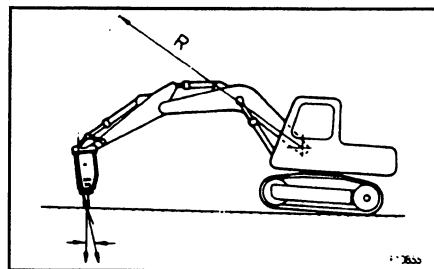

Always keep the chisel pressed against the impact surface properly to prevent using the impact force when there is no resistance.

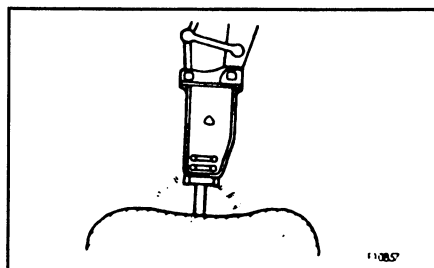

MISTAKEN METHODS OF USE

To ensure that the machine has a long life, and to ensure that operations are carried out in safety, do not operate the machine in any of the following ways.

- Do not operate the cylinder to the end of its stroke. Always leave approx. 5 cm (2 in) to spare.

Using the mount to gather in pieces of rock

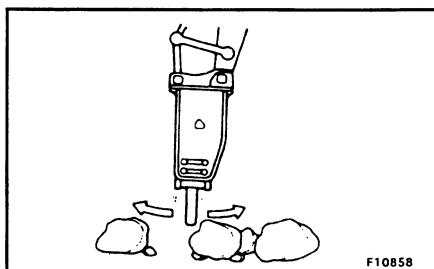

Operations using the swing force

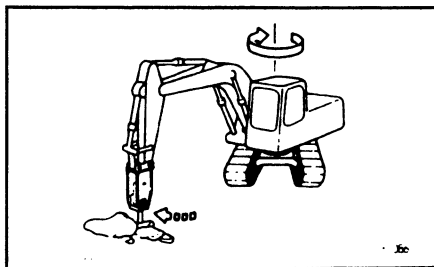

Moving the chisel while carrying out impacting operations

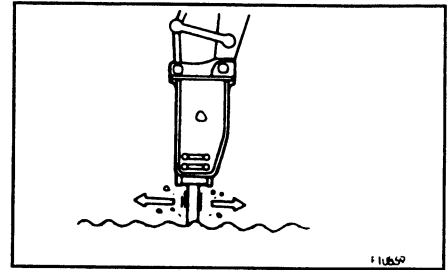

Holding the chisel horizontal or pointed up when carrying out impacting operations

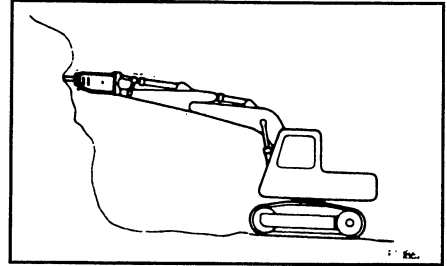

Twisting the chisel when it has penetrated the rock

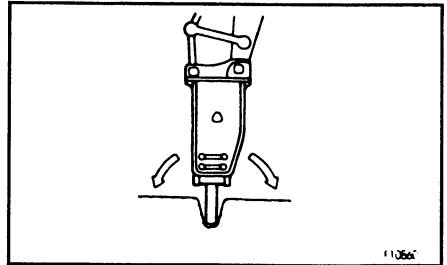

Pecking operations

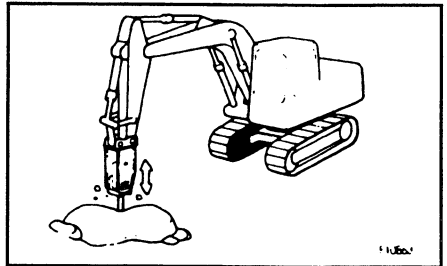

Extending the bucket cylinder fully and thrusting to raise the machine off the ground

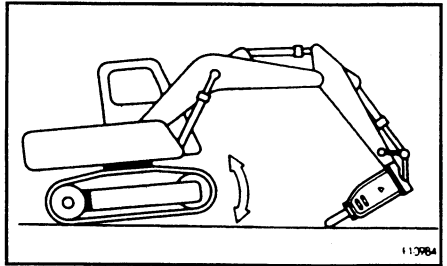

30.2 POWER RIPPER

MAIN FIELDS OF APPLICATIONS

- Road repair work
- Demolition work

This attachment can be used for a wide range of work including peeling off and crushing pavement roads, demolishing wooden houses and buildings, and crushing foundation and roadbeds.

MISTAKEN METHODS OF USE

To ensure that the machine has a long life, and to ensure that operations are carried out in safety, do not operate the machine in any of the following ways.

- Do not operate the cylinder to the end of its stroke. Always leave approx. 5 cm (2 in) to spare.

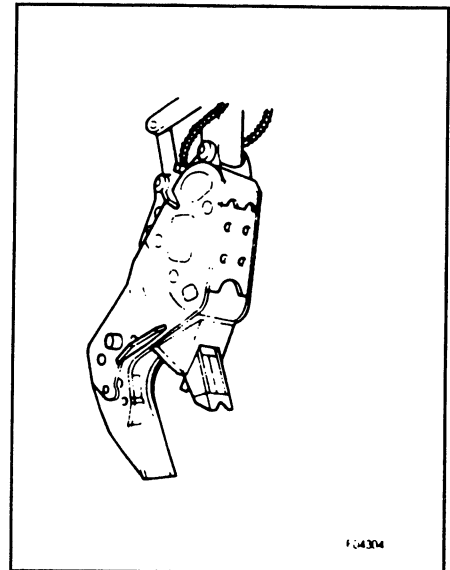

Impact operations using attachment

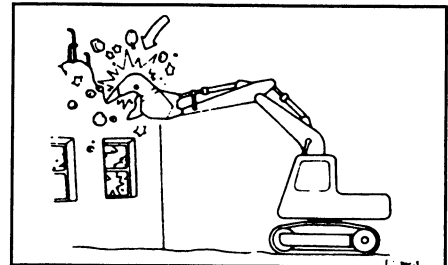

Impact operations using swing force

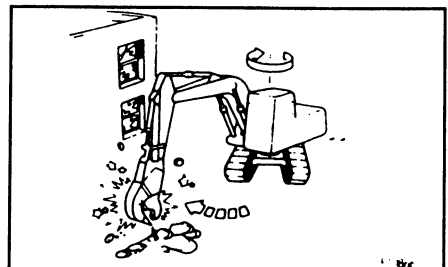

Overloading work equipment during lifting and loading operations

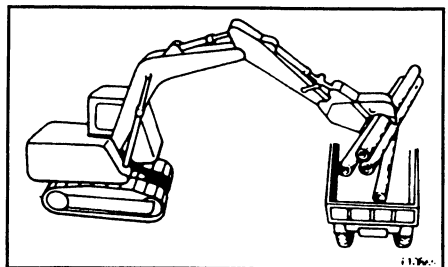

Operations using attachment to grip at an angle

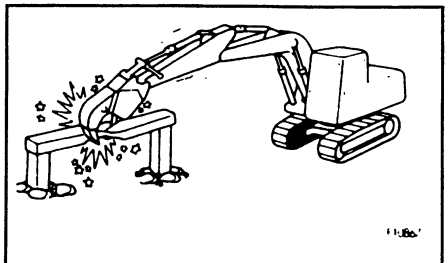

30.3 FORK GRAB

MAIN FIELDS OF APPLICATION

- Disposing of industrial waste
- Disposing of demolition waste

This can be used for a wide range of work including collecting or loading demolition waste materials and debris, timber, grass.

MISTAKEN METHODS OF USE

To ensure that the machine has a long life, and to ensure that operations are carried out in safety, do not operate the machine in ' any of the following ways.

- Do not operate the cylinder to the end of its stroke.
Always leave approx. 5 cm (2 in) to spare.

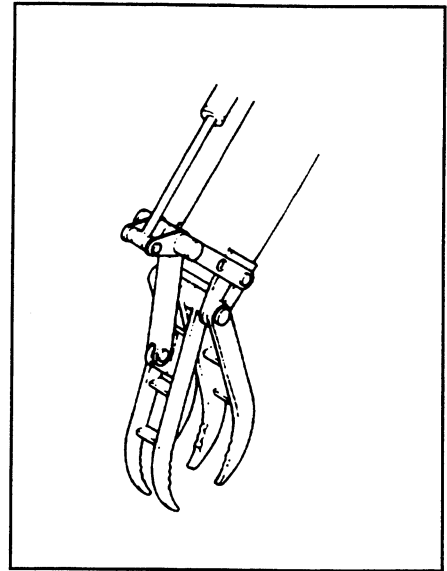

Operations using the swing force

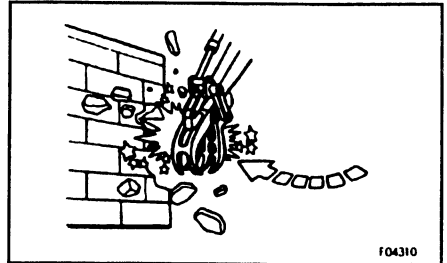

Operations using one side of work equipment

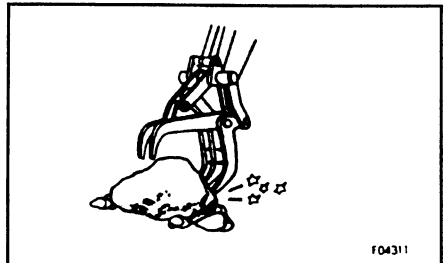

Pushing fork into ground surface to jack up and change direction of machine

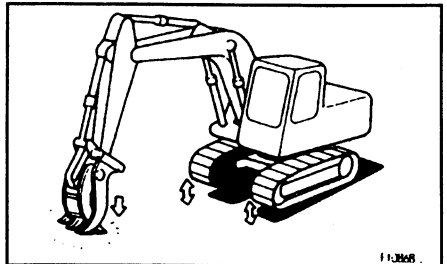

Impact operation with no load



30.4 GRAPPLE BUCKET

MAIN FIELDS OF APPLICATION

- Demolition
- Disposing of industrial waste
- Forestry

This bucket is widely used for demolition including breaking-up work, grading and digging, clean-up work after natural disasters, dumping industrial waste, and forestry work, etc.

MISTAKEN METHODS OF USE

To ensure that the machine has a long life, and to ensure that operations are carried out in safety, do not operate the machine in any of the following ways.

Do not operate the cylinder to the end of its stroke. Always leave approx. 5 cm (2 in) to spare.

Operations using the swing force

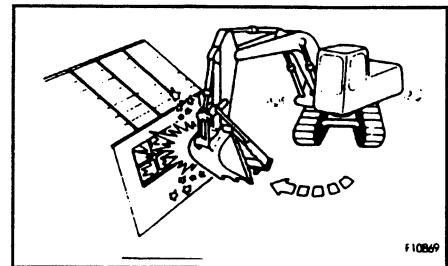
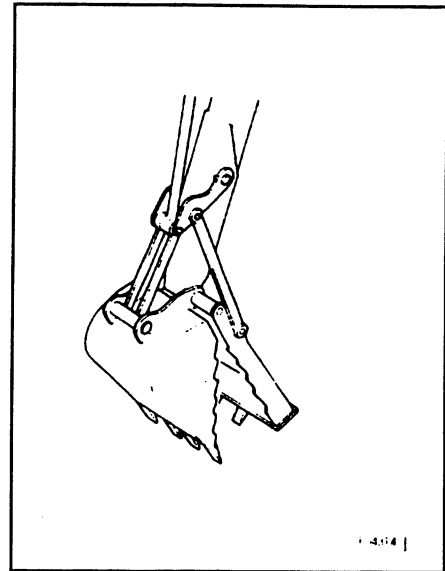

Grabbing a object using buckets on only one side

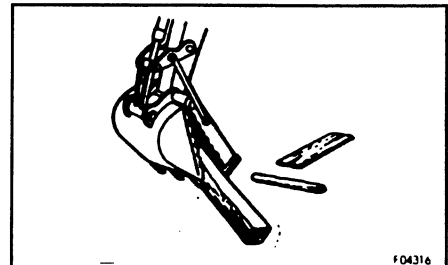

Closing the sub-bucket with the boom and arm fully extended.

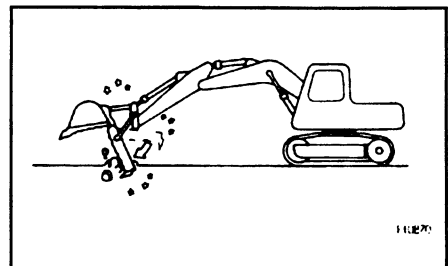

Impact operation with no load

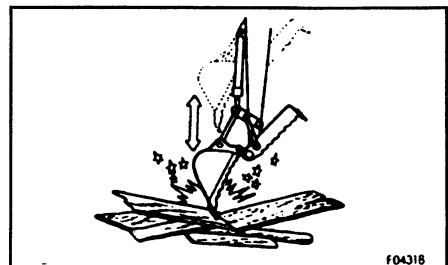

30.5 SCRAP GRAPPLE

MAIN FIELDS OF APPLICATION

- Disposal of rock or debris

This attachment is mounted to the arm end and used to grasp rock, debris etc. by opening and closing the claws (3 to 5) corresponding to the extension and retraction of the hydraulic cylinder.

MISTAKEN METHODS OF USE

To ensure that the machine has a long life, and to ensure that operations are carried out in safety, do not operate the machine in any of the following ways.

- Do not operate the cylinder to the end of its stroke. Always leave approx. 5 cm (2 in) to spare.

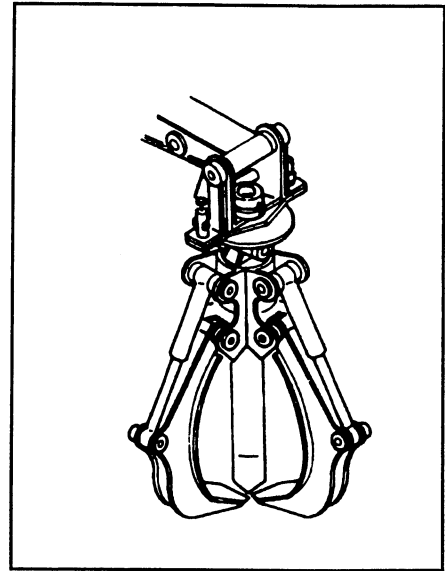

Operations using the swing force

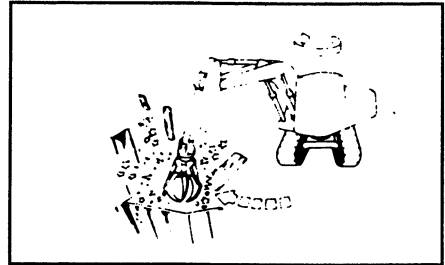

Operations using one side of work equipment

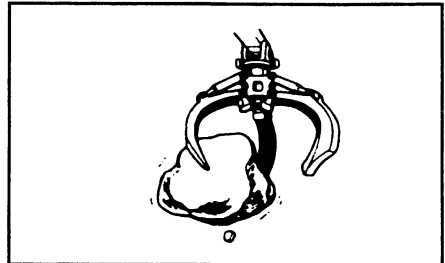

Catching and dragging with claw end

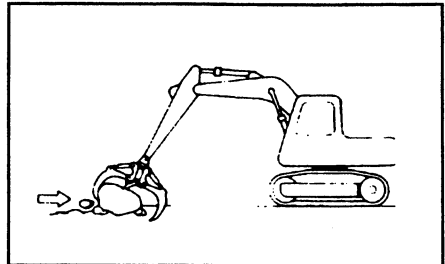

Gouging

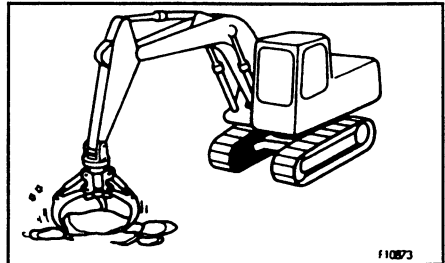

30.6 CRUSHER & SMASHER

MAIN FIELDS OF APPLICATION

- Demolition
- Road repair work

This is the optimum attachment for demolition of steel frame reinforced structures, and for crushing of concrete blocks and rock, etc. The unique blade shape provides heavy crushing power.

MISTAKEN METHODS OF USE

To ensure that the machine has a long life, and to ensure that operations are carried out in safety, do not operate the machine in any of the following ways.

- Do not operate the cylinder to the end of its stroke. Always leave approx. 5 cm (2 in) to spare.

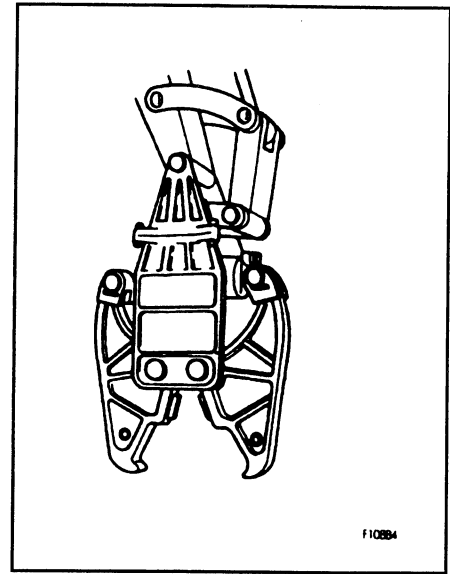

Operations using cutting tip on one side only

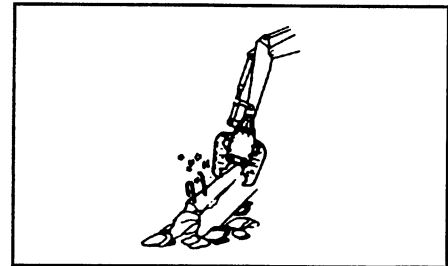

Impact operation with no load

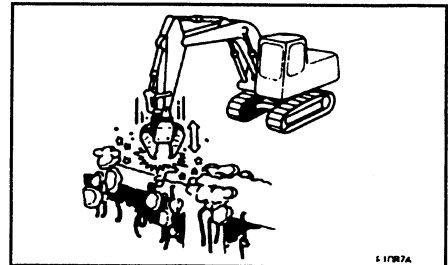

Twisting operations at end of cylinder stroke

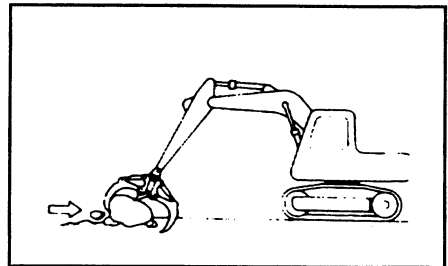

Sudden gripping and breaking operations

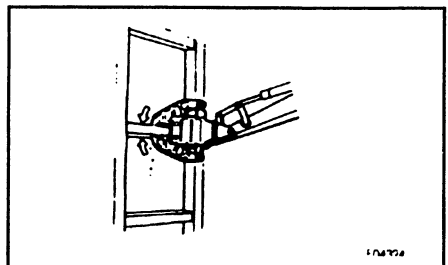

30.7 HYDRAULIC PILE DRIVER

MAIN FIELDS OF APPLICATION

- Foundation work
- River work
- Water supply and sewerage

This is a piling machine employing the hydraulic power source of the excavator. The machine features a long arm and a chuck unit. This facilitates operations such as driving and removing long piles, driving in piles at corners, etc.

MISTAKEN METHODS OF USE

To ensure that the machine has a long life, and to ensure that operations are carried out in safety; do not operate the machine in any of the following ways.

- Do not operate the cylinder to the end of its stroke. Always leave approx. 5 cm (2 in) to spare.

Forward or swing motion while grasping a pile

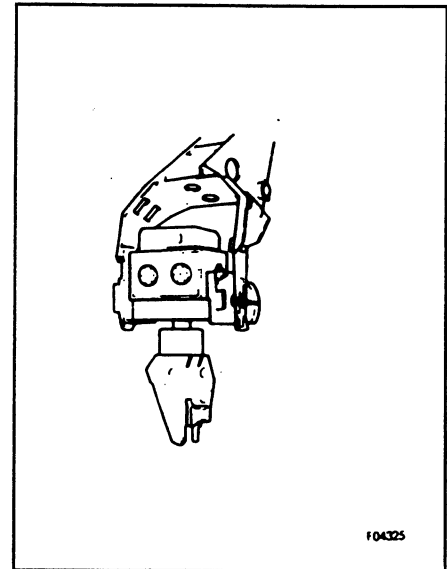

F04325

Lifting more than two piles at the same time

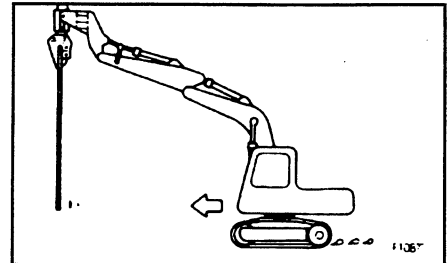

F1367

Work other than standard works

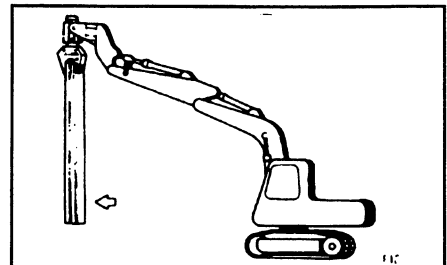

F11

Loading or unloading a machine equipped with hydraulic pile driver

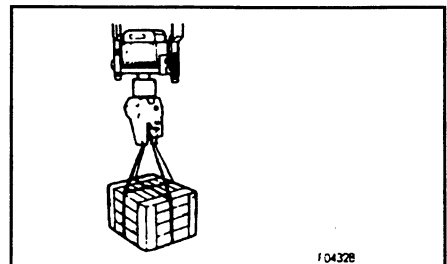

F04326

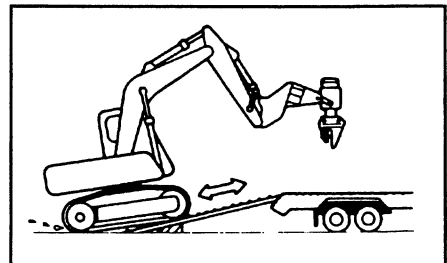

30.8 HYDRAULIC EXCAVATOR WITH MULTIPURPOSE CRANE

MAIN FIELDS OF APPLICATION

- Site preparation
- Water supply and sewerage
- River work
- Agricultural, civil engineering work

Crane operation can be carried out without removing the bucket. This machine is used for laying U section gutters and pipes for water supply and sewerage as well as river and canal work, agricultural, civil engineering work and site preparation.

MISTAKEN METHODS OF USE

To ensure that the machine has a long life, and to ensure that operations are carried out in safety, do not operate the machine in any of the following ways.

- Do not operate the cylinder to the end of its stroke. Always leave approx. 5 cm (2 in) to spare.

Abrupt lever operation

Travelling with a suspended load

Operating other work equipment during crane operation

Excessive lengthening of wire rope

