



Engine specifications & Injection pump datas

DIESEL ENGINE for INDUSTRIAL

D1146T

D1146TI

DE08TS

DE08TIS

D1146T/D1146TI/DE08TS/DE08TIS Engine specification & injection pump data for excavator

1.1. Engine Specifications

1.1.1. Specification

Engine Model		D1146T	DE08TS	D1146TI	DE08TIS
Items					
Engine type		4 cycle in-line, Water-cooled type, Turbo charged		4 cycle in-line, Water-cooled type Turbo charged & intercooled	
Combustion chamber type		Direct injection type			
Cylinder liner type		Replaceable dry liner			
Timing gear system		Gear driven type			
No. of piston ring		Compression ring 2, oil ring 1			
No. of cylinder-bore x stroke (mm)		6 – 111 × 139			
Total piston displacement (cc)		8,071			
Compression ratio		16.7 : 1	19.5 : 1	16.7 : 1	19.5 : 1
Engine dimension(length x width x height) (mm)		1,222 x 786 x 1159	1,166 x 727 x 1159	1,123 x 815 x 1,166	1,269.5 x 891 x 1,182
Engine weight (kg)		720	800	560	800
Rotating direction (viewed from flywheel)		Counter clockwise			
Fuel injection order		1 – 5 – 3 – 6 – 2 – 4			
Injection pump type		Bosch in-line type			
Governor type		Mechanical governor type (RSV)			
Injection nozzle type		Multi-hole type			
Fuel injection pressure (kg/cm ²)		Refer to injection pump rack data			
Compression pressure (kg/cm ²)		28 (at 200 rpm)			
Intake and exhaust valve clearance (at cold) (mm)		0.3			
Intake valve	Open at	16° (B.T.D.C)			
	Close at	36° (A.B.D.C)			
Exhaust valve	Open at	46° (B.B.D.C)			
	Close at	14° (A.T.D.C)			
Lubrication method		Full forced pressure feed type			
Using engine oil		Above ACEA-E2 (API CH-4) , SAE15W40			
Oil pump type		Gear type driven by crankshaft			
Oil filter type		Paper element type		Cartridge type	
Lubricating oil capacity (max./min.) (lit)		21 / 17 or 31.5 / 20			
Oil cooler type		Water cooled			
Water pump		Centrifugal type driven by belt			
Cooling Method		Fresh water forced circulation			
Cooling water capacity (engine only) (lit)		11			
Thermostat type		Wax pallet type (71 ~ 85 °C or 71 ~ 90 °C)			
Alternator voltage – capacity (V – A)		24 – 50 (Option)			
Starting Motor voltage – output (V - kW)		24 – 6.0			
Air heater capacity (V – A)		Installed parts of vehicle maker			
Battery capacity (V - AH)		24 - 150			

D1146T/D1146TI/DE08TS/DE08TIS
Engine specification & injection pump data for excavator

1.1.2. Engine power

Production tolerance : ±5%

Engine model		Performance					
Model	Suffix	Injection timing (BTDC°)	Power (PS/rpm)	Torque (kg.m/rpm)	Low idle (rpm)	High idle (rpm)	Remark
D1146T	EADLA	12 ± 1	170 / 2,000	66 / 1,400	1,000	2,200	
	EADLB	14 ± 1	172 / 2,200	69 / 1,300	975	2,420	
	EADLC	12 ± 1	172 / 2,200	71 / 1,300	975	2,420	
	EADLE	12 ± 1	172 / 2,200	71 / 1,300	975	2,420	
D1146TI	EADLA	12 ± 1	200 / 1,900	80 / 1,400	1,000	2,090	
	EADLB	15 ± 1	205 / 1,900	88 / 1,300	1,050	2,090	
	EADLC	12 ± 1	185 / 1,900	75 / 1,400	1,000	2,200	
	EADLE	12 ± 1	200 / 1,900	88 / 1,300	1,050	2,090	
	EADLF	12 ± 1	200 / 1,900	80 / 1,400	1,000	2,090	
DE08TS	EADFA	9 ± 1	140 / 2,200	55 / 1,400	800	2,400	
	EADFB	9 ± 1	160 / 2,200	63 / 1,400	800	2,400	
DE08TIS	EADFA	6 ± 1	205 / 1,900	88 / 1,300	1,000	2,090	
	EADFB	7 ± 1	212 / 2,100	90 / 1,300	1,000	2,350	

* Note : All data are based on operation without cooling fan at ISO 1585(SAE J1349)

1.1.3. Performance curve (DE08TIS)

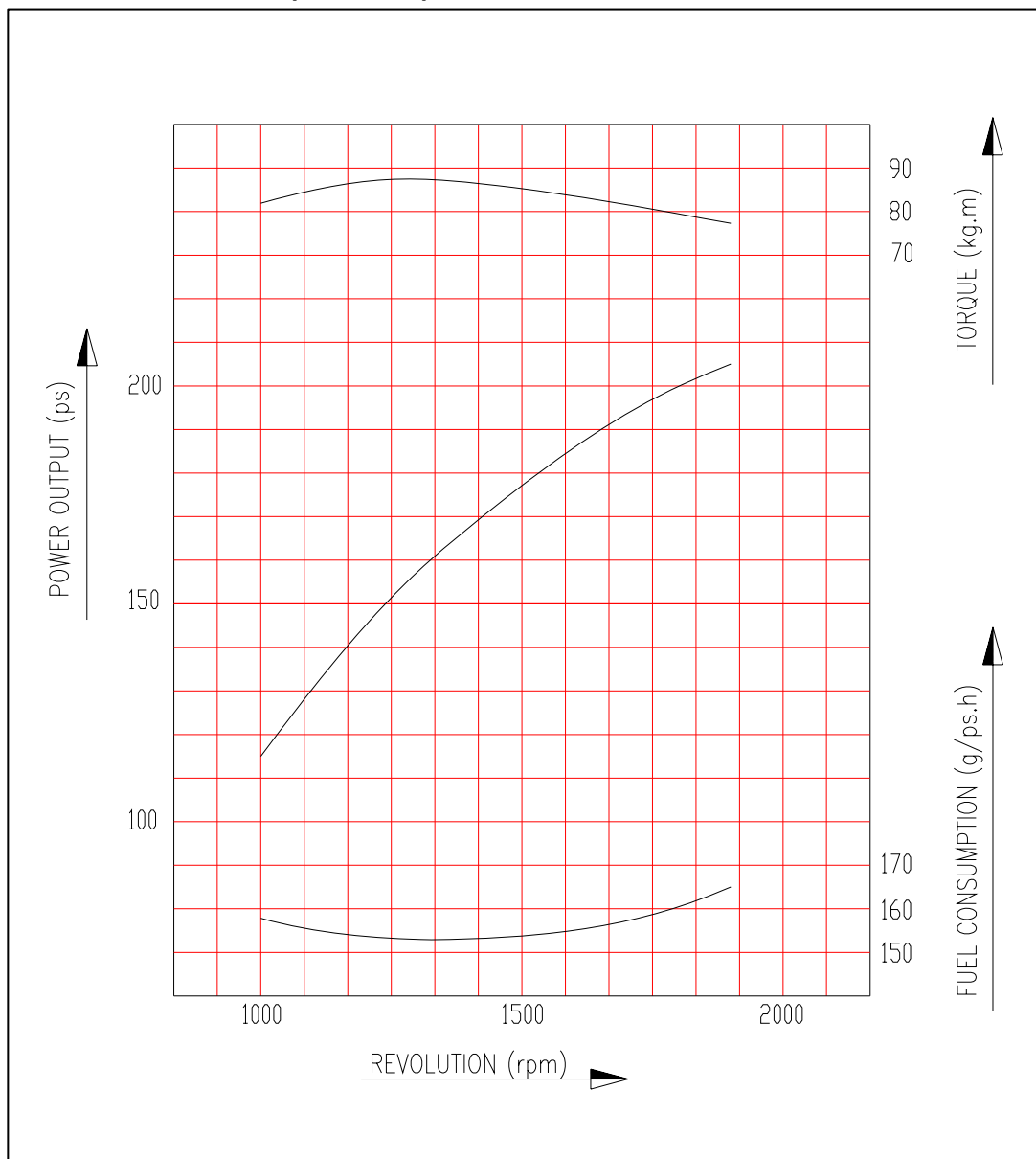

Performance		ISO 1585(SAE J1349)
Output	(max.)	151 kW (205 PS) / 1,900 rpm
Torque	(max.)	864 N.m (88 kg.m) / 1,300 rpm
Fuel consumption	(rated)	224 g/kW.h (165 g / PS.h)

1.1.4. Engine Assembly

(1) D1146TI

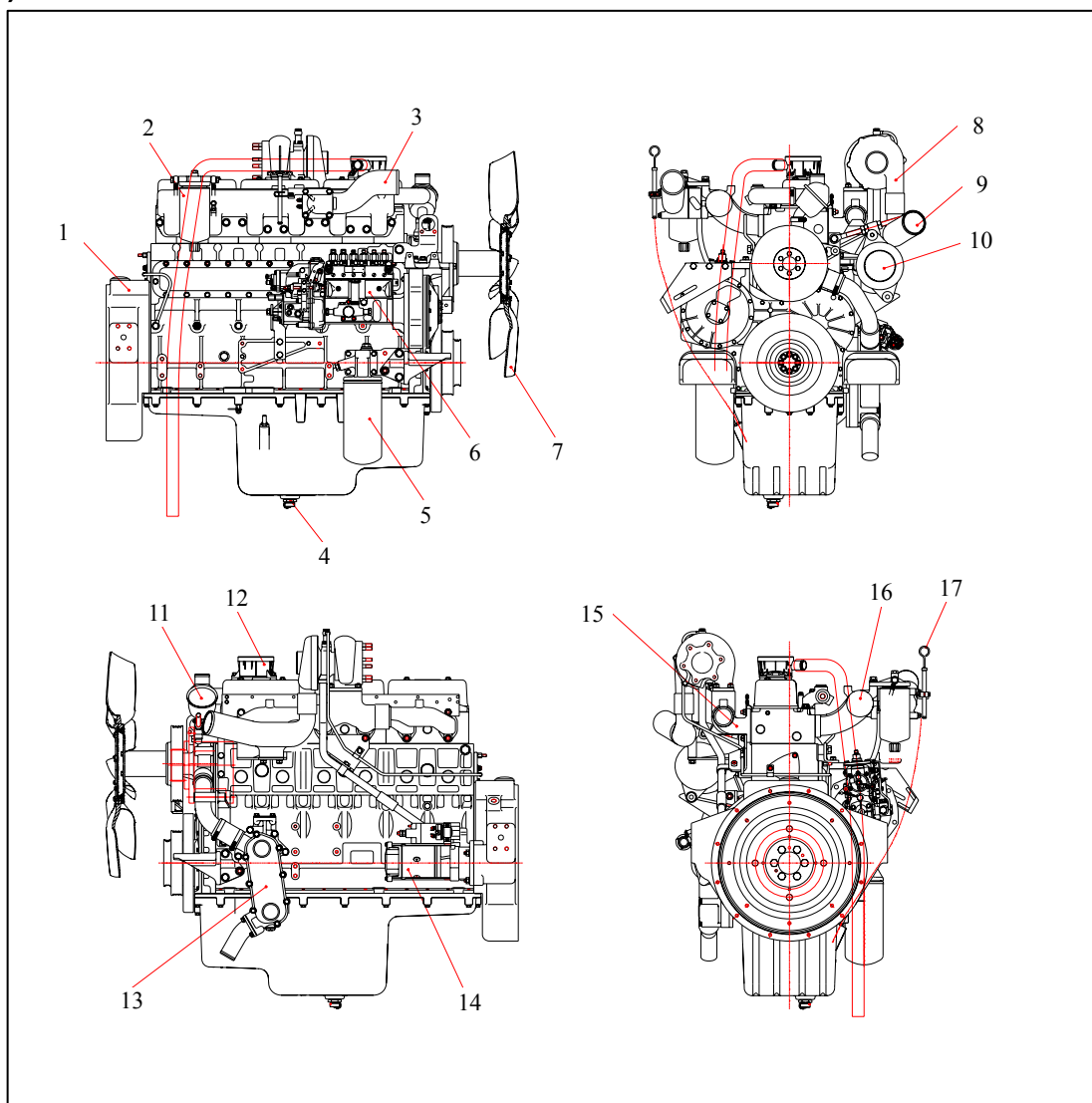

- | | | | |
|---|---------------------|----|------------------|
| 1 | Flywheel housing | 10 | Alternator |
| 2 | Fuel filter | 11 | Thermostat |
| 3 | Air pipe | 12 | Breather |
| 4 | Oil drain plug | 13 | Oil cooler |
| 5 | Oil filter | 14 | Starter |
| 6 | Fuel injection pump | 15 | Exhaust manifold |
| 7 | Cooling fan | 16 | Intake manifold |
| 8 | Turbo charger | 17 | Oil level gauge |
| 9 | Air pipe | | |

(2) DE08TIS

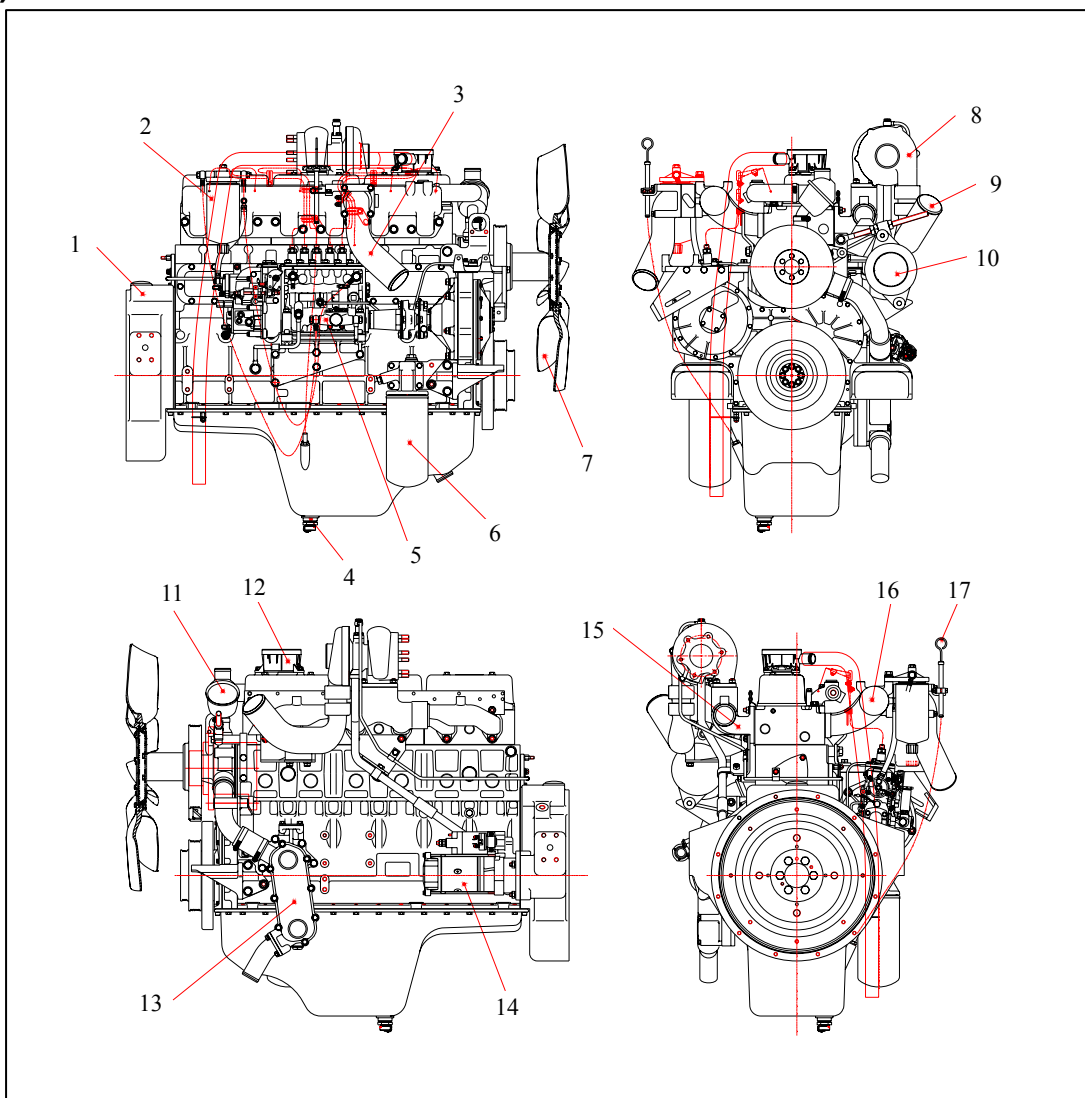

- | | | | |
|---|---------------------|----|------------------|
| 1 | Flywheel housing | 10 | Alternator |
| 2 | Fuel filter | 11 | Thermostat |
| 3 | Air pipe | 12 | Breather |
| 4 | Oil drain plug | 13 | Oil cooler |
| 5 | Oil filter | 14 | Starter |
| 6 | Fuel injection pump | 15 | Exhaust manifold |
| 7 | Cooling fan | 16 | Intake manifold |
| 8 | Turbo charger | 17 | Oil level gauge |
| 9 | Air pipe | | |

1.1.5. Engine model and serial number

- The engine model and serial number is located on the engine as illustrated.
- These numbers are required when requesting warranty and ordering parts. They are also referred to as engine model and serial number because of their location.

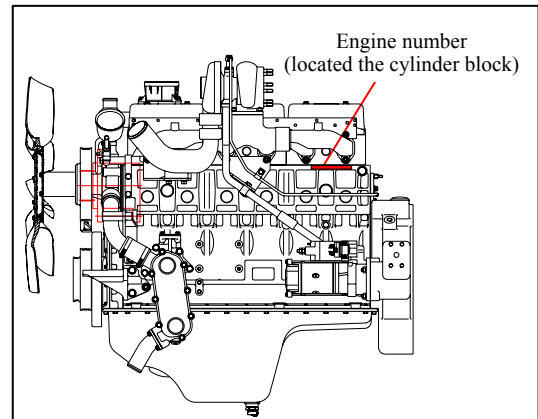

- **Engine serial No. (example 1 : D1146T)**

D1146T 6 00001 EA

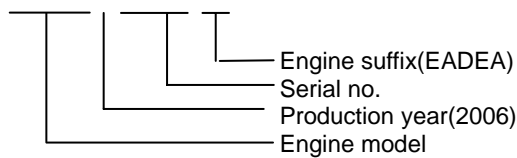

- **Engine serial No. (example 1 : D1146TI)**

D1146TI 6 00001 EA

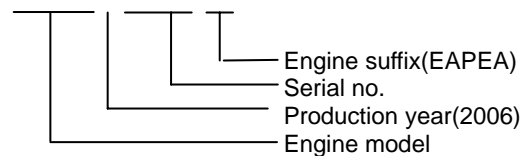

- **Engine serial No. (example 1 : DE08TS)**

DE08TS 7 00001 EA

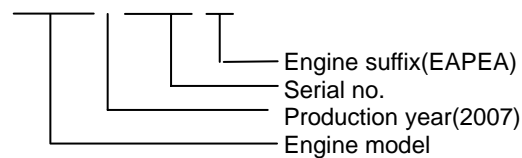

- **Engine serial No. (example 1 : DE08TIS)**

DE08TIS 7 00001 EA

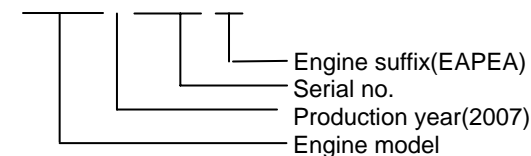

1.1.6. Parts no of injection system

1) Injection pump assembly

Engine model	Part no.	Suffix
D1146T D1146TI	65.11101-7387	EADEA, EAPEA, EAPEB, EAPEC, EAPED, EAPLA
DE08TS	65.11101-7388	ECDF A, ECDFB
DE08TIS	65.11101-7356A	ECPEA, ECPLA

2) Injection nozzle assembly

Engine model	Part no.	Suffix
D1146 D1146T	65.10101-7050A	EACEA, EACEB, EACEC, EACED, EACEE, EACEF, EACEG, EACFA, EACFB, EADEA, EADLA, EADLB, EADLC
D1146TI	65.10101-7080A	EAPEA, EAPEB, EAPEC, EAPED, EAPLA
DE08TS DE08TIS	65.10101-7088	ECDF A, ECDFB, ECPEA, ECPLA

3) Injection pipe assembly

Engine model	Part no.	Suffix
D1146	65.10301-6036A	EACEA, EACEB, EACEC
	65.10301-6040A	EACED, EACEE, EACEF, EACEG, EACFA, EACFB
D1146T D1146TI DE08TS	65.10301-6048C	EADEA, EADLA, EADLB, EADLC, EAPEA, EAPEB, EAPEC, EAPED, EAPLA, ECDF A, ECDFB
DE08TIS	65.10301-6049B 65.10301-6052B	ECPEA, ECPLA

1.1.7. Injection pump calibration data

(1) D1146T engine : EADEA

- 1) Injection pump assembly : 65.11101-7387 (101609-904A DOOWON)
 - Injection pump : KP-PE6AD95B410RS2 (101062-8240)
 - Governor : KP-EP/RSV200/1300AQ39C311 (105411-2150)
 - Plunger and barrel : 131150-2400, 131100-8500
 - Delivery valve : 131110-5120
 - Feed pump : KP-FP/KE-ADS (105210-5610)
 - Prestroke : 4.3±0.05mm
- 2) Nozzle holder assembly : 65.10101-7050A (9135-153 Delphi)
- 3) Nozzle : 65.10102-6026A (9135-143 Delphi)
- 4) Injection pipe : 65.10301-6048C
- 5) Injection order : 1 – 5 – 3 – 6 – 2 – 4

(A) Test condition for injection pump	Nozzle & holder ass'y	105780-8140	Opening pressure : 175kg/cm ²
	Injection pipe(IDxODxL)	-	φ2.0 x φ6.0 – 600 mm
	Test oil	ISO4113	Temperature : 40 ±5°C
(B) Engine standard parts	Nozzle & holder ass'y	65.10102-6026A	Nozzle (5 x φ0.29)
		65.10101-7050A	214+8 kg/cm ²
	Injection pipe(IDxODxL)	65.10301-6048C	φ2.0 x φ6.0 x 650mm

Rack diagram and setting valve at each point : Specification of standard pump(65.11101-7387)

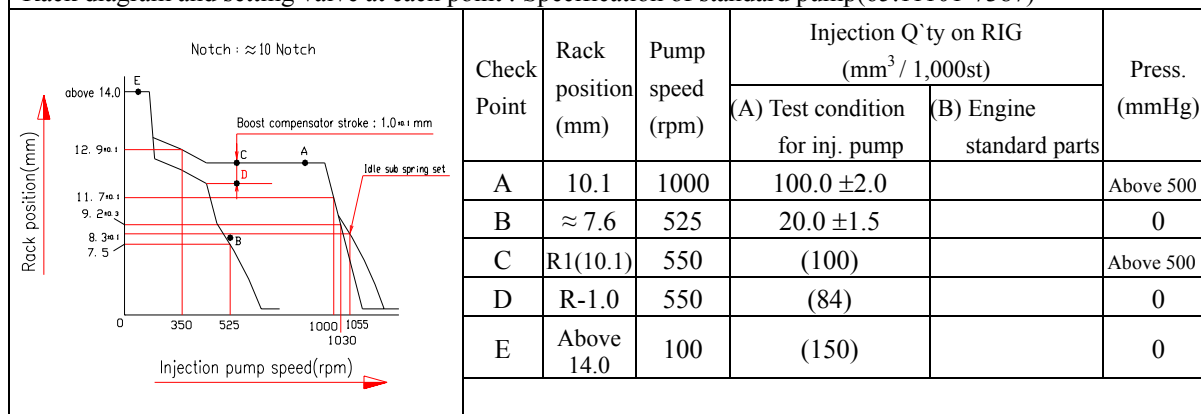

Fuel injection pump

Plunger	φ9.5 Left hand 20 lead	Delivery valve	retraction pressure	70mm ³ /st(φ6x2.5mm)
Max. pump speed (limit plunger bouncing)	1,970 rpm		opening pressure	23.1 kgf/cm ²
Holder delivery valve with damping valve	Orifice diameter φ0.7		Spring	k=1.63 kgf/mm

Governor

Governor weight	740 g	Lever ratio (min. speed / max. speed)	1 : 1.2 / 1 : 1.2
Governor spring	k=7.2 kgf/mm	Idling sub spring	k=2.5 kgf/mm
Idling spring	k=1.9 kgf/mm	Start spring	k=0.01 kgf/mm
Boost compensator spring	k=0.7 kgf/mm	-	-

Feed pump

Max. operating pressure	3.4 kgf/cm ²	Piston spring	k=0.735 kgf/mm
-------------------------	-------------------------	---------------	----------------

f) Rack curve of standard injection pump (65.11101-7387)

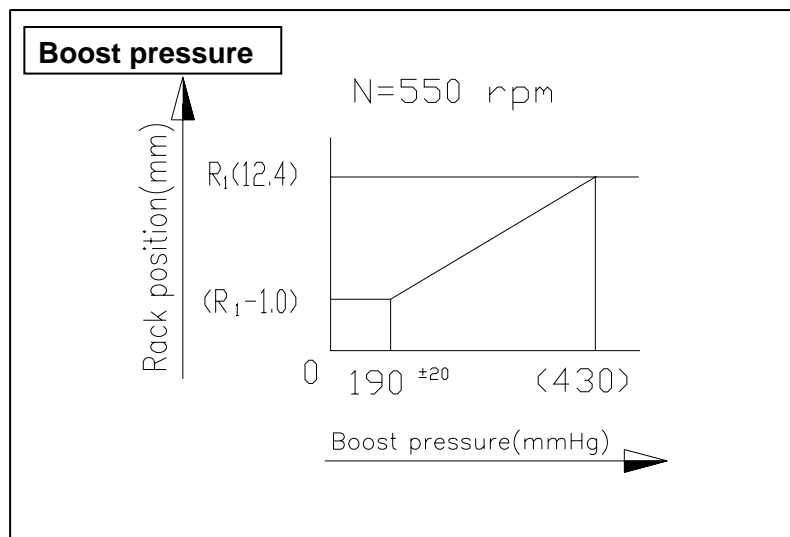
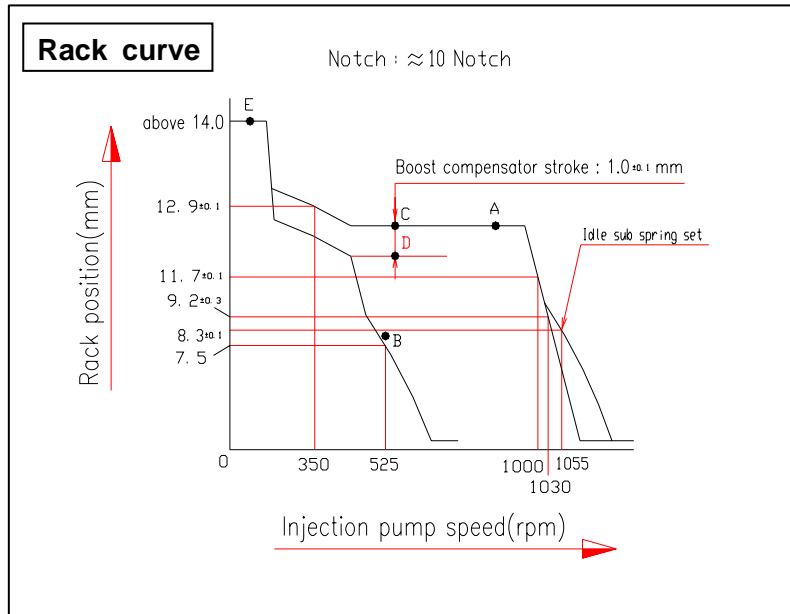

D1146T/D1146TI/DE08TS/DE08TIS
Engine specification & injection pump data for excavator

(2) D1146TI engine : EAPEA, EAPEB, EAPEC, EAPED, EAPLA

- 1) Injection pump assembly : 65.11101-7387 (101609-904A DOOWON)
 - Injection pump : KP-PE6AD95B410RS2 (101062-8240)
 - Governor : KP-EP/RSV200/1300AQ39C311 (105411-2150)
 - Plunger and barrel : 131150-2400,131100-8500
 - Delivery valve : 131110-5120
 - Feed pump : KP-FP/KE-ADS (105210-5610)
 - Prestroke : 4.3±0.05mm
- 2) Nozzle holder assembly : 65.10101-7080A (9135-277 Delphi)
- 3) Nozzle : 65.10102-6040A (9135-276 Delphi)
- 4) Injection pipe : 65.10301-6048C
- 5) Injection order : 1 – 5 – 3 – 6 – 2 – 4

(A) Test condition for injection pump	Nozzle & holder ass'y	105780-8140	Opening pressure : 175kg/cm ²
	Injection pipe(IDxODxL)	-	φ2.0 x φ6.0 – 600 mm
	Test oil	ISO4113	Temperature : 40 ±5°C
(B) Engine standard parts	Nozzle & holder ass'y	65.10102-6040A	Nozzle (5 x φ0.30)
		65.10101-7080A	214+8 kg/cm ²
	Injection pipe(IDxODxL)	65.10301-6048C	φ2.0 x φ6.0 x 650mm

Rack diagram and setting valve at each point : Specification of standard pump(65.11101-7387)

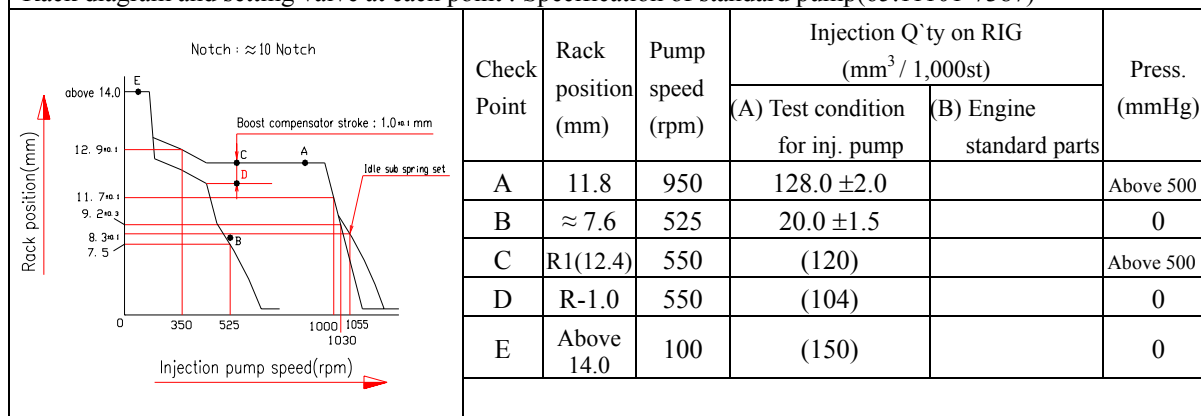

Fuel injection pump

Plunger	φ9.5 Left hand 20 lead	Delivery valve	retraction pressure	70mm ³ /st(φ6x2.5mm)
Max. pump speed (limit plunger bouncing)	1,970 rpm		opening pressure	23.1 kgf/cm ²
Holder delivery valve with damping valve	Orifice diameter φ0.7		Spring	k=1.63 kgf/mm

Governor

Governor weight	740 g	Lever ratio (min. speed / max. speed)	1 : 1.2 / 1 : 1.2
Governor spring	k=7.2 kgf/mm	Idling sub spring	k=2.5 kgf/mm
Idling spring	k=1.9 kgf/mm	Start spring	k=0.01 kgf/mm
Boost compensator spring	k=0.7 kgf/mm	-	-

Feed pump

Max. operating pressure	3.4 kgf/cm ²	Piston spring	k=0.735 kgf/mm
-------------------------	-------------------------	---------------	----------------

D1146T/D1146TI/DE08TS/DE08TIS
Engine specification & injection pump data for excavator

6) Rack diagram and setting valve at each point

a) D1146TI : EAPEA

Check Point	Rack position (mm)	Pump speed (rpm)	Injection Q`ty on RIG (mm ³ / 1,000st)	Pressure (mmHg)
A	12.4	950	128.0 ±2.0	Above 500
B	≈ 7.6	525	20.0 ±1.5	0
C	R1(12.4)	550	(120)	Above 500
D	R-1.0	550	(104)	0
E	Above 14.0	100	(150)	0

b) D1146TI : EAPEB

Check Point	Rack position (mm)	Pump speed (rpm)	Injection Q`ty on RIG (mm ³ / 1,000st)	Pressure (mmHg)
A	12.4	950	128.0 ±2.0	Above 500
B	≈ 7.6	525	20.0 ±1.5	0
C	R1(12.4)	550	(120)	Above 500
D	R-1.0	550	(104)	0
E	Above 14.0	100	(150)	0

c) D1146TI : EAPEC

Check Point	Rack position (mm)	Pump speed (rpm)	Injection Q`ty on RIG (mm ³ / 1,000st)	Pressure (mmHg)
A	12.4	950	124.0 ±2.0	Above 500
B	≈ 7.6	525	20.0 ±1.5	0
C	R1(12.4)	550	(120)	Above 500
D	R-1.0	550	(104)	0
E	Above 14.0	100	(150)	0

d) D1146TI : EAPED

Check Point	Rack position (mm)	Pump speed (rpm)	Injection Q`ty on RIG (mm ³ / 1,000st)	Pressure (mmHg)
A	12.4	950	124.0 ±2.0	Above 500
B	≈ 7.6	525	20.0 ±1.5	0
C	R1(12.4)	550	(120)	Above 500
D	R-1.0	550	(104)	0
E	Above 14.0	100	(150)	0

e) D1146TI : EAPLA

Check Point	Rack position (mm)	Pump speed (rpm)	Injection Q`ty on RIG (mm ³ / 1,000st)	Pressure (mmHg)
A	12.4	950	126.0 ±2.0	Above 500
B	≈ 7.6	525	20.0 ±1.5	0
C	R1(12.4)	550	(120)	Above 500
D	R-1.0	550	(104)	0
E	Above 14.0	100	(150)	0

f) Rack curve of standard injection pump (65.11101-7387)

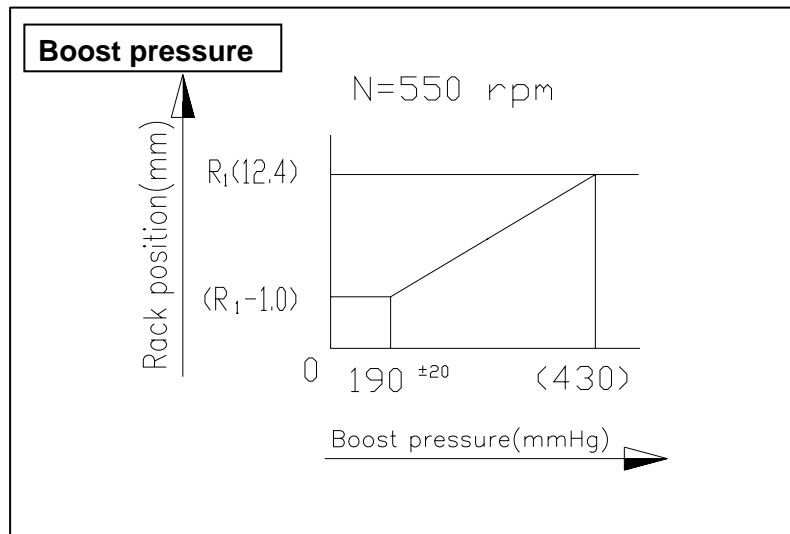
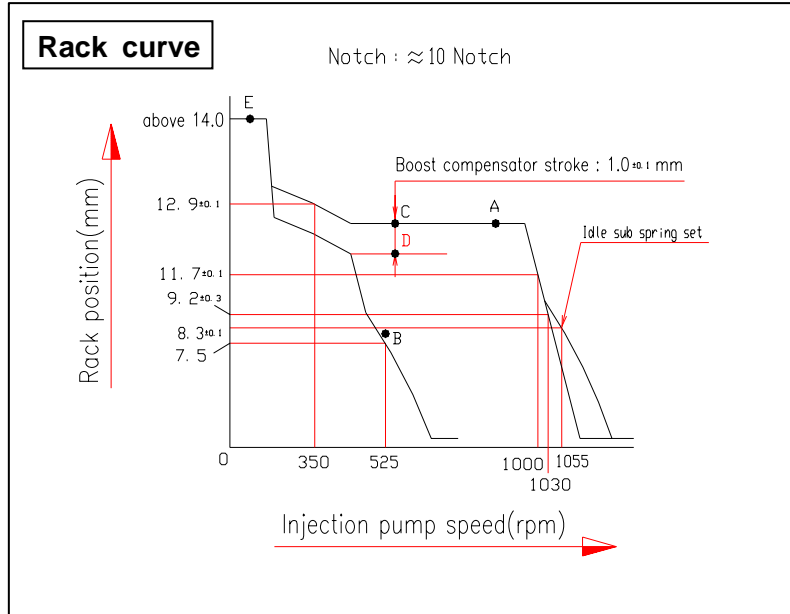

D1146T/D1146TI/DE08TS/DE08TIS
Engine specification & injection pump data for excavator

(3) DE08TS engine : ECDFA, ECDFB

- 1) Injection pump assembly : 65.11101-7388 (101609-904F DOOWON)
 - Injection pump : KP-PES6AD95B410RS2 (101062-8240)
 - Governor : KP-EP/RSV200-1300AQ39C311 (105411-215A)
 - Plunger and barrel : 131150-2400,131100-8500
 - Delivery valve : 131110-5120
 - Feed pump : KP-FP/KE-ADS (105210-5610)
 - Prestroke : 4.3±0.05mm
- 2) Nozzle holder assembly : 65.10101-7088 (Y 430 K02 049 Bosch)
- 3) Nozzle : 65.10102-6058 (0 433 171 736 Bosch)
- 4) Injection pipe : 65.10301-6048C
- 5) Injection order : 1 – 5 – 3 – 6 – 2 – 4

(A) Test condition for injection pump	Nozzle & holder ass'y	105780-8140	Opening pressure : 175kg/cm ²
	Injection pipe(IDxODxL)	-	φ2.0 x φ6.0 – 600 mm
	Test oil	ISO4113	Temperature : 40 ±5°C
(B) Engine standard parts	Nozzle & holder ass'y	65.10102-6058	Nozzle (8 x φ0.218)
		65.10101-7088	180/280 kg/cm ²
	Injection pipe(IDxODxL)	65.10301-6048C	φ2.0 x φ6.0 x 650mm

Rack diagram and setting valve at each point : Specification of standard pump(65.11101-7388)

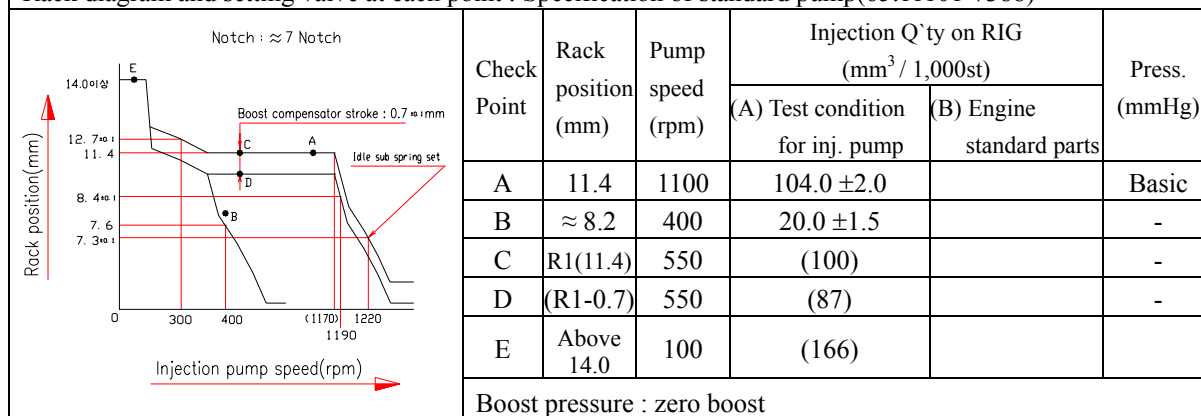

Fuel injection pump

Plunger	φ9.5 Left hand 20 lead	Delivery valve	retraction pressure	70mm ³ /st(φ6x2.5mm)
Max. pump speed (limit plunger bouncing)	1,970 rpm		opening pressure	23.1 kgf/cm ²
Holder delivery valve with damping valve	Orifice diameter φ0.7		Spring	k=1.63 kgf/mm

Governor

Governor weight	740 g	Lever ratio (min. speed / max. speed)	1 : 1.2 / 1 : 1.2
Governor spring	k=7.2 kgf/mm	Idling sub spring	k=2.5 kgf/mm
Idling spring	k=1.9 kgf/mm	Start spring	k=0.01 kgf/mm
Boost compensator spring	k=0.51 kgf/mm	-	-

Feed pump

Max. operating pressure	3.4 kgf/cm ²	Piston spring	k=0.735 kgf/mm
-------------------------	-------------------------	---------------	----------------

6) Rack diagram and setting valve at each point

a) DE08TS : ECDFA

Check Point	Rack position (mm)	Pump speed (rpm)	Injection Q`ty on RIG (mm ³ / 1,000st)	Pressure (mmHg)
A	11.4	1100	91.0 ±2.0	Above 250
B	≈ 8.2	400	20.0 ±1.5	0
C	R1(11.4)	550	(90)	Above 250
D	(R1-0.7)	550	(77)	0
E	Above 14.0	100	(166)	0

b) DE08TS : ECDFB

Check Point	Rack position (mm)	Pump speed (rpm)	Injection Q`ty on RIG (mm ³ / 1,000st)	Pressure (mmHg)
A	11.4	1100	104.0 ±2.0	Above 250
B	≈ 8.2	400	20.0 ±1.5	0
C	R1(11.4)	550	(100)	Above 250
D	(R1-0.7)	550	(87)	0
E	Above 14.0	100	(166)	0

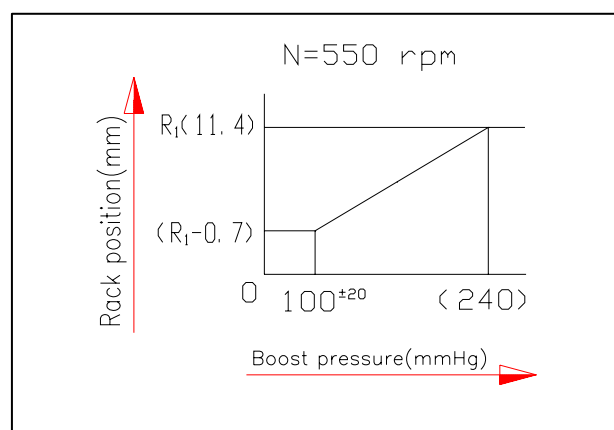
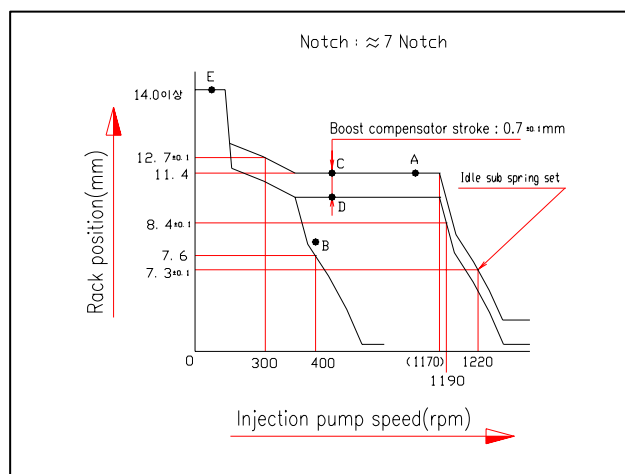

D1146T/D1146TI/DE08TS/DE08TIS
Engine specification & injection pump data for excavator

(4) DE08TIS engine : ECPEA, ECPLA

- 1) Injection pump assembly : 65.11101-7356A (106675-466B DOOWON)
 - Injection pump : KP-PE6P120/721RS3S (106067-180B)
 - Governor : KP-EP/RFD200-1400PF57DZR (105407-620B)
 - Plunger and barrel : 134151-2300,134100-3000
 - Delivery valve : 134110-1420
 - Feed pump : KP-FP/K-PS (105207-1540)
 - Prestroke : 3.9±0.05mm
 - Coupling : 105663-074B
- 2) Nozzle holder assembly : 65.10101-7088 (Y 430 K02 049 Bosch)
- 3) Nozzle : 65.10102-6058 (0 433 171 736 Bosch)
- 4) Injection pipe : 65.10301-6049B
65.10301-6052B
- 5) Injection order : 1 – 5 – 3 – 6 – 2 – 4

(A) Test condition for injection pump	Nozzle & holder ass'y	105780-8140	Opening pressure : 175kg/cm ²
	Injection pipe(IDxODxL)	-	φ3.0 x φ8.0 – 600 mm
	Test oil	ISO4113	Temperature : 40 ±5°C
(B) Engine standard parts	Nozzle & holder ass'y	65.10102-6058	Nozzle (8 x φ0.218)
		65.10101-7088	180/280 kg/cm ²
	Injection pipe(IDxODxL)	65.10301-6049B 65.10301-6052B	φ2.2 x φ6.35 x 650mm

Rack diagram and setting valve at each point : Specification of standard pump(65.11101-7356A)

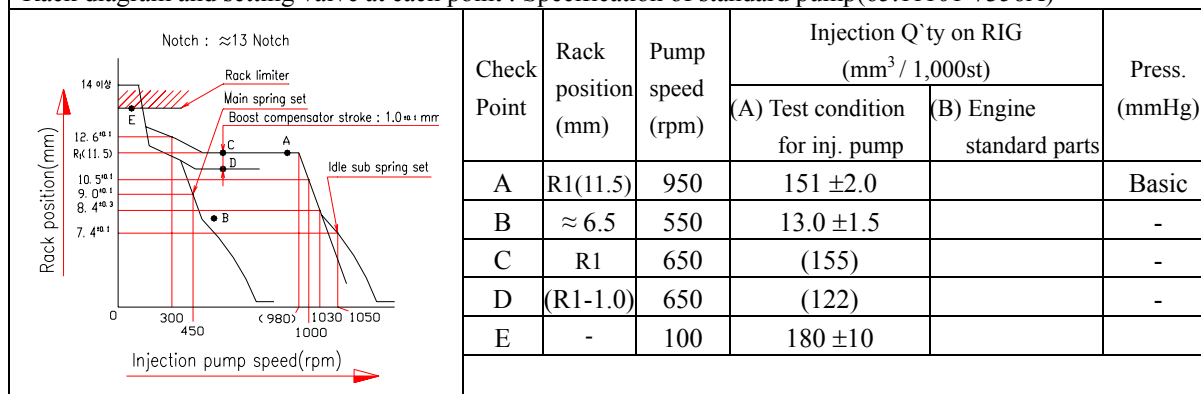

Fuel injection pump

Plunger	φ12 Right hand 30 lead	Delivery valve	retraction pressure	100mm ³ /st(φ8x2.0mm) t = 0.09mm
Max. pump speed (limit plunger bouncing)	1,600 rpm		opening pressure	19.6 kgf/cm ²
Holder delivery valve with damping valve	Orifice diameter φ0.7		Spring	k=0.87 kgf/mm
Governor				
Governor weight	740 g	Lever ratio (min. speed / max. speed)		1 : 1.2 / 1 : 1.2
Governor spring	k=7.2 kgf/mm	Idling sub spring		k=1.2 kgf/mm
Idling spring	k=1.9 kgf/mm	Start spring		k=0.01 kgf/mm
Boost compensator spring	k=0.1 kgf/mm	-		-
Feed pump				
Max. operating pressure	3.0 kgf/cm ²	Piston spring		k=0.735 kgf/mm

6) Rack diagram and setting valve at each point

a) DE08TIS : ECPEA

Check Point	Rack position (mm)	Pump speed (rpm)	Injection Q`ty on RIG (mm ³ / 1,000st)	Pressure (mmHg)
A	R1(11.5)	950	151 ±2.0	Above 300
B	≈ 6.5	550	13.0 ±1.5	0
C	R1	650	(155)	Above 300
D	(R1-1.0)	650	(122)	0
E	-	100	180 ±10	0

b) DE08TIS : ECPLA

Check Point	Rack position (mm)	Pump speed (rpm)	Injection Q`ty on RIG (mm ³ / 1,000st)	Pressure (mmHg)
A	R1(11.5)	950	151 ±2.0	Above 300
B	≈ 6.5	550	13.0 ±1.5	0
C	R1	650	(155)	Above 300
D	(R1-1.0)	650	(122)	0
E	-	100	180 ±10	0

