

STC300S-Y2

STC300S-Y2 TRUCK CRANE 30 TONS LIFTING CAPACITY

Quality Changes the World

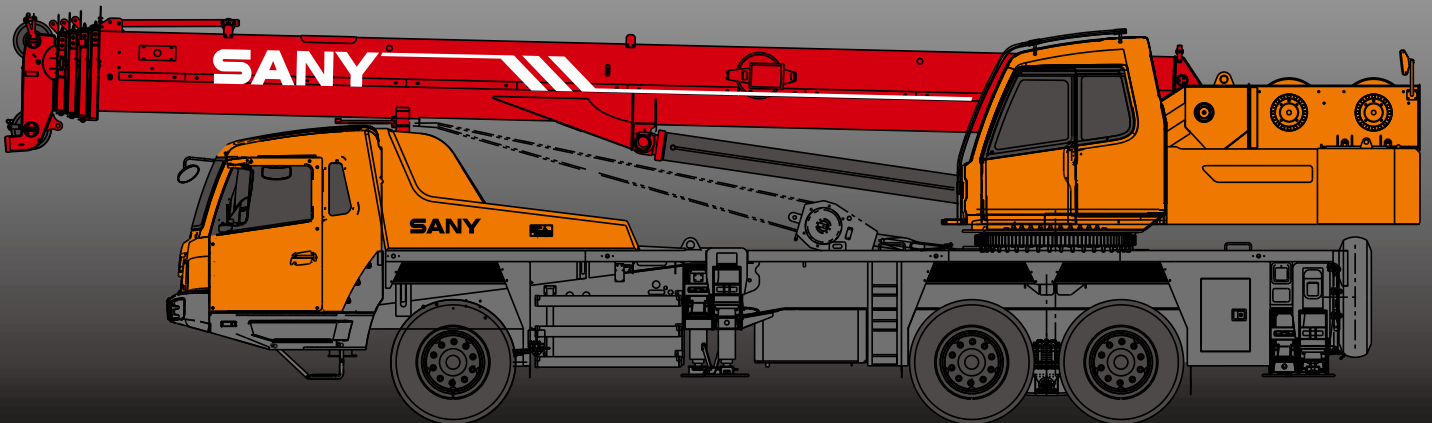

SANY

■ SANY Automobile Hoisting Machinery is one of the core business unit of Sany Heavy Industry, mainly engaged in the research and development of high end, mid to large tonnage crane series, including mobile crane, crawler crane, tower crane and loader crane. It has two industrial parks in Ningxiang and Huzhou, since entering the market, the products of Sany Automobile Hoisting Machinery have received worldwide recognition with advanced technology, lean manufacturing, high reliability and excellent service.



SANY TRUCK CRANE

CONTENT

- 04 Icon
- 05 Selling Points
- 06 Introduction
- 09 Dimension
- 10 Technical Parameter
- 11 Operation Condition
- 12 Load Chart
- 14 Wheel Crane Family Map

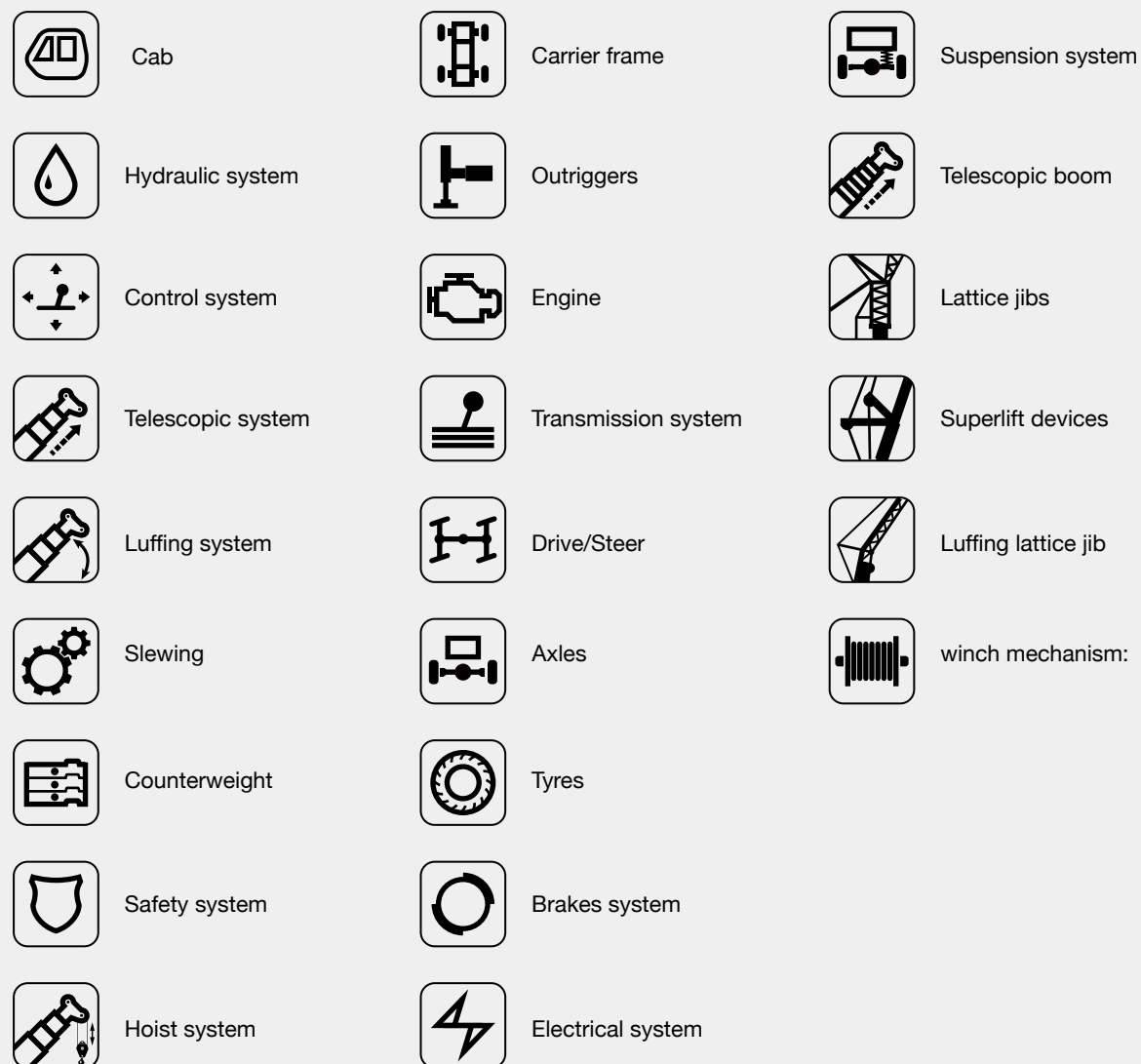

Excellent and stable chassis performance / chassis system

Double-axle drive is used, providing good trafficability and comfortableness under complex road condition with reliable traveling performance.

Engine has the multimode power output function, which reduces power consumption.

The use of tipping over early-warning technology provides high stability and safety of the overall operation.



Highly efficient, stable, energy-saving and adjustable hydraulic system

Hydraulic system load feedback featuring long service life, high efficiency and low energy consumption is applied to enhance lifting capacity and micro-mobility. Unique steering buffer design is applied to ensure stable braking operation.



Ultra long and super strong boom system







10.6m basic boom, 40.5m full-extended boom and Max. lifting height of 49m including jib take the leads in industry in the same tonnage. Rated lifting capacity is 30T, ensuring super strong lifting capacity. Jib mounting angles are 0°, 15°, and 30° which ensure fast and convenient change-over between different operating conditions so as to improve working efficiency of the machine.





Safe, stable, advanced and intelligent electric control system

The adoption of CAN-bus full-digital network control technology ensures stable control signal, simple harness, and high reliability. Timely feedback of data information can achieve the monitoring of the overall working status in real time. The load moment limiter equipping with the comprehensive intelligent protection system is used with accuracy within 3% to provide a comprehensive logic and interlock control, thus ensuring more safe and reliable operation.





Superstructure

-  **Cab**
- It is made of safety glass and anti-corrosion steel plate with ergonomic design such as full-coverage soften interior, large interior space, panoramic sunroof and adjustable seats etc., and humanized design providing more comfortable and relaxing operation experience. The display of load moment limiter integrates main console and operation display system, which clearly show the data of all operating superstructure conditions for lifting operation.
-  **Hydraulic system**
- High-quality key hydraulic components such as main oil pump, main valve, winch motor, rotary motor and balancing parts etc. are adopted to achieve stable and reliable operation of the hydraulic system. Superior operation performance is guaranteed by accurate parameter matching.
 - Main valve has flow compensation, load feedback control function, enabling stable and convenient control of single action and combined action under different operation conditions.
 - Winch adopts the variable motor to ensure high operation efficiency. Max. single line speeds of main and auxiliary winches is up to 130r/min which ensures the lifting efficiency take the lead in industry.
 - The use of new hydraulic control variable slewing system ensures more stable starting and control of the slewing operation and excellent micro-mobility.
-  **Control system**
- CAN-bus instrument: CAN-bus instrument with a combined intelligent control electrical system is used for easy reading of the traveling parameters at any time. The engine fault warning function is applied to ensure convenient and fast troubleshooting.
 - Load moment limiter: The adoption of high intelligent load moment limiter system can
 - comprehensively protect lifting operation, ensuring accurate, stable and comfort operation.
-  **Luffing system**
- Dynamic luffing provides more stable luffing operation at low energy loss
 - Luffing angle: $-2^{\circ} \sim 80^{\circ}$.
-  **Telescopic system**
- Five-section boom is applied with basic boom length of 10.6m, fully extended boom length of 40.5m, jib length of 8 m and lifting height of fully extended boom length of 41m respectively. Max. lifting height is 49m including jib. It is made of high-strength steel with U-shaped cross section and with telescopic operation controlled independent by dual-cylinder rope.
-  **Slewing system**
- 360° rotation can be achieved with Max. slewing speed of 2.5r/min, providing stable and reliable operation of the system.







Superstructure

-  **Hoisting system**
- The winch adopts the high-pressure automatic variable plunger motor, enabling automatic switch-over between low load high speed mode and high load low speed mode, and ensuring highly efficient operation and stable lifting and lowering of the load.
 - One main hook: 320Kg, one auxiliary hook: 90Kg. Wire rope of main winch: left-handed wire rope 16-35W \times 7-1960USS, with length of 200m. Wire rope of auxiliary winch: left-handed wire rope 16-35W \times 7-1960USS, with length of 105m.
-  **Safety system**
- Load moment limiter: Load moment limiter calculation system based on lifting load mechanical model is established using an analytical mechanics method, with rated lifting accuracy up to $\pm 3\%$ through on-line non-load calibration, providing full protection to lifting operation. In case of overload operation, system will automatically issue an alarm to provide safety protection for manipulation.
 - Hydraulic system is configured with the balance valve, overflow valve and two-way hydraulic lock etc. components, thus achieving the stable and reliable operation of the hydraulic system.
 - Main winch is equipped with over roll-out limiter to prevent over rolling-out of wire rope.
 - Boom and jib ends are equipped with height limiters respectively to prevent over-hoisting of wire rope.
 - Boom head is equipped with linear transducer, angular transducer and press sensor to indicate the working condition of whole crane in real-time, giving an alarm and cutting off the dangerous action automatically.
-  **Counterweight**
- Counterweight is 5500kg, no flexible counterweight.

Chassis

-  **Driving cab**
- Cab is made of new steel material and sealed rubber structure self-developed by SANY, featuring excellent shock absorption and tightness, which is configured with swing-out doors at both sides, pneumatically suspended driver's seat and passenger seat, adjustable steering wheel, large rearview mirror, comfort driver chair with a headrest, anti-fog fan, air conditioner, stereo radio, and complete control instruments and meters, providing more comfortable, safe, and humanized operation experience.
-  **Carrier frame**
- Designed and manufactured by SANY, anti-torsion box structure is welded by fine-grain high-strength steel plate to provide strong load bearing capacity.
-  **Axles**
- Axles 2 and 3 are drive axles and axle 1 is steering axle, axle and wheel differentials are installed in axles 2 and 3. The use of welding process for axle housing provides stronger load bearing capacity.
-  **Engine**
- Type: Inline six-cylinder, water cooled, supercharged and inter-cooling diesel engine
 - Rated power: 213kW/2100(r/min)
 - Environment-protection: Emission complies with EuroIII standard
 - Capacity of fuel tank: 300L.

Chassis

 Transmission system	<ul style="list-style-type: none"> ■ Gearbox: Manual/automatic gearbox is adopted, with 9-gear and large speed ratio range applied, which meets the requirements of low gradeability speed and high traveling speed. ■ Transmission shaft: With optimized arrangement of the transmission shaft, the transmission is stable and reliable. ■ For most optimized transmission, face-tooth coupling transmission shaft is used with large transmission torque.
 Brakes system	<ul style="list-style-type: none"> ■ Air serve brakes are used for all wheels with dual-circuit brake system applied. Engine is equipped with an exhaust brake.
 Suspension system	<ul style="list-style-type: none"> ■ All axles adopt the plate spring suspension systems with plate spring passed 100,000 fatigue tests and with optimization of performance parameters of the front and rear plate springs applied to ensure strength and also to provide comfort ridding.
 Steering system	<ul style="list-style-type: none"> ■ Hydraulic power mechanical steering system is applied for axle 1 with unloading valve installed in the steering gear.
 Outriggers	<ul style="list-style-type: none"> ■ Four-point supporting of the H-shaped outriggers ensures easy operation and strong stability. They are made of fine-grain high-strength steel sheet. With full hydraulic horizontal telescoping for flexible outriggers.
 Tyres	<ul style="list-style-type: none"> ■ 11 (number of tyres) - type: 11.00-20-18PR; bias tires are used, featuring with large bearing capacity and durable use.
 Electrical system	<ul style="list-style-type: none"> ■ With 2*12V maintenance-free batteries, the crane power can be cut off manually via a mechanical master power switch.

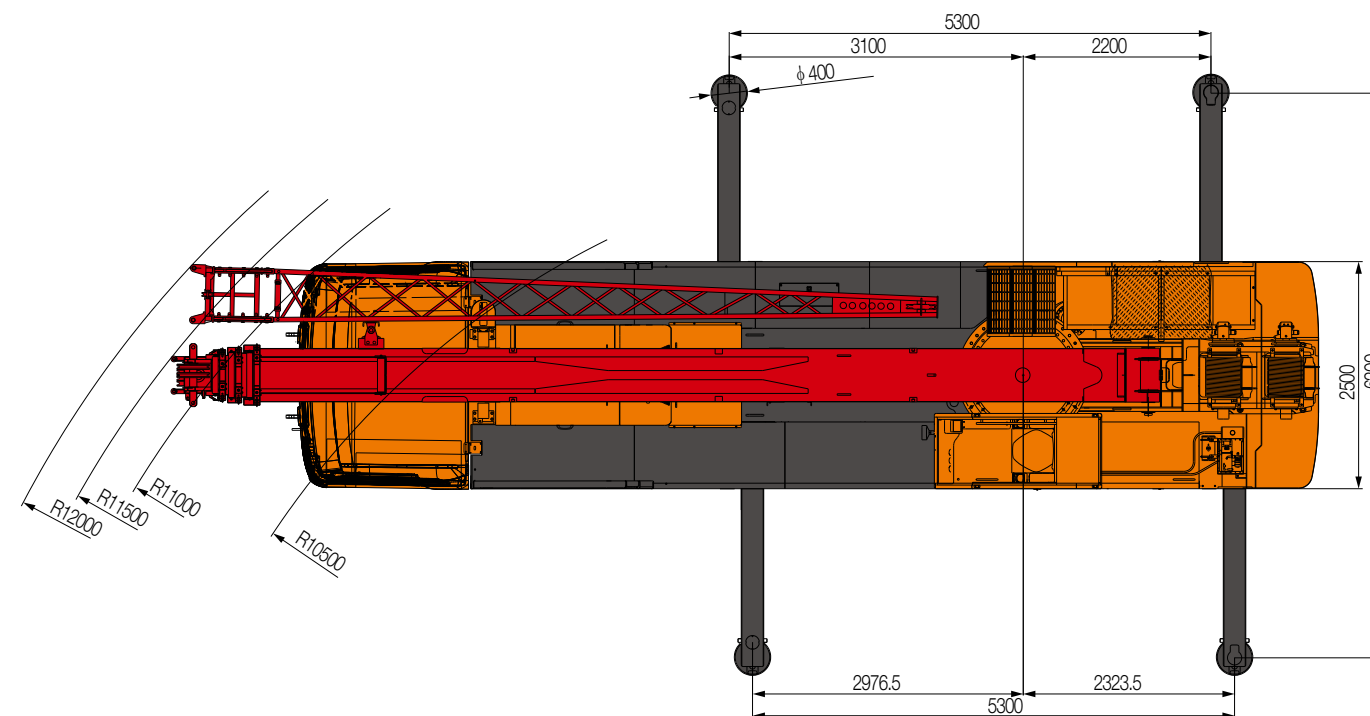
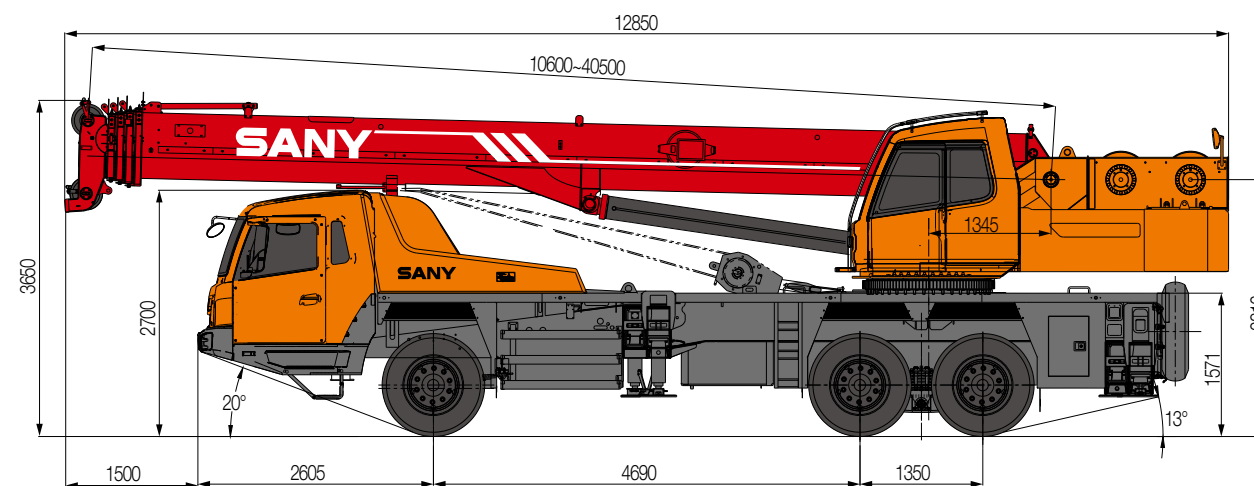

STC300S-Y2 TRUCK CRANE
TECHNICAL PARAMETER

Type	Item	Parameter	
Capacity	Max. lifting capacity	30 t	
Dimensions	Overall length	12850mm	
	Overall width	2500mm	
	Overall height	3650mm	
	Axle distance	4690mm/1350mm	
Weight	Overall weight	33000kg	
	Axle load	Front axle load	7100kg
		Rear axle load	25900kg
Engine	Rated power	213kW/2100(r/min)	
	Rated torque	1050N.m/1200~1400rpm	
Traveling	Max.traveling speed	89Km/h	
	Turning radius	Min.turning radius	10.5m
	Min.ground clearance	220mm	
	Approach angle	20°	
	Departure angle	13°	
	Max.gradeability	40%	
	Fuel consumption per 100km	34.5L	
Main performance parameters	Min.rated range	3m	
	Tail slewing radius of swingtable	3.47m	
	Boom section	5	
	Boom shape	U-shaped	
	Max.lifting moment	Base boom	1029kN.m
		Full-extend boom	573kN.m
		Full-extend boom+jib	387kN.m
	Boom length	Base boom	10.6m
		Full-extend boom	40.5m
		Full-extend boom+jib	48.5m
Outrigger span (Longitudinal×Transversal)	5.3m×6.2m		
Working speed	Max.single rope lifting speed of main winch (no load)	130m/min	
	Max.single rope lifting speed of auxiliary winch (no load)	130m/min	
	Full extension/retraction time of boom	100s/100s	
	Full lifting/descending time of boom	45s/55s	
	Slewing speed	(0~2.5) r/min	
Air conditioner	Superstructure	Cold and Heating	
	Chassis	Cold and Heating	

STC300S-Y2 Working Ranges

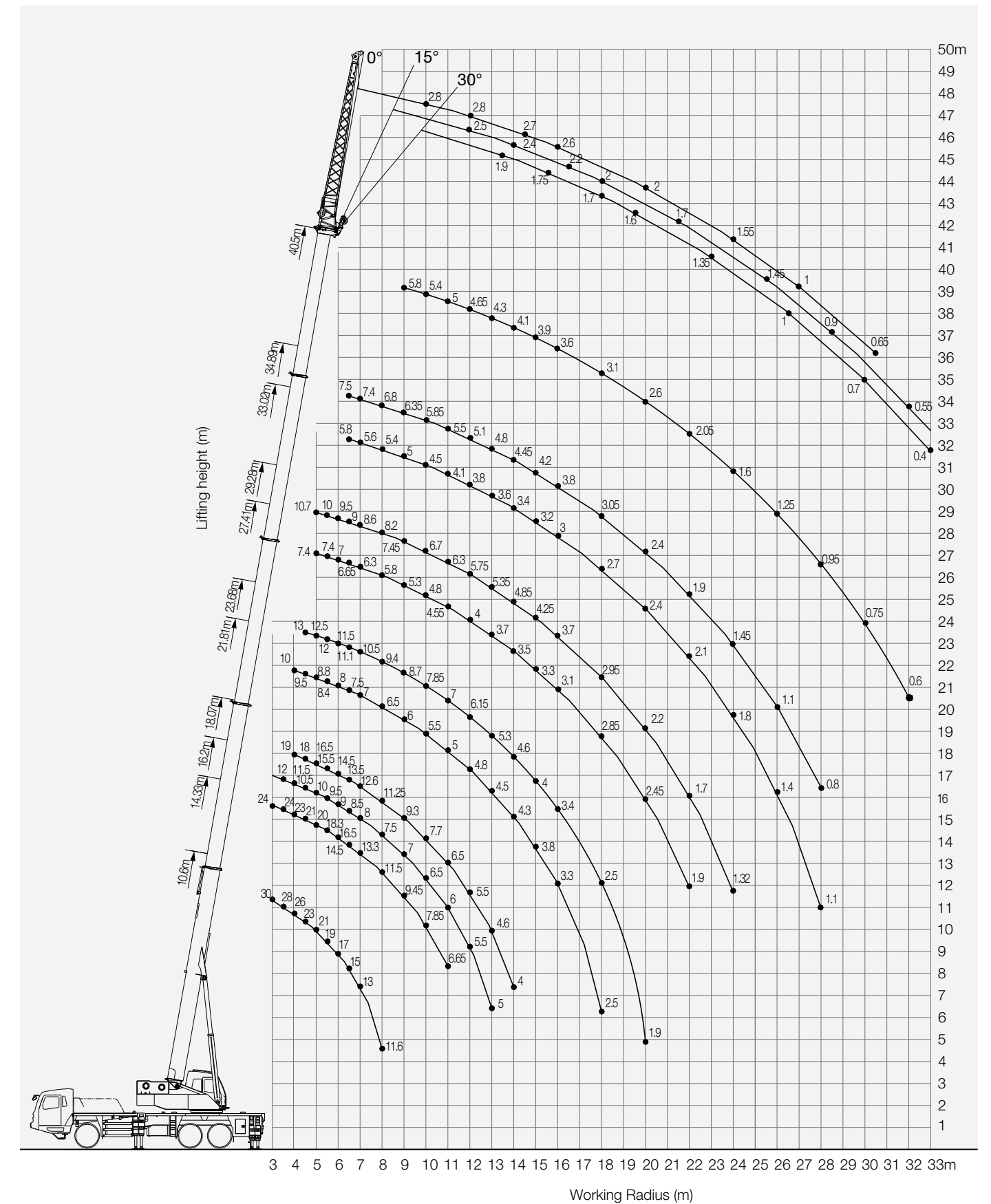

STC300S-Y2 TRUCK CRANE
LOAD CHART

Unit:Kg

- Prerequisites:**
 ① **Operating condition (fully extended boom +jib) 10.6m-40.5m;**
 ② **Outrigger length: 6.2m;**
 ③ **360° rotation;**
 ④ **Counterweight: 5.5t.**

Working range(m)	Main boom											Working range(m)
	10.6m	14.33m	16.2m	18.07m	21.81m	23.68m	27.41m	29.28m	33.02m	34.89m	40.5m	
3	30000	24000										3
3.5	28000	24000	12000									3.5
4	26000	23000	11500	19000	10000							4
4.5	23000	21000	10500	18000	9500	13000						4.5
5	21000	20000	10000	16500	8800	12500	7400	10700				5
5.5	19000	18300	9500	15500	8400	12000	7400	10000				5.5
6	17000	16500	9000	14500	8000	11500	7000	9500				6
6.5	15000	14500	8500	13500	7500	11100	6650	9000	5800	7500		6.5
7	13000	13300	8000	12600	7000	10500	6300	8600	5600	7400		7
8	11600	11500	7500	11250	6500	9400	5800	8200	5400	6800		8
9		9450	7000	9300	6000	8700	5300	7450	5000	6350	5800	9
10		7850	6500	7700	5500	7850	4800	6700	4500	5850	5400	10
11		6650	6000	6500	5000	7000	4550	6300	4100	5500	5000	11
12			5500	5500	4800	6150	4000	5750	3800	5100	4650	12
13			5000	4600	4500	5300	3700	5350	3600	4800	4300	13
14				4000	4300	4600	3500	4850	3400	4450	4100	14
15					3800	4000	3300	4250	3200	4200	3900	15
16					3300	3400	3100	3700	3000	3800	3600	16
18					2500	2500	2850	2950	2700	3050	3100	18
20						1900	2450	2200	2400	2400	2600	20
22							1900	1700	2100	1900	2050	22
24								1320	1800	1450	1600	24
26									1400	1100	1250	26
28									1100	800	950	28
30											750	30
32											600	32
Number of lines	8	8	6	6	4	4	4	4	4	4	3	Number of lines
Telescoping												
II	0	50%	0	100%	0	100%	0	100%	0	100%	100%	II
III	0	0	25%	0	50%	25%	75%	50%	100%	75%	100%	III
IV	0	0	25%	0	50%	25%	75%	50%	100%	75%	100%	IV
V	0	0	25%	0	50%	25%	75%	50%	100%	75%	100%	V

Unit:Kg

Load chart for jib

Angle of elevation(°)	Boom+jib			Angle of elevation(°)
	40.5m+8m			
	compensation angle 0°	compensation angle 15°	compensation angle 30°	
78	2800	2500	1900	78
75	2800	2400	1750	75
72	2700	2200	1700	72
70	2600	2000	1600	70
65	2000	1700	1350	65
60	1550	1450	1000	60
55	1000	900	700	55
50	650	550	400	50

Notes:

1. Values listed in the table refer to rated lifting capacity measured at flat and solid ground under the lever state of the crane;
2. Value above heavy line shall be determined by strength of the crane and under this line shall be determined by stability of the crane;
3. Working radius listed in the load chart is the actual radius with load;
4. Rated load values determined by stability shall comply with ISO 4305;
5. Rated lifting capacity listed in the table included weights of lifting hooks (320kg of main hook and 90kg of auxiliary hook)and hangers;
6. With the 5th outrigger extended, the value listed in the table shall be applicable for 360°operation;
7. Rated lifting capacity with pulley at boom tip shall not exceed 3500kg. If jib is applied, the rated lifting capacity of the boom shall be deducted by 550kg.
8. If actual boom length and range are between two values specified in the table, larger value will determine the lifting capacity.

STC300S-Y2 TRUCK CRANE
 WHEEL CRANE FAMILY MAP

■ TRUCK CRANE

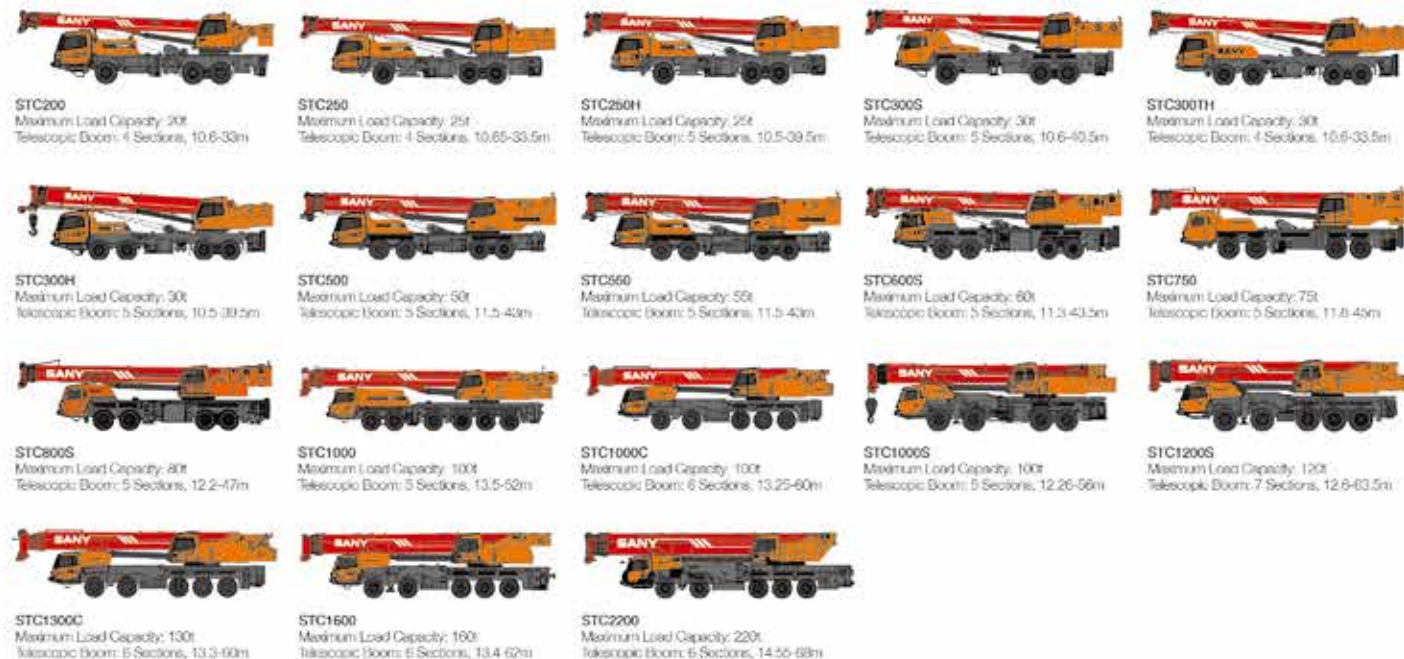

■ ALL TERRAIN CRANE



■ ROUGH-TERRAIN CRANE

