

Operation & Maintenance Manual

LIFT TRUCKS

D35S-2, D40S-2, D45S-2, D50C-2

G35S-2, G40S-2, G45S-2, G50C-2

D40SC-2, D45SC-2, D50SC-2

G40SC-2, G45SC-2, G50SC-2

D35S-2, D40S-2, D45S-2, D50C-2

D40SC-2, D45SC-2, D50SC-2

G35S-2, G40S-2, G45S-2, G50C-2

(TIER II & STAGE II CERTIFIED TRUCK)

 **WARNING**

Do not start, operate or service this machine unless you have read and understood these instructions and received proper training.
Unsafe or improper use of the machine may cause serious injury or death.
Operators and maintenance personnel must read this manual and receive training before operating or maintaining the machine.
This manual should be kept with the machine for reference and periodically reviewed by the machine operator and by all personnel who will come into contact with it.

The following warning is provided pursuant to California Health & Safety Code Sections 25247.5 et, seq,

 **WARNING**

California Proposition 65

Engine Exhaust, some of its constituents, and certain vehicle components contain or emit chemicals known to the State of California to cause cancer and birth defects or other reproductive harm.

Battery posts, terminals and related accessories contain lead and lead compounds, chemicals known to the State of California to cause cancer and birth defects or other reproductive harm.

WASH HANDS AFTER HANDLING.

Table of Contents

Information Section

Foreword.....	2
---------------	---

Safety Section

Important Safety Information.....	4
Safety	5
Warning Signs and Labels.....	5
General Hazard Information.....	10
Operation Information.....	11
Before Starting the Lift Truck.....	11
Maintenance Information.....	14
Operator Restraint System (If Equipped) ..	17
Avoiding Lift Truck Tipovers.....	21
Safety Rules	23
How to Survive in a Tipover (If Operator Restraint System Equipped)	28

General Section

Specifications	30
Noise and Vibration.....	36
Capacity Chart.....	37
Capacity Chart (with Side Shifter).....	39
Serial Number	47
Operator's Warning and Identification Plate	49

Operation Section

Operator's Station and Monitoring Systems.....	51
Seat Switch System (If Equipped).....	56
Lift Truck Controls	57
Refueling.....	60
After Starting the Engine.....	67
Lift Truck Operation	86
Auto Shift Controller ASC – 200 (If Equipped) ..	88
Operating Techniques.....	91
Parking the Lift Truck.....	95
Lift Fork Adjustment.....	96
Storage Information	97
Transportation Hints.....	98
Towing Information	99

Maintenance Section

Inspection, Maintenance and Repair of Lift Truck Forks	100
Tire Inflation Information.....	104
Torque Specifications.....	105
Cooling System Specifications	107
Fuel Specifications	109
Lubricant Specifications.....	111
Lubricant Viscosities and Refill Capacities	114
When Required.....	118
Every 10 Service Hours or Daily.....	125
First 50 – 100 Service Hours or a Week.....	129
First 250 Service Hours or a Month.....	135
Every 250 Service Hours or Monthly.....	136
Every 500 Service Hours or 3 Months.....	144
Every 1000 Service Hours or 6 Months.....	150
Every 1500 Service Hours or 9 Months.....	156
Every 2000 Service Hours or Yearly	159
Every 2500 Service Hours or 15 Months	164
Every 4500 Service Hours or two Years.....	166

Index Section

Index	167
-------------	-----

Foreword

Literature Information

This manual should be stored in the operator's compartment in the literature holder or seat back literature storage area.

This manual contains safety, operation, transportation, lubrication and maintenance information.

Some photographs or illustrations in this publication show details or attachments that can be different from your lift truck. Guards and covers might have been removed for illustrative purposes.

Continuing improvement and advancement of product design might have caused changes to your lift trucks which are not included in this publication.

Read, study and keep this manual with the lift truck.

Whenever a question arises regarding your lift truck, or this publication, please consult your *DOOSAN* dealer for the latest available information.

Safety

The Safety Section lists basic safety precautions. In addition, this section identifies the text and locations of warning signs and labels used on the lift truck. Read and understand the basic precautions listed in the Safety Section before operating or performing lubrication, maintenance and repair on this lift truck.

Operator Restraint System (If Equipped)

This manual contains safety, operation and maintenance information for the *DOOSAN* operator restraint system. Read, study and keep it handy.

WARNING

Your *DOOSAN* truck comes equipped with an operator restraint system. Should it become necessary to replace the seat for any reason, it should only be replaced with another *DOOSAN* operator restraint system.

Photographs or illustrations guide the operator through correct procedures of checking, operation and maintenance of the *DOOSAN* operator restraint system.

SAFE and EFFICIENT OPERATION of a lift truck depends to a great extent on the skill and alertness on the part of the operator. To develop this skill the operator should read and understand the Safe Driving Practices contained in this manual.

Forklift trucks seldom tipover, but in the rare event they do, the operator may be pinned to the ground by the lift truck or the overhead guard. This could result in serious injury or death.

Operator training and safety awareness is an effective way to prevent accidents, but accidents can still happen. The *DOOSAN* operator restraint system can minimize injuries. The *DOOSAN* operator restraint system keeps the operator substantially within the confines of the operator's compartment and the overhead guard.

This manual contains information necessary for Safe Operation. Before operating a lift truck make sure that the necessary instructions are available and understood.

Operation

The Operation Section is a reference for the new operator and a refresher for the experienced one. This section includes a discussion of gauges, switches, lift truck controls, attachment controls, transportation and towing information.

Photographs and illustrations guide the operator through correct procedures of checking, starting, operating and stopping the lift truck.

Operating techniques outlined in this publication are basic. Skill and techniques develop as the operator gains knowledge of the lift truck and its capabilities.

Maintenance

The Maintenance Section is a guide to equipment care. The illustrated, step-by-step instructions are grouped by servicing intervals. Items without specific intervals are listed under "When Required" topics. Items in the "Maintenance Intervals" chart are referenced to detailed instructions that follow.

Maintenance Intervals

Use the service hour meter to determine servicing intervals. Calendar intervals shown (daily, weekly, monthly, etc.) can be used instead of service hour meter intervals if they provide more convenient servicing schedules and approximate the indicated service hour meter reading. Recommended service should always be performed at the interval that occurs first.

Under extremely severe, dusty or wet operating conditions, more frequent lubrication than is specified in the "Maintenance Intervals" chart might be necessary.

Perform service on items at multiples of the original requirement. For example, at "Every 500 Service Hours or 3 Months", also service those items listed under "Every 250 Service Hours or Monthly" and "Every 10 Service Hours or Daily".

Environment Management

Note that *DOOSAN INFRACORE* is ISO 14001 certified which is harmonized with ISO 9001. Periodic ENVIRONMENTAL AUDITS & ENVIRONMENTAL PERFORMANCE EVALUATIONS have been made by internal and external inspection entities. LIFE-CYCLE ANALYSIS has also been made through out the total product life. ENVIRONMENT MANAGEMENT SYSTEM includes DESIGN FOR ENVIRONMENT from the initial stage of the design.

ENVIRONMENT MANAGEMENT SYSTEM considers environmental laws & regulations, reduction or elimination of resource consumption as well as environmental emission or pollution from industrial activities, energy saving, environment-friendly product design (lower noise, vibration, emission, smoke, heavy metal free, ozone depleting substance free, etc.), recycling, material cost reduction, and even environmentally oriented education for the employee.

Important Safety Information

Most accidents involving product operation, maintenance and repair are caused by failure to observe basic safety rules or precautions. An accident can often be avoided by recognizing potentially hazardous situations before an accident occurs. A person must be alert to potential hazards, and use common sense. Persons must also have the necessary training, skills and tools before attempting to perform these functions.

Improper operation, lubrication, maintenance or repair of this product can be dangerous and could result in injury or death.

Do not operate or perform any lubrication, maintenance or repair on this product, until you have read and understood the operation, lubrication, maintenance and repair information.

Safety precautions and warnings are provided in this manual and on the product. If these hazard warnings are not heeded, bodily injury or death could occur to you or other persons.

The hazards are identified by the "Safety Alert Symbol" and followed by a "Signal Word" such as "WARNING" as shown below.



The meaning of this safety alert symbol is as follows:

Attention! Become Alert! Your Safety is Involved.

The message that appears under the warning, explaining the hazard, can be either written or pictorially presented.

Operations that may cause product damage are identified by NOTICE labels on the product and in this publication.

DOOSAN cannot anticipate every possible circumstance that might involve a potential hazard, and common sense is always required. The warnings in this publication and on the product are therefore not all inclusive. Before any tool, procedure, work method or operating technique not specifically recommended by *DOOSAN* is used, you must be sure that it is safe for you and others. You should also ensure that the product will not be damaged or made unsafe by the operation, lubrication, maintenance or repair procedures you choose.

The information, specifications, and illustration in this publication are on the basis of information available at the time it was written. The specifications, torques, pressures, measurements, adjustments, illustrations, and other items can change at any time. These changes can affect the service given to the product. Obtain the complete and most current information before starting any job. *DOOSAN* dealers have the most current information available.

Safety

The safety rules and regulations in this section are representative of some, but not all rules and regulations noted under the Occupational Safety and Health Act (OSHA) and are paraphrased without representation that the OSHA rules and regulations have been reproduced verbatim.

Please refer to 1910. 178 in Federal Register Vol. 37, No. 202, the National Fire Protection Association No. 505 (NFPA), American National Standard, ANSI B56. 1 Safety Standard for Low lift and High Lift Trucks and subsequent revisions for a complete list of OSHA rules and regulations as to the safe operation of powered industrial lift trucks. Since regulations vary from country to country outside in U.S.A., operate this lift truck in accordance with local regulations.

DOOSAN lift trucks are manufactured according to the regulations and standards laid down in EU Machinery Directive 98/37/EC and EMC directive 89/336/EC. Please refer to the Directives 89/655/EC and 89/391/EC and its amendments for the safe use of DOOSAN lift trucks.

The most effective method of preventing serious injury or death to the lift truck operator or others is for the lift truck operator to be familiar with the proper operation of the lift truck, to be alert and to avoid actions or conditions which can result in an accident.

Do not operate a lift truck if in need of repair, defective or in any way unsafe. Report all defects and unsafe conditions immediately. Do not attempt any adjustments or repairs unless trained and authorized to do so.

Warning Signs and Labels

There are several specific safety signs on your lift truck. Their exact location and description of the hazard are reviewed in this section. Please take the time to familiarize yourself with these safety signs.

Make sure that you can read all warning and instruction labels. Clean or replace these labels if you cannot read the words or see the pictures. When cleaning the labels use a cloth, water and soap. Do not use solvent, gasoline, etc.

You must replace a label if it is damaged, missing or cannot be read. If a label is on a part that is replaced, make sure a new label is installed on the replaced part. See your dealer for new labels.

Training Required to Operate or Service Warning



Located on the right of the steering wheel.

WARNING

Improper operation or maintenance could result in injury or death. Do not operate or work on the lift truck unless you are properly trained. Read and understand the Operation and Maintenance Manual. Additional manuals are available from DOOSAN Lift Truck dealers.

This label also provides allowable lift truck capacity information.

General Warnings to Operator



Located on the right side of the operator's seat.

WARNING

Only trained and authorized personnel may operate this machine. For safe operation, read and follow the operation and maintenance Manual furnished with this lift truck and observe the following warnings:

1. Before starting machine. Check all controls and warning devices for proper operation.
2. Refer to machine identification plate for allowable machine capacity. Do not overload. Operate machines equipped with attachments as partially loaded machines when not handling a load.
3. Put directional control or shift lever in neutral before "ON - OFF" switch is turned on.
4. Start, turn and brake smoothly. Slow down for turns, slippery or uneven surfaces. Extremely poor surfaces should be repaired. Avoid running over loose objects or holes in the roadway surfaces. Use extreme caution when turning on inclines.
5. Travel with load as low as possible and tilted back. If load interferes with visibility, travel with load trailing.
6. On grade operations travel with load up grade.
7. Watch out for pedestrians and obstructions. Check overhead clearances.
8. Do not permit riders on forks or machine at any time.
9. Do not allow anyone to stand or pass under the elevated portion of any machine.
10. Be sure operating surface can safely support machine.
11. Operate machine and attachments only from operator's position.
12. Do not handle unstable or loosely stacked loads.
13. Use minimum tilt when picking up or depositing a load.

14. Use extreme care when handling long, high, or wide loads.
15. Forks should be completely under load and spread apart as far as load permits.
16. Machine should be equipped with overhead guard or equivalent protection. Where load requires it, use load backrest extension. Use extreme caution if operating without these devices.
17. Parking - Lower lifting mechanism to floor. Put directional control or shift lever in neutral. Set parking/secondary brake. Turn "ON - OFF" switch off. Check wheels if machine is on incline. Disconnect battery when storing electric machines.
18. Observe safety rules when handling fuel for engine powered machine and when changing batteries for electric machines.

Pressure Warning

⚠ WARNING

Contents under pressure may be hot. Allow to cool before opening.

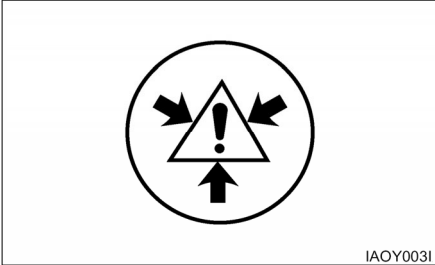

Located on the radiator top tank by the radiator cap.

Hand Placement Warning

⚠ WARNING



No hands. Do not place hands in this area. Do not touch, lean on, or reach through the mast or permit others to do so.

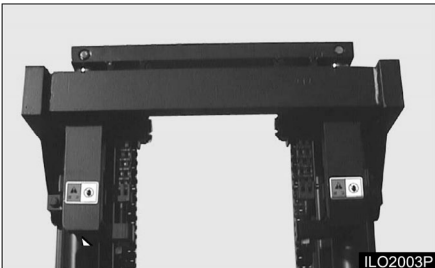

Located on the mast.

No Standing On Forks Warning, No Standing Under Forks Warning

⚠ WARNING

Do not stand or ride on the forks. Do not stand or ride on a load or pallet on the forks. Do not stand or walk under the forks.

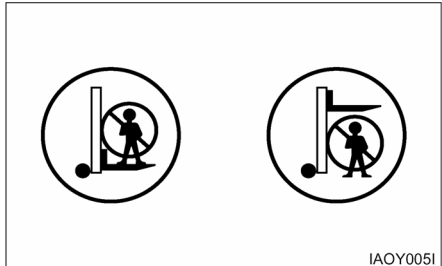

Located on the lift cylinder.

Load Backrest Must Be In Place Warning

⚠ WARNING

Operation without this device in place may be hazardous.



Located on the load backrest.

Overhead Guard Must Be In Place Warning

⚠ WARNING

Operation without this device in place may be hazardous. This guard conforms to A.N.S.I.B56.1 and F.E.M. Section IV. This design has been tested with an impact of (appropriate value).

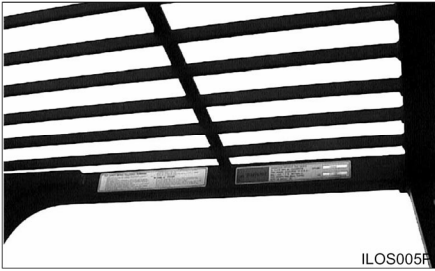

Located on the Overhead Guard.

Brake Pedal Adjustment Warning

⚠ WARNING

Improper adjustment could result in injury or death. It has to be adjusted by drawing dimension on free condition. For safe, don't unfasten clevis and nut. It has to be adjusted by trained personnel.

(SHOE Type Only)

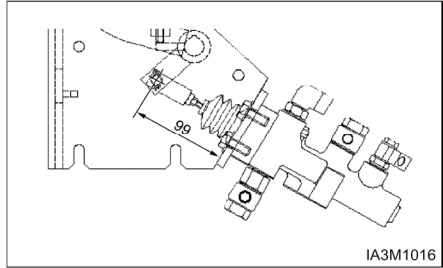

Located inside Brake pedal box.

(OCDB Type Only)

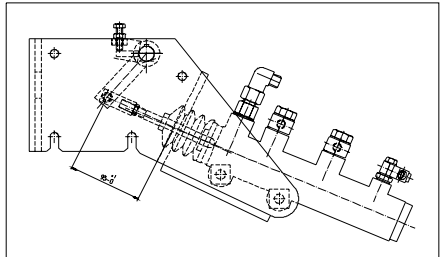

Parking brake



Pull the lever **BACK** to engage the parking brake.



Push the lever **FORWARD** to release the parking brake.

Applying the parking brake puts the transmission in **NEUTRAL**. The parking brake must be applied when leaving the lift truck and when starting the engine. If the operator leaves the seat without applying the parking brake, an audible alarm will sound.

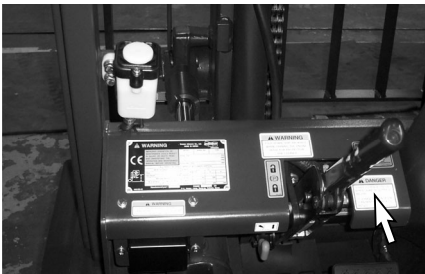

WARNING

When leaving machine apply parking brake!
Parking brake is not automatically applied.
Alarm will sound if parking brake is not applied.

WARNING

Correct adjustment is necessary to provide adequate braking. See the MAINTENANCE section for adjustment procedures. The lift truck may creep at engine idle and can cause damage, injury or death. Always apply the parking brake when leaving the lift truck. The parking brake is NOT automatically applied.

No Riders Warning

WARNING

To avoid personal injury, allow no riders. A lift truck is designed for only one operator and no riders.



Located beside the operator's station.

Moving Fan Warning

WARNING

To avoid personal injury, stay clear of moving fan.



Located on the shroud and upper cover.

General Hazard Information

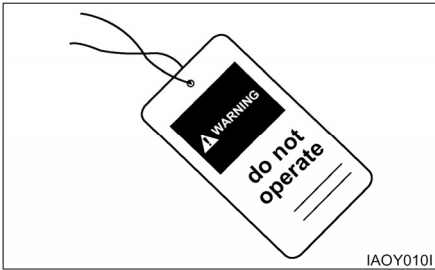

Attach a "Do Not Operate" or similar warning tag to start switch or controls before servicing or repairing the lift truck.

Do not start or service the lift truck when a "DO NOT OPERATE" or similar warning tag is attached to the start switch or controls.

Wear a hard hat, protective glasses and other protective equipment as required by job conditions.

Know the width of your attachments so proper clearance can be maintained when operating near fences, boundary obstacles, etc.

Do not wear loose clothing or jewelry that can catch on controls or other parts of the lift truck.

Keep the lift truck, especially the deck and steps, free of foreign material such as debris, oil tools and other items which are not part of the lift truck.

Secure all loose items such as lunch boxes, tools and other items which are not part of the lift truck.

Know the appropriate work-site hand signals and who gives them. Accept signals from one person only.

Always use the overhead guard. The overhead guard is intended to protect the lift truck operator from overhead obstructions and from falling objects.

A truck that is used for handling small objects or uneven loads must be fitted with a load backrest.

If the lift truck must be operated without the overhead guard in place due to low overhead clearance, use extreme care. Make sure there is no possibility of falling objects from any adjacent storage or work area. Make sure the load is stable and fully supported by the carriage and the load backrest extension (if equipped).

Do not raise loads any higher than necessary and never raise a load higher than 1830 mm (72 in) with the overhead guard removed.

Always use load backrest extension when the carriage or attachment does not fully support the load.

The load backrest extension is intended to prevent the load or any part of the load from falling backwards into the operator's station.

When operation the lift truck, do not depend only on flashing lights or back-up alarm (if equipped) to warn pedestrians.

Always be aware of pedestrians and do not proceed until the pedestrians are aware of your presence and intended actions and have moved clear of the lift truck and/or load.

Do not drive lift truck up to anyone standing in front of an object.

Obey all traffic rules and warning signs.

Keep hands, feet and head inside the operator station. Do not hold onto the overhead guard while operating the lift truck. Do not climb on any part of the mast or overhead guard or permit others to do so.

Do not allow unauthorized personnel to ride on the forks or any other part of the lift truck, at any time. When working in a building or dock, observe floor load limits and overhead clearances.

Inhaling Freon gas through a lit cigarette or other smoking method or inhaling fumes released from a flame contacting Freon can cause bodily harm or death. Do not smoke when servicing air conditioners or wherever Freon gas may be present.

Never put maintenance fluids into glass containers.

Use all cleaning solutions with care.

Do not use steam, solvent, or high pressure to clean electrical components.

Report all needed repairs.

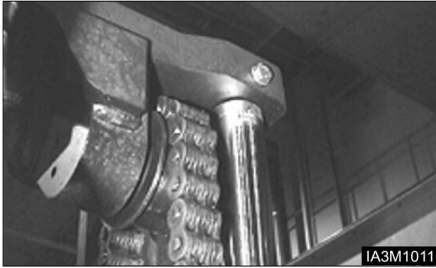

Inspect the part of the chain that is normally operated over the crosshead roller. When the chain bends over the roller, the movement of the parts against each other causes wears.

Inspect to be sure that chain link pins do not extend outside of the bore hole.

If any single link pin is extended beyond its connecting corresponding link, it should be suspected of being broken inside of its bore hole.

Inspect the chain anchor and the anchor links for wear.

Do not change any factory set adjustment values (including engine rpm setting) unless you have both authorization and training. Especially Safety equipment and switches may not be removed or adjusted incorrectly. Repairs, adjustments and maintenances that are not correct can make a dangerous operating condition.

For any checkup, repair, adjustments, maintenance and all other work concerning your forklift truck, please contact your *DOOSAN* dealer. We would like to draw your attention to the fact that any secondary damages due to improper handling, insufficient maintenance, wrong repairs or the use of other than original *DOOSAN* spare parts waive any liability by *DOOSAN*.

Operation Information

Mounting and Dismounting

Mount and dismount the lift truck carefully.

Clean your shoes and wipe your hands before mounting.

Face the lift truck when mounting and dismounting.

Use both hands face the lift truck when mounting and dismounting.

Use the handgrips for mounting and dismounting.

Do not try to climb on or off the lift truck when carrying tools or supplies.

Never get on or off a moving lift truck.

Do not use any controls as handholds when entering or leaving the operator's station.

Never get on or off a moving lift truck. Never jump off the lift truck.

Keep hands and steering wheel free of slippery material.

Before Starting the Lift Truck

Perform a walk-around inspection daily and at the start of each shift. Refer to the topic "Walk-around Inspection" in "Every 10 Service Hours or Daily" section of this manual.

Adjust the seat so that full brake pedal travel can be obtained with the operator's back against the seat back.

Make sure the lift truck is equipped with a lighting system as required by conditions.

Make sure all hydraulic controls are in the HOLD position.

Make sure the direction control lever is in the NEUTRAL position.

Make sure the parking brake is engaged.

Safety Section

Make sure no one is standing and/or working on, underneath or close to the lift truck before operating the lift truck.

Operate the lift truck and controls only from the operator's station.

Make sure the lift truck horn, lights, backup alarm (if equipped) and all other devices are working properly. Check for proper operation of mast and attachments.

Pay particular attention to unusual noises or erratic movement which might indicate a problem.

Make sure service and parking brakes, steering, and directional controls are operational.

Make sure all personnel are clear of lift truck and travel path.

Refer to the topic "Lift Truck Operation" in the "Operation Section" of this manual for specific starting instructions.

Starting the Lift Truck

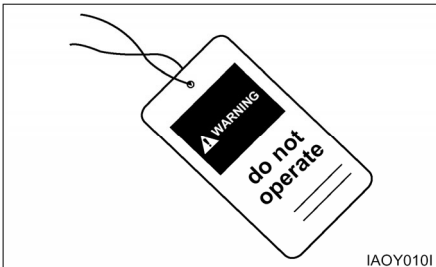

Do not start the engine or move any of the controls if there is a "DO NOT OPERATE" or similar warning tag attached to the start switch or controls.

Before Operating the Lift Truck

Test brakes, steering controls, horn and other devices for proper operation. Report faulty performance.

Do not operate lift truck until repaired.

Learn how your lift truck operates. Know its safety devices. Know how the attachments work.

Before moving the lift truck, look around. Start, turn and brake smoothly.

An operator must constantly observe his lift truck for proper operation.

Operating the Lift Truck

Always keep the lift truck under control.

Obey all traffic rules and warning signs.

Never leave the lift truck with the engine operating, or with the parking brake disengaged.

Operate the engine only in a well ventilated area.

Lower a mast, with or without load, before turning or traveling. Tip over could result. Watch out for overhead obstructions.

Always observe floor load limits and overhead clearance.

Start, turn, and brake smoothly, slow down for turns, grades, slippery or uneven surfaces.

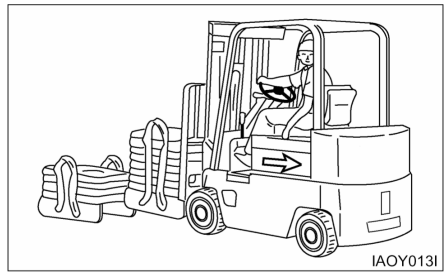

Use special care when operation on grades. Do not angle across or turn on grades. Do not use lift truck on slippery grades. Travel with forks downgrade when unloaded. Travel with load upgrade.

Do not overload, or handle offset, unstable, or loosely stacked loads. Refer to load capacity plate on the lift truck. Use extreme caution when handling suspended, long, high or wide load.



Tilt elevated load forward only when directly over unloading area and with load as low as possible.

Do not stunt ride or indulge in horseplay.

Always look and keep a clear view of the path of travel.

Travel in reverse if load or attachment obstructs visibility.

Use extreme caution if visibility is obstructed.

Stay in designated travel path, clear of dock edges, ditches, other drop-offs and surfaces which cannot safely support the lift truck.

Slow down and use extra care through doorways, intersections and other location where visibility is reduced.

Slow down for and avoid pedestrians, other vehicles, obstruction, pot holes and other hazards or objects in the path of travel.

Always use overhead guards except where operation conditions do not permit. Do not operate lift truck in high stacking areas without overhead guards.

When stacking, watch for falling objects. Use load backrest extension and overhead guard.

Refer to the topic "Operation Techniques" in the "Operation Section" of this manual.

Loading or Unloading Trucks/Trailers

Do not operate lift trucks on trucks or trailers which are not designed or intended for that purpose. Be certain truck or trailer brakes are applied and wheel chocks in place (or be certain unit is locked to the loading dock) before entering onto trucks or trailers.

If trailer is not coupled to tractor, make sure the trailer landing gear is properly secured in place. On some trailers, extra supports may be needed to prevent upending or corner dipping.

Be certain dock plates are in good condition and properly placed and secured. Do not exceed the rated capacity of dock boards or bridge plates.

Lift Truck Parking

When leaving the operator station, park the lift truck in authorized areas only. Do not block traffic.



- Park the lift truck level, with the forks lowered and the mast tilted forward until the fork tips touch the floor.
- Move the direction control lever to NEUTRAL.
- Engage the parking brake.
- Turn the key switch off and remove the key.
- Turn the disconnect switch to OFF and remove the key (if equipped).
- Block the drive wheels when parking on an incline.

Maintenance Information

Perform all maintenance unless otherwise specified as follows ;

- Park the lift truck in authorized areas only.
- Park the lift truck level, with the forks lowered and the mast tilted forward until the fork tips touch the floor.
- Place the transmission controls in neutral.
- Engage the parking brake.
- Stop the engine.
- Remove the start switch key and turn the disconnect switch OFF (if equipped).
- Block the drive wheels when parking on an incline.

Pressure Air

Pressure air can cause personal injury. When using pressure air for cleaning, wear a protective face shield, protective clothing and protective shoes.

The maximum air pressure must be below 205 kPa (30 psi) for cleaning purposes.

Fluid Penetration

Always use a board or cardboard when checking for a leak. Escaping fluid under pressure, even a pinhole size leak, can penetrate body tissue, causing serious injury, and possible death. If fluid is injected into your skin, it must be treated by a doctor familiar with this type of injury immediately.

Crushing or Cutting Prevention

Support equipment and attachments properly when working beneath them. Do not depend on hydraulic cylinders to hold it up. Any attachment can fall if a control is moved, or if a hydraulic line breaks.

Never attempt adjustments while the lift truck is moving or the engine is running unless otherwise specified.

Where there are attachment linkages, the clearance in the linkage area will increase or decrease with movement of the attachment.

Stay clear of all rotating and moving parts.

Keep objects away from moving fan blades.

They will throw or cut any object or tool that falls or is pushed into them.

Do not use a kinked or frayed wire rope cable. Wear gloves when handling the wire rope cable.

Retainer pins, when struck with force, can fly out and injure nearby persons. Make sure the area is clear of people when driving retainer pins.

Wear protective glasses when striking a retainer pin to avoid injury to your eyes.

Chips or other debris can fly off objects when struck. Make sure no one can be injured by flying debris before striking any object.

Falling Objects Protective Structure(FOPS)

This is an attached guard located above the operator's compartment and secured to the lift truck.

To avoid possible weakening of the Falling Objects Protective Structure (FOPS), consult a *DOOSAN* dealer before altering, by adding weight to, welding on, or cutting or drilling holes into the structure.

The overhead guard is not intended to protect against every possible impact. The overhead guard may not protect against some objects penetrating into the operator's station from the sides or ends of the lift truck.

The lift truck is equipped with an overhead guard and FOPS as standard. If there is a possibility of overhead objects falling through the guard, the guard must be equipped with smaller holes or a Plexiglas cover.

Any altering done that is not specifically authorized by *DOOSAN* invalidates *DOOSAN*'s FOPS certification.

The protection offered by this FOPS will be impaired if it has been subjected to structural damage.

Structural damage can be caused by an overturn accident, by falling objects, etc.

Do not mount any item such as fire extinguishers, first aid kits and lights by welding brackets to or drilling holes in any FOPS structure. See your *DOOSAN* dealer for mounting guidelines.

Burn Prevention

Coolant

At operating temperature, the engine coolant is hot and under pressure. The radiator and all lines to heaters or the engine contain hot water or steam. Any contact can cause severe burns.

Steam can cause personal injury.

Check the coolant level only after engine has been stopped and the filter cap is cool enough to remove with your bare hand.

Remove the cooling system filter cap slowly to relieve pressure.

Cooling system additive contains alkali that can cause personal injury. Avoid contact with the skin and eyes and do not drink.

Allow cooling system components to cool before draining.

Oils

Hot oil and components can cause personal injury. Do not allow hot oil or components to contact the skin.

At operation temperature, the hydraulic tank is hot and can be under pressure.

Remove the hydraulic tank filter cap only after the engine has been stopped and the filter cap is cool enough to remove with your bare hand.

Remove the hydraulic tank filter cap slowly to relieve pressure.

Relieve all pressure in air, oil fuel or cooling systems before any lines, fittings or related items are disconnected or removed.

Batteries

Batteries give off flammable fumes which can explode.

Do not smoke when observing the battery electrolyte levels.

Electrolyte is an acid and can cause personal injury if it contacts skin or eyes.

Always wear protective glasses when working with batteries.

Fire or Explosion Prevention

All fuels, most lubricants and some coolant mixtures are flammable.

Fuel leaked or spilled onto hot surfaces or electrical components can cause a fire.

Do not smoke while refueling or in a refueling area.

Do not smoke in areas where batteries are charged, or where flammable materials are stored.

Batteries in series can be located in separate compartments.

When using jumper cables always connect positive(+) cable to positive(+) terminal of battery connected to starter solenoid and negative(-) cable from external source to starter negative(-) terminal.

(If not equipped with starter negative(-) terminal, connect to engine block.)

See the Operation Section of this manual for specific starting instructions.

Clean and tighten all electrical connections. Check daily for loose or frayed electrical wires. Have all loose or frayed electrical wires tightened, repaired or replaced before operation the lift truck.

Keep all fuels and lubricants stored in properly marked containers and away from all unauthorized persons.

Store all oily rags or other flammable material in a protective container, in a safe place.

Do not weld or flame cut on pipes or tubes that contain flammable fluids. Clean them thoroughly with nonflammable solvent before welding or flame cutting on them.

Remove all flammable materials such as fuel, oil and other debris before they accumulate on the lift truck.

Do not expose the lift truck to flames, burning brush, etc., if at all possible.

Shields, which protect hot exhaust components from oil or fuel spray in the event of a line, tube or seal failure, must be installed correctly.

Do not operate in areas where explosive gases exist or are suspected.

Fire Extinguisher

Have a fire extinguisher-type BC and 1.5KG minimum capacity-on rear overhead guard leg with latch and know how to use it. Inspect and have it serviced as recommended on its instruction plate.

Ether

Ether is poisonous and flammable.

Breathing ether vapors or repeated contact of ether with skin can cause personal injury.

Use ether only in well-ventilated areas.

Do not smoke while changing ether cylinders.

Use ether with care to avoid fires.

Do not store replacement ether cylinders in living areas or in the operator's compartment.

Do not store ether cylinders in direct sunlight or at temperatures above 39°C (102°F).

Discard cylinders in a safe place. Do not puncture or burn cylinders.

Keep ether cylinders out of the reach of unauthorized personnel.

Lines, Tubes and Hoses

Do not bend or strike high pressure lines. Do not install bent or damaged lines, tubes or hoses.

Repair any loose or damaged fuel and oil lines, tubes and hoses. Leaks can cause fires. Contact your DOOSAN dealer for repair or replacement.

Check lines, tubes and hoses carefully. Do not use your bare hand to check for leaks. Use a board or cardboard to check for leaks. See Fluid Penetration in the Safety Section for more details. Tighten all connections to the recommended torque. Replace if any of the following conditions are found.

- End fittings damaged or leaking.
- Outer covering chafed or cut and wire reinforcing exposed.
- Outer covering ballooning locally.
- Evidence of kinking or crushing of the flexible part of hose.
- Armoring embedded in the outer cover.
- End fittings displaced.

Make sure that all clamps, guards and heat shields are installed correctly to prevent vibration, rubbing against other parts, and excessive heat during operation.

Tire Information

Explosions of air-inflated tires have resulted from heat-induced gas combustion inside the tires. The heat, generated by welding or heating rim components, external fire, or excessive use of brakes can cause gaseous combustion.

A tire explosion is much more violent than a blowout. The explosion can propel the tire, rim and axle components as far as 500 m (1500 ft) or more from the lift truck. Both the force of the explosion and the flying debris can cause personal injury or death, and property damage.

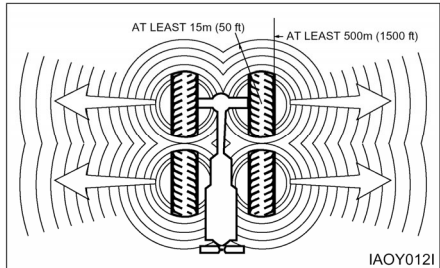

Do not approach a warm tire closer than the outside of the area represented by the shaded area in the above drawing.

Dry nitrogen(N₂) gas is recommended for inflation of tires. If the tires were originally inflated with air, nitrogen is still preferred for adjusting the pressure. Nitrogen mixes properly with air.

Nitrogen inflated tires reduce the potential of a tire explosion, because nitrogen does not support combustion. Also, nitrogen helps prevent oxidation and the resulting deterioration of rubber and corrosion of rim components.

Proper nitrogen inflation equipment and training in its use are necessary to avoid over-inflation. A tire blowout or rim failure can result from improper or misused equipment.

Stand behind the tread and use a self-attaching chuck when inflation a tire.

Servicing, changing tires and rims can be dangerous and should be done only by trained personnel using proper tools and procedures. If correct procedures are not followed while servicing tires and rims, the assemblies could burst with explosive force and cause serious personal injury or death. Follow carefully the specific information provided by your tire or rim servicing personnel or dealer.

Operator Restraint System (If Equipped)

Warning Signs and Labels

Your DOOSAN lift truck has the following tipover warning decals.

Make sure that you can read all safety signs. Clean or replace these if you cannot read the words or see the pictures. When cleaning the labels use a cloth, water and soap. Do not use solvent, gasoline, etc. You must replace a label if it is damaged, missing or cannot be read. If a label is on a part that is replaced, make sure a new label is installed on the replaced part. See your DOOSAN Lift Truck dealer for new labels.

The most effective method of preventing serious injury or death to yourself or others is to familiarize yourself with the proper operation of the lift truck, to be alert, and to avoid actions or conditions which can result in an accident.



Tipover can occur if the truck is improperly operated. In the event of a tipover, injury or death could result.

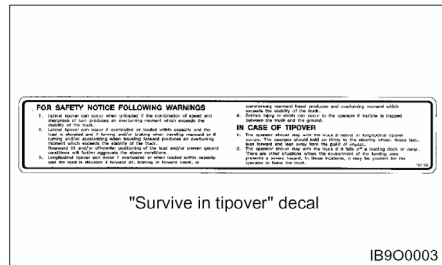
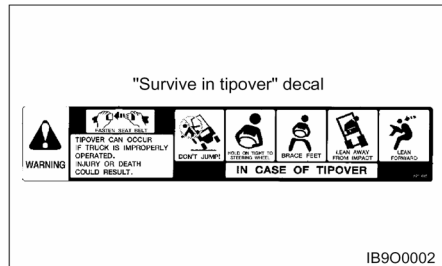

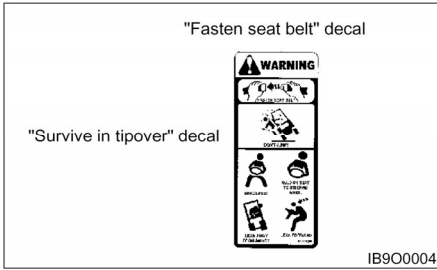

The "Survive in tipover" warning is located on the overhead guard. It shows the proper use of the operator restraint system.

Seat Adjustment

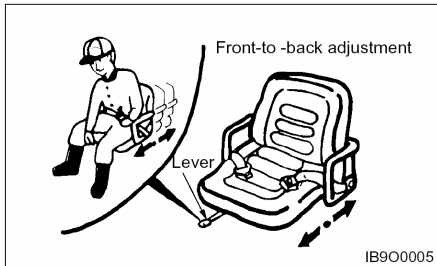

Move the lever, slide the seat to the desired position, and release the lever.

Adjust the seat before operating the lift truck. After adjusting, set the seat to make sure it is properly locked. DO NOT adjust the seat while the truck is in motion.

⚠ WARNING

Do NOT place your hand or fingers under the seat. Injury may occur as the seat suspension mechanism moves up and down.

NOTICE
Before getting on the truck, adjust the level of the suspension using the grip in the rear of the seat.



⚠ WARNING

When raising and lowering the seat backrest, avoid placing hand or fingers in the hinge area indicated by the circle. Injury may occur.

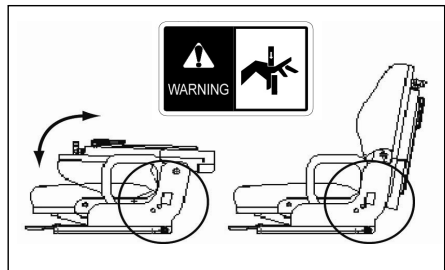

If Optional Suspension Seat (weight adjusting type) Equipped

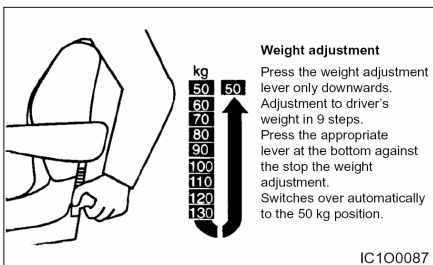
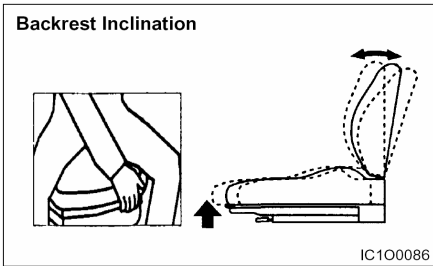
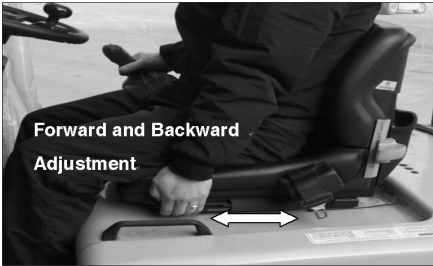

Seat Belt

The Operator Restraint System, Prevents the operator from jumping from the operator's compartment in the event of a forward or side tipover. The system is designed to keep the operator on the seat and in the operator's compartment in the event of a tipover.

Inspection

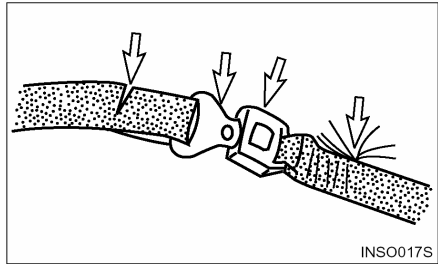

1. If the seat belt is torn, if pulling motion is interrupted during extension of the belt, or if the belt cannot be inserted into the buckle properly, replace the seat belt assembly.

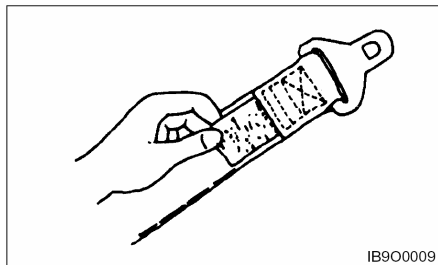

2. Belt Maintenance – Every 500 service hours. Check that the belt fastening works properly and that winding device is free from run lock when jerked. Check that the belt is suitably fastened to the seat. Check that the seat is correctly secured to the hood and the chassis. On visual inspection, fastenings must be intact, otherwise, contact the safety manager.

⚠ WARNING

Your **DOOSAN** truck comes equipped with a **DOOSAN** operator restraint system. Should it become necessary to replace the seat for any reason, it should only be replaced with another **DOOSAN** operator restraint system.

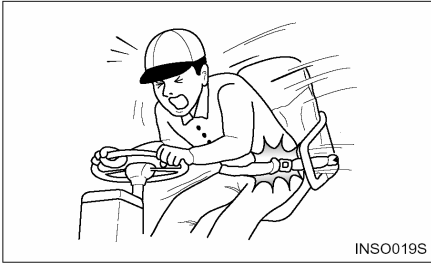

3. In the event of a tipover, the seat and restraint system should be inspected for damage and replaced, if necessary.

NOTE: Operator restraints shall be examined at the regular truck service intervals. It is recommended that they be replaced if any of the following conditions are found:

- Cut or frayed strap
- Worn or damaged hardware including anchor points
- Buckle or retractor malfunction
- Loosen stitching

⚠ WARNING

The seat belt may cause the operator to bend at the waist. If you are pregnant or have suffered from some abdominal disease, consult a doctor before you use the seat belt.

Fasten the Seat Belt

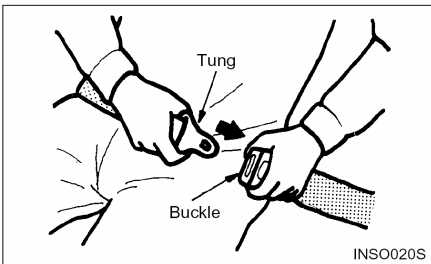

1. Grip the plate (connector) of the belt and pull the belt from the retractor. Then insert the plate into the slot of the buckle until a snap is heard. Pull on the belt to confirm it is latched.
2. Make sure the belt is not twisted.

⚠ WARNING

If you fasten the belt across your abdomen, the belt may injure your abdomen in an accident.

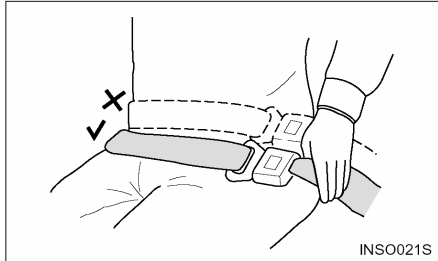

3. Be sure to fasten the belt across your hips, not across your abdomen.

NOTE: The belt is designed to automatically adjust to your size and movement. A quick pull on the belt will confirm that the automatic adjuster will hold the belt position in the event of an accident.

Release the Seat Belt

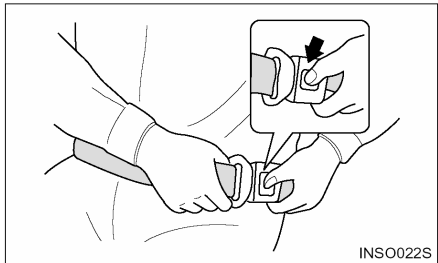

Push the button of the buckle to release the belt. The belt will automatically retract when released. Hold the plate of the belt and allow the belt to slowly retract.

Avoiding Lift Truck Tipovers

Lift Truck Stability

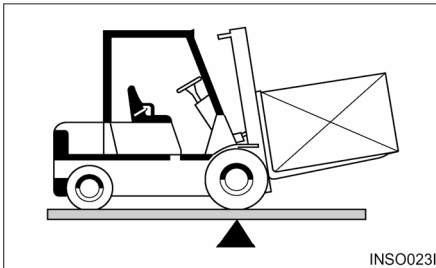

Counterbalanced lift truck design is based on the balance of two weights on opposite sides of a fulcrum (the front axle). The load on the forks must be balanced by the weight of the lift truck.

The location of the center of gravity of both the truck and the load is also a factor. This basic principle is used for picking up a load. The ability of the lift truck to handle a load is discussed in terms of center of gravity and both forward and sideways stability.

Center of Gravity (CG)

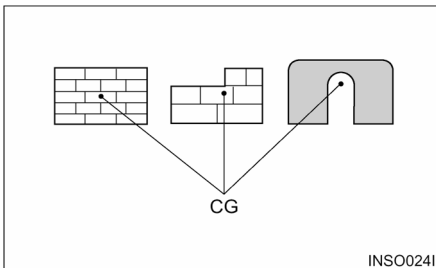

The point within an object, at which the whole weight of the object may be regarded as being concentrated, is called the center of gravity or CG. If the object is uniform, its geometric center will coincide with its CG. If it is not uniform, the CG could be at a point outside of the object. When the lift truck picks up a load, the truck and load have a new combined CG.

Stability and Center of Gravity

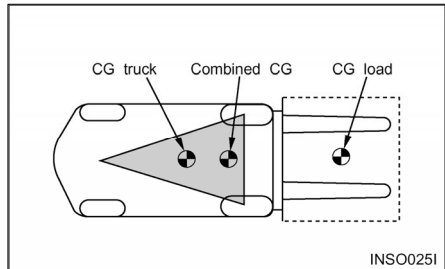

The stability of the lift truck is determined by the location of its CG; or, if the truck is loaded, the combined CG of the truck and load. The lift truck has moving parts and, therefore, has a CG that moves. The CG moves forward or backward as the mast is tilted forward or backward. The CG moves up or down as the mast moves up or down. The CG and, therefore, the stability of the loaded lift truck, is affected by a number of factors such as:

- the size, weight, shape and position of the load
- the height to which the load is lifted
- the amount of forward or backward tilt
- tire pressure
- dynamic forces created when the lift truck is accelerated, braked or turned
- condition and grade of surfaces on which the lift truck is operated

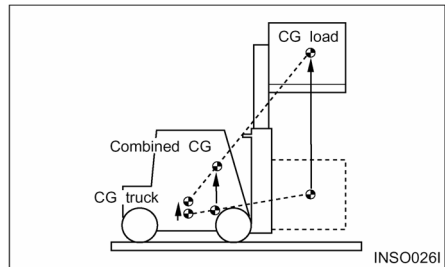

These same factors are also important for unloaded lift trucks. They tip over sideways easier than a loaded lift truck carrying its load in the lowered position.

Lift Truck Stability Base

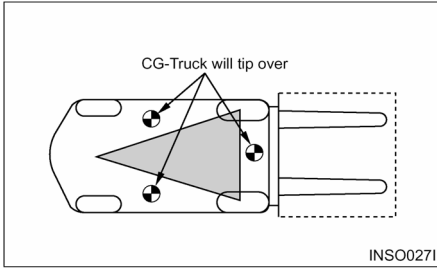

For the lift truck to be stable (not tip over forward or to the side), the CG must stay within the area of the lift truck stability base - a triangular area between the front wheels and the pivot of the steer wheels. If the CG moves forward of the front axle, the lift truck will tip forward. If the CG moves outside of the line on either side of the stability base, the lift truck will tip to the side.

WARNING

Dynamic forces (braking, acceleration, turning) also affect stability and can produce tipover even when the CG is within the stability triangle.

Capacity Load (Weight and Load Center)

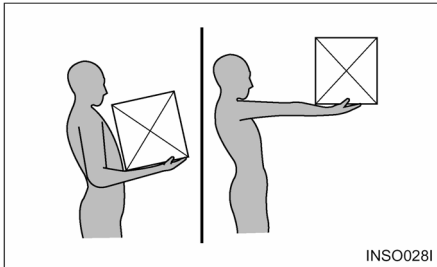

The capacity load of the lift truck is shown on the capacity/nameplate riveted to the truck. It is determined by the weight and load center. The load center is determined by the location of the CG of the load.

The load center shown on the nameplate is the horizontal distance from the front face of the forks, or the load face of an attachment, to the CG of the load.

The location of the CG in the vertical direction is the same as the horizontal dimension.

Remember that, unless otherwise indicated, the capacity load shown on the nameplate is for a standard lift truck with standard backrest, forks and mast, and having no special-purpose attachment. In addition, the capacity load assumes that the load center is no further from the top of the forks than it is from the face of the backrest. If these conditions do not exist, the operator may have to reduce the safe operating load because the truck stability may be reduced. The lift truck should not be operated if its capacity/nameplate does not indicate capacity load.

NOTE: If the load is not uniform, the heaviest portion should be placed closer to the backrest and centered on the forks.

NOTICE

1. Capacity/Nameplates originally attached to forklifts sold by *DOOSAN* shall not be removed, altered or replaced without *DOOSAN*'s approval.
 2. *DOOSAN* assumes no responsibility for forklifts placed in service without a valid *DOOSAN* Nameplate.
 3. If necessary to change your specification, contact your *DOOSAN* lift truck dealer.
-

Safety Rules

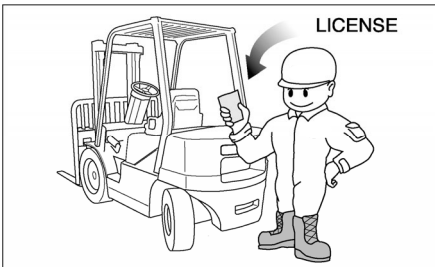

Only properly trained and authorized personnel should operate forklift trucks. Wear a hard hat and safety shoes when operating a lift truck. Do not wear loose clothing.

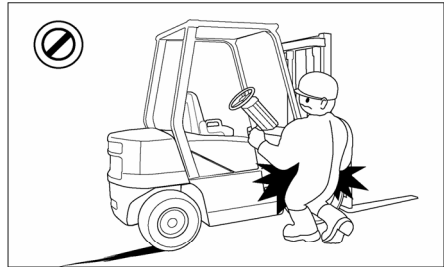

Do not operate a lift truck unless you are in the operator's seat. Keep arms, legs and head inside the confines of the operator's area. Keep hands and feet out of the mast assembly.

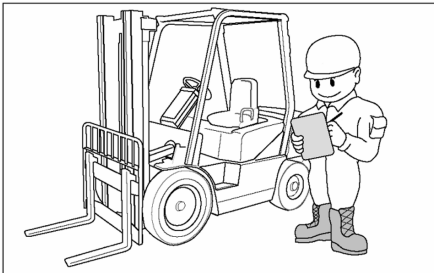

Inspect and check the condition of your forklift truck using the operator's check list before starting work. Immediately report to your supervisor any obvious defects or required repairs.

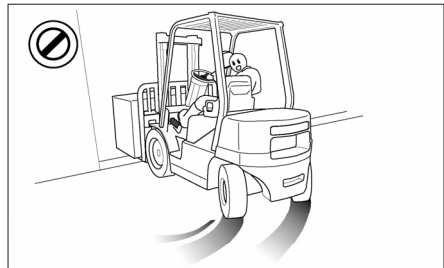

Do not start, stop, turn or change direction suddenly or at high speed. Sudden movement can cause the lift truck to tip over. Slow the speed of your truck and use the horn near corners, exits, entrances, and near people.

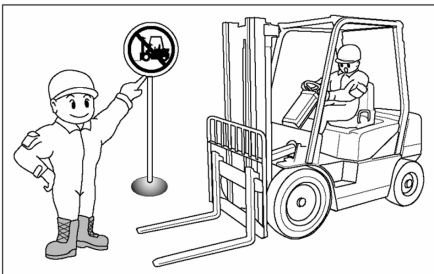

Do not operate your truck in unauthorized areas. Know your forklift truck and think safety. Do not compromise safety. Follow all safety rules and read all warning signs.

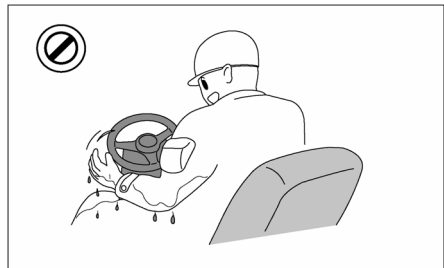

Never operate a lift truck with wet hands or shoes. Never hold any controls with grease on your hands. Your hands or feet will slide off of the controls and cause an accident.

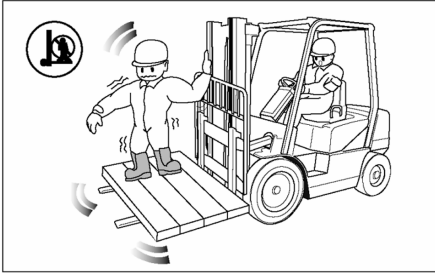

Do not raise anyone on the forks of your lift truck unless using an approved safety cage.
Do not let other people ride on the truck.
Lift trucks are designed to carry loads, not people.

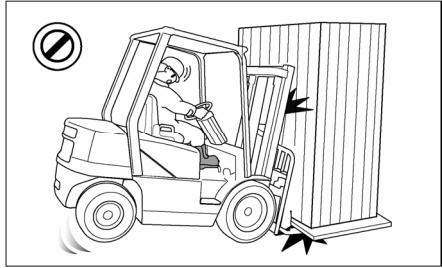

Do not overload. Always handle loads within the rated capacity shown on the capacity plate.
Do not add extra counterweight to the truck.
An overload can cause the truck to roll over and cause injury to personnel and damage to the lift truck.

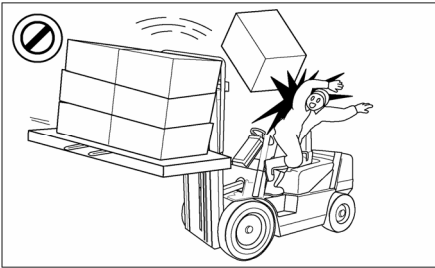

Do not operate your truck without the load backrest extension and overhead guard. Keep the load against the backrest with the mast tilted backward.

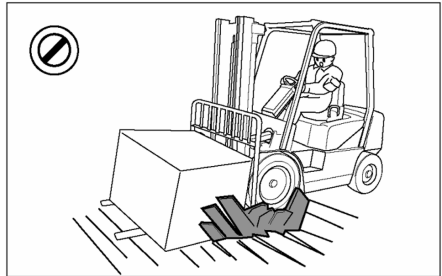

Do not drive on soft ground.
Observe all signs, especially those on maximum permitted floor loadings, elevator capacities and clearance heights.
Handle loads carefully and check them closely for stability and balance.

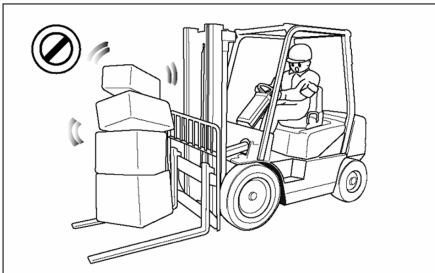

Do not lift or move loads that are not safe. Do not pick up an off center load. Such a load increases the possibility of a tipover to the side. Make sure loads are correctly stacked and positioned across both forks. Always use the proper size pallet. Position the forks as wide as possible under the load. Position loads evenly on the forks for proper balance. Do not lift a load with one fork.



Do not drive on slippery surfaces.
Sand, gravel, ice or mud can cause a tipover. If unavoidable, slow down.

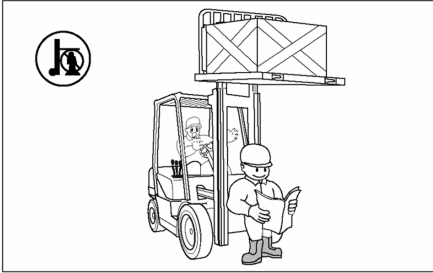

Do not permit anyone to stand or walk under the load or lifting mechanism. The load can fall and cause injury or death to anyone standing below.

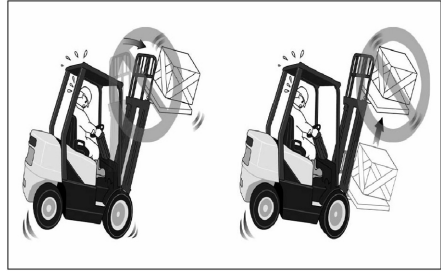

Do not elevate the load with the mast tilted forward. Do not tilt the elevated loads forwards. This will cause the lift truck to tip over forward.

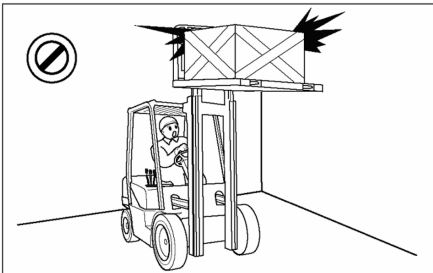

Look out for overhead obstructions when raising or stacking loads. Do not travel with a raised load. Do not travel with the mast raised. The lift truck can roll over and cause injury or death to you or other personnel.

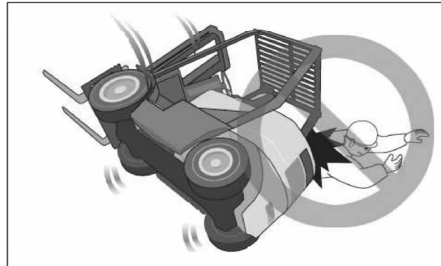

Do not jump off if your truck starts to tip over. Stay in your seat to survive.

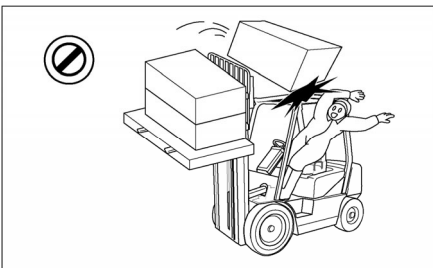

Do not move loose loads that are higher than the load backrest. Be alert for falling loads when stacking. Travel with the load tilted back and the forks as low as possible. This will increase stability to the truck and load and permit better visibility for you.

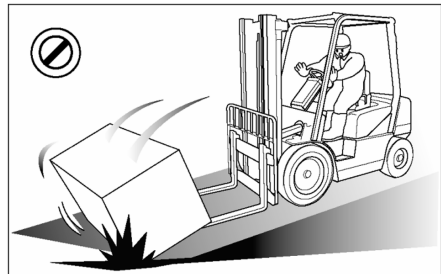

Go up ramps in forward direction and down ramps in reverse direction when moving loads. Never elevate a load with the forklift truck on an incline. Go straight off and straight down. Use an assistant when going up or down a ramp with a bulky load.

Safety Section

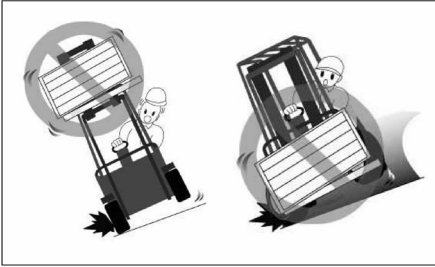

Do not stack or turn on ramps.
Do not attempt to pick-up or deposit a load unless the lift truck is level. Do not turn on or drive across an incline.

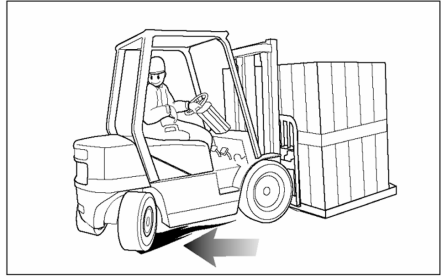

Do not drive in forward direction when loads restrict your visibility. Operate your lift truck in reverse to improve visibility except when moving up a ramp.

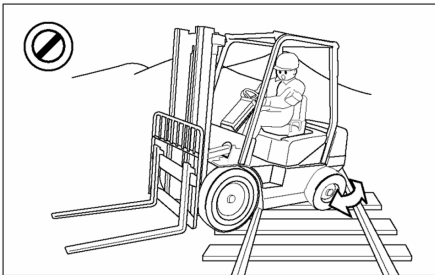

Do not go over rough terrain. If unavoidable, slow down. Cross railroad tracks slowly and diagonally whenever possible. A railroad crossing can give a loaded forklift truck a real jolt. For smoother crossing, cross the railroad diagonally so one wheel crosses at a time.

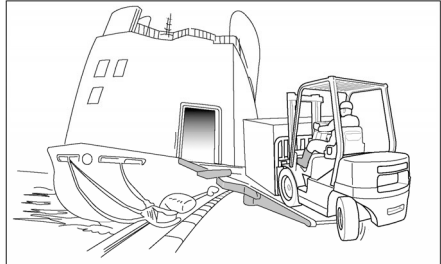

Be careful when operating a lift truck near the edge of a loading dock or ramp. Maintain a safe distance from the edge of docks, ramps and platforms. Always watch tail swing. The truck can fall over the edge and cause injury or death.

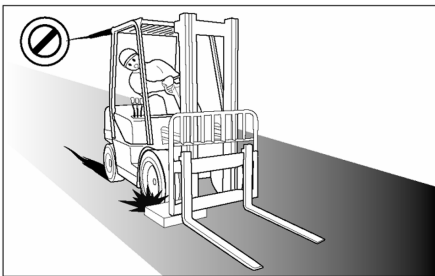

Avoid running over loose objects. Look in the direction of travel. Look out for other persons or obstructions in your path of travel. An operator must be in full control of his lift truck at all times.

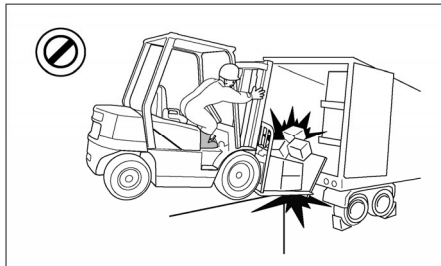

Do not operate on bridge plates unless they can support the weight of the truck and load. Make sure that they are correctly positioned. Put blocks on the vehicle you enter to keep it from moving.

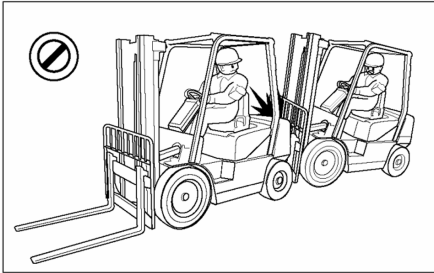

Do not operate your truck close to another truck. Always keep a safe distance from other trucks and make sure there is enough distance to stop safely. Never overtake other vehicles.

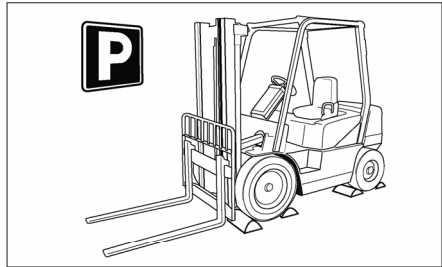

Park your lift truck in authorized areas only. Fully lower the forks to the floor, put direction lever in NEUTRAL position, engage the parking brake, and turn the key to the OFF position. Remove the key and put blocks behind the wheels to prevent the truck from rolling. Shut off your forklift truck when leaving it unattended. Check the condition of your forklift truck after the day's work.

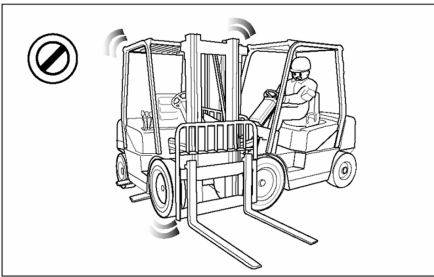

Do not use your lift truck to push or tow another truck. Do not let another push or tow your truck. If a truck will not move, call a service technician.

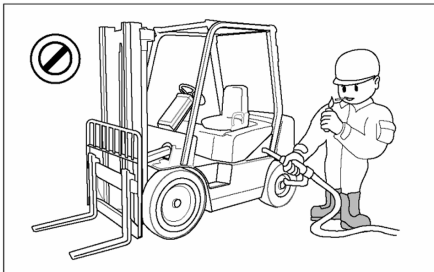

Forklift trucks may only be refueled at specially reserved locations. Switch off the engine when refueling. Smoking and handling of naked flames during refueling are strictly prohibited. This prohibition also applies during the changing of the LPG (liquefied propane gas) tank. Mop up spilled fuel and do not forget to close the fuel tank before restarting the engine.

How to Survive in a Tipover (If Operator Restraint System Equipped)

WARNING

In the event of a tipover, the risk of serious injury or death will be reduced if the operator is using the operator restraint system and follows the instructions provided.



INSO046I

Always use operator restraint system.



INSO047I

Don't jump.

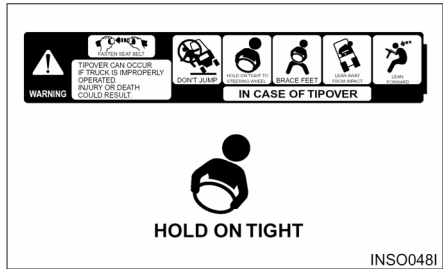

INSO048I

Hold on tight.

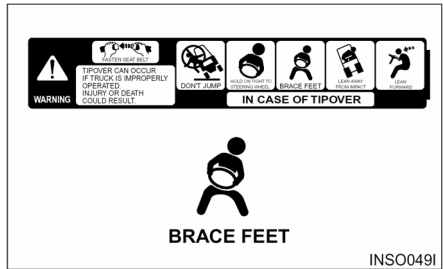

INSO049I

Brace your feet and keep them within the operator's compartment.

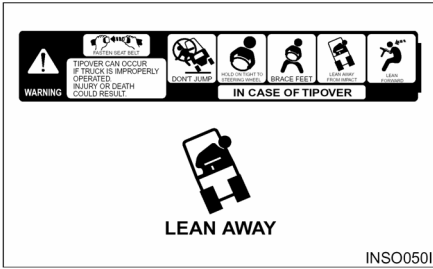

Lean away from the direction of fall.

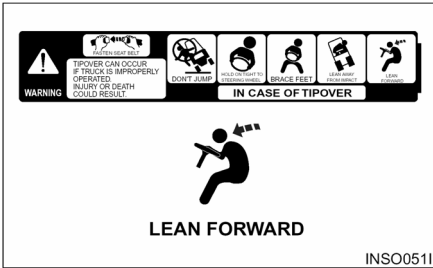

Lean forward.

Specifications

CHARACTERISTICS									
1	Manufacturer	UNIT	DOOSAN		DOOSAN		DOOSAN		
2	Model		D36S-2	G36S-2	D40S-2	G40S-2	D46S-2	G46S-2	
3	Capacity	at rated load center	3500		4000		4500		
4	Load center	distance	600		600		600		
5	Power type	electric, diesel, gas, LP-GAS	diesel	LP-GAS	diesel	LP-GAS	diesel	LP-GAS	
6	Operator type	stand-on, rider seated	rider-seated		rider-seated		rider-seated		
7	Tire type	c = cushion, p = pneumatic	p		p		p		
8	Wheels (x = driven)	number, front/rear	X2/2		X2/2		X2/2		
DIMENSIONS									
9	Lift with STD	maximum fork height with rated load	mm	3000	3000	3000	3000	3000	
10	two - stage mast	free lift	mm	155	155	155	155	155	
11		special free lift	mm						
12	Fork carriage	ISO class		II	II	II	II	II	
13	Forks	thickness X width X length	mm	50X150X1050	50X150X1050	50X150X1050	50X150X1050	50X150X1200	
14	Tilt of mast	forward/backward	deg	8/10	8/10	8/10	8/10	8/10	
15	Overall dimensions	length to fork face	mm	3075	3135	3135	3190	3190	
16		width (standard tire)	mm	1365	1445	1445	1445	1445	
17		width (option : dual tire)	mm	1740	1740	1740	1740	1740	
18		length to rear wheel	mm	2225	2230	2230	2230	2230	
19		most lowered height	mm	2225	2230	2230	2230	2230	
20		most extended height	mm	4265	4270	4270	4420	4420	
21		overhead guard height	mm	2225	2230	2230	2230	2230	
22		seat height	mm						
21	Outside turning radius		mm	2770	2820	2820	2865	2865	
22	Load moment constant (from center of front wheel to fork face)		mm	561	561	561	561	561	
23	90° stacking aisle	add load length and clearance	mm	3330	3390	3390	3425	3425	
23a	90° intersecting aisle		mm	2345	2400	2400	2460	2460	
PERFORMANCE									
24	Speeds	traveling, loaded/unloaded	km/h	24/25	21/22	24/25	20/21	24/25	20/21
25		lifting, loaded/unloaded	mm/s	520/540	500/540	520/540	500/540	520/540	500/540
26		lowering, loaded/unloaded	mm/s	480/450		480/450		480/450	
28	Drawbar pull	at 1.6 km/h, loaded	kg	3300	3355	3300	3430	3400	3410
30	Gradeability	at 1.6 km/h, loaded	%	38	36	35	33.5	32	31
31	Acceleration time	traveling, loaded/unloaded	s						
WEIGHT									
32	Total weight	unloaded	kg	5840	6170	6170	6560	6560	
33	Axle load	at loaded, front/rear	kg	8340/1000	9050/1120	9050/1120	9660/1200	9660/1200	
34		without loaded, front/rear	kg	2810/3030	2730/3440	2730/3440	2725/3835	2725/3835	
CHASSIS									
35	Tires	number of front/rear		2/2	2/2	2/2	2/2	2/2	
36		size, front		8.25X15-14	300X15-18	300X15-18	300X15-18	300X15-18	
37		size, rear		7.00X12-12	7.00X12-12	7.00X12-12	7.00X12-12	7.00X12-12	
38	Wheelbase		mm	2000	2000	2000	2000	2000	
39	Tread	front/rear (standard tire)	mm	1132/1115	1147/1115	1147/1115	1147/1115	1147/1115	
		(option dual tire)	mm	1290/1115	1290/1115	1290/1115	1290/1115	1290/1115	
40	Ground clearance	loaded, at the lowest point	mm	160	160	160	160	160	
41			loaded, at center of wheelbase	mm	205	205	205	205	205
42	Brakes	service brake		shoe/disc	shoe/disc	shoe/disc	shoe/disc	shoe/disc	
43			parking brake		toggle	toggle	toggle	toggle	
DRIVE									
45	Battery	voltage/capacity	V/AH	24/75	12/75	24/75	12/75	24/75	12/75
49	Engine	manufacturer/model		DOOSAN /DB58	GM V6 4.3L	DOOSAN /DB58	GM V6 4.3L	DOOSAN /DB58	GM V6 4.3L
50		rated output (at rpm)	ps/rpm	92/2200	86.7/2400	92/2200	86.7/2400	92/2200	86.7/2400
		(DIN)	kW/hp	69/91.6	3.8/85.5	69/91	63.8/85.5	68/91	63.8/85.5
51		max. torque/rpm	kgm/rpm	31.5/1600	30.5/1400	31.5/1600	30.5/1400	31.5/1600	30.5/1400
52		cycle/cylinders/displacement	cc	4/6/5785	4/6/4294	4/6/5785	4/6/4294	4/6/5785	4/6/4294
		fuel consumption	l/hr	6.5	-	6.5	-	6.5	-
55	Transmission	type		powershift	powershift	powershift	powershift	powershift	
56			no. speeds forward/reverse		2/2	2/2	2/2	2/2	2/2
57	Operating pressure	system/attachment	bar	190/140	190/140	190/140	210/140	210/140	

DOOSAN		DOOSAN		DOOSAN		1
D40SC-2	G40SC-2	D48SC-2	G48SC-2	D50SC-2	G50SC-2	2
4000		4500		5000		3
500		500		500		4
diesel	LP-GAS	diesel	LP-GAS	diesel	LP-GAS	5
riclr - seated		riclr - seated		riclr - seated		6
p		p		p		7
X2/2		X2/2		X2/2		8
3000		3000		3000		9
155		155		155		10
						11
II		II		IV		12
50 X 150 X 1050		50 X 150 X 1050		50 X 150 X 1200		13
8/10		8/10		8/10		14
3075		3135		3190		15
1365		1445		1445		16
1740		1740		1740		17
2225		2230		2230		18
4265		4270		4420		19
2225		2230		2230		20
						21
2770		2820		2865		22
561		561		561		23
3330		3380		3425		24
2345		2400		2460		23a
24/25	20/21	24/25	20/21	24/25	20/21	24
520/540	500/540	520/540	500/540	510/540	490/540	25
480/450		480/450		480/450		26
3300	3430	3300	3410	3400	3400	28
36	33.5	33	31	32	29.4	30
						31
5940		6560		6560		32
8930/910		9860/1200		10380/1180		33
2810/3030		2725/3835		2725/3830		34
2/2		2/2		2/2		35
8.25 X 15-14		300 X 15-18		300 X 15-18		36
7.00X 12-12		7.00X 12-12		7.00X 12-12		37
2000		2000		2000		38
1132/1115		1147/1115		1147/1115		39
1290/1115		1290/1115		1290/1115		40
160		160		160		41
205		205		205		42
shoe/disc		shoe/disc		shoe/disc		43
toggle		toggle		toggle		43
24/75	12/75	24/75	12/75	24/75	12/75	45
DOOSAN /DB58	GM V6 4.3L	DOOSAN /DB58	GM V6 4.3L	DOOSAN /DB58	GM V6 4.3L	49
92/2200	86.7/2400	92/2200	86.7/2400	92/2200	86.7/2400	50
6991	63.8/65.5	6991	63.8/65.5	6991	63.8/65.5	51
31.5/1600	30.5/1400	31.5/1600	30.5/1400	31.5/1600	30.5/1400	52
4/6/5/785	4/6/4/294	4/6/5/785	4/6/4/294	4/6/5/785	4/6/4/294	52
6.5	-	6.5	-	6.5	-	55
Powershift		Powershift		Powershift		56
22		22		22		56
190/140		210/140		210/140		57

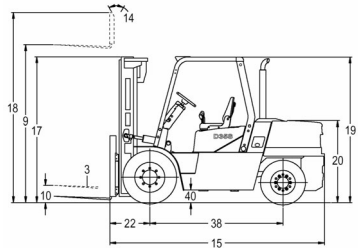
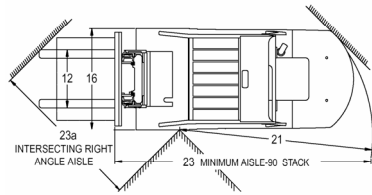

Specifications

CHARACTERISTICS					
1	Manufacturer		UNIT	DOOSAN	DOOSAN
2	Model			G35S-2(TIER II)	G40S-2(TIER II)
3	Capacity	at rated load center	kg	3500	4000
4	Load center	distance	mm	600	600
5	Power type	electric, diesel, gas, LP-GAS		LP-GAS	LP-GAS
6	Operator type	stand-on, rider seated		rider-seated	rider-seated
7	Tire type	c = cushion, p = pneumatic		p	p
8	Wheels (x = driven)	number, front/rear		X2/2	X2/2
DIMENSIONS					
9	Lift with STD	maximum fork height with rated load	mm	3000	3000
10	two - stage mast	free lift	mm	155	155
11		special free lift	mm		
12	Fork carriage	ISO class		II	III
13	Forks	thickness X width X length	mm	50X150X1050	50X150X1050
14	Tilt of mast	forward/backward	deg	8/10	8/10
15	Overall dimensions	length to fork face	mm	3075	3135
16		width (standard tire)	mm	1365	1445
17		mast lowered height	mm	2225	2230
18		mast extended height	mm	4265	4270
19		overhead guard height	mm	2225	2230
21	Outside turning radius		mm	2770	2820
22	Load moment constant (from center of front wheel to fork face)		mm	561	561
PERFORMANCE					
24	Speeds	traveling, loaded/unloaded	km/h	21/22	20/21
25		lifting, loaded/unloaded	mm/s	500/540	500/540
26		lowering, loaded/unloaded	mm/s	480/450	480/450
28	Drawbar pull	at 1.6 km/h, loaded	kg	3355	3430
30	Gradeability	at 1.6 km/h, loaded	%	36	33.5
WEIGHT					
32	Total weight	unloaded	kg	5840	6170
33	Axle load	at loaded, front/rear	kg	8340/1000	9050/1120
34		without loaded, front/rear	kg	2810/3030	2730/3440
CHASSIS					
35	Tires	number of front/rear		2/2	2/2
36		size, front		8.25X15-14	300X15-18
37		size, rear		7.00X12-12	7.00X12-12
38	Wheelbase		mm	2000	2000
39	Tread	front/rear (standard tire)	mm	1132/1115	1147/1115
40		loaded, at the lowest point	mm	160	160
41	Ground clearance	loaded, at center of wheelbase	mm	205	205
42	Brakes	service brake		foot/hydraulic	foot/hydraulic
43		parking brake		hand/mechanical	hand/mechanical
DRIVE					
45	Battery	voltage/capacity	v/ah	12/75	12/75
49	Engine	manufacturer/model		G643E(TIER- II)	G643E(TIER- II)
50		rated output (at rpm)	PS/rpm	95.9/2500	95.9/2500
51		max. torque	Kg.m/rpm	30.7/1400	30.7/1400
52		cycle/cylinders/displacement	cc	4/6/4294	4/6/4294
55	Gear shaft	type		powershift	powershift
56		no. speeds forward/reverse		2/2	2/2
57	Operating pressure	system/attachment	bar	190/140	190/140

DOOSAN	DOOSAN	1
G45S-2(TIER I)	G50C-2(TIER I)	2
4500	5000	3
600	600	4
LP-GAS	LP-GAS	5
rider - seated	rider - seated	6
p	p	7
X2/2	X2/2	8
3000	3050	9
155	160	10
		11
IV	IV	12
50 X 150 X 1200	60 X 150 X 1200	13
8'10	8'10	14
3190	3235	15
1445	1445	16
2230	2380	17
4420	4480	18
2230	2230	19
2865	2930	21
561	571	22
2021	2021	24
500/540	500/540	25
480/450	480/450	26
3410	3410	28
30.7	30.7	30
6560	7035	32
9860/1200	10585/1450	33
2725/3835	2660/4375	34
2/2	2/2	35
300X15-18	300X15-18	36
7.00X12-12	7.00X12-14	37
2000	2000	38
1147/1115	1147/1115	39
160	160	40
205	205	41
foot/hydraulic	foot/hydraulic	42
hand/mechanical	hand/mechanical	43
12/75	12/75	45
G643E(TIER-1)	G643E(TIER-1)	49
95.9/2500	95.9/2500	50
30.7/1400	30.7/1400	51
4/6/4294	4/6/4294	52
powershift	powershift	55
2/2	2/2	56
210/140	210/140	57

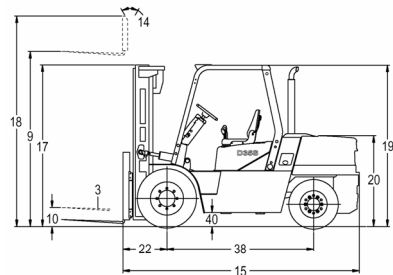
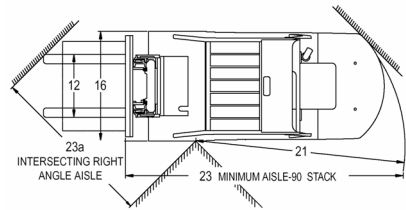

Specifications

CHARACTERISTICS						
1	Manufacturer		UNIT	DOOSAN	DOOSAN	DOOSAN
2	Model			D36S-2(TIER II)	D40S-2(TIER II)	D46S-2(TIER II)
3	Capacity	at rated load center	kg	3500	4000	4500
4	Load center	distance	mm	600	600	600
5	Power type	electric, diesel, gas, LP-GAS		diesel	diesel	diesel
6	Operator type	stand-on, rider seated		rider-seated	rider-seated	rider-seated
7	Tire type	c = cushion, p = pneumatic		p	p	p
8	Wheels (x = driven)	number, front/rear		X2/2	X2/2	X2/2
DIMENSIONS						
9	Lift with STD	maximum fork height with rated load	mm	3000	3000	3000
10	two - stage mast	free lift	mm	155	155	155
11		special free lift	mm			
12	Fork carriage	ISO class		II	II	IV
13	Forks	thickness X width X length	mm	50X150X1050	50X150X1050	50X150X1200
14	Tilt of mast	forward/backward	deg	8/10	8/10	8/10
15	Overall dimensions	length to fork face	mm	3075	3135	3190
16		width (standard tire)	mm	1365	1445	1445
17		mast lowered height	mm	2225	2230	2230
18		mast extended height	mm	4265	4270	4420
19		overhead guard height	mm	2225	2230	2230
20		seat height	mm			
21	Outside turning radius		mm	2770	2820	2865
22	Load moment constant (from center of front wheel to fork face)		mm	561	561	561
PERFORMANCE						
24	Speeds	traveling, loaded/unloaded	km/h	2425	2425	2425
25		lifting, loaded/unloaded	mm/s	520/540	520/540	520/540
26		lowering, loaded/unloaded	mm/s	480/450	480/450	480/450
28	Drawbar pull	at 1.6 km/h, loaded	kg	3300	3300	3400
30	Gradeability	at 1.6 km/h, loaded	%	38	35	32
31	Acceleration time	traveling, loaded/unloaded	s			
WEIGHT						
32	Total weight	unloaded	kg	5940	6170	6560
33	Axle load	at loaded, front/rear	kg	8340/1000	9050/1120	9660/1200
34		without loaded, front/rear	kg	2810/3030	2730/3440	2725/3835
CHASSIS						
36	Tires	number of front/rear		22	22	22
37		size, front		8.25X15-14	300X15-18	300X15-18
38		size, rear		7.00X12-12	7.00X12-12	7.00X12-12
39	Wheelbase		mm	2000	2000	2000
39	Tread	front/rear (standard tire)	mm	1132/1115	1147/1115	1147/1115
40	Ground clearance	loaded, at the lowest point	mm	160	160	160
41		loaded, at center of wheelbase	mm	205	205	205
42	Brakes	service brake		shoe/disc	shoe/disc	shoe/disc
43		parking brake		toggle	toggle	toggle
DRIVE						
45	Battery	voltage/capacity	V/AH	24/75	24/75	24/75
49	Engine	manufacturer/model		DOOSANDB68S	DOOSANDB68S	DOOSANDB68S
50		rated output (at rpm)	ps/rpm	92/2200	92/2200	92/2200
51		(DIN)	kW/hp	68/91	68/91	68/91
52		max. torque/rpm	kgm/rpm	31.5/1600	31.5/1600	31.5/1600
52		cycle/cylinders/displacement	cc	4/6/5/785	4/6/5/785	4/6/5/785
55	Transmission	type		powershift	powershift	powershift
56		no. speeds forward/reverse		22	22	22
57	Operating pressure	system/attachment	bar	190/140	190/140	210/140

DOOSAN	DOOSAN	DOOSAN	DOOSAN	
D40SC-2(TIER II)	D45SC-2(TIER II)	D50SC-2(TIER II)	D50C-2	1
4000	4500	5000	5000	2
500	500	500	600	3
diesel	diesel	diesel	diesel	4
rider - seated	rider - seated	rider - seated	rider - seated	5
p	p	p	p	6
X2/2	X2/2	X2/2	x2/2	7
3000	3000	3000	3050	8
155	155	155	160	10
				11
III	III	IV	IV	12
50 X 150 X 1050	50 X 150 X 1050	50 X 150 X 1200	60x150x1200	13
8/10	8/10	8/10	8/10	14
3075	3135	3190	3235	15
1365	1445	1445	1445	16
2225	2230	2230	2380	17
4265	4270	4420	4480	18
2225	2230	2230	2230	19
				20
2770	2820	2865	2930	21
561	561	561	571	22
2425	2425	2425	2425	24
520/540	520/540	510/540	510/540	25
480/450	480/450	490/450	490/450	26
3300	3300	3400	3500	28
36	33	32	30	30
				31
5840	6170	6560	7035	32
8930/910	9620/1050	10380/1180	10685/1450	33
2810/3030	2730/3440	2725/3830	2660/4375	34
22	2/2	2/2	2/2	35
8.25 X 15-14	300 X 15-18	300 X 15-18	300x15-18	36
7.00X 12-12	7.00X 12-12	7.00X 12-12	7.00x12-14	37
2000	2000	2000	2000	38
1132/1115	1147/1115	1147/1115	1147/1115	39
160	160	160	160	40
205	205	205	205	41
shoe/disc	shoe/disc	shoe/disc	shoe/disc	42
toggle	toggle	toggle	toggle	43
24/75	24/75	24/75	24/75	45
DOOSAN/DB58S	DOOSAN/DB58S	DOOSAN/DB58S	DOOSAN/DB58S	49
92/2200	92/2200	92/2200	92/2200	50
68/91	68/91	68/91	68/91	
33/1600	33/1600	33/1600	33/1600	51
4/6/5/7/85	4/6/5/7/85	4/6/5/7/85	4/6/5/7/85	52
Powershift	Powershift	Powershift	Powershift	53
2/2	2/2	2/2	2/2	56
190/140	210/140	210/140	210/140	57

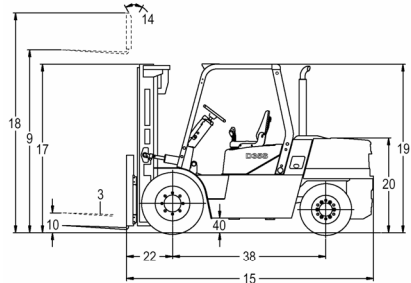
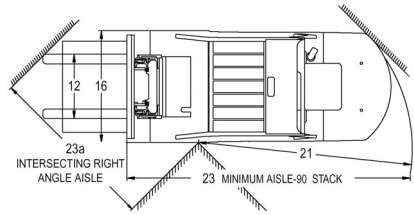

Noise and Vibration

Noise

Model		Noise Level [Unit : dB(A)]					Guaranteed Sound Power Level(L _{WA}) by new directive 2000/14/EC
		Sound Pressure Level at Operator's ear(Leq)		Sound Pressure Level at By-stander position (AS 3713)			
		AS3713	pEN12063	Drive-By	Lifting Mode		
D35/40/45S-2, D40/45/50SC-2, D50C-2 (TIER I E/G)	W/O Cabin	83.4	85.3	81	82	108	
	With Cabin	84.3	86.5	81	82	108	
D35/40/45S-2, D40/45/50SC-2, D50C-2 (TIER II E/G)	W/O Cabin	81.7	83.7	78.3	77.4	107	
G35/40/45S-2, G50C-2, G40/45/50SC-2, (W/O Cabin) (NON - CERT)		84.9	87.5	85	85	108	
G35/40/45S-2, G50C-2 (TIER II E/G) (W/O Cabin)		82.8	84.7	77.8	76.3	107	

Vibration(weighted overall value)

Unit : m/sec²

Model	Measuring place		
	Seat	Steering Wheel	Floor Plate
D35/40/45S-2, D40/45/50SC-2, D50C-2 (TIER I E/G)	1.02	0.97	1.06
D35/40/45S-2, D40/45/50SC-2, D50C-2 (TIER II E/G)	0.1	0.3	0.1
G35/40/45S-2, G50C-2, G40/45/50SC-2 (NON - CERT)	0.6	0.7	0.9
G35/40/45S-2, G50C-2 (TIER II E/G)	0.98	0.88	0.29

Capacity Chart

MODEL	SINGLE TIRE	SINGLE TIRE
	STD, FFL	FFT
D(G)40SC-2	<p>A. 3000, 3300, 3650, 4000mm MAST B. 4250mm MAST C. 4850mm MAST</p>	<p>A. 4000mm MAST B. 4250mm MAST C. 4700mm MAST D. 5150mm MAST E. 5600mm MAST F. 6050mm MAST</p>
	<p>A. 3000, 3300, 3650, 4000, 4250mm MAST B. 4850mm MAST</p>	<p>A. 4000, 4250mm MAST B. 4700mm MAST C. 5150mm MAST D. 5600mm MAST E. 6050mm MAST</p>
D(G)50SC-2	<p>A. 3000, 3300, 3650mm MAST B. 4000mm MAST C. 4250mm MAST D. 4850mm MAST</p>	<p>A. 4000mm MAST B. 4250mm MAST C. 4700mm MAST D. 5100mm MAST E. 5600mm MAST F. 6050mm MAST</p>

IA3M2001

Capacity Chart

MODEL	DOUBLE TIRE	DOUBLE TIRE
	STD, FFL	FFT
D(G)40SC-2	<p>A. 3000, 3300, 3650, 4000mm MAST B. 4250mm MAST C. 4850mm MAST</p>	<p>A. 4000mm MAST B. 4250mm MAST C. 4700mm MAST D. 5150mm MAST E. 5600mm MAST F. 6050mm MAST</p>
	<p>A. 3000, 3300, 3650, 4000, 4250mm MAST B. 4850mm MAST</p>	<p>A. 4000mm MAST B. 4520mm MAST C. 4700mm MAST D. 5150mm MAST E. 5600mm MAST F. 6050mm MAST</p>
D(G)50SC-2	<p>A. 3000, 3300, 3650mm MAST B. 4000mm MAST C. 4250mm MAST D. 4850mm MAST</p>	<p>A. 4000mm MAST B. 4250mm MAST C. 4700mm MAST D. 5150mm MAST E. 5600mm MAST F. 6050mm MAST</p>

IA3M2002

Capacity Chart (with Side Shifter)

MODEL	SINGLE TIRE	SINGLE TIRE
	STD, FFL	FFT
D(G)40SC-2	<p>A. 3000, 3300, 3650, 4000mm MAST B. 4250mm MAST C. 4850mm MAST</p>	<p>A. 4000mm MAST B. 4250mm MAST C. 4500mm MAST D. 5150mm MAST E. 5600mm MAST F. 6050mm MAST</p>
D(G)45SC-2	<p>A. 3000, 3300, 3650, 4000, 4250mm MAST B. 4850mm MAST</p>	<p>A. 4000, 4250mm MAST B. 4700mm MAST C. 5150mm MAST D. 5600mm MAST E. 6050mm MAST</p>
D(G)50SC-2	<p>A. 3000, 3300, 3650mm MAST B. 4000mm MAST C. 4250mm MAST D. 4850mm MAST</p>	<p>A. 4000mm MAST B. 4250mm MAST C. 4700mm MAST D. 5100mm MAST E. 5600mm MAST F. 6050mm MAST</p>

IA3M2003

Capacity Chart (with Side Shifter)

MODEL	DOUBLE TIRE	DOUBLE TIRE
	STD, FFL	FFT
D(G)40SC-2	<p>A. 3000, 3300, 3650, 4000mm MAST B. 4250mm MAST C. 4850mm MAST</p>	<p>A. 4000mm MAST B. 4250mm MAST C. 4700mm MAST D. 5150mm MAST E. 5600mm MAST F. 6050mm MAST</p>
	<p>A. 3000, 3300, 3650, 4000, 4250mm MAST B. 4850mm MAST</p>	<p>A. 4000mm MAST B. 4520mm MAST C. 4700mm MAST D. 5150mm MAST E. 5600mm MAST F. 6050mm MAST</p>
D(G)50SC-2	<p>A. 3000, 3300, 3650mm MAST B. 4000mm MAST C. 4250mm MAST D. 4850mm MAST</p>	<p>A. 4000mm MAST B. 4250mm MAST C. 4700mm MAST D. 5150mm MAST E. 5600mm MAST F. 6050mm MAST</p>

IA3M2004

Capacity Chart

MODEL	SINGLE TIRE	SINGLE TIRE
	STD, FFL	FFT
D(G)35S-2	<p>A. 3000, 3300, 3660, 4000, 4250mm MAST B. 4850mm MAST</p>	<p>A. 4000, 4250mm MAST E. 6050mm MAST B. 4700mm MAST C. 5150mm MAST D. 5600mm MAST</p>
	<p>A. 3000, 3300, 3660, 4000, 4250, 4850mm MAST</p>	<p>A. 4000, 4250mm MAST E. 6050mm MAST B. 4700mm MAST C. 5150mm MAST D. 5600mm MAST</p>
D(G)45S-2	<p>A. 3000, 3300, 3660mm MAST B. 4000mm MAST C. 4250mm MAST D. 4850mm MAST</p>	<p>A. 4000mm MAST E. 5600mm MAST B. 4250mm MAST F. 6050mm MAST C. 4700mm MAST D. 5100mm MAST</p>

IA3M2005

Capacity Chart

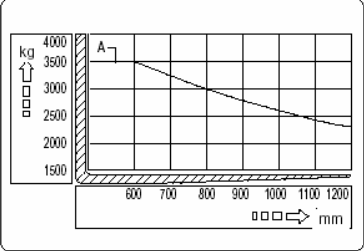
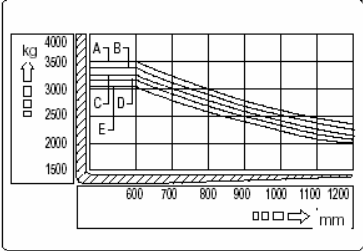
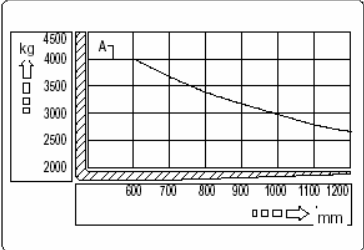
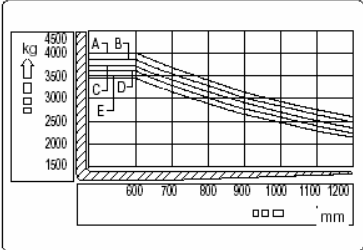
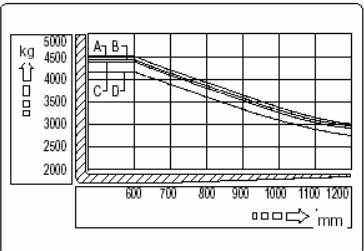
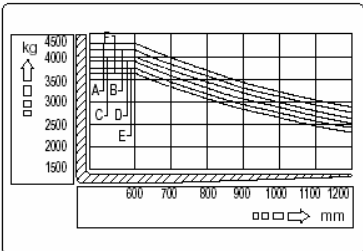
MODEL	DOUBLE TIRE	DOUBLE TIRE
	STD, FFL	FFT
D(G)35S-2	 <p>A. 3000, 3300, 3650, 4000, 4250, 4850mm MAST</p>	 <p>A. 4000, 4250mm MAST E. 6050mm MAST B. 4700mm MAST C. 5150mm MAST D. 5600mm MAST</p>
	 <p>A. 3000, 3300, 3650, 4000, 4250, 4850mm MAST</p>	 <p>A. 4000, 4250mm MAST E. 6050mm MAST B. 4700mm MAST C. 5150mm MAST D. 5600mm MAST</p>
D(G)45S-2	 <p>A. 3000, 3300, 3650mm MAST B. 4000mm MAST C. 4250mm MAST D. 4850mm MAST</p>	 <p>A. 4000mm MAST E. 5600mm MAST B. 4250mm MAST F. 6050mm MAST C. 4700mm MAST D. 5150mm MAST</p>

IA3M2006

Capacity Chart (with Side Shifter)

MODEL	SINGLE TIRE	SINGLE TIRE
	STD, FFL	FFT
D(G)35S-2	<p>A. 3000, 3300, 3650, 4000mm MAST B. 4250mm MAST C. 4850mm MAST</p>	<p>A. 4000mm MAST B. 4250mm MAST C. 4700mm MAST D. 5150mm MAST E. 5600mm MAST F. 6050mm MAST</p>
	<p>A. 3000, 3300, 3650, 4000, 4250mm MAST B. 4850mm MAST</p>	<p>A. 4000, 4250mm MAST B. 4700mm MAST C. 5150mm MAST D. 5600mm MAST E. 6050mm MAST</p>
D(G)45S-2	<p>A. 3000, 3300, 3650mm MAST B. 4000mm MAST C. 4250mm MAST D. 4850mm MAST</p>	<p>A. 4000mm MAST B. 4250mm MAST C. 4700mm MAST D. 5100mm MAST E. 5600mm MAST F. 6050mm MAST</p>

IA3M2007

Capacity Chart (with Side Shifter)

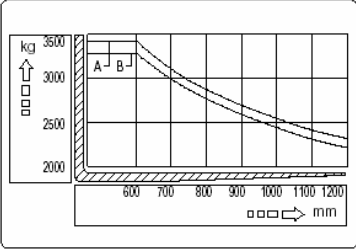
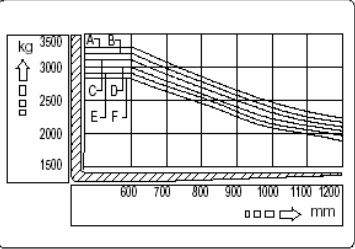
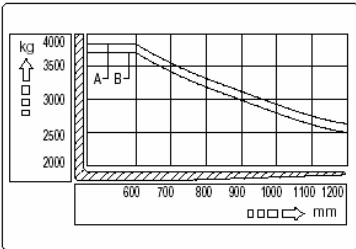
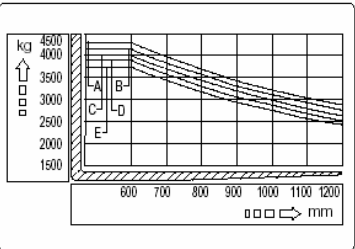
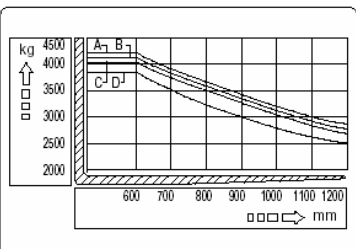
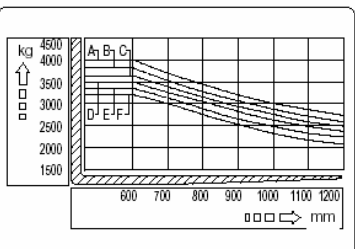
MODEL	DOUBLE TIRE	DOUBLE TIRE
	STD, FFL	FFT
D(G)35S-2	 <p>A. 3000, 3300, 3650, 4000, 4250mm MAST B. 3450mm MAST</p>	 <p>A. 4000mm MAST E. 5600mm MAST B. 4250mm MAST F. 6050mm MAST C. 4700mm MAST D. 5150mm MAST</p>
	 <p>A. 3000, 3300, 3650, 4000, 4250mm MAST B. 3450mm MAST</p>	 <p>A. 4000, 4250mm MAST E. 6050mm MAST B. 4700mm MAST C. 5150mm MAST D. 5600mm MAST</p>
D(G)45S-2	 <p>A. 3000, 3300, 3650mm MAST B. 4000mm MAST C. 4250mm MAST D. 4850mm MAST</p>	 <p>A. 4000mm MAST E. 5600mm MAST B. 4250mm MAST F. 6050mm MAST C. 4700mm MAST D. 5150mm MAST</p>

IA3M2014

Capacity Chart

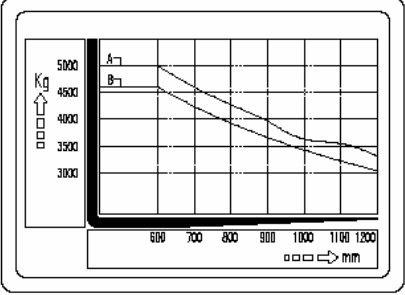
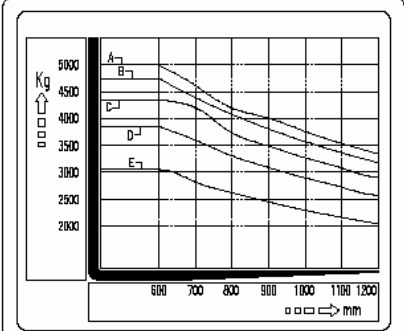
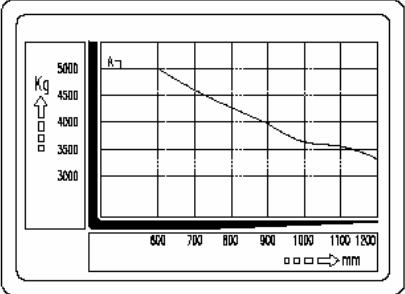
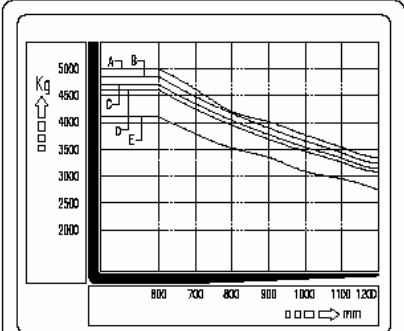
MODEL	SINGLE TIRE STD, FFL	SINGLE TIRE FFT
D(G)50C-2	 <p data-bbox="188 639 437 675">A. 2750, 3050, 3400, 3850, 4000mm MAST B. 4600mm MAST</p>	 <p data-bbox="608 679 932 735">A. 3875, 4125mm MAST D. 5475mm MAST B. 4575mm MAST E. 5925mm MAST C. 5025mm MAST</p>
	DOUBLE TIRE STD, FFL	DOUBLE TIRE FFT
	 <p data-bbox="188 1185 471 1206">A. 2750, 3050, 3400, 3850, 4000, 4600mm MAST</p>	 <p data-bbox="608 1230 888 1286">A. 3875, 4125mm MAST D. 5475mm MAST B. 4575mm MAST E. 5925mm MAST C. 5025mm MAST</p>

Capacity Chart (with Side Shifter)

MODEL	SINGLE TIRE	SINGLE TIRE
	STD, FFL	FFT
D(G)50C-2		
	<p>A. 2750, 3050, 3400, 3850, 4000, 2875mm MAST B. 4600mm MAST</p>	<p>A. 3875, 4125mm MAST D. 5475mm MAST B. 4575mm MAST E. 5925mm MAST C. 5025mm MAST</p>
	DOUBLE TIRE	DOUBLE TIRE
	STD, FFL	FFT
<p>A. 2750, 3050, 3400, 3750, 4000, 2875mm MAST B. 4600mm MAST</p>	<p>A. 3875, 4125mm MAST D. 5475mm MAST B. 4575mm MAST E. 5925mm MAST C. 5025mm MAST</p>	

Serial Number

Serial Number Locations

For quick reference, record your lift truck's serial numbers in the spaces provided below the photographs.



Lift Truck Serial Number

• _____

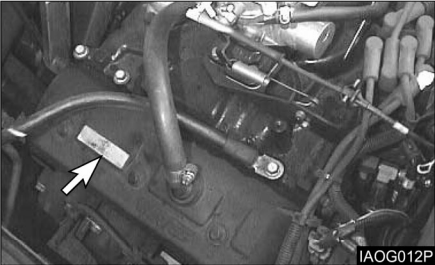

4.3 liter GM Vortec Engine Serial Number(G643)

• _____



4.3 liter GM Vortec Engine Serial Number(G643E)

• _____

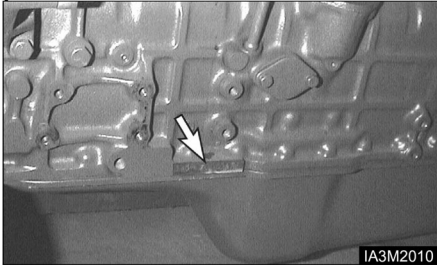

5.8 liter Diesel Engine(TIER I) Serial Number

• _____

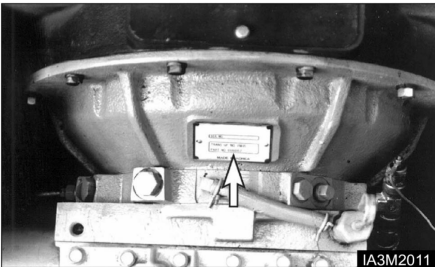

Transmission Serial Number

• _____

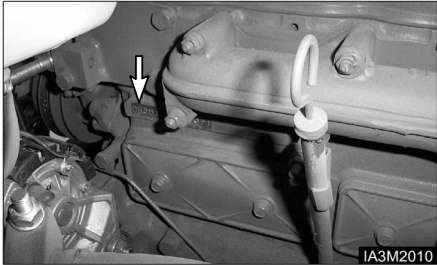

5.8 liter Diesel Engine(TIER II)Serial Number

• _____

General Section

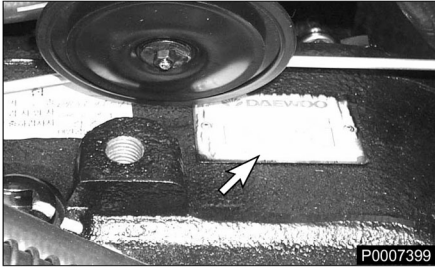

DRIVE AXLE Serial Number

• _____

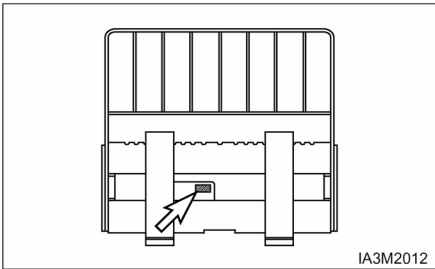

Side Shifter Serial Number(If Equipped)

• _____

Operator's Warning and Identification Plate

Familiarize yourself with the OPERATOR'S WARNING Plate, and IDENTIFICATION, LIFT CAPACITY and ATTACHMENT PLATES. DO NOT exceed capacity as equipped load ratings

Operator's Warning Plate



Located on the cowl to the right side of the steering column.

Identification, Lift Capacity and Attachment Plate

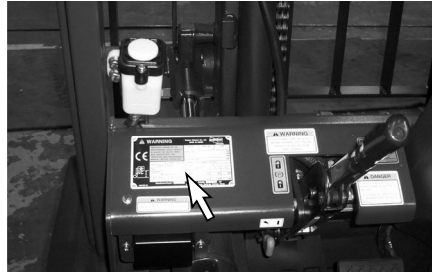

Located on the cowl to the right side of the steering column.

Lift Truck Capacity Rating

DO NOT exceed allowable lift truck working capacity load ratings.

The capacity of the lift truck is given by weight and distance to the load center. For example, a capacity of 1200kg (2640lb) at 600mm (24in) means that the lift truck can lift 1200kg (2640lb) if the load center is 600 mm (24in) from both the vertical and horizontal faces of the forks.

Before attempting to lift any load, ensure that the weight and load center combination is within the capacity of the lift truck as shown on the capacity rating plate. To determine the load center, measure the distance from the face of the carriage to the gravitational center of the load.

The rated capacity on the plate refers to the capacity of the lift truck as it left the factory. Subsequent changes of any form to the equipment or battery can alter the lift truck's rating.

The rated capacity of the lift truck applies to operating conditions where the lift truck is on level ground. The capacity of the lift truck is reduced on inclines.

Below are abbreviations that may appear on the Identification, Lift Capacity and Attachment Plate and their meanings.

Mast Abbreviations

STD - Standard Mast (single inner member, low free lift)

FF - Full Free Lift Mast (single inner member with high free lift duplex cylinder)

FFT - Triple Lift Mast (two inner members) with either low or full free lift characteristics.

QUAD - Quadruple (Quad) Mast (with three inner members)

NOTE : When only a mast-type is listed on the identification plate, a standard carriage and forks are used.

Attachment Abbreviations (Includes Special Forks)

SC - Special Carriage-increased width, height or outreach

SSS - Shaft-type Sideshift Carriage

HSS - Hook-type Sideshift Carriage (ITA)

CW - Counterweight

SF - Special Forks

SWS - Swing Shift, Sideshift

RAM - Ram or Boom

DBCBH - Double Cube Block Handler

HFP - Hydraulic Fork Positioner

CR - Crane Arm or Crane Boom

TH - Tire Handler

CTH - Container Handler

LPP - Load Push-Pull Device

CC - Carton Clamp

RC - Roll Clamp

LS - Load Stabilizer

PWH - Pulp Wood Handler

SS-ST - Sideshift-Side Tilt Carriage

Operator's Station and Monitoring Systems

Instrument Panel

Your lift truck may not have the same indicator or warning lights as shown in the illustrations. Due to the various options available, typical instrument panels are shown.

However, the symbols on the indicators and lights on your panel identify what those particular items are.

Also, the symbol for each of the items is identified and an explanation of their function and location is described on the following pages.

Diesel (24V)

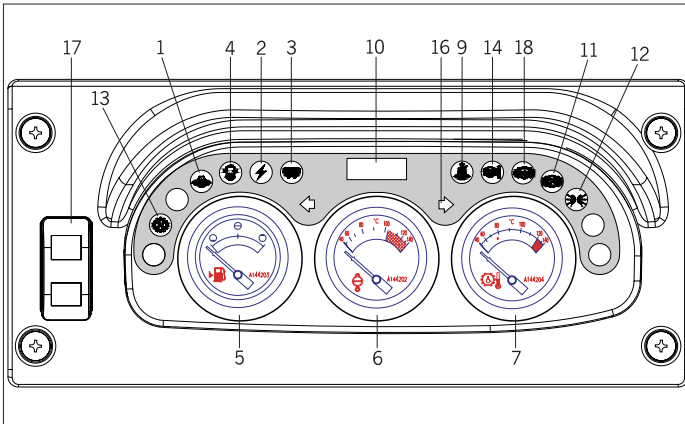

LPG (12V) – LED Type

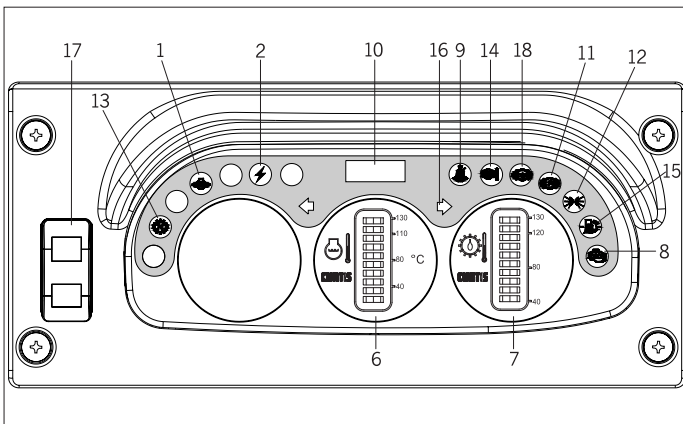



1. Engine Oil Pressure Indicator Light - Indicates insufficient engine oil pressure. The light will come on when the ignition switch is turned to the ON position. The light should go off after the engine is started. If the light turns on while operating the lift trucks, insufficient engine oil pressure is indicated. Park the lift truck and stop the engine.



2. Alternator Indicator Light - Indicates if the battery charging system is operational. The light will come on when the ignition switch is turned to the ON position.

The light should go off after the engine is started, indicating the alternator is producing sufficient voltage to charge the battery. If the light turns on with the engine running, check the alternator charging system for a malfunction.



3. Diesel Engine Start Preheat Indicator Light - The light will come ON when the key is turned to the ON position from the OFF position. This indicates that the glow plugs are preheating the pre-combustion chambers for easier starting.

The amount of time needed to preheat the pre-combustion chambers is approximately seven seconds, depending on the surrounding air temperature. When the light goes OFF the maximum pre-combustion chamber temperature has been reached and the key can be turned to the START position to start the engine.



4. Diesel Engine Water in Fuel Indicator Light (If Equipped) - Indicates when the engine is running, there is water in the fuel filter exceeds 100cc.

The light will come ON when the ignition switch is turned to the ON position. The light should go off after the engine is started. If the light turns on with the engine running, park the lift truck and stop the engine.

Drain some fuel (and any water) until clean fuel flows from the filter which approximately takes 5 to 6 seconds.



5. Fuel Level Gauge - Indicates fuel level (Gas, Diesel, or Dual Fuel Trucks Only).



6. Engine Coolant Temperature Gauge - Indicates coolant temperature. If the pointer moves beyond the green band while operating the lift truck, overheating is indicated. Park the lift truck and stop the engine.

Check the cooling system for a malfunction. The pointer will be at the end of the green band when the coolant temperature reaches approximately 106°C (223°F) on all engines.

(LED Type Gage) If both tenth & ninth flash out of phase while operating the lift truck, overheating is indicated. Park the lift truck and stop the engine.

Check the cooling system for a malfunction. Both tenth

& ninth will flash out of phase when the coolant temperature reaches approximately 106°C (223°F) on all engine.



7. Transmission Oil Temperature Gauge - Indicates transmission oil temperature. If the pointer moves beyond the green band while operating the lift truck, excessive transmission oil temperature is indicated. Park the lift truck and stop the engine.

(LED Type Gage) If both tenth & ninth flash out of phase while operating the lift truck, excessive transmission oil temperature is indicated. Park the lift truck and stop the engine.



8. G643E Engine Malfunction Indicator Lamp (MIL) - G643E engine control system are equipped with built-in fault diagnostics.

Detected system faults can be displayed by the Malfunction Indicator Lamp (MIL) as Diagnostic Faults Codes (DFC) or flash codes, and viewed in detail with the use of service tool software. When the ignition key is turned ON the MIL will perform a self-test, illuminate once and then go OFF. If a detected fault condition exists, the fault or faults will be stored in the memory of the engine control module (ECM). Once a fault occurs the MIL will illuminate and remain ON. This signals the operator that a faults has been detected by the SECM.



9. Seat Belt Warning Light (If Equipment) - Indicates when the seat belt does not fastened by operator.

The light will come on when the ignition switch is turned to the on position. The light should go off after engine is started.



10. Service Hour Meter - Indicates the total number of hours the engine and the lift truck have operated. The hour meter will operate when the ignition switch is in the ON position, whether the engine is running or not. The hour meter is used to determine lubrication and maintenance intervals.



11. Parking indicator light- The light will come ON when the parking lever is applied.



12. Front Floodlights- Push down on the switch(17), to the first step, to turn the front floodlights on.

Front and Rear Floodlights - Push down on the switch(17), to the second step, to turn both the front and rear floodlights on. The floodlights are optional.



13. Transmission Neutral Position Light - Indicates the neutral position of transmission.



14. Drive Axle Oil Indicator Light (OCDB only) - Indicates too hot drive axle oil. The light will be ON when the ignition switch is in the ON position and must go OFF when the engine is running.

Do not continue to operate the lift truck if the light is ON during operation.



15. Low Level Light of LP GAS – Indicates the low Level of LP GAS (LP only) (if Equipped)

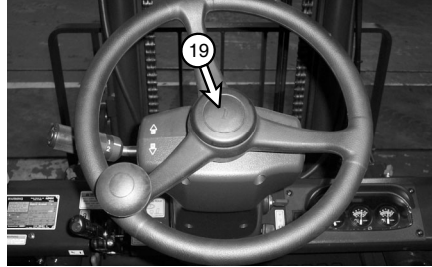

19. Horn Switch - Push on the horn button to sound the horn.



16. Directional Turning Indicator Light



17. Front and Rear Floodlights Switch – The front floodlight is ON when push down switch to the first step.

The front and rear floodlights are ON when push down switch to the second step.



18. Brake Fluid Oil Light (if Equipped) – The light is ON when the brake fluid oil of brake reservoir comes down to low level position. Refill the proper brake fluid oil if its light is ON.

⚠ WARNING

Frequent rapid starts at 2nd speed can be the cause of overheating at torque converter. With this operating condition, the pointer can sometimes exceed the green band. If this situation occurs from time to time, please avoid this operating condition to protect the transmission and increase the work efficiency. That is, start the truck at 1st speed and shift to 2nd speed to increase the travel speed.

Engine Compartment

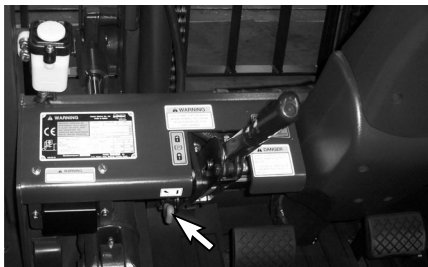

1. The engine compartment is accessible by pulling the latch and raising the hood and seat assembly.

NOTE: Unlock latch before pulling if key equipped.



2. The hood and seat assembly is held up by a support cylinder. Make certain the air cylinder is operating properly and securely holds the hood up before doing anything in the engine compartment.

Circuit Breaker

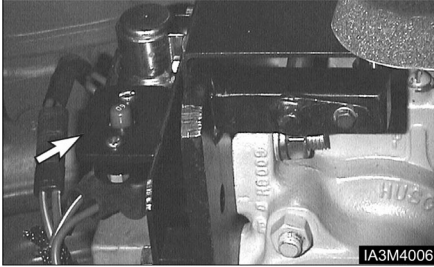

Typical Example

Diesel Engine Truck

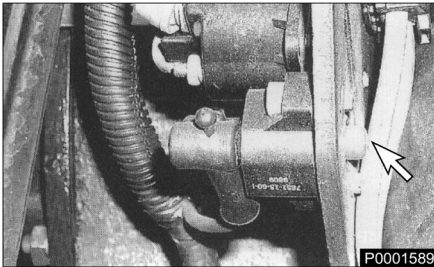

Typical Example

LP-Gas Engine Truck



Circuit Breaker - Protects the main electrical circuits. To reset the circuit breaker, push the button in. Located in the engine compartment.

Tilt Steering Column

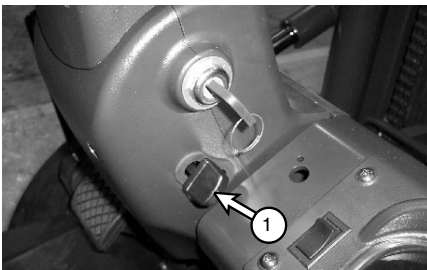

To adjust the steering column, push down the knob(1), and move the steering column to the desired position, then release the knob(1).

Electrical Disconnect Switch (If Equipped)

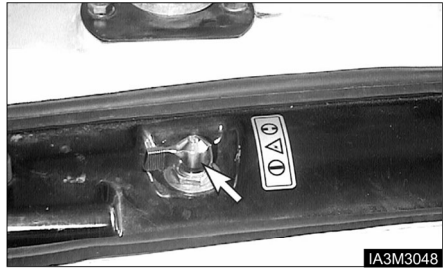

1. ON-Connects the battery for electrical power to all electrical circuits.



2. OFF-Disconnects the battery from all electrical circuits.

Seat

NOTE: Seat arrangements may vary. Basic operation will be similar.

Seat adjustment should be checked at the beginning of each shift and when operators change.

Lock the seat into position before operating, to prevent an unexpected seat change.

Adjust seat to allow full brake pedal travel with operator's back against seat back.



NOTE: The seat can only be correctly adjusted with the operator fully seated.

Seat Switch System (If Equipped)



The lift truck is equipped with a SEAT SWITCH SYSTEM. In normal operation if the direction lever is placed in either forward or reverse, the lift truck will move at a speed proportional to the accelerator pedal's position. If the operator leaves the seat without setting the parking brake, within three seconds after leaving the seat, the SEAT SWITCH SYSTEM will automatically disengage the transmission. The directional lever, however, will remain in that forward or reverse location although internally the transmission will have shifted into neutral.

Before exiting the lift truck, the parking brake should always be applied.

WARNING

WHEN LEAVING MACHINE APPLY PARKING BRAKE!

PARKING BRAKE IS NOT AUTOMATICALLY APPLIED.

NOTE: Some trucks may be equipped (ask your dealer if this applies to your truck) with an alarm that will sound if the parking brake is not applied when leaving the machine.

NOTICE

1. Prior to operating the lift truck, be sure to understand and check the SEAT SWITCH SYSTEM.
 2. While in normal operation and on level ground, select a direction with the directional lever and with the park brake released. You will note that the truck will move slowly in the selected direction. If you lift your hips off of the seat, within three seconds, the SEAT SWITCH SYSTEM will disengage the transmission allowing the truck to coast but not automatically stop.
 3. To restore the lift truck to normal operation, while sitting in the operator's seat depress the brake pedal to hold the lift truck, return the directional lever to the neutral position, and then reselect a direction of travel (either forward or reverse). The transmission will then re-engage.
 4. If seat or seat switch replacement becomes necessary, be sure to use genuine DOOSAN Infracore lift truck parts. Lift trucks should never be operated without an operational SEAT SWITCH SYSTEM.
-

Lift Truck Controls

Direction Control Lever



1. Forward - Push the lever forward for FORWARD direction travel.



2. Neutral - Move the lever to center position for NEUTRAL.



3. Reverse - Pull the lever back for REVERSE direction travel.

Transmission Speed Range Lever



1. High - Rotate the lever counterclockwise for HIGH speed range.

2. Low - Rotate the lever clockwise for LOW speed range.

Transmission Inching Control Pedal

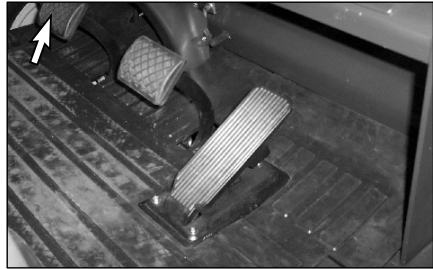



Inching Control Pedal - Pushing down on the inching pedal, modulates the hydraulic pressure to the clutch packs, permitting disc slippage.

Further pushing on the pedal completely relieves clutch pack pressure and applies the service brakes to stop and hold the lift truck.

NOTE: The purpose of the inching control pedal is to provide precise inching control at slow travel speed, with high engine rpm. This is used for fast hydraulic lift during load approach, pickup or positioning.

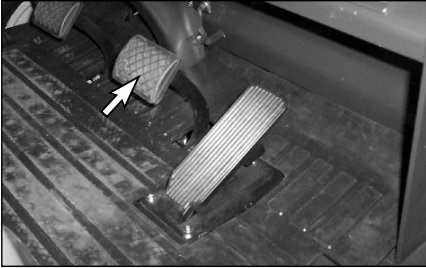

Service Brake Pedal



-  **Push DOWN** on the brake pedal to slow or stop the lift truck.
-  **RELEASE** the brake pedal to allow the lift truck to move.



Parking Brake Lever

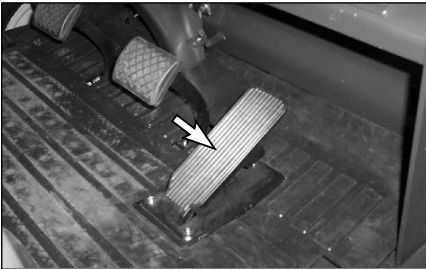

-  Pull the lever **BACK** to engage the parking brake.
-  Push the lever **FORWARD** to release the parking brake.

Accelerator Pedal



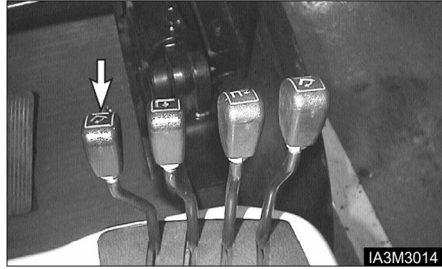

-  **Push DOWN** on the pedal to increase engine rpm (speed).
-  **RELEASE** the pedal to decrease engine rpm (speed).

Lift Control



NOTE: To prevent a sudden change of position of the load, operate all lift, tilt and attachment controls smoothly.

-  **1. Lower Position** - Push the lever **FORWARD** smoothly to lower the load.
-  **2. Hold Position** - When the lever is released it will return to the **HOLD** or center position. Lifting or lowering action will stop.
-  **3. Lift Position** - Pull the lever **BACK** smoothly to lift the load.

Tilt Control

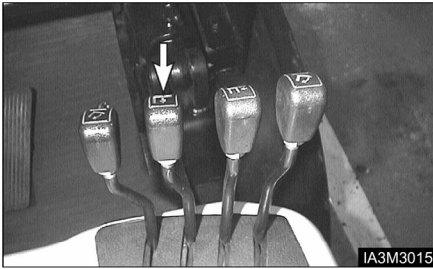

IA3M3015

1. **Mast Tilt Forward** - Push the lever FORWARD smoothly to tilt the mast forward.
2. **Mast Hold** - When the lever is released it will return to the HOLD or center position. Tilting action will stop.
3. **Mast Tilt Back** - Pull the lever BACK smoothly to tilt the mast backward.

Sideshift Attachment Control (If Equipped)

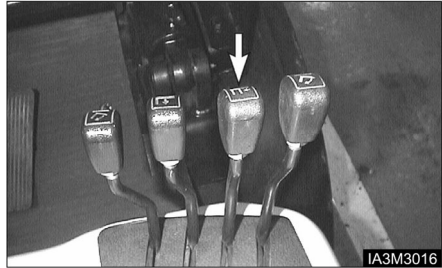

IA3M3016

1. **Sideshift Left** - Push the lever FORWARD to shift the carriage to the left.
2. **Sideshift Hold** - When the lever is released it will return to the HOLD or center position. Sideshifting action will stop.
3. **Sideshift Right** - Pull the lever BACK to shift the carriage to the right.

Refueling

Diesel Engine Equipped

⚠ WARNING

Explosive fumes may be present during refueling.

Do not smoke in refueling areas.

Lift truck should be refueled only at designated safe locations. Safe outdoor locations are preferable to those indoors.

Stop the engine and get off the lift truck during refueling.

NOTICE

Do not allow the lift truck to become low on fuel or completely run out of fuel. Sediment or other impurities in the fuel tank could be drawn into the fuel system. This could result in difficult starting or damage to components.

Fill the fuel tank at the end of each day of operation to drive out moisture laden air and to prevent condensation. In the cold weather, the moisture condensation can cause rust in the fuel system and hard starting due to its freezing. Do not fill the tank to the top. Fuel expands when it gets warm and may overflow.



1. Park the lift truck only at a designated safe location. Place the transmission in NEUTRAL. Lower the forks to the ground. Engage the parking brake. Stop the engine.



2. Remove the filter cap.
3. Fill the fuel tank slowly. Install the filter cap. If spillage occurs, wipe off excess fuel and wash down area with water.

NOTE: Drain water and sediment from fuel tank as required by prevailing conditions. Also, drain water and sediment from the main fuel storage tank weekly and before the tank is refilled. This will help prevent water or sediment being pumped from the storage tank into the lift truck fuel tank.

Changing LP-Gas Tanks

WARNING

Only trained, authorized personnel should fill or exchange LP-Gas tanks.

Personnel engaged in filling of LP-Gas containers should wear protective clothing such as face shield, long sleeves and gauntlet gloves.

Do not refuel or store LP-Gas powered lift trucks near any underground entrance, elevator shafts or any other place where LP-Gas could collect in a pocket causing a potentially dangerous condition.

Examine all LP-Gas containers before filling and again before reuse, for damage to various valves, liquid gauge, fittings and hand valve wheels.

All defective or damaged LP-Gas containers must be removed from service.

Explosive fumes may be present during refueling.

Do not smoke in refueling areas.

Lift truck should be refueled only at designated safe locations. Safe outdoor locations are preferable to indoor locations.

Stop the engine and get off the lift truck during refueling.

The careless handling of LP-Gas containers can result in a serious accident.

Use extreme care when transporting containers to prevent damage to them.

1. Park the lift truck on level ground, with the parking brake applied, the transmission in NEUTRAL, the forks lowered and the engine running at low idle.

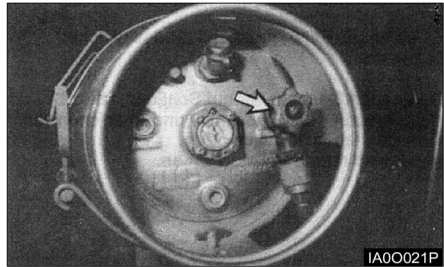

2. Close the fuel inlet valve at the LP - Gas tank. Run the engine until it stops, then turn off the ignition switch and the electrical disconnect switch (if equipped).
3. Disconnect the fuel supply line.

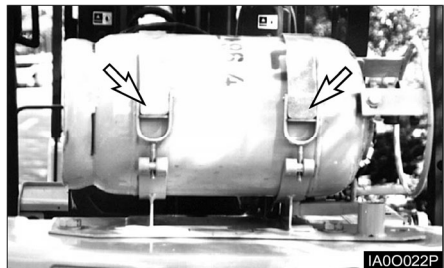

4. Loosen the retaining clamps and remove the tank.
5. Check the mounting to be sure the locating pin (dowel) is not missing or broken.

NOTICE

If the location pin (dowel) is missing or broken, be sure the pin is replaced.

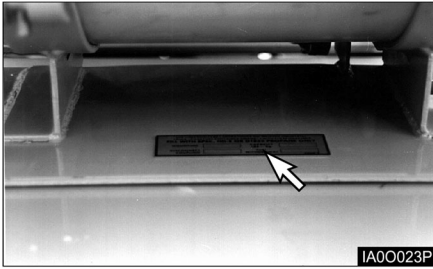

6. Check to be sure that the LP-Gas warning plate is in position on the lift truck, and is legible.
7. Check to be sure the replacement tank is of the correct type.
8. Inspect the replacement tank for damage such as dents, scrapes or gouges and for indication of leakage at valves or threaded connections.

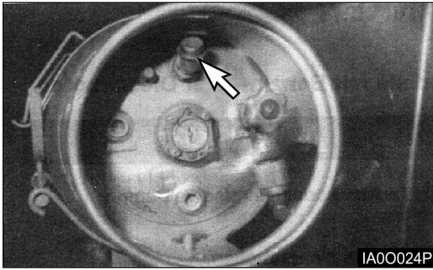

9. Check for debris in the relief valve, for damage to various valves and liquid level gauge.
10. Inspect the quick-disconnect couplings for deterioration, damage or missing flexible seals.

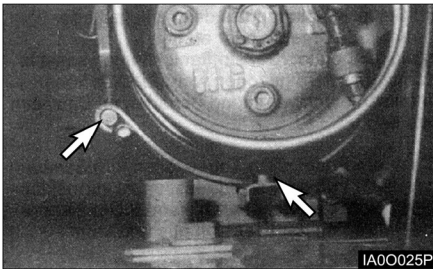

11. Position the replacement tank so that the locating pin (dowel) is in place.

⚠ WARNING

The LP-Gas tank must not extend past the counterweight.

12. Clamp the tank securely.
13. Connect the fuel supply line.
14. Open the fuel valve by slowly turning the valve counterclockwise. If the fuel valve is opened too quickly, a back pressure check valve will shut off the fuel supply. If this happens, close the fuel valve completely. Wait five seconds and then open the fuel valve very slowly.
15. Inspect the LP-Gas fuel lines and fittings with a soap solution after filling the tank or when looking for leaks.

Before Starting the Engine

Walk-Around Inspection

Make a thorough walk-around inspection before mounting the lift truck or starting the engine. Look for such items as loose bolts, debris buildup, oil or coolant leaks. Check condition of tires, mast, carriage, forks or attachments. Have repairs made as needed and all debris removed.



1. Inspect the operator's compartment for loose items and cleanliness.
2. Inspect the instrument panel for broken or damaged indicator lights or gauges.
3. Test the horn and other safety devices for proper operation.

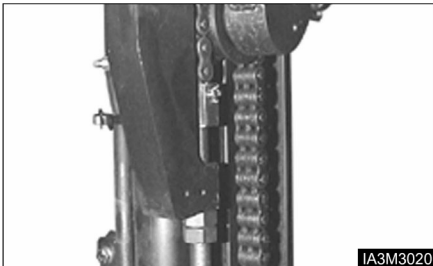

4. Inspect the mast and lift chains for wear, broken links, pins and loose rollers.
5. Inspect the carriage, forks or attachments for wear, damage and loose or missing bolts.
6. Inspect the tires and wheels for cuts, gouges, foreign objects, inflation pressure and loose or missing bolts.

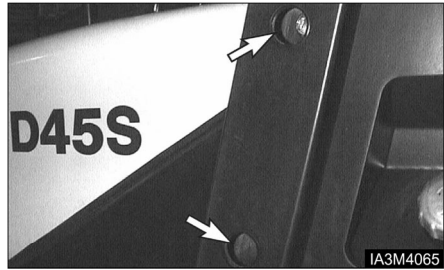

7. Inspect the overhead guard for damage and loose or missing mounting bolts.
8. Inspect the hydraulic system for leaks, worn hoses or damaged lines.
9. Look for transmission and drive axle leaks on the lift truck and on the ground.



Typical Example

TIER I Diesel Engine Truck

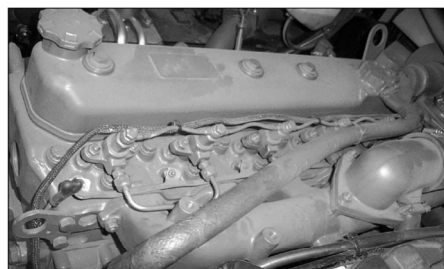

Typical Example

TIER II Diesel Engine Truck

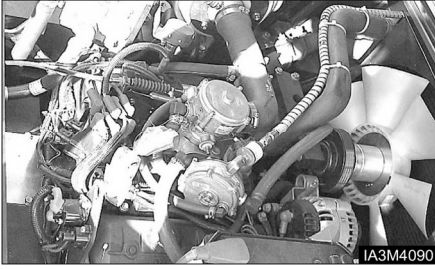

Typical Example

LP-Gas Engine Truck

- 10. Inspect the engine compartment for oil, coolant and fuel leaks.

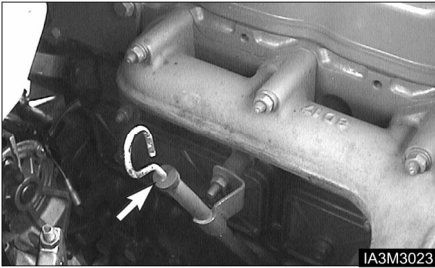

- 11. Measure the engine crankcase oil level with the dip stick. Maintain the oil level between the MAX. and MIN., (or FULL and ADD) notches on the dip stick.

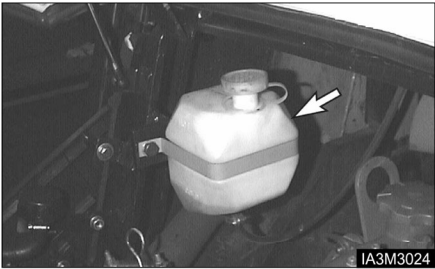

- 12. Observe the engine coolant level in the coolant recovery bottle. With the engine cold, maintain the level to the COLD mark. If the recovery bottle is empty, also fill the radiator at the top tank.

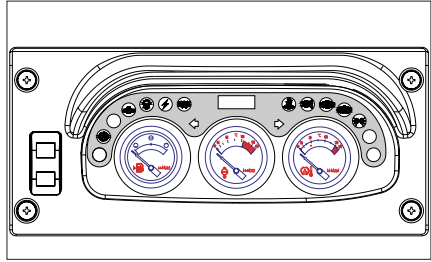

- 13. Observe the fuel level gauge after starting the truck. Add fuel if necessary
- 14. In case of LPG truck, if needed, change LPG Fuel Tank as the procedure of changing LP-Gas tanks in Refueling Section.

▲ WARNING

Personal injury may occur from accidents caused by improper seat adjustment. Always adjust the operator's seat before starting the lift truck engine.

Seat adjustment must be done at the beginning of each shift and when operators change.



- 15. To position the seat, PUSH the lever away from the seat track and move the seat forward or backward to a comfortable position.

Starting the Engine

Prestart Conditions

NOTE: The engine will not start unless the transmission directional control lever is in the NEUTRAL position.



1. Engage the parking brake, if not already engaged. Place the transmission directional control lever in the NEUTRAL position.

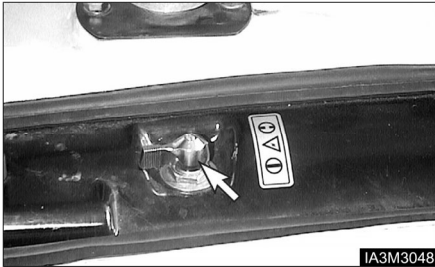

2. If lift trucks are equipped with electrical disconnect switches, the engine will not start unless the disconnect switch is in the ON (closed) position. Before starting, turn the disconnect switch to the OFF(open) position.

Diesel Engine

Starting a Cold Diesel Engine

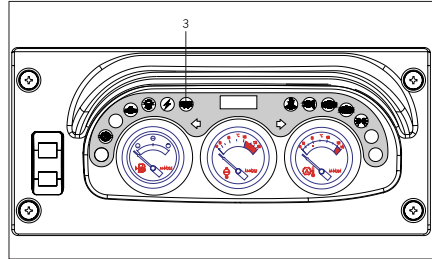

1. Turn the key to the ON position. The start preheat indicator light will come ON. The preheat indicator light will stay ON approximately seven seconds, depending on the surrounding air temperature.

NOTICE

Do not engage the starter for more than 10 seconds.

2. When the preheat indicator light goes OFF, turn the key to the START position, with the accelerator pedal fully depressed.
3. Release the key when the engine starts and release the accelerator pedal to a low idle position.
4. If the engine stalls or does not start, turn the key to the OFF position, then repeat steps 1 thru 3.

Starting a Warm Diesel Engine

1. Turn the key to the ON position and then to START position, without waiting for the preheat indicator light to go OFF. At the same time fully depress the accelerator.
2. Release the key when the engine starts and release the accelerator pedal to a low idle position.

LP-Gas Engine

⚠ WARNING

LP - Gas fuel is flammable and can cause personal injury.

Inspect LP - Gas fuel lines and fitting for leaks.

Inspect tank for secure mounting.

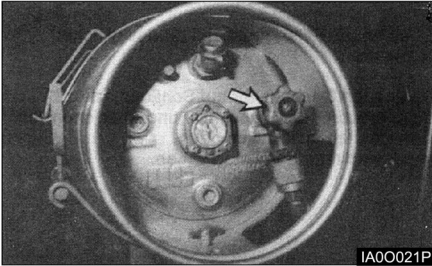

1. Open the tank fuel valve by slowly turning the valve counterclockwise. Observe the LP-Gas gauge(if equipped).
2. Turn the engine ignition switch to the START position. Release it when the engine starts.
3. If the engine does not start, do not press on the accelerator pedal. Turn the starter switch to OFF position, then repeat step 2 and depress the accelerator pedal slightly during cranking.
4. Allow the engine to warm up slowly.

Starting From a 12 Volt External Source

⚠ WARNING

Sparks occurring near the battery could cause vapors to explode.

Always connect the external power source ground cable to a point away from and below the battery, and well clear of fuel system components.

NOTICE

Do not reverse battery cables. It can cause damage to the alternator.

Always connect the external power source cables in parallel with the lift truck battery cables : POSITIVE(+) to POSITIVE(+) and NEGATIVE(-) to NEGATIVE(-).

Attach ground cable last, remove first. All lift trucks equipped with *DOOSAN* built internal combustion engines are NEGATIVE(-) ground.

After Starting the Engine

Observe all indicator lights and gauges frequently during operation, to make sure all systems are working properly. All of the indicator lights will come ON with the ignition switch in the ON position before the engine is started.

Diesel (24V)

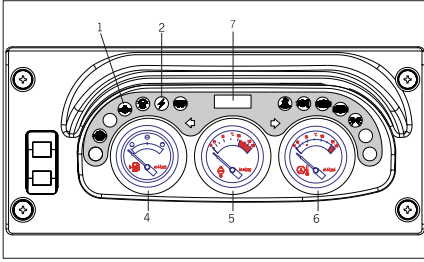

5. The engine coolant temperature gauge pointer (5), will be in the green band with the engine running, unless the coolant temperature is excessive.



6. The power shift transmission oil temperature gauge pointer (6), will be in the green band with the engine running, unless the oil temperature is excessive.

7. Observe the hour meter (7) to make sure it is operating properly.

LPG (12V)

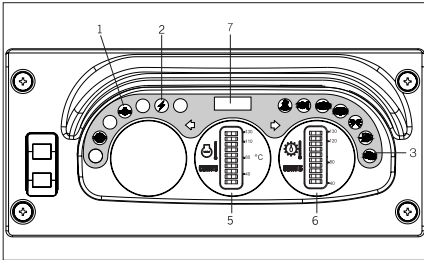

1. The engine oil pressure indicator light (1), will not come ON with the engine running, unless there is low or no oil pressure. Stop the engine immediately, if the light comes ON.



2. The alternator indicator light (2), should not come ON during normal operation. The alternator is not charging if the light comes ON with the engine running.



3. The G643E engine MIL (Malfunction Indicator Light)(3) will not come ON with engine running, unless the fault or faults are stored in the memory of the engine control module (ECM). Stop the engine and check the electric engine control system if the light comes ON. Refer G643E Engine of this section.



4. Observe the diesel fuel level gauge (4) for fuel level in the tank.(Diesel Engine Only)

G643E Electronic Controlled LP Engines (If Equipped)

General Description

The MI-04 is a closed loop system utilizing a catalytic muffler to reduce the emission level in the exhaust gas. In order to obtain maximum effect from the catalyst, an accurate control of the air fuel ratio is required. A small

engine control module (SECM) uses a heated exhaust gas oxygen sensor (HEGO) in the exhaust system to monitor exhaust gas content.

MI-04 System

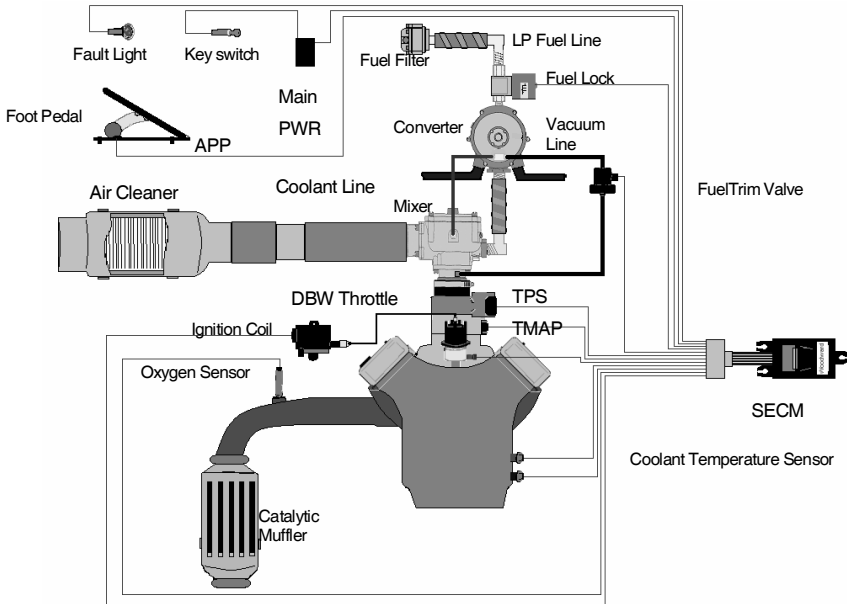

The SECM makes any necessary corrections to the air fuel ratio by controlling the inlet fuel pressure to the air/fuel mixer by modulating the fuel trim valve (FTV) connected to the regulator. Reducing the fuel pressure leans the air/fuel mixture and increasing the fuel pressure enriches the air/fuel mixture. To calculate any necessary corrections to the air fuel ratio, the SECM uses a number of different sensors to gain information about the engines performance. Engine speed is monitored by the SECM through a variable reluctance (VR) sensor. Intake manifold air temperature and absolute pressure is monitored with a (TMAP) sensor. The MI-04 is a drive by wire (DBW) system connecting the accelerator pedal to the electronic throttle through the electrical harness, mechanical cables are not used. A throttle position sensor (TPS) monitors throttle position

in relation to the accelerator pedal position sensor (APP) feedback. Even engine coolant temperature and adequate oil pressure is monitored by the SECM. The SECM controller has full adaptive learning capabilities, allowing it to adapt control function as operating conditions change. Factors such as ambient temperature, fuel variations, ignition component wear, clogged air filter, and other operating variables are compensated.

Basic Troubleshooting

The MI-04 systems are equipped with built-in fault diagnostics. Detected system faults can be displayed by the Malfunction Indicator Lamp (MIL) and are covered in the Advanced Diagnostics section. Items such as fuel level, plugged fuel lines, clogged fuel filters and malfunctioning pressure regulators may not set a fault code by the Small Engine Control Module (SECM).

Below are basic checks that should be made before referring to the Advanced Diagnostics section, if engine or drivability problems are encountered.

Locating a problem in a propane engine is done exactly the same way as with a gasoline engine. Consider all parts of the ignition and mechanical systems as well as the fuel system.

Problem	Probable Cause	Corrective Action
Engine Cranking but Will Not Start	Fuel container empty	Fill fuel container <ul style="list-style-type: none"> Do not exceed 80% of liquid capacity
	Liquid valve closed	Slowly open liquid valve
	Excess flow valve closed	Reset excess flow valve <ul style="list-style-type: none"> Close liquid valve Wait for a "click" sound Slowly open liquid valve
	Plugged fuel line	Remove obstruction from the fuel line <ul style="list-style-type: none"> Close liquid fuel valve Using caution, disconnect the fuel line (some propane may escape) Clear obstruction with compressed air Re-connect fuel line Slowly open liquid fuel valve Leak test
	Broken Fuse - SECM	Replace Fuse for SECM <ul style="list-style-type: none"> See <i>Maintenance Section, Fuses replacement</i>
	Clogged fuel filter	Repair/replace as required <ul style="list-style-type: none"> See <i>Maintenance Section, LP Fuel Filter replacement</i>
	Faulty vapor connection between the pressure regulator/converter and the mixer	Check connection <ul style="list-style-type: none"> Verify no holes in hose Clamps must be tight Look for kinked, pinched and/or collapsed hose
	Fuel Lock-off malfunction	Repair/replace Fuel Lock-off <ul style="list-style-type: none"> See <i>G643E Engine Service Manual</i>
	Pressure regulator/converter malfunction	Test pressure regulator/converter operation <ul style="list-style-type: none"> See <i>G643E Engine Service Manual</i>
	Incorrect air/fuel or ignition/spark control	See Advanced Diagnostics

Problem	Probable Cause	Corrective Action
Engine Cranking but Will Not Start	No VR Sensor Signal	Verify the VR signal is present <ul style="list-style-type: none"> • See Advanced Diagnostics
Difficult to Start	Fuel container almost empty	LPG Vapor from liquid outlet <ul style="list-style-type: none"> • Fill fuel container • Do not exceed 80% of liquid capacity
	Excess flow valve closed	Reset excess flow valve <ul style="list-style-type: none"> • Close liquid valve • Wait for a “click” sound Slowly open liquid valve
	Clogged fuel filter	Repair/replace as required <ul style="list-style-type: none"> • See <i>Maintenance Section, LP Fuel Filter replacement</i>
	Plugged fuel line	Remove obstruction from the fuel line <ul style="list-style-type: none"> • Close liquid fuel valve • Using caution, disconnect the fuel line (some propane may escape) • Clear obstruction with compressed air • Re-connect fuel line • Slowly open liquid fuel valve • Leak test
	Faulty vapor connection between the pressure regulator/convertor and the mixer	Check connection <ul style="list-style-type: none"> • Verify no holes in hose • Clamps must be tight • Look for kinked, pinched and/or collapsed hose
	Pressure regulator/convertor malfunction	Test pressure regulator/convertor operation <ul style="list-style-type: none"> • See <i>G643E Engine Service Manual</i>
	Fuel container almost empty	LPG Vapor from liquid outlet <ul style="list-style-type: none"> • Fill fuel container • Do not exceed 80% of liquid capacity
	Air filter clogged	Check air filter <ul style="list-style-type: none"> • Clean/replace as required
	Incorrect air/fuel or ignition control	See Advanced Diagnostics
	Engine Mechanical	See Engine Service Manual

Problem	Probable Cause	Corrective Action
Will Not Run Continuously	Fuel container almost empty	LPG Vapor from liquid outlet <ul style="list-style-type: none"> • Fill fuel container • Do not exceed 80% of liquid capacity
	Excess flow valve closed	Reset excess flow valve <ul style="list-style-type: none"> • Close liquid valve • Wait for a “click” sound • Slowly open liquid valve
	Clogged fuel filter	Repair/replace as required <ul style="list-style-type: none"> • See <i>Maintenance Section, LP Fuel Filter replacement</i>
	Plugged fuel line	Remove obstruction from the fuel line <ul style="list-style-type: none"> • Close liquid fuel valve • Using caution, disconnect the fuel line (some propane may escape) • Clear obstruction with compressed air • Re-connect fuel line • Slowly open liquid fuel valve & Leak test
	Pressure regulator freezes	Check level in cooling system <ul style="list-style-type: none"> • Must be full, check coolant strength • -35F minimum Check coolant hoses <ul style="list-style-type: none"> • Watch for kinks and/or pinched hoses • Verify one pressure hose and one return hose
	Fuel Lock-off malfunction	Repair/replace Fuel Lock-off <ul style="list-style-type: none"> • See <i>G643E Engine Service Manual</i>
	Incorrect idle speed or ignition problem	See Advanced Diagnostics
Engine Mechanical	See Engine Service Manual	
Will Not Accelerate/Hesitation During Acceleration	Fuel container almost empty	LPG Vapor from liquid outlet <ul style="list-style-type: none"> • Fill fuel container • Do not exceed 80% of liquid capacity
	Excess flow valve closed	Reset excess flow valve <ul style="list-style-type: none"> • Close liquid valve • Wait for a “click” sound • Slowly open liquid valve

Problem	Probable Cause	Corrective Action
Will Not Accelerate/Hesitation During Acceleration	Clogged fuel filter	Repair/replace as required <ul style="list-style-type: none"> • See <i>Maintenance Section, LP Fuel Filter replacement</i>
	Faulty vapor connection between the pressure regulator/converter and the mixer	Check connection <ul style="list-style-type: none"> • Verify no holes in hose • Clamps must be tight • Look for kinked, pinched and/or collapsed hose
	Throttle butterfly valve not opening or sticking	See Advanced Diagnostics
	Foot Pedal signal incorrect or intermittent	
	Incorrect air/fuel or ignition control	
Engine Mechanical	See Engine Service Manual	
Engine Stalls	Fuel container almost empty	LPG Vapor from liquid outlet <ul style="list-style-type: none"> • Fill fuel container • Do not exceed 80% of liquid capacity
	Excess flow valve closed	Reset excess flow valve <ul style="list-style-type: none"> • Close liquid valve • Wait for a “click” sound • Slowly open liquid valve
	Clogged fuel filter	Repair/replace as required <ul style="list-style-type: none"> • See <i>Maintenance Section, LP Fuel Filter replacement</i>
	Plugged fuel line	Remove obstruction from the fuel line <ul style="list-style-type: none"> • Close liquid fuel valve • Using caution, disconnect the fuel line (some propane may escape) • Clear obstruction with compressed air • Re-connect fuel line • Slowly open liquid fuel valve & Leak test

Problem	Probable Cause	Corrective Action
Engine Stalls	Fuel Lock-off malfunction	Repair/replace Fuel Lock-off <ul style="list-style-type: none"> • See <i>G643E Engine Service Manual</i>
	Faulty vapor connection between the pressure regulator/converter and the mixer	Check connection <ul style="list-style-type: none"> • Verify no holes in hose • Clamps must be tight • Look for kinked, pinched and/or collapsed hose
	Pressure regulator freezes	Check level in cooling system <ul style="list-style-type: none"> • Must be full, check coolant strength • -35F minimum Check coolant hoses <ul style="list-style-type: none"> • Watch for kinks and/or pinched hoses • Verify one pressure hose and one return hose
	Pressure regulator malfunction	Test pressure regulator operation <ul style="list-style-type: none"> • See <i>G643E Engine Service Manual</i>
	Vacuum leak	Check for vacuum leaks <ul style="list-style-type: none"> • Between mixer and throttle body • Between throttle body and intake manifold • Between intake manifold and cylinder head
	Air/Fuel Mixer malfunction	Check mixer <ul style="list-style-type: none"> • See <i>G643E Engine Service Manual</i>
	Engine Mechanical	See Engine Manufacturers Service Manual
Rough Idle	Faulty vapor connection between the pressure regulator/converter and the mixer	Check connection <ul style="list-style-type: none"> • Verify no holes in hose • Clamps must be tight • Look for kinked, pinched and/or collapsed hose
	Pressure regulator malfunction	Test pressure regulator operation <ul style="list-style-type: none"> • See <i>G643E Engine Service Manual</i>
	Vacuum leak	Check for vacuum leaks <ul style="list-style-type: none"> • Between mixer and throttle body • Between throttle body and intake manifold • Between intake manifold and cylinder head
	Air/Fuel Mixer malfunction	Check mixer <ul style="list-style-type: none"> • See <i>G643E Engine Service Manual</i>

Problem	Probable Cause	Corrective Action
Rough Idle	Incorrect Idle speed control	See Advanced Diagnostics & See G643E Engine Service Manual
	Incorrect timing or spark control	
	Engine Mechanical	See Engine Service Manual
High Idle Speed	Incorrect Idle speed control	See Advanced Diagnostics & See G643E Engine Service Manual
	Throttle sticking	
	Foot pedal sticking or incorrect pedal signal	Check pedal return spring travel for binding <ul style="list-style-type: none"> • See <i>Advanced Diagnostics</i>
Poor High Speed Performance	Clogged fuel filter	Repair/replace as required <ul style="list-style-type: none"> • See <i>Maintenance section, Fuel Filter replacement</i>
	Plugged fuel line	Remove obstruction from the fuel line <ul style="list-style-type: none"> • Close liquid fuel valve • Using caution, disconnect the fuel line (some propane may escape) • Clear obstruction with compressed air • Re-connect fuel line • Slowly open liquid fuel valve & Leak test
	Air filter clogged	Check air filter <ul style="list-style-type: none"> • <i>Clean/replace as required</i>
	Faulty vapor connection between the pressure regulator/converter and the mixer	Check connection <ul style="list-style-type: none"> • Verify no holes in hose • Clamps must be tight • Look for kinked, pinched and/or collapsed hose
	Pressure regulator malfunction	Test pressure regulator operation <ul style="list-style-type: none"> • See <i>G643E Engine Service Manual</i>
	Air/Fuel Mixer malfunction	Check mixer <ul style="list-style-type: none"> • See <i>G643E Engine Service Manual</i>
	Restricted exhaust system	Check exhaust system <ul style="list-style-type: none"> • Measure exhaust back pressure
	Incorrect ignition control	See Advanced Diagnostics & See G643E Engine Service Manual
	Incorrect air/fuel control	
	Incorrect throttle position	

Problem	Probable Cause	Corrective Action
Excessive Fuel Consumption/LPG Exhaust Smell	Air/Fuel Mixer malfunction	Check mixer <ul style="list-style-type: none"> • See <i>G643E Engine Service Manual</i>
	Air filter clogged	Check air filter <ul style="list-style-type: none"> • Clean/replace as required
	Vacuum leak	Check system vacuum hoses from regulator to FTV and mixer <ul style="list-style-type: none"> • Repair/replace as necessary
	Pressure regulator malfunction/fuel pressure too high	Test pressure regulator operation <ul style="list-style-type: none"> • See <i>G643E Engine Service Manual</i>
	Faulty FTV	Check FTV for housing cracks or obstructions <ul style="list-style-type: none"> • See <i>Advanced Diagnostics FTV operation</i> • Repair and/or replace as necessary
	Weak ignition and/or spark control	See Advanced Diagnostics
	Incorrect air/fuel control	See Advanced Diagnostics
	Exhaust system leaks	Repair exhaust system
	Oxygen sensor failure	Replace as necessary <ul style="list-style-type: none"> • See <i>Advanced Diagnostics</i>

Advanced Diagnostics

Advanced Diagnostics

The MI-04 systems are equipped with built-in fault diagnostics. Detected system faults can be displayed by the Malfunction Indicator Lamp (MIL) as Diagnostic Fault Codes (DFC) or flash codes, and viewed in detail with the use of service tool software. When the ignition key is turned ON the MIL will perform a self-test, illuminate once and then go OFF. If a detected fault condition exists, the fault or faults will be stored in the memory of the small engine control module (SECM). Once a fault occurs the MIL will illuminate and remain ON. This signals the operator that a fault has been detected by the SECM.

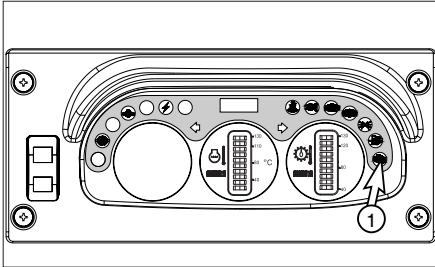

(1) Malfunction Indicator Lamp(MIL) for Engine control system

Reading Diagnostic Fault Codes

All MI-04 fault codes are two digit codes. When the fault codes are retrieved (displayed) the MIL will flash for each digit with a short pause (.5 seconds) between digits and a long pause (1.2 seconds) between fault codes. A code 12 is displayed at the beginning of the code list.

EXAMPLE: A code 26 has been detected (ETCSticking) and the engine has shutdown and the MIL has remained ON. When the codes are displayed the MIL will flash one time (1), pause, then flash two times (2). This identifies a twelve (12), which is the beginning of the fault list. It will then pause for 1.2 seconds (long pause) and flash two times (2), pause, then flash six times (6). This identifies a twenty-six (26), which is the ETCSticking fault. If any additional faults were stored the SECM would again have a long pause, then display the next fault by flashing each digit. Since no other faults were stored there will be a long pause then one flash (1), pause, then two flashes (2). This identifies a twelve meaning the fault list will begin again.

Displaying Fault Codes (DFC) From SECM Memory

To enter code display mode you must turn **OFF** the ignition key. Now turn **ON** the key but do not start the engine. As soon as you turn the key to the **ON** position you must cycle the foot pedal by depressing it to the floor and then fully releasing the pedal (pedal maneuver). You must fully cycle the foot pedal three (3) times within five (5) seconds to enable the display codes feature of the SECM. Simply turn the key **OFF** to exit display mode. The code list will continue to repeat until the key is turned **OFF**. An automatic code display feature is activated if a foot pedal fault condition exists. This feature enables the service technician to view the fault codes by turning the key to the **ON** position, if a foot pedal malfunction is preventing the retrieval of the stored fault codes from the SECM.

Malfunction Indicator Light (MIL)

 = CODE 12
ON OFF ON ON OFF

Table a. MI-04 Diagnostic Fault Codes (Flash Codes)

DFC	Probable Fault	Action	Corrective Action, First Check
12	NONE Signifies the end of one pass through the fault list	NONE	None, used as a beginning and end of the fault list identification
14	ECTSensorInputLow Coolant sensor failure or shorted to GND	Stored Fault Code (MIL Only)	Check ECT sensor connector and wiring for a short to GND
15	ECTSensorInputHigh Coolant sensor disconnected or open circuit	Stored Fault Code (MIL Only)	Check if ECT sensor connector is disconnected or for an open ECT circuit
16	ECTRangeHigh Engine Overheating	Delayed Engine Shutdown	Check coolant system for radiator blockage, proper coolant level and for leaks in the system. Possible ECT short to GND, check ECT signal wiring Check regulator for coolant leaks
22	ThrottleSensorInputLo TPS1 signal disconnected or open circuit (Expected faults when ETC connector is unplugged CODES: 22 & 24)	Disable Throttle	Check throttle connector connection and TPS1 sensor for an open circuit
23	ThrottleSensorInputHi TPS1 sensor failure or shorted circuit	Disable Throttle	Check throttle connector and TPS1 sensor wiring for a shorted circuit
24	ThrottleSensorRangeLo TPS1 potentiometer malfunction. Improper TPS reading may be due to dirt or oxidation on the sensor traces.	Stored Fault Code (MIL Only)	Check the throttle connector and pins for corrosion.
25	ThrottleSensorRangeHi TPS1 potentiometer malfunction. Improper TPS reading may be due to dirt or oxidation on the sensor traces.	Stored Fault Code (MIL Only)	Check the throttle connector and pins for corrosion.

Table a. MI-04 Diagnostic Fault Codes (Flash Codes)

DFC	Probable Fault	Action	Corrective Action, First Check
26	<p>ETCSticking</p> <p>Throttle plate sticking inside the throttle body or the ETC driver signal is open</p>	Engine Shutdown	<p>Check for debris or obstructions inside the throttle body</p> <p>Check throttle-plate shaft for bearing wear</p> <ul style="list-style-type: none"> • Check the ETC driver wiring for an open circuit
27	<p>PredictedTPSDifference</p> <p>Measured TPS1 is different than SECM Calculated throttle position</p>	Engine Shutdown	<p>Check for manifold leaks between the throttle and the engine</p> <p>Note: Fault Code 27 is predicted TPS. This fault means that the throttle and our calculated prediction for throttle do not agree. This code often comes up as suspected during transient maneuvers. It is not system trouble. If the fault really sets, then the engine will shut down.</p>
28	<p>ETCSpringTestFailed</p> <p>Upon initial key-up the internal throttle return spring has become weak</p>	Power Limit	Perform throttle spring test by cycling the ignition key and re-check for fault
29	<p>ETCDriverFault</p> <p>Throttle driver over-current or driver signals shorted</p>	Disable Throttle	<p>Check ETC driver wiring for a shorted circuit</p> <p>ETC+ PIN1 to SECM PIN 22</p> <p>ETC- PIN 4 to SECM PIN 24</p> <p>Perform Throttle test and with the Service Tool and re-check for fault</p> <p>Check the ETC internal motor drive by disconnecting the throttle connector and measuring the motor drive resistance at the throttle</p> <p>TPS PIN 1 (+DRIVER) to PIN 4 (-DRIVER) $-3.0\Omega \pm 30\%$</p>
33	<p>MapSensorInputLow</p> <p>MAP signal disconnected, open circuit or sensor malfunction</p> <p>(Expected faults when TMAP connector is unplugged</p> <p>CODES: 33 & 38)</p>	Disable Throttle	Check TMAP connector and MAP signal wiring for an open circuit

Table a. MI-04 Diagnostic Fault Codes (Flash Codes)

DFC	Probable Fault	Action	Corrective Action, First Check
34	MapSensorInputHigh TMAP sensor failure or shorted circuit	Disable Throttle	Check TMAP connector and MAP signal wiring for a shorted circuit
37	IATSensorInputLow TMAP sensor failure or shorted circuit	Stored Fault Code (MIL Only)	Check TMAP connector and IAT signal wiring for a shorted circuit
38	IATSensorInputHigh IAT signal disconnected, open circuit or sensor malfunction	Stored Fault Code (MIL Only)	Check TMAP connector and IAT signal wiring for an open circuit TMAP PIN 2 to SECM PIN 4 (SIGNAL) TMAP PIN 1 to SECM PIN 1 (GND) TMAP PIN 3 to SECM PIN 18 (XDCR +5VDC) To check the IAT sensor of the TMAP disconnect the TMAP connector and measure the IAT resistance *See the IAT table in Chapter 6.0
42	EST1Low Coil driver signal low or under-current	Stored Fault Code (MIL Only)	Check coil driver wiring and connector for shorts SECM PIN 7(EST1) to COIL PIN A Verify GND on COIL PIN B Verify GND on COIL PIN C Verify GND on COIL PIN D Verify +12vdc on COIL PIN E To check the Smart Coil internal circuit disconnect the coil connector and measure the resistance from pin to pin *See Smart Coil resistance check in Chapter 6.0
43	EST1High Coil driver signal high or over-current	Stored Fault Code (MIL Only)	Check coil driver wiring for an open circuit or disconnected connector

Table a. MI-04 Diagnostic Fault Codes (Flash Codes)

DFC	Probable Fault	Action	Corrective Action, First Check
53	<p>BatterySensorInputLow</p> <p>Battery voltage measured below +8.0 VDC</p>	<p>Stored Fault Code (MIL Only)</p>	<p>Check battery voltage</p> <p>Perform maintenance check on electrical connections to the battery and chassis ground</p> <ul style="list-style-type: none"> • Check battery voltage during starting and with the engine running to verify charging system and alternator function • • Measure battery power at the SECM with a multimeter
54	<p>BatterySensorInputHigh</p> <p>Battery voltage measured above +15.9 VDC</p>	<p>Stored Fault Code (MIL Only)</p>	<p>Check battery and charging system voltage</p> <p>Check battery voltage during starting and with the engine running</p> <p>Check voltage regulator, alternator and charging system</p> <p>Check battery and wiring for overheating and damage</p> <p>Measure battery power at the SECM with a multimeter</p>
55	<p>XDRPSensorInputLow</p> <p>+5VDC Transducer power supplied by the SECM to the sensors is below +4.60VDC</p> <p>(Expected faults when Transducer power is lost</p> <p>CODES: 22, 24, 33, 62, 64, 66, 68 & 69)</p>	<p>Engine Shutdown</p>	<p>Measure transducer power at the TMAP connector with a multimeter</p> <p>Verify transducer power at the SECM with a multimeter</p> <p>Verify transducer power at ETC with a multimeter</p> <p>Verify transducer power to the foot pedal with a multimeter</p>

Table a. MI-04 Diagnostic Fault Codes (Flash Codes)

DFC	Probable Fault	Action	Corrective Action, First Check
56	XDRPSensorInputHigh +5VDC Transducer power supplied by the SECM to the sensors is above +5.20VDC	Engine Shutdown	Measure transducer power at the TMAP connector with a multimeter Verify transducer power at the SECM with a multimeter Verify transducer power at ETC with a multimeter Verify transducer power to the foot pedal with a multimeter
57	Engine OverSpeed Engine RPM increased beyond maximum RPM set point	Engine Shutdown	Usually associated with additional ETC faults <ul style="list-style-type: none"> • Check for ETC Sticking or other ETC faults • Verify if the lift truck was motored down a steep grade
61	Pedal1SensorInputLo APP1 signal disconnected, open circuit or sensor malfunction (Expected faults when APP connector is unplugged CODES: 61 & 66)	MIN Power Limit	Check foot pedal connector
62	Pedal1SensorInputHi APP1 sensor failure or shorted circuit	MIN Power limit	Check foot pedal connector
63	Pedal1SensorRangeLo APP1 potentiometer malfunction. Improper APP1 reading may be due to dirt or oxidation on the sensor traces.	Stored Fault Code (MIL Only)	Check foot pedal connector
64	Pedal1SensorRangeHi APP1 potentiometer malfunction. Improper APP1 reading may be due to dirt or oxidation on the sensor traces	Stored Fault Code (MIL Only)	Check foot pedal connector

Table a. MI-04 Diagnostic Fault Codes (Flash Codes)

DFC	Probable Fault	Action	Corrective Action, First Check
65	Pedal2SensorInputLo APP2 sensor failure or shorted circuit	MIN power Limit	Check foot pedal connector
66	Pedal2SensorInputHi APP2 signal disconnected, open circuit or sensor malfunction (Expected faults when APP connector is unplugged CODES: 61 & 66)	MIN power Limit	Check foot pedal connector
67	Pedal2SensorRangeLo APP2 potentiometer malfunction. Improper APP2 reading may be due to dirt or oxidation on the sensor traces.	Stored Fault Code (MIL Only)	Check foot pedal connector
68	Pedal2SensorRangeHi APP2 potentiometer malfunction. Improper APP2 reading may be due to dirt or oxidation on the sensor traces.	Stored Fault Code (MIL Only)	Check foot pedal connector
69	Pedal1ToPedal2Difference Measured APP2 pedal position signal is different than APP1 signal	MIN power Limit	Check foot pedal connector
71	AFRTimValveOutput FTV modulation driver signal fault	Stored Fault Code (MIL, Disable Adaptive learns)	Check FTV for an open wire or FTV connector being disconnected

Table a. MI-04 Diagnostic Fault Codes (Flash Codes)

DFC	Probable Fault	Action	Corrective Action, First Check
72	<p>AFRTrimValveLowerDC</p> <p>FTV duty cycle at lower (lean) limit</p>	<p>Stored Fault Code</p> <p>(MIL, Disable Adaptive learns)</p>	<p>Engine measured Air/Fuel ratio at the O2 sensor is excessively lean.</p> <p>If LP-Gas fuel in LP tank is not enough, this fault code can be set. If LP tank is frozen, this fault code can be set, too. It is not system trouble.</p> <ul style="list-style-type: none"> • Check for intake manifold leaks • Check balance line (vacuum hose) connection at the regulator • Check N-CA55-500-TR mixer for heavy end build-up and operation (see mixer section) • Check N2001 secondary for operation or low primary pressure (see N2001 Regulator section) •
73	<p>AFRTrimValveUpperDC</p> <p>FTV duty cycle at high (rich) limit</p> <p>(Expected fault when FTV connector is unplugged)</p>	<p>Stored Fault Code</p> <p>(MIL, Disable Adaptive learns)</p>	<p>Engine measured Air/Fuel ratio at the O2 sensor is excessively rich</p> <p>Check FTV connector wiring for an open circuit</p> <ul style="list-style-type: none"> • Check N-CA55-500-TR mixer for heavy end build-up and operation (see mixer section) • Check N2001 secondary for operation (see N2001 Regulator section)

Table a. MI-04 Diagnostic Fault Codes (Flash Codes)

DFC	Probable Fault	Action	Corrective Action, First Check
74	O2SensorSwitching O2 sensor is not switching across the reference AFR voltage	Stored Fault Code (MIL, Disable Adaptive learns)	Note : If LP-Gas fuel in LP tank is not enough, this fault code can be set. If LP tank is frozen, this fault code can be set, too. It is not system trouble. Check the FTV for proper operation <ul style="list-style-type: none"> • Check FTV Hose Connections •
77	OxygenSensorInputHigh O2 sensor SECM driver signal is shorted to power	Stored Fault Code (MIL, Disable Adapts)	Check if O2 sensor is shorted to +5VDC or Battery. (AFRTrimValveLowerDC fault should also occur)

Lift Truck Operation

Power Shift Transaxle

1. Start the engine. See topic “Starting the Engine.”

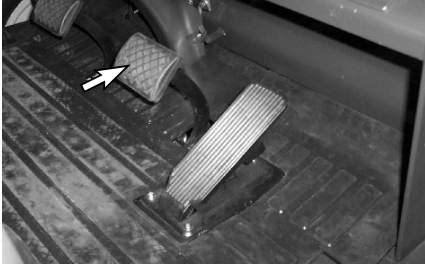

2. Push down on the service brake pedal to hold the lift truck until ready to move it.
3. Release the parking brake.

NOTE: The parking brake must be released before the directional control can be used.



4. Select the direction of travel by pushing the directional lever FORWARD for forward direction or by pulling the lever BACK for reverse direction.

WARNING

A lift truck with the engine running but without an operator can move slowly (creep) if the transmission is engaged.

This could result in personal injury.

Always place the transmission control lever in the NEUTRAL (center) position and apply the parking brake before dismounting the lift truck.

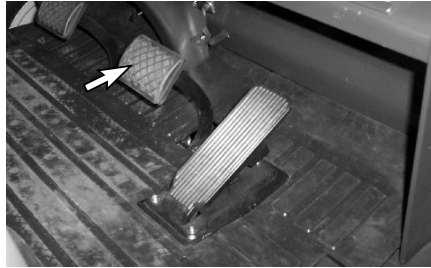

5. Release the service brake.
6. Push down on the accelerator pedal to obtain the desired travel speed. Release the pedal to decrease travel speed.

WARNING

Sudden reversal of a loaded lift truck traveling forward can cause the load to fall or the lift truck to tip.

Stop the loaded lift truck completely, before shifting to reverse.

Failure to comply could result in personal injury.

NOTE: Where conditions permit, directional changes can be made under full power at speeds up to 6 km/h (3.73mph). A speed of 6 km/h (3.73mph) is a fast walk. Directional shift changes at speeds above 6 km/h (3.73mph) are considered abusive.

Bring the lift truck to a complete stop where load stability or other factors prevent safe operation under full power shifts.

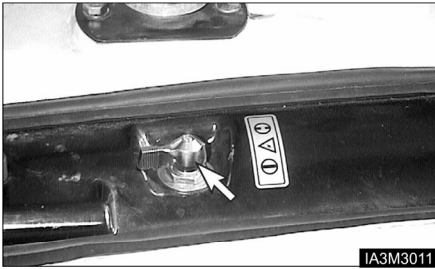

7. To change the lift truck direction of travel, release the accelerator pedal.
8. Push down on the service brake pedal to reduce the lift truck speed as necessary.



9. Move the directional lever to the desired direction of travel. Slowly push down on the accelerator pedal as the lift truck changes direction.
10. When the direction change is completed, continue to push down on the accelerator pedal to obtain the desired travel speed.

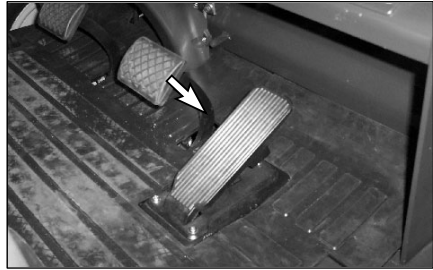

11. To stop the lift truck when traveling in either direction, release the accelerator pedal.
12. Push down on the service brake pedal and bring the lift truck to a smooth stop.

Inching

NOTE: The purpose of the inching pedal is to provide precise lift truck inching control at very slow travel speed and high engine rpm. This is used for fast hydraulic lift, during load approach, pick up or load positioning.

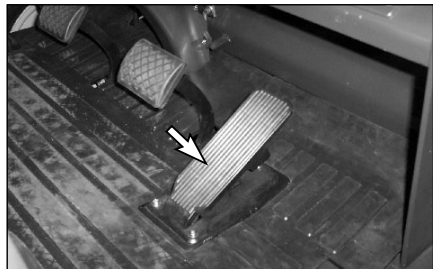

1. To inch (creep) in either direction, slowly push down on the inching pedal. This will start to apply the service brakes and allow the transmission clutch discs to slip.
2. Vary the position of the inching pedal and the accelerator pedal to control the inching speed and distance.
3. Pushing down further on the inching pedal will disengage the transmission completely and apply the service brakes fully to stop and hold the lift truck. This will provide full engine power for fast hydraulic lift.

Auto Shift Controller ASC - 200 (If Equipped)

Product Description

The Autoshift controller is an electrical control system, specially designed for use on forklift trucks with internal combustion engines.

Its primary purpose is to prevent the operator from operating the truck outside of the design parameters, e.g. selecting the reverse gear when traveling in excess of 6.0 km/h (3.73mph) in a forward direction, and vice versa.

The Autoshift controller is mounted on a convenient position away from excessive heat sources and retrofits into the truck's electrical system. An inductive speed sensor is mounted on the transmission case where it will pick up a pulse from a gear tooth pattern. This pulse is used to monitor the truck in motion and its travel speed. To enable the system to change gears smoothly, the shift points for offset speed are adjustable.

An operator no longer has to change gears with his hands, therefore he can be more productive.

The Autoshift controller prevents strain and abuse to the transmission by changing gears up and down automatically. It also prevents damage to the half shaft, excessive tire wear and heat to the transmission.

Features

- 1) 2 - speed auto shift control
- 2) Prevent downshifting at high speed
- 3) Inhibit selecting direction at high speed outside of the design parameters.



Adjustments

SW1 (Low-High Shift Point)		SW2 (Direction Inhibit Point)	
NOTCH	Vehicle Speed	NOTCH	Vehicle Speed
0	2.5 km/h (1.55 mph)	0	3.3 km/h (2.05 mph)
1	3.0 km/h (1.86 mph)	1	3.6 km/h (2.24 mph)
2	3.5 km/h (2.17 mph)	2	3.9 km/h (2.42 mph)
3	4.0 km/h (2.49 mph)	3	4.2 km/h (2.61 mph)
4	4.5 km/h (2.80 mph)	4	4.5 km/h (2.80 mph)
5	5.0 km/h (3.11 mph)	5	4.8 km/h (2.98 mph)
6	5.5 km/h (3.42 mph)	6	5.1 km/h (3.17 mph)
7	6.0 km/h (3.73 mph)	7	5.4 km/h (3.36 mph)
8	6.5 km/h (4.04 mph)	8	5.7 km/h (3.54 mph)
9	7.0 km/h (4.35 mph)	9	6.0 km/h (3.73 mph)

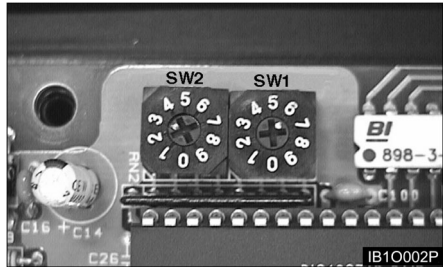

Adjustment Switch

Low-High Shift Point (SW1)

ASC-200 allows you to set the 2 speed Auto Gear Shift Point, the maximum travel speed at which the Auto Shift Controller up-shift or down-shift the transmission automatically according to the vehicle speed. For adjustment of 2 speed Auto Gear Shift speed, the SW1 switch is used on the printed circuit board.

For example if SW1 put to 5th notch, the 2 Speed Auto Gear Shift speed will be 5.0 km/h(3.11 mph), which is factory setting value as a default.

Direction Inhibit Point (SW2)

Auto Shift allows you to set the Direction Inhibit Speed, the maximum travel speed at which the transmission can be reversed. For adjustment of direction inhibit speed, the SW2 switch is used on the printed circuit board.

For example SW2 is put to 7th notch, the Direction Inhibit Speed will be 5.4 km/h(3.36 mph), which is factory setting value as a default.

Diagnostics Features

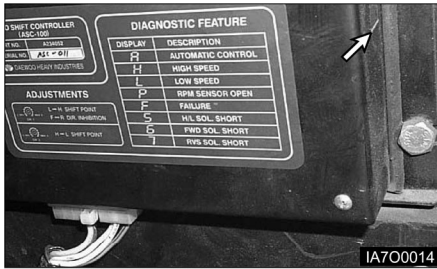

ASC-200 has internal indicator on the right side of the controller for displaying the selected gear and the abnormal condition.

WARNING

Do not diagnose or repair Auto Shift Controller Faults unless trained and authorized to do so. Improper performance of maintenance procedures is dangerous and could result in personal injury or death.

Below is a description applicable for many ASC-200 implementations.

Display for Operator

Display	Description	Remark
A	Automatic operation	
H	High speed	At 2nd shift gear
L	Low speed	At 1st shift gear
P	T/M Speed sensor open	Flashing
E	E/G Speed sensor open	Flashing
F	Controller fault	Flashing
5	H/L Sol. Short	Flashing
6	Forward Sol. Short	Flashing
7	Reverse Sol. Short	Flashing

This information is given during normal operating when something special happens. For example, on ASC-200's with the speed sensor, one of the indicators is used to indicate a sensor problem.

Display for Troubleshooting

Display	Description	Remark
A	Automatic operation	
2	High speed s/w input	Lever input test
3	Forward s/w input	Lever input test
4	Reverse s/w input	Lever input test

This information is input for signal diagnostics.

This test is used to verify operation of direction control lever.

Operation

This system can be basically operated in two preselected modes, automatic mode and manual mode. Automatic Mode is selected in factory-setting controller as a default.

Manual Mode (Fail-Safe Mode) is selected to operate the truck manually in case of emergency.

Automatic mode

Direction Inhibit

1. Start the engine with the direction control lever in NEUTRAL and the parking brake engaged.
2. Press down on the service brake pedal, disengage the parking brake and move the direction control lever to FORWARD.

NOTE: Release the parking brake before using the directional control lever.

3. Observe the LED on the Auto Shift Controller. The LED should indicate "A" while the direction control lever is in FORWARD, NEUTRAL and REVERSE. Report Auto Shift as faulty if the LED indicates anything other than "A".
4. Keep the service brake pushed down until ready to move the truck.
5. To change directions of a traveling lift truck when the Auto Shift Controller LED displays "A", shift the direction control lever to the opposite direction and wait for the lift truck to change direction.
6. If however, your travel speed is higher than the pre-selected direction change speed as direction inhibit point in the controller, Auto Shift will shift the transmission to NEUTRAL until the lift truck's travel speed slows to the pre-selected direction change speed, and then shift the transmission to the direction selected.
7. You should be prepared to help slow the lift truck to the pre-selected direction change speed by pressing down on the service brake pedal.

⚠ WARNING

When you want to change the travel direction, you must press down on the service brake pedal to reduce the travel speed. Be cautious that the lift truck's stopping distance may be longer than in manual mode because the lift truck continues to travel forward regardless of the selection of reverse with the direction control lever until the vehicle speed is sufficiently reduced.

8. The direction of travel will change automatically when the vehicle speed is reduced as much as the pre-selected speed in the controller.

⚠ WARNING

Bring the loaded lift truck to a complete stop before changing travel direction. Changing travel direction while traveling may cause the lift truck to lose the load or tip over.

9. When the direction change is completed, continue to push down on the accelerator pedal to obtain the desired travel speed.

NOTICE

The transmission of your lift truck may be reversed under full power up to a travel of 6.0 km/h (3.73 mph). But the Inhibit Speed of Auto Shift is set by the factory at 5.4 km/h (3.36 mph) because reversing the transmission at lower travel speeds prolongs the life of the transmission, axle shafts and tires.

Two-Speed Auto Shift Control

While traveling forward with the high speed gear, that is, 2nd gear selected, the ASC-200 can up-shift or down-shift the transmission automatically according to the vehicle speed by its own speed ratio control so that the appropriate gear may be engaged in every situation.

NOTICE

Two-Speed Auto Shift Control function can be accomplished only when the direction control lever is placed in the high speed (2nd gear) position.

Manual Mode (Fail-Safe mode)

In case that the controller is broken down or you don't want to use the functions of the Auto Shift Controller, you can select Manual Mode. In Manual Mode, you can operate your lift truck in the same manner as any lift truck without Auto Shift Controller. You can select the Manual mode or the Automatic mode by doing following procedures.

⚠ WARNING

In the manual mode, direction inhibition function can not be operated normally. The sudden reversal of a loaded lift truck traveling forward can cause the load to fall or the lift truck to tip over.

An operator can operate the truck manually by selecting the Manual mode with the Fail-Safe mode switches on the PCB (Printed Circuit Board). With the switch (1) in "MANUAL" position, direction inhibit function is disable. If an operator moves the switch (2) from "AUTO" position to "MANUAL" position, then 2-speed auto shift function will become disabled. Move the switches as indicated, up of Automatic (AUTO) operation or down for Manual (MANUAL) operation.

NOTE: In the factory-setting controller, AUTO mode is selected as a default on the PCB (Printed Circuit Board) as shown below.

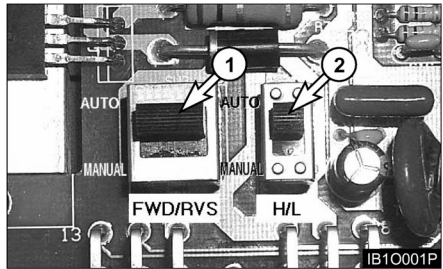

NOTE: After operating the truck manually by selecting the Manual Mode switch on PCB(Printed Circuit Board), the position of mode must be checked before operating the truck automatically.

Operating Techniques

Inching into Loads

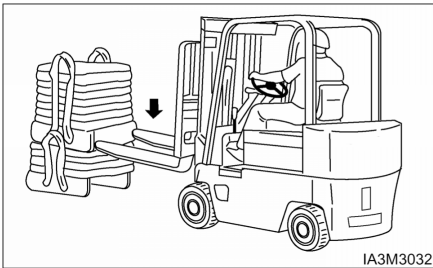

Typical Example

1. Move the lift truck slowly **FORWARD** into position and engage the load. The lift truck should be square with load, forks spaced evenly between pallet stringers and as far apart as load permits.

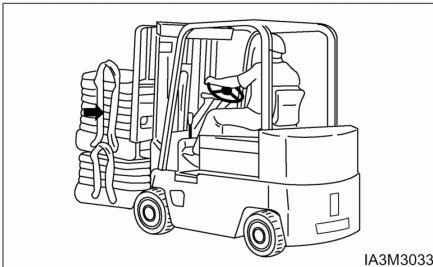

Typical Example

2. Move the lift truck **FORWARD** until the load touches the carriage.

Lifting the Load

1. Lift the load carefully and tilt the mast back a short distance.

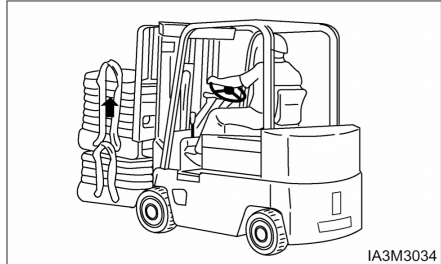

Typical Example

2. Tilt the mast further back to cradle the load.

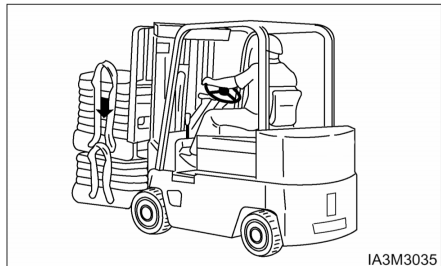

Typical Example

3. Operate the lift truck in reverse until the load is clear of the other material.
4. Lower the cradled load to the travel position.

NOTE: Lift and tilt speeds are controlled by engine rpm.

Traveling With the Load

NOTICE

Travel with the load as low as possible, while still maintaining ground clearance.

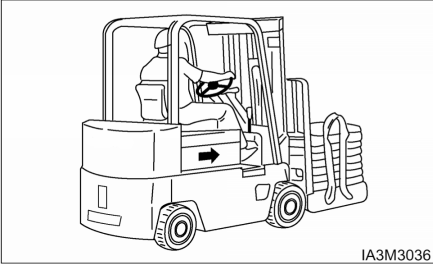

Typical Example

1. Travel with the load uphill on upgrades and downgrades.

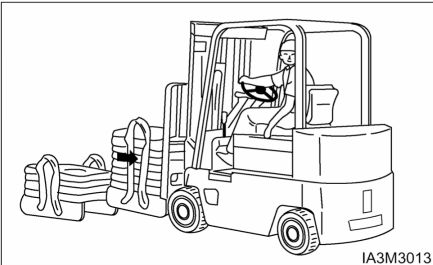

Typical Example

2. For better vision, travel in reverse with bulky loads.

Unloading

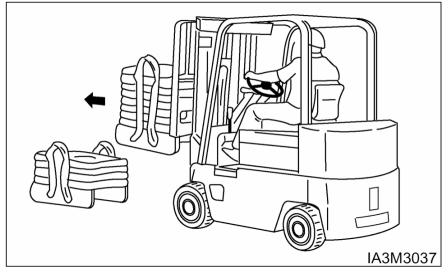

Typical Example

1. Move the lift truck into the unloading position.

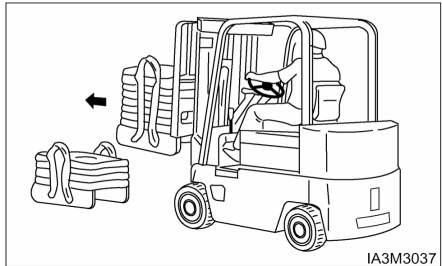

Typical Example

2. Tilt the mast FORWARD only when directly over the unloading area.

▲ WARNING

Do not tilt the mast forward with the load unless directly over the unloading area, even if the power is off.

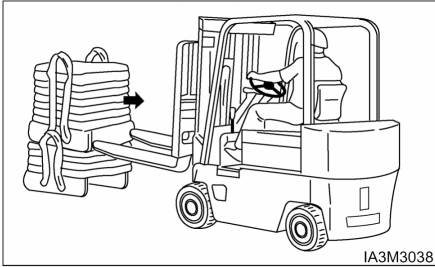

Typical Example

3. Deposit the load and BACK away carefully to disengage the forks.



Typical Example

4. Lower the carriage and forks to the travel position or to the park position.

Turning

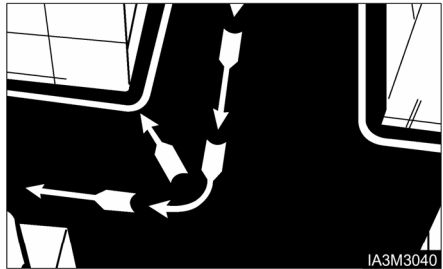

1. When turning sharp corners, keep close to the inside corner. Begin the turn when the inside drive wheel meets the corner.



2. In narrow aisles, keep away from the stockpile when turning into the aisle. Allow for counterweight swing.

Lifting Drums or Round Objects

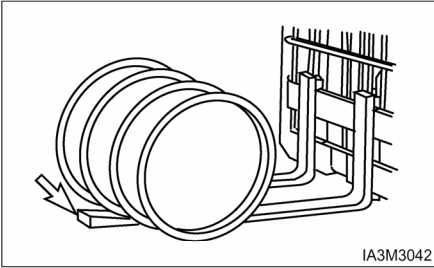

1. Block drums or round objects. Tilt the mast FORWARD and slide the fork tips along the floor to get under the load.

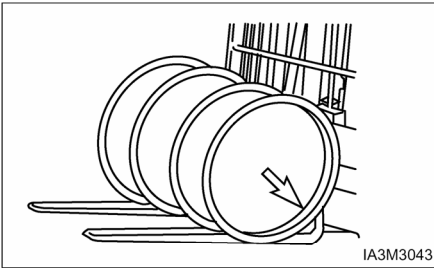

2. Before lifting, tilt the mast BACK slightly until the load is cradled on the forks.

Operating in hot weather

Keep the following points in mind when you operate the lift truck in hot weather.

1. Check the radiator. Clogging can cause overheating. Clean them out regularly with a blast of compressed air, also, check for leakage of water.
2. Check the fan belt tension and adjust to proper tension.
3. Even if the engine overheats and the coolant boils over, let the engine idle for a while with opening engine hood until temperature falls before shutting off the engine.

Parking the Lift Truck

Park the lift truck level, with the forks lowered and the mast tilted forward until the fork tips touch the floor. Block the drive wheels when parking on an incline.



1. Park in an authorized area only. Do not block traffic. If LP-Gas equipped, do not park near elevator shafts or any other area where LP-Gas could collect in a pocket (low area), causing a potentially dangerous condition.



2. Place the transmission controls in NEUTRAL.
3. Engage the parking brake.
4. Lower the forks to the ground.

WARNING

Blocking the wheels will prevent unexpected lift truck movement, which could cause personal injury.

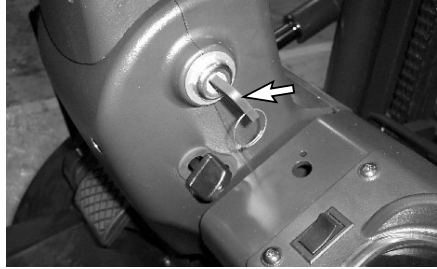

5. Turn the key in the ignition switch to the OFF position and remove the key.

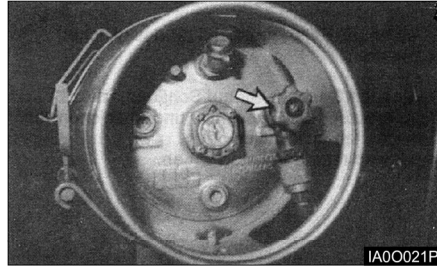

NOTE: If a LP - Gas equipped lift truck is stopped or parked for an indefinite or prolonged period of time, close the fuel shutoff valve on the LP-Gas tank. Run the engine until fuel in the line runs out and the engine stops. Turn off the ignition switch and disconnect switch (if equipped).

6. Actuate each loading lever several times to remove the residual pressure in the respective cylinders and hoses.
7. Block the drive wheels if parking on an incline.

Lift Fork Adjustment

⚠ WARNING

When adjusting the fork spread, be careful not to pinch your hand between forks and the carriage slot.

Hook - on type Fork

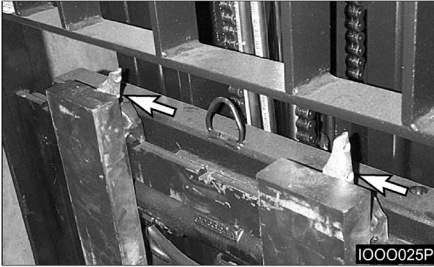

1. Move up the hook pin to the free position.
2. Raise the hook pin in each fork to side the fork on the carriage bar.
3. Adjust the forks in the position most appropriate for the load and as wide as possible for load stability.
4. When adjusting the forks, make sure that the weight of the load is centered on the truck.
5. After adjustment, set the fork locks to keep the forks in place.

⚠ WARNING

Make sure the forks are locked before carrying a load.

Storage Information

Before Storage

Before storing your lift truck, clean and inspect as the following procedures.

- Wipe away grease, oil, etc. adhering to the body of the truck with waste cloth, and use water, if needed.
- While cleaning the truck, check general condition of the truck. Especially check the truck body for dents or damage and tires for wear or nails or stones in the tread.
- Fill the fuel tank with fuel specified.
- Check for leakage of hydraulic oil, engine oil, fuel, or coolant, etc.
- Apply grease, where needed.
- Check for looseness of nuts and bolts, especially hub nuts.
- Check mast rollers to see that they rotate smoothly.
- Prime the oil into the lift cylinders by actuating the lift lever all the way several times.
- Drain off coolant completely in cold weather, if antifreeze is not used.

Long Time Storage

Perform the following service and checks in addition to the "Parking the lift truck" services.

- Taking the rainy season into consideration, park the machine at a higher and hard ground.
- Avoid parking on soft grounds such as asphalt ground in summer.
- Dismount the battery from the machine. Even though the machine is parked indoors, if the place is hot or humid, the battery should be kept in a dry, cool place. Charge the battery once a month.
- Apply antirust to the exposed parts which tend to rust.
- Cover components such as the breather and air cleaner which may be caught with humidity.
- The machine should be operated at least once a week. Fill the cooling system, if cooling water is discharged, and mount the battery. Start the engine and warm up thoroughly. Move the machine a little forwards and backwards. Operate the hydraulic controls several times.

To Operate the Lift Truck After a Long Time Storage

- Remove covers and antirust from each of the components and exposed parts.
- Drain the engine crankcase, transmission (clutch type machine), differential and final reduction gear, clean the inside of them and add new oil.
- Drain off foreign matter and water from the hydraulic oil tank and fuel tank.
- Remove the head cover from the engine cylinder. Oil valves and rocker shaft and check each valve for proper operation.
- Add cooling water to the specified level.
- Charge the battery and mount it on the machine. Connect the cables.
- Perform pre-operational checks carefully. (refer to "Before Starting the Engine")
- Warm up the machine.

Transportation Hints

Lift Truck Shipping

Check travel route for overpass clearances. Make sure there is adequate clearance if the lift truck being transported is equipped with a high mast, overhead guard or cab.

To prevent the lift truck from slipping while loading, or shifting in transit, remove ice, snow or other slippery material from the loading dock and the truck bed before loading.

NOTICE

Obey all state and local laws governing the height, weight, width and length of a load. Observe all regulations governing wide loads.

NOTICE

Remove ice, snow or other slippery material from the shipping vehicle and the loading dock.

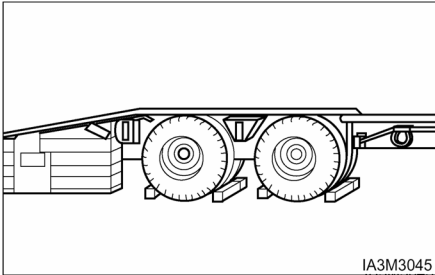

Always block the trailer or the rail car wheels before loading the lift truck.

Position the lift truck on the truck bed or the rail car.

Apply the parking brake and place the transmission control in NEUTRAL.

Turn the ignition switch to the OFF position and remove the key. If LP-Gas equipped, shut off the LP-Gas fuel tank.

Block the wheels and secure the lift truck with tiedowns.

Machine Lifting and Tiedown Information

NOTICE

Improper lifting or tiedowns can allow load to shift and cause injury and/or damage.

-
1. Weight and instructions given herein apply to lift trucks as manufactured by *DOOSAN*.
 2. Use proper rated cables and slings for lifting. Position the crane for level lift truck lift.
 3. Spreader bar widths should be sufficient to prevent contact with the lift truck.
 4. Use the tiedown locations provided for lift truck tiedown.

Check the state and local laws governing weight, width and length of a load.

Contact your *DOOSAN* Lift Truck dealer for shipping instructions for your lift truck.

Towing Information

WARNING

Personal injury or death could result when towing a disabled lift truck incorrectly.

Block the lift truck wheels to prevent movement before releasing the brakes. The lift truck can roll free if it is not blocked.

Follow the recommendations below, to properly perform the towing procedure.

These towing instructions are for moving a disabled lift truck a short distance, at low speed, no faster than 2 km/h (1.2 mph), to a convenient location for repair. These instructions are for emergencies only. Always haul the lift truck if long distance moving is required.

Shield must be provided on the towing lift truck to protect the operator if the tow line or bar should break.

Do not allow riders on the lift truck being towed unless the operator can control the steering and/or braking.

Before towing, make sure the tow line or bar is in good condition and has enough strength for the towing situation involved. Use a towing line or bar with a strength of at least 1.5 times the gross weight of the towing lift truck for a disabled lift truck stuck in the mud or when towing on a grade.

Keep the tow line angle to a minimum. Do not exceed a 30° angle from the straight ahead position. Connect the tow line as low as possible on the lift truck that is being towed.

Quick lift truck movement could overload the tow line or bar and cause it to break. Gradual and smooth lift truck movement will work better.

Normally, the towing lift truck should be as large as the disabled lift truck. Satisfy yourself that the towing lift truck has enough brake capacity, weight and power, to control both lift trucks for the grade and the distance involved.

To provide sufficient control and braking when moving a disabled lift truck downhill, a larger towing lift truck or additional lift trucks connected to the rear could be required. This will prevent uncontrolled rolling.

The different situation requirements cannot be given as minimal towing lift truck capacity is required on smooth level surfaces to maximum on inclines or poor surface conditions.

Consult your *DOOSAN* Lift Truck dealer for towing a disabled lift truck.



1. Release the parking brake.

NOTICE

Release the parking brake to prevent excessive wear and damage to the parking brake system.

2. Check that the service brake pedal is released.
3. Key switch is in the OFF position.
4. Direction control lever is in neutral.
5. Fasten the tow bar to the lift truck.
6. Remove the wheel blocks. Tow the lift truck slowly. Do not tow any faster than 2 km/h (1.2 mph).

WARNING

Be sure all necessary repairs and adjustments have been made before a lift truck that has been towed to a service area is put back into operation.

Inspection, Maintenance and Repair of Lift Truck Forks

The following section gives practical guidelines for inspection, maintenance and repair of lift truck forks. It also provides general information on the design and application of forks and the common cause of fork failures.

Lift truck forks can be dangerously weakened by improper repair or modification. They can also be damaged by the cumulative effects of age, abrasion, corrosion, overloading and misuse.

A fork failure during use can cause damage to the equipment and the load. A fork failure can also cause serious injury.

A good fork inspection and maintenance program along with the proper application can be very effective in preventing sudden failures on the job.

Repairs and modifications should be done only by the fork manufacturer or a qualified technician who knows the material used and the required welding and heat treatment process.

Users should evaluate the economics of returning the forks to the manufacturer for repairs or purchasing new forks. This will vary depending on many factors including the size and type of fork.

Forks should be properly sized to the weight and length of the loads, and to the size of the machine on which they are used. The general practice is to use a fork size such that the combined rated capacity of the number of forks used is equal to or greater than the "Standard(or rated) Capacity" of the lift truck.

The individual load rating, in most cases, will be stamped on the fork in a readily visible area. This is generally on the top or side of the fork shank.

- A fork rated at 1500 pounds at 24 inch load center will be stamped 1500X24.
- A fork rated at 2000 kg at 600 mm load center will be stamped 2000X600.

The manufacturer identification and year and date of manufacture is also usually shown.

Some countries have standards or regulations which apply specifically to the inspection and repair of forks.

Users may also refer to the International Organization For Standardization - ISO Technical Report 5057 - Inspection and Repair of Fork Arms and ISO Standard 2330 - Fork Arms-Technical Characteristics and Testing.

While there are no specific standards or regulations in the United States, users should be familiar with the requirements for inspection and maintenance of lift trucks as provided by the 29 Code Federal Register 1910.178 Powered Industrial Truck, and ANSI/ASME Safety Standard(s) B56.1, B56.5 or B56.6 as applicable to the type of machine(s) in use.

Environment Protection

When servicing this lift truck, use an authorized servicing area and an approved container to collect coolant, oil, fuel, grease, electrolyte and any other potential environmental pollutant before any lines, fittings or related items are disconnected or removed. After servicing, dispose of those materials in an authorized place and container. When cleaning the lift truck, be sure to use an authorized area.

Causes of Fork Failure

Improper Modification or Repair

Fork failure can occur as a result of a field modification involving welding, flame cutting or other similar processes which affect the heat treatment and reduces the strength of the fork.

In most cases, specific processes and techniques are also required to achieve proper welding of the particular alloy steels involved. Critical areas most likely to be affected by improper processing are the heel section, the mounting components and the fork tip.

Bent or Twisted Forks

Forks can be bent out of shape by extreme overloading, glancing blows against walls or other solid objects or using the fork tip as a pry bar.

Bent or twisted forks are much more likely to break and cause damage or injury. They should be removed from service immediately.

Fatigue

Parts which are subjected to repeated or fluctuating loads can fail after a large number of loading cycles even though the maximum stress was below the static strength of the part.

The first sign of a fatigue failure is usually a crack which starts in an area of high stress concentration. This is usually in the heel section or on the fork mounting.

As the crack progresses under repetitive load cycling, the load bearing cross section of the remaining metal is decreased in size until it becomes insufficient to support the load and complete failure occurs.

Fatigue failure is the most common mode of fork failure. It is also one which can be anticipated and prevented by recognizing the conditions which lead up to the failure and by removing the fork service prior to failing.

- **Repetitive Overloading**

Repetitive cycling of loads which exceeds the fatigue strength of the material can lead to fatigue failure. The overload could be caused by loads in excess of the rated fork capacity and by use of the forks tips as pry bars. Also, by handling loads in a manner which causes the fork tips to spread and the forks to twist laterally about their mountings.

- **Wear**

Forks are constantly subjected to abrasion as they slide on floors and loads. The thickness of the fork blade is gradually reduced to the point where it may not be capable of handling the load for which it was designed.

- **Stress Risers**

Scratches, nicks and corrosion are points of high stress concentration where cracks can develop. These cracks can progress under repetitive loading in a typical mode of fatigue failure.

Overloading

Extreme overloading can cause permanent bending or immediate failure of the forks. Using forks of less capacity than the load or lift truck when lifting loads and using forks in a manner for which they were not designed are some common causes of overloading.

Fork Inspection



Establish a daily and 12 month inspection routine by keeping a record for the forks on each lift truck.

Initial information should include the machine serial number on each the forks are used, the fork manufacturer, type, original section size, original length and capacity. Also list any special characteristics specified in the fork design.

Record the date and results of each inspection, making sure the following information is included.

- Actual wear conditions, such as percent of original blade thickness remaining.
- Any damage, failure or deformation which might impair the use of the truck.
- Note any repairs or maintenance.

An ongoing record of this information will help in identifying proper inspection intervals for each operation, in identifying and solving problem areas and in anticipating time for replacement of the forks.

First Installation

1. Inspect forks to ensure they are the correct size for the truck on which they will be used. Make sure they are the correct length and type for the loads to be handled.

If the forks have been previously used, perform the "12 Month Inspection".

If the forks are rusted, see "Maintenance and Repair".

2. Make sure fork blades are level to each other within acceptable tolerances. See "Forks, Step 4," in the "2000 Service Hours or Yearly" in "Maintenance Intervals"
3. Make sure positioning lock is in place and working. Lock forks in position before using truck. See "Forks, Step 7" in the "2000 Service Hours or Yearly" in "Maintenance Intervals".

Daily Inspection

1. Visually inspect forks for cracks, especially in the heel section, around the mounting brackets, and all weld areas. Inspect for broken or jagged fork tips, bent or twisted blades and shanks.
2. Make sure positioning lock is in place and working. Lock the forks in position before using the truck. See "2000 Service Hours or Yearly" in "Maintenance Intervals".
3. Remove all defective forks from service.

12 Months Inspection

Forks should be inspected, at a minimum, every 12 months. If the truck is being used in a multi-shift or heavy duty operation, they should be checked every six months. See "Forks" in the "2000 Service Hours or Yearly" in "Maintenance Intervals."

Maintenance and Repair

1. Repair forks only in accordance with the manufacturer's recommendations.

Most repairs or modifications should be done only by the original manufacturer of the forks or an expert knowledgeable of the materials, design, welding and heat treatment process.

2. The following repairs or modifications SHOULD NOT be attempted.

- Flame cutting holes or cutouts in fork blades.
- Welding on brackets or new mounting hangers.
- Repairing cracks or other damage by welding.
- Bending or resetting.

3. The following repairs MAY be performed.

- Forks may be sanded or lightly ground, to remove rust, corrosion or minor defects from the surfaces.
- Heel sections may be ground with a carbon stone to remove minor surface cracks or defects. Polish the inside radius of the heel section to increase the fatigue life of the fork. Always grind or polish in the direction of the blade and shank length.
- Repair or replace the positioning locks on hook type forks.
- Repair or replace most fork retention devices used with other fork types.

4. A fork should be load tested before being returned to service on completion of repairs authorized and done in accordance with the manufacturer's recommendations.

Most manufacturers and standards require the repaired fork to be tested with a load 2.5 times the specified capacity and at the load center marked on the fork arm.

With the fork restrained in the same manner as its mounting on the lift truck, apply the test load twice, gradually and without shock. Maintain the test for 30 seconds each time.

Check the fork arm before and after the second application of the test load. It shall not show any permanent deformation.

Consult the fork manufacturer for further information as may be applicable to the specific fork involved.

Testing is not required for repairs to the positioning lock or the markings.

Tire Inflation Information

Tire Inflation

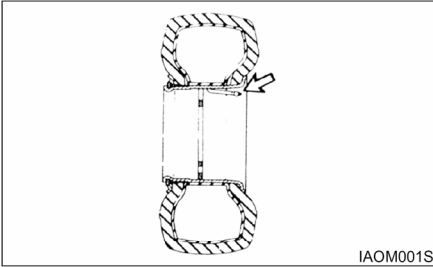

⚠ WARNING

Personal injury or death could result when tires are inflated incorrectly.

Use a self - attaching inflation chuck and stand behind the tread when inflating a tire.

Proper inflation equipment, and training in using the equipment, are necessary to avoid overinflation. A tire blowout or rim failure can result from improper or misused equipment.

NOTICE

Set the tire inflation equipment regulator at no more than 140 kPa (20 psi) over the recommended tire pressure.

Tire Shipping Pressure

The tire inflation pressures shown in the following chart are cold inflation shipping pressures.

Size	Ply Rating or Strength Index	Shipping Pressure	
		kPa	psi
7.00X12 Steer	12	860	125
8.25X15 Drive	14	825	120
300X15 Drive	18	785	115
7.50X16 Drive dual	12	760	110

¹ Standard tire, ply rating and inflation pressures.

The operating inflation pressure is based on the weight of a ready - to - work machine without attachments, at rated payload, and in average operating conditions. Pressures for each application may vary and should always be obtained from your tire supplier.

NOTE: Fill tires to the recommended pressures listed ± 35 kPa (5 psi). Tires can be filled with nitrogen.

Tire Inflation Pressures Adjustment

A tire inflation in a warm shop area, 18° to 21°C (65° to 70°F), will be under inflated if the lift truck works in freezing temperatures. Low pressure shortens the life of a tire.

Torque Specifications

Metric Hardware

Most of the nuts, bolts, studs, and threaded holes in your lift truck are metric. In this manual we provide specifications in both metric and U.S. customary measurement. Always replace metric hardware with metric hardware. See the parts books for proper replacement.

NOTE: For proper fit, use only metric tools on metric hardware. Non-metric tools might slip and cause injury.

Torque for Standard Hose Clamps – Worm Drive

NOTICE

The chart below gives the torques for initial installation of hose clamps on new hose and for reassembly or retightening of hose clamps on existing hose.

Clamp Width	Initial Installation Torque On New Hose	
	N•m ¹	lb•in
16 mm (.625 in)	7.5 ± 0.5	65 ± 5
13.5 mm (.531 in)	4.5 ± 0.5	40 ± 5
8 mm (.312 in)	0.9 ± 0.2	8 ± 2
Clamp Width	Reassembly Or Retightening Torque	
	N•m ¹	lb•in
16 mm (.625 in)	4.5 ± 0.5	40 ± 5
13.5 mm (.531 in)	3.0 ± 0.5	25 ± 5
8 mm (.312 in)	0.7 ± 0.2	6 ± 2

¹ 1 Newton meter (N•m) is approximately the same as 0.1 kg•m.

Torque for Standard Bolts, Nuts, and Taperlock Studs

NOTICE

The two charts below give general torques for bolts, nuts, and taperlock studs of SAE Grade 5 or better quality.

Torques for Bolts and Nuts With Standard Threads

Thread Size Inch	Standard Nut and Bolt Torque	
	N•m ¹	lb•ft
1/4	12 ± 4	9 ± 3
5/16	25 ± 7	18 ± 5
3/8	45 ± 7	33 ± 5
7/16	70 ± 15	50 ± 11
1/2	100 ± 15	75 ± 11
9/16	150 ± 20	110 ± 15
5/8	200 ± 25	150 ± 18
3/4	360 ± 50	270 ± 37
7/8	570 ± 80	420 ± 60
1	875 ± 100	640 ± 75
1 1/8	1100 ± 150	820 ± 110
1 1/4	1350 ± 175	1000 ± 130
1 3/8	1600 ± 200	1180 ± 150
1 1/2	2000 ± 275	1480 ± 200

¹ 1 Newton meter (N•m) is approximately the same as 0.1 kg•m.

Torques for Taperlock Studs

Thread Size Inch	Standard Taperlock Stud Torque	
	N•m ¹	lb•ft
1/4	8 ± 3	6 ± 2
5/16	17 ± 5	13 ± 4
3/8	35 ± 5	26 ± 4
7/16	45 ± 10	33 ± 7
1/2	65 ± 10	48 ± 7
5/8	110 ± 20	80 ± 15
3/4	170 ± 30	125 ± 22
7/8	260 ± 40	190 ± 30
1	400 ± 60	300 ± 45
1 1/8	500 ± 700	370 ± 50
1 1/4	650 ± 80	480 ± 60
1 3/8	750 ± 90	550 ± 65
1 1/2	870 ± 100	640 ± 75

¹ 1 Newton meter (N•m) is approximately the same as 0.1 kg•m.

Torque for Metric Fasteners

NOTICE

Be very careful never to mix metric with U.S. customary (standard) fasteners. Mismatched or incorrect fasteners will cause lift truck damage or malfunction and may even result in personal injury.

Original fasteners removed from the lift truck should be saved for reassembly whenever possible. If new fasteners are needed, they must be of the same size and grade as the ones that are being replaced.

The material strength identification is usually shown on the bolt head by numbers (8.8, 10.9, etc.). This chart gives standard torques for bolts and nuts with Grade 8.8.

NOTE: Metric hardware must be replaced with metric hardware. Check parts book.

Metric ISO² Tread

Thread Size Metric	Standard Torque	
	N•m ¹	lb•ft
M6	12 ± 4	9 ± 3
M8	25 ± 7	18 ± 5
M10	55 ± 10	41 ± 7
M12	95 ± 15	70 ± 11
M14	150 ± 20	110 ± 15
M16	220 ± 30	160 ± 22
M20	450 ± 70	330 ± 50
M24	775 ± 100	570 ± 75
M30	1600 ± 200	1180 ± 150
M36	2700 ± 400	2000 ± 300

¹ 1 Newton meter (N•m) is approximately the same as 0.1 kg•m.

² ISO - International Standards Organization.

Cooling System Specifications

Coolant Information

NOTE: The following information is generic and valid for lift trucks.

Engine operating temperatures have increased to improve engine efficiency. This means proper cooling system maintenance is especially important. Overheating, overcooling, pitting, cavitation erosion, cracked heads, piston seizures, and plugged radiators are classic cooling system failures. In fact, coolant is as important as the quality of fuel and lubricating oil.

Filling at over 20 liters (5 U.S. gallons) per minute can cause air pockets in the cooling system.

After draining and refilling the cooling system, operate the engine with the radiator cap removed until the coolant reaches normal operating temperature and the coolant level stabilizes. Add coolant as necessary to fill the system to the proper level.

Never operate without a thermostat in the cooling system. Cooling system problems can arise without a thermostat.

NOTICE

DOOSAN recommends that the coolant mixture contain 50% commercially available automotive antifreeze, and 50% water.

The coolant mix with concentration of antifreeze smaller than 30% does not provide sufficient corrosion protection. Concentrations over 60% adversely affect freeze protection and heat transfer rates.

Never add coolant to an overheated engine, engine damage can result. Allow the engine to cool first.

If the machine is to be stored in, or shipped to, an area with freezing temperatures, the cooling system must be protected to the lowest expected outside (ambient) temperature.

The engine cooling system is normally protected to -28°C(-20°F) with antifreeze, when shipped from the factory unless special requirements are defined.

Check the specific gravity of the coolant solution frequently in cold weather to ensure adequate protection.

Clean the cooling system if it is contaminated, the engine overheats or foaming is observed in the radiator.

Old coolant should be drained, the system cleaned and new coolant added every 2000 service hours or yearly.

Refer to topic, "Cooling System - Clean, Change" in Every 2000 Service Hours or Yearly section.

Coolant Water

Hard water, or water with high levels of calcium and magnesium ions, encourages the formation of insoluble chemical compounds by combining with cooling system additives such as silicates and phosphates.

The tendency of silicates and phosphates to precipitate out-of-solution increases with increasing water hardness. Hard water, or water with high levels of calcium and magnesium ions encourages the formation of insoluble chemicals, especially after a number of heating and cooling cycles.

DOOSAN prefers the use of distilled water or deionized water to reduce the potential and severity of chemical insolubility.

Acceptable Water	
Water Content	Limits (PPM)
Chlorides (Cl)	50 maximum
Sulfates (SO ₄)	50 maximum
Total hardness	80mg/l
Total solids	250 maximum
PH	6.0 to 8.0

ppm = parts per million

Using water that meets the minimum acceptable water requirement may not prevent drop-out of these chemical compounds totally, but should minimize the rate to acceptable levels.

Antifreeze

NOTICE

DOOSAN recommends using automotive antifreeze suitable for gasoline engines having aluminum alloy parts. Antifreeze of poor quality will cause corrosion of the cooling system, and thus always use automotive antifreeze prepared by a reliable maker, and never use it mixed with antifreeze of different brand.

DOOSAN recommends that the coolant mix contain 50% commercially available automotive antifreeze, or equivalent and acceptable water to maintain and adequate water pump cavitation temperature for efficient water pump performance.

Premix coolant solution to provide protection to the lowest expected outside (ambient) temperature. Pure undiluted antifreeze will freeze at -23°C (-10°F).

Use a greater concentration (above 50%) of commercially available automotive antifreeze only as needed for anticipated outside (ambient) temperatures. Do not exceed the recommendations, provided with the commercially available automotive antifreezes, regarding the coolant mixture of antifreeze to water.

Make proper antifreeze additions.

Adding pure antifreeze as a makeup solution for cooling system top-up is an unacceptable practice. It increases the concentration of antifreeze in the cooling system which increase the concentration of dissolved solids and undissolved chemical inhibitors in the cooling system. Add antifreeze mixed with water to the same freeze protection as your cooling system.

Use the chart below to assist in determining the concentration of antifreeze to use.

Antifreeze Concentrations	
Protection Temperature	Concentration
Protection to -15°C (5°F)	30% antifreeze and 70% water
Protection to -23°C (-10°F)	40% antifreeze and 60% water
Protection to -37°C (-34°F)	50% antifreeze and 50% water
Protection to -51°C (-60°F)	60% antifreeze and 40% water

Fuel Specifications

General Fuel Information

Use only fuel as recommended in this section.

NOTICE

Fill the fuel tank at the end of each day of operation to drive out moisture laden air and to prevent condensation. Maintain a constant level near the top of the day tank to avoid drawing moisture into the tank as the level decreases. Do not fill the tank to the top. Fuel expands as it gets warm and can overflow.

Do not fill the fuel filters with fuel before installing them. Contaminated fuel will cause accelerated wear to the fuel system parts.

Drain the water and sediment from main fuel storage tank before it is refilled. This will help prevent water and/or sediment from being pumped from the fuel storage tank into the engine fuel tank.

Diesel Specifications

Fuel Types

DOOSAN Diesel Engines have the ability to burn a wide variety of fuels. These fuels are divided into two general groups, preferred and permissible.

The Preferred Fuels provide maximum engine service life and performance. They are distillate fuels. They are commonly called diesel fuel, MDO diesel, furnace oil, gas oil or kerosene (for cold weather operation).

Experience has proven that distillate fuels meeting the following basic specifications will result in optimum engine performance and durability.

DOOSAN strongly encourages the use of fuels that meet the Preferred Fuels specification.

The permissible fuels are crude oils or blended fuels. Use of these fuels can result in higher maintenance costs and reduced engine service life.

Crude oil is used to describe oils/fuels that are not refined and are in the original state as when pumped from the ground. Certain types of crude oils can be burned in DOOSAN Engines.

PREFERRED DISTILLATE FUEL FOR DIESEL ENGINES

Specifications	Requirements*
Aromatics (AST D1319)	35% Max.
Ash (ASTM D482)	0.02% Weight Max.
Cetane Number (ASTM D613)	35 Min. for 45 Max. 40 Min. for DI Engines
Cloud Point (ASTM D97)	Not Above Lowest Expected Ambient Temperature
Gravity API (ASTM D287)	30 Min. and 45 Max.
Pour Point (ASTM D97)	6°C (10°F) Below Ambient Min.
Sulfur (ASTM D2788, D3605 or D1552)	0.5% Max. (See Sulfur Topic)
Viscosity, Kinematic @ 38°C (100°F) (ASTM D445)	20.0 cSt Max. 1.4 cSt Min.
Water & Sediment (ASTM D1796)	0.01% Max.

*As delivered to fuel system

Fuel Sulfur Content

The percentage of sulfur in the fuel will affect the engine oil recommendations. Fuel sulfur is chemically changed during combustion to form both sulfurous and sulfuric acid. These acids chemically attack metal surfaces and cause corrosive wear.

Certain additives used in lubricating oils contain alkaline compounds that are formulated to neutralize these acids. The measure of this reserve alkalinity in lubricating oil is known as its Total Base Number (TBN). TBN is essential to neutralize the acids from combustion gases and to minimize corrosive wear.

Any API classification performance of oil should have sufficient TBN for fuels with less than 0.5% sulfur. For fuels with 0.5% to 1.5% sulfur by weight, engine oil must have a TBN of 20 times the percentage of fuel sulfur as measured by the ASTM (American Society of Testing Materials) D-2896 method. (ASTM D-2896 can normally be found at your local technological society, library or college).

DOOSAN recommends infrared analysis (in conjunction with wear metal analysis) of used oil in determining the effectiveness of oil TBN and acid neutralization.

For fuel with sulfur exceeding 1.5% by weight, use oil with a TBN of 30 and reduce the oil change interval by one half. Also, infrared analysis and wear metal analysis should be used to establish oil change intervals.

Periodically request fuel sulfur content information from your fuel supplier. Fuel sulfur content can change with each bulk delivery.

LP-Gas Specifications

LP-Gas is "Liquefied Petroleum Gas". The exact composition of LP-Gas varies slightly between different parts of the country and different refineries.

HD5 is recommended for *DOOSAN* forklift trucks. Remember LP-Gas is heavier than air and will sink to the lowest spot possible. Avoid areas near floor drains or lubrication pits where escaped fuel may collect.

Composition of HD5	
Propane (C ₃ H ₈)	90.0 %
Propylene	up to 5 %
Butane (C ₄ H ₁₀)	2.0 %
iso-Butane	1.5 %
Methane (CH ₄)	1.5 %
Total	100 %

Lubricant Specifications

Lubricant Information

Certain abbreviations follow Society of Automotive Engineers (SAE) J754 nomenclature and some classifications follow SAE J183 abbreviations.

The MIL specifications are U.S.A. Military Specifications.

The recommended oil viscosities can be found in the Lubricant Viscosities chart in this publication.

Grease is classified by the National Lubricating Grease Institute (NLGI) based on ASTM D217-68 Worked Penetration characteristics which are given a defined consistency number.

Engine Oil (DEO and EO)

The following oil specifications provide guidelines for the selection of commercial products :

- Gasoline/LP-Gas Engine : API SJ
- TIER I Diesel Engine (DB58 E/G)
: API CD Grade or higher, ACEA E2
- TIER II Diesel Engine (DB58S E/G)
: API CH-4 Grade, ACEA E5

NOTICE

Failure to follow the oil recommendations can cause shortened engine life due to carbon deposits or excessive wear.

Consult the EMA Lubricating Oils Data Book for a listing of oil brands.

NOTE: The percentage of sulfur in the fuel will affect the engine oil recommendations. For fuel sulfur effects, the Infrared Analysis or the ASTM D2896 procedure can be used to evaluate the residual neutralization properties of an engine oil. The sulfur products formation depends on the fuel sulfur content, oil formulation, crankcase blowby, engine operating conditions and ambient temperature.

Hydraulic Oil (HYDO)

The following commercial classifications can be used in the hydraulic system.

- | | |
|---------------------|-----------|
| • ISO 6743/4 | HM |
| • AFNOR NFE 48-603 | HM |
| • DIN 51524 TEIL 2 | H-LP |
| • HAGGLUNDS DENISON | HFO-HF2 |
| • CINCINNATI | P68,69,70 |

Viscosity : ISO VG 32

Industrial premium hydraulic oils that have passed the Vickers vane pump test (35VQ25). These oils should have antiwear, antifoam, antitrust and antioxidation additives for heavy duty use as stated by the oil supplier. ISO viscosity grade of 32 would normally be selected.

NOTICE

Make-up oil added to the hydraulic tanks must mix with the oil already in the systems. Use only petroleum products unless the systems are equipped for use with special products. If the hydraulic oil becomes cloudy, water or air is entering the system. Water or air in the system will cause pump failure. Drain the fluid, retighten all hydraulic suction line clamps, purge and refill the system. Consult your DOOSAN Lift Truck dealer for purging instructions.

Transmission Oil (TDTO)

NOTICE

This oil is formulated for transmissions and drive trains only, and should not be used in engines. Shortened engine life will result.

NOTE: Multi-grade oils are not blended by *DOOSAN* for use in transmissions. Multi-grade oils which use high molecular weight polymers as viscosity index improvers lose their viscosity effectiveness by permanent and temporary shear of the viscosity index improver and therefore, are not recommended for transmission and drive train compartments.

NOTE: Failure to follow this recommendation can cause shortened transmission life due to material incompatibility, inadequate frictional requirements for disk materials and/or excessive gear wear.

Select the oil that meets the following specification.

- GM DEXRON III
- FORD MERCON V

Drive Axle Oil

NOTE: Failure to follow the recommendation will cause shortened life due to excessive gear wear.

Shoe Brake

Select oil that meets below specifications.

- API GL-5
- MIL-L-2105 C, D

Gear Oil offers maximum protection against the scoring and pitting of gear teeth and rolling element bearings.

Gear Oil can also provide excellent stability under high temperature conditions and has superior low temperature performance. It will also give protection against rust and corrosion.

Oil Cooled Disc Brake (OCDB)

Select oil that meets below specifications.

: Universal Transmission Tractor Oil (UTTO)

The following UTTO products are authorized for use.

Supplier	Product Name
TOTAL	TRANSMISSION MP
MOBIL	MOBILFLUID 424

Lubricant Viscosities and Refill Capacities

Lubricant Viscosities

Lubricant Viscosities for Ambient (Outside) Temperatures						
Compartment or System	Oil Viscosities	°C		°F		
		Min	Max	Min	Max	
Engine Crankcase (LP-Gas) and Lift Chains API SJ	SAE 10W30	-20	+40	-4	+104	
	SAE 5W30	-30	+30	-22	+86	
Engine Crankcase (Diesel) API CH4 or ACEA E5	SAE 15W40	-15	+50	+5	+122	
Power Shift Transmission DEXRON III	DEXRON III	-20	+50	-4	+122	
Hydraulic and Power Steering System ISO 6743/4 HM	ISO VG32	-20	+30	-4	+86	
	ISO VG46	-10	+40	+14	+104	
	ISO VG68	0	+50	+32	+122	
Drive Axle Housing	Shoe Brake API GL-5	SAE 80W90	-20	+50	-4	+122
	Disc Brake (OCDB) UTTO	UTTO	-20	+80	-4	+176
Brake Reservoir (Only for OCDB) ISO 6743/4HM	ISO VG32	-20	+30	-4	+86	
	ISO VG46	-10	+40	+14	+104	
	ISO VG68	0	+50	+32	+122	

The SAE grade number indicates the viscosity of oil. A proper SAE grade number should be selected according to ambient temperature.

Refill Capacities

Refill Capacities-(Approximate)			
Compartment or System		Liters	U.S. Gal.
Engine Crankcase w/Filter LP-Gas		4.3	1.1
Engine Crankcase w/Filter Diesel	TIER I (DB58)	14.5	3.83
	TIER II (DB58S)	20.5	5.41
Cooling System w/Coolant Recovery Bottle LP-Gas		19.0	5.0
Cooling System w/Coolant Recovery Bottle DB58 Diesel		23	6.1
Fuel Tank - Diesel		90.0	23.8
Power Shift Transmission		13.0	3.4
Hydraulic & Power Steering System		73.0	19.3
Drive Axle	Shoe Brake	11.0	2.9
	Disc Brake (OCDB)	14.0	3.7
Brake Reservoir (Only for OCDB)		1.0	0.3

Maintenance Intervals

NOTICE

All maintenance and repair, except Every 10 Service Hours or Daily, on the lift truck must be performed by qualified and authorized personnel only.

NOTICE

Careless disposal of waste oil can harm the environment and can be dangerous to persons. Always dispose of waste oil to authorized personnel only.

When Required

Engine Valve Lash (Diesel Engine Only) - Check, Adjust.....	118
Water Separator (Diesel Engine Only) - Drain	118
Test Fuel System for Leaks (LP Engine Only)	119
Priming the Fuel System (Diesel Engine Only).....	120
Seat, Hood Latch & Support Cylinder - Check, Lubricate.....	120
Fuses, Bulbs & Circuit Breaker - Change, Reset.....	121
Fuse Relay (G643E Only)	122
Tires and Wheels - Check, Inspect.....	123
Carriage Roller Extrusion - Check, Adjust.....	124

Every 10 Service Hours or Daily

Inspect Engine for Fluid Leaks.....	125
Engine Oil Level - Check	125
Coolant Level - Check, Clean	125
Air Cleaner Indicator - Check.....	126
Walk - Around Inspection - Inspect	127
Mast Channels – Lubricate.....	128
Transmission Oil Level - Check.....	128

First 50 - 100 Service Hours or a Week

Engine Oil & Filter (Diesel Engine Only) – Change .	129
Transmission Oil, Oil Filter & Strainer - Clean, Change	130
Drive Axle Oil - Check, Clean, Change	132
Parking Brake - Test, Adjust.....	133
First 250 Service Hours or a Month	
Hydraulic Return Filter - Change	135

Every 250 Service Hours or Monthly

Air Intake System - Check, Clean	136
Hydraulic Oil Level - Check	139
Drive Axle Oil Level - Check.....	139
Mast, Carriage, Lift Chains, & Attachments - Check, Lubricate.....	140
Carriage Side Rollers - Lubricate	141
Steering Mechanism - Check, Lubricate	141
Battery Terminal - Clean, Inspect.....	142
Engine Oil & Filter – Change.....	142
Wheel Bolts and Nuts - Inspect	143

Every 500 Service Hours or 3 Months

Belts (Diesel Engine Only) - Check, Adjust.....	144
Mast Hinge Pins – Lubricate	144
Tilt Cylinders - Check, Adjust, Lubricate.....	145
Crosshead Rollers - Inspect.....	146
Carriage Side Rollers Thrust (If Equipped) - Lubricate	146
Carriage Sideshifter (If Equipped) – Lubricate	146
Parking Brake - Test, Adjust.....	147
Circulation Pump Belt (OCDB & LP-Gas Engine Only) - Check, Adjust.....	147
Drive Axle Oil & Strainer (OCDB Only) - Check, Clean, Change	147
Engine Oil & Filter - Change.....	148
Inching & Brake Control shaft - Lubricate	148
Horn & Lights (If Equipped) – Check	148
Inspect Vacuum Lines and Fittings (G643E Engine only)	148
Fuel Trim Valve(FTV) Inspection (G643E Engine only)	149
Inspect Electrical System (G643E Engine only)	149
Overhead Guard – Inspect	149
Steer Suspension - Inspect.....	149

Every 1000 Service Hours or 6 Months

Carburetor (LP - Gas Engine Only) - Adjust, Clean.	150
Fuel Filters - Change.....	150
Air Intake System - Change	151
Inspect Coolant Hoses (LP Engines Only)	151
LP Regulator/Converter Inspection (LP Engine Only)	151
Fuel Lines & Fittings - Check	152
Inspect Mixer Assembly (G643E Engine Only)	152
Inspect Throttle Assembly (G643E Engine Only)	152
Hydraulic Return Filter - Change	152
Air Breather - Change	152
Transmission Oil, Oil Filter & Strainer - Clean, Change	152
Lift Chains - Test, Check, Adjust.....	153
Universal Joint (Diesel Engine Only) - Inspect.....	155

Every 1500 Service Hours or 9 Months

Drive Axle Oil (Shoe Brake Only) - Check, Clean, Change..... 156
Inspect Ignition System (LP-Gas Engine Only)..... 156
Replace Spark Plugs (LP-Gas Engine Only)..... 156
Replace LP Fuel Filter Element (LP-Gas Engine Only) 157
Fuel Filter (LP - Gas Engine Only) 153
Testing Fuel Lock-off Operation (LP-Gas Engine Only) 158

Every 2000 Service Hours or Yearly

Steer Wheel Bearings - Reassemble..... 159
Cooling System - Clean, Change 161
Fork – Inspect 162

Every 2500 Service Hours or 15 Months

Hydraulic Oil - Check, Clean, Change..... 164
Inspect Battery System 165
Checking the TMAP Sensor (G643E Engine Only). 165
Inspect for Intake Leaks (G643E Engine Only)..... 165
Replace PCV Valve and breather element - Change (LP-Gas Engine Only) 165

Every 4500 Service Hours or two Years

Replace Oxygen Sensor (G643E Engine Only)..... 166

Quick Reference to Maintenance Schedule				FIRST	EVERY								
ITEMS	SERVICES	PAGE	When Required	50-100 Service Hours or a Week	250 Service Hours or a Month	10 Service Hours or a Day	250 Service Hours or a Month	500 Service Hours or 3 Months	1000 Service Hours or 6 Months	1500 Service Hours or 9 Months	2000 Service Hours or a Year	2500 Service Hours or 15 Months	4500 Service Hours or 2 Years
Air Breather	Change	152							O				
Air Cleaner Indicator	Check	126				O							
Air Intake System	Check, Clean	136					O						
Air Intake System	Change	151									O		
Battery Terminal	Clean, Inspect	142					O						
Belts(Diesel E/G Only)	Check, Adjust	144						O					
Carburetor(LP-Gas E/G Only)	Adjust, Clean	150							O				
Carriage Roller Extrusion	Adjust, Check	124	O										
Carriage Side Rollers	Lubricate	141					O						
Carriage Sideshifter(If Equipped)	Lubricate	146						O					
Circulation Pump Belt(OCDB & LP-Gas E/G Only)	Check, Adjust	147						O					
Cooling System	Clean, Change	161									O		
Drive Axle Oil	Check, Clean, Change	142		O									
Drive Axle Oil & Strainer(OCDB Only)	Check, Clean, Change	147						O					
Drive Axle Oil(Shoe Brake Only)	Check, Clean, Change	156								O			
Engine Oil & Filter	Change	142, 148					O	O					
Engine Oil & Oil Filter(Diesel E/G Only)	Change	129		O									
Engine Oil Level	Clean, Check	125				O							
Engine Valve Lash(Diesel E/G Only)	Check, Adjust	118	O										
Forks	Inspect	162									O		
Fuel Filter	Change	150								O			
Fuel Lines & Fittings	Check	152									O		
Fuses, Bulbs & Circuit Breaker	Change, Reset	121	O										
Horn & Lights(If Equipped)	Check	148						O					
Hydraulic Oil	Check, Clean, Change	164											
Hydraulic Oil Level	Check	139					O					O	
Hydraulic Return Filter	Change	135, 152			O				O				
Inching & Brake Control Shaft	Lubricate	148						O					
Lift Chains	Test, Check, Adjust	153							O				
Mast Carriage, Lift Chains & Attachments	Check, Lubricate	140					O						
Mast Channels	Lubricate	128				O							
Mast Hinge Pins	Lubricate	144						O					
Overhead Guard	Inspect	149						O					
Oxygen Sensor	Change	166											O
Parking Brake	Test, Adjust	133, 147		O				O					
Replace PCV Valve and breather element (LP-Gas Engine Only)	Change	165										O	
Seat, Hood Latch & Support Cylinder	Check, Lubricate	121	O										
Steer Suspension	Inspect	149						O					
Steer Wheel Bearings	Reassemble	159									O		
Steering Mechanism	Check, Lubricate	141					O						
Tilt Cylinders	Check, Adjust, Lubricate	145						O					
Tires & Wheels	Inspect, Check	123											
Transmission Oil, Oil Filter & Strainer	Clean, Change	130, 152		O					O				
Universal Joint(Diesel E/G Only)	Inspect	155							O				
Walk-Around Inspection	Inspect	127											
Water Separator(Diesel E/G Only)	Drain	118	O										
Wheel Bolts & Nuts	Inspect	143					O						

When Required

You must read and understand the warnings and instructions contained in the Safety section of this manual, before performing any operation or maintenance procedures.

Engine Valve Lash (Diesel Engine Only) - Check, Adjust

NOTICE

The valve clearances are to be adjusted at the times of the following situations.

- When the engine is overhauled and the cylinder heads are disassembled.
- When severe noise comes from valve train.
- When the engine is not normally operated even though there is no trouble in the fuel system.

WARNING

To prevent possible injury when adjusting diesel engines, do not use the starter motor to turn the flywheel.

Hot engine components can cause burns. Allow additional time for the engine to cool before measuring valve clearance.

NOTICE

Measure the valve lash with the engine stopped. To obtain an accurate measurement, allow at least 20 minutes for the engine cylinder head and block to cool.

Set the clearance to the nominal appropriate clearance given in the “Valve Clearance Setting” chart shown below.

Valve Clearances		
Engine	Valve	Clearance
5.8 Liter Diesel	Exhaust Valves	.40mm(.16in)
	Intake Valves	.40mm(.16in)

Refer to the “Service Manual” for the complete valve adjustment procedure.

NOTE: In case of LPG Engine, no valve adjustment is necessary.

Water Separator (Diesel Engine Only) - Drain

The water separator acts as a water trap to separate the water from the diesel fuel. If the engine fails to start or there is a loss of power, it may have to be drained.

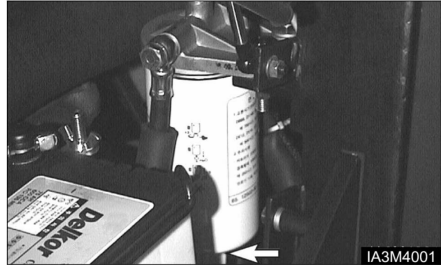

Remove plug at the bottom of the separator bowl and allow the water to drain and then install plug.

Test Fuel System for Leaks (LP Engine Only)

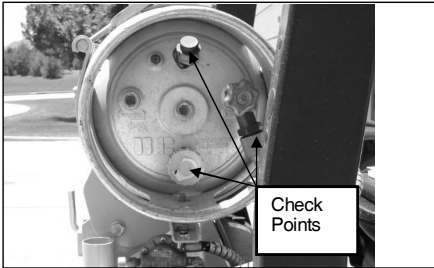

1. Obtain a leak check squirt bottle or pump spray bottle.
2. Fill the bottle with an approved leak check solution.
3. Spray a generous amount of the solution on the fuel system fuel lines and connections, starting at the storage container.
4. Wait approximately 15-60 seconds then perform a visual inspection of the fuel system. Leaks will cause the solution to bubble.
5. Repair any leaks before continuing.
6. Crank the engine through several revolutions. This will energize the fuel lock-off and allow fuel to flow to the pressure regulator/converter. Apply additional leak check solution to the regulator/converter fuel connections and housing. Repeat leak inspection as listed above.
7. Repair any fuel leaks before continuing.

⚠ WARNING

Prior to any service or maintenance activity, Test Fuel System for Leaks

Priming the Fuel System (Diesel Engine Only)

Bleeding the Fuel System

After changing the fuel filter, or after having serviced any part of the fuel system, make sure that the air is bled from the system.

1. Release the feed pump cap (1) on the injection pump.
2. Release an air bleed nut (2) on the injection pump.
3. Operate feed pump vertical until completely remove an air.
4. Tighten air bleed nut (2).
5. Make sure to check leakage of injection pump & filter after operating feed pump many times.

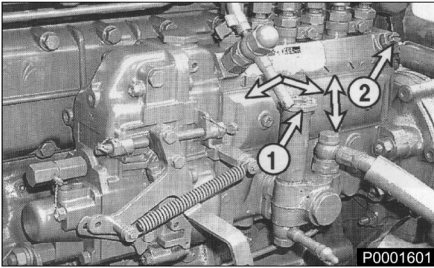

Seat, Hood Latch & Support Cylinder - Check, Lubricate



1. Check the operation of the seat adjuster rod. Make sure that the seat slides freely on its track. Lightly oil the seat slider tracks if necessary.



2. Push the lever down to raise the hood and seat assembly. Make certain the support cylinder will hold the hood open.



3. Lightly oil the hood latch mechanism and the rod for the hood support cylinder.

Fuses, Bulbs & Circuit Breaker - Change, Reset

Fuses

NOTE: If a fuse filament separates, use only the same type and size fuses for replacement. If the filament in a new fuse separates, have the circuits and instruments checked.

NOTICE

Always replace fuses with ones of the correct ampere rating.



Remove the front cover from the fuse box. The fuses are located under the cowl.



Fuse - Protects an electrical circuit from an overload. Opens (filament separates) if an overload occurs.

Fuse Box (Open)

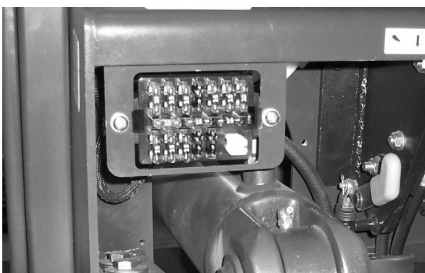

Typical Example

10	HORN	OPTION (BAT +)	HEAD LAMP CLEARANCE LAMP + PARKINGS ALARM	15A ACC	TURN SIG LAMP STOP LAMP, STROBE	10A START RELAY
15A	INST PANEL GONT, GP - FUEL LOCK	FIR CONT LAMP RELAY	OPTION (IGNITION)			

Fuse Box (Close)

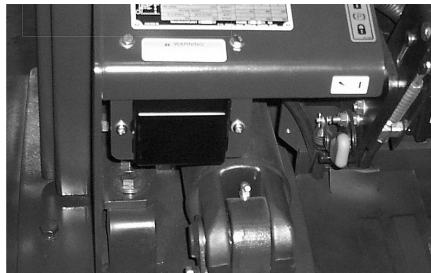

Typical Example

Fuses are identified as follows :

1. Horn - 10 A
2. Head Lamp ,Clearance Lamp, Tail Lamp - 15 A
3. Lamp Relay Coil, Fwd/Rev. Solenoid, Rear Lamp Relay & Back-up Lamp/Alarm - 15 A
4. Instrument Panel, Hour Meter, Preheat Controller, Fuel Shut off Solenoid - 15 A
5. Stop Lamp, Turn Signal Lamp, Strobe Lamp - 15 A
6. Starter Relay - 10 A

Bulbs

Bulbs are identified as follows:

[Diesel Engine]

1. Bulb - head lamp halogen (24V - 55W)
- *2. Bulb - back up (24V - 10W)
- *3. Bulb - turn signal (24V - 25W)
- *4. Bulb - stop & tail (24V - 25/10W)

[LP Gas Engine]

1. Bulb - head lamp halogen (12V - 35W)
- *2. Bulb - back up (12V - 8W)
- *3. Bulb - turn signal (12V - 23W)
- *4. Bulb - stop & tail (12V - 23/8W)

*Optional lamp or light

Fuse & Relay (G643E Only)

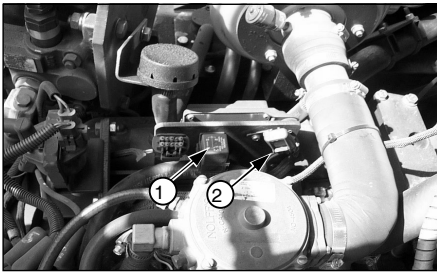

(1) Relay (2) Fuse

Located on top of engine.

Circuit Breaker



1. Raise the hood and seat assembly. Make sure the support cylinder securely holds the hood open.

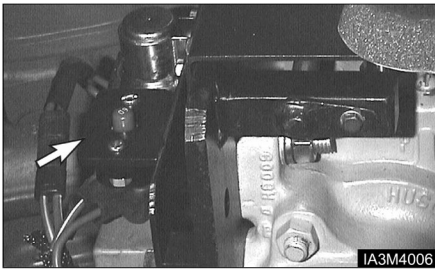

Typical Example Diesel Engine Truck

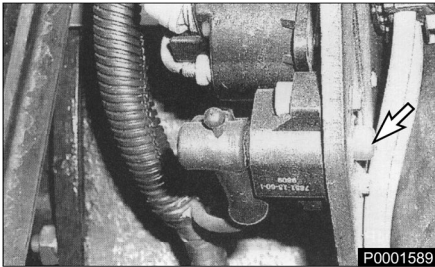

Typical Example LP-Gas Engine Truck

2. The main circuit breaker is located on the rear of the support for the controls.

NOTE: To reset circuit breakers push in on the button. The button should stay in if the breaker is reset. If the button will not stay in, or comes out shortly after reset, have the circuits checked.

Tires and Wheels - Check, Inspect



Servicing and changing tires and rims can be dangerous and should be done only by trained personnel using proper tools and procedures.

If correct procedures are not followed while servicing tires and rims, the assemblies could burst with explosive force and cause serious physical injury or death.

Follow carefully the specific information provided by your tire servicing man or dealer.

Check Inflation and Damage

Inspect tires for wear, cuts, gouges and foreign objects. Look for bent rims and correct seating of locking ring.

Check tires for proper inflation. See "Tire Inflation Pressures".

To inflate tires always use a clip-on chuck with a minimum 60 cm (24 inches) length of hose to an in-line valve and gauge.

Always stand behind the tread of the tire, NOT in front of the rim.

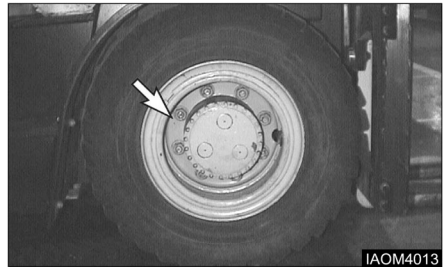

Do NOT reinflate a tire that has been run while flat or underinflated, without first checking to make sure the locking ring on the rim is not damaged and is in the correct position.

When tires are changed, be sure to clean all rim parts and, if necessary, repaint to stop detrimental effects of corrosion. Sand blasting is recommended for removal of rust.

⚠ WARNING

Deflate tire before removing wheel nuts from the truck.

Check all components carefully and replace any cracked, badly worn, damaged and severely rusted or corroded parts with new parts of the same size and type. If there is any doubt, replace with new parts.

Do NOT, under any circumstances, attempt to rework, weld, heat or braze any rim components.

Carriage Roller Extrusion - Check, Adjust

1. Set the mast vertical.
2. Lower the carriage completely.
3. On full free lift and full free triple lift models, the bottom of the inner mast must be flush with the bottom of the stationary mast.

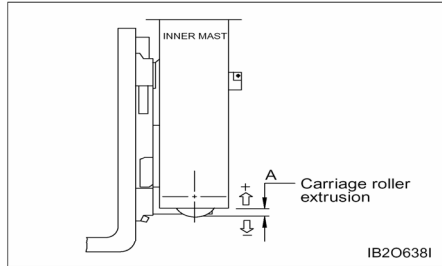

4. Measure the distance from the bottom of the inner upright to the bottom of carriage bearing.
5. The measurement (A) must be as follows in Chart below.

Height of carriage roller extrusion (A) [unit : mm]		
STD mast	FF mast	FFT mast
-7	43	43

Every 10 Service Hours or Daily

You must read and understand the warnings and instructions contained in the Safety section of this manual, before performing any operation or maintenance procedures.

Inspect Engine for Fluid Leaks

1. Start the engine and allow it to reach operating temperatures.
2. Turn the engine off.
3. Inspect the entire engine for oil and/or coolant leaks.
4. Repair as necessary before continuing.

Engine Oil Level - Check

⚠ WARNING

Hot oil and components can cause personal injury. Do not allow hot oil or components to contact skin.

Park the lift truck level, with the forks lowered, parking brake applied, transmission in NEUTRAL and the engine stopped.

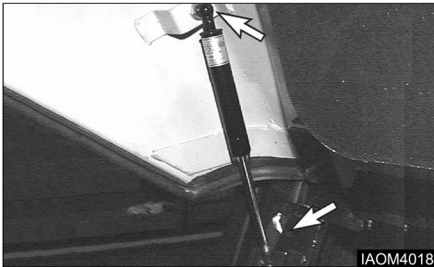

1. Raise the hood and seat assembly. Make certain the support cylinder securely holds the hood open.

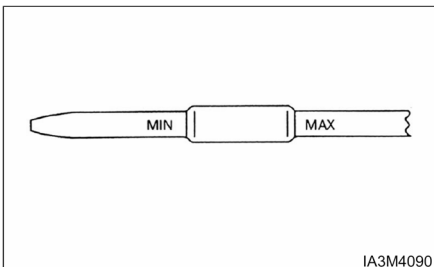

2. Maintain oil level between the MAX. and MIN. marks on the dipstick.

Coolant Level - Check, Clean

Check Coolant Level

⚠ WARNING

At operating temperature, the engine coolant is hot and under pressure.

Steam can cause personal injury.

Check the coolant level only after the engine has been stopped and the filter cap is cool enough to touch with your bare hand.

Remove the filter cap slowly to relieve pressure.

Cooling system conditioner contains alkali. Avoid contact with the skin and eyes to prevent personal injury.



1. Observe the coolant level with engine cold. Maintain coolant level to the proper line on expansion bottle. If the expansion bottle has no coolant, it will be necessary to check coolant at the radiator filter neck.
2. Remove the radiator cap. Fill radiator to the top of the filter neck. Inspect radiator cap. Replace if damaged. Install the radiator cap.

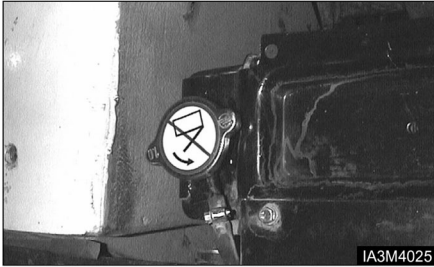

3. Start and run the engine to stabilize the coolant level in the filter neck. If low add coolant until it reaches the top of the filter neck. Install the radiator cap. Observe coolant level in the expansion bottle. If necessary, add coolant to bring the coolant to the appropriate line on the expansion bottle.
4. Stop the engine.
5. Inspect the cooling system for leaks, hose cracks or loose connections.

⚠ WARNING

Pressure air can cause personal injury.

When using pressure air for cleaning, wear a protective face shield, protective clothing and protective shoes.

Maximum air pressure must be less than 205 kPa (30 psi) for cleaning purposes.

6. Blow any dust and lint from the radiator fins.

Air Cleaner Indicator - Check Checking Service Indicator



Typical Example

Diesel Engine Truck

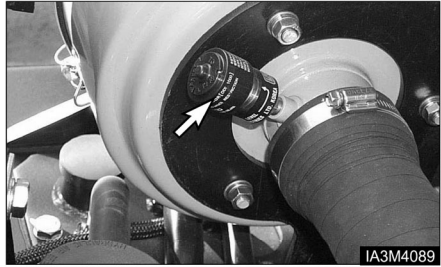

Typical Example

LP-Gas Engine Truck

1. Observe the air cleaner service indicator.
2. Service the air cleaner when the RED band in the service indicator, lock in the visible position. See topic, "Air Intake System - Check, Clean" in "Every 250 Service Hours or Monthly".

NOTE: Service the element more frequently, as required, in severe dust or lint conditions. Also, service it more frequently where the operator is required to wear a respirator.

3. Close hood and seat assembly.

Inspect Acceleration Pedal Operation(G643E Only)

1. Verify foot pedal travel is smooth without sticking.

⚠ WARNING

When the acceleration pedal harness is connected or disconnected, should be worked key OFF condition.

If not, occurred malfunction, can cause the personal injury.

Inspect Engine for Exhaust Leaks

1. Start the engine and allow it to reach operating temperatures.
2. Perform visual inspection of exhaust system.
3. Repair any/all leaks found.

Walk - Around Inspection - Inspect

For maximum service life of the lift truck, make a thorough walk-around inspection.

Look around and under the truck for such items as loose or missing bolts, debris or dirt buildup, fuel, oil or coolant leaks and cut gouged tires.

Have any repairs made and debris removed, as needed.



1. Inspect the tires and wheels for cuts, gouges, foreign objects, inflation pressure and loose or missing bolts.
2. Inspect the mast and lift chains for wear, broken links, pins and loose rollers.
3. Inspect the hydraulic system for leaks, worn hoses or damaged lines.
4. Look for transmission and differential leaks on the lift truck and on the ground.
5. Inspect the operator's compartment for loose items and cleanliness.
6. Inspect the instrument panel for broken gauges and indicator lights.
7. Test the horn and other safety devices for proper operation.



Typical Example

TIER I Diesel Engine Truck

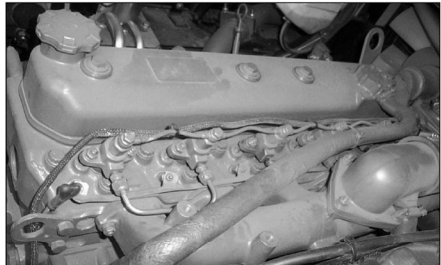

Typical Example

TIER II Diesel Engine Truck

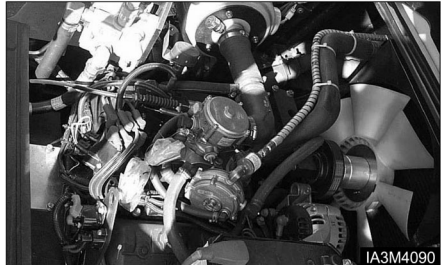

Typical Example

LP-Gas Engine Truck

8. Inspect the cooling system for leaks, worn hoses and debris buildup.
9. Inspect engine compartment for oil, coolant and fuel leaks.

10. Inspect the forks.

- Visually inspect forks for cracks, especially in the heel section, around the mounting brackets, and all weld areas.
- Inspect for broken or jagged fork tips, bent or twisted blades and shanks.
- Make sure positioning lock is in place and working. Lock the forks in position before using the truck. See Step 7 of “ Forks ” in “ Every 2000 Service Hours or Yearly ”
- Remove all defective forks from service.

Mast Channels – Lubricate

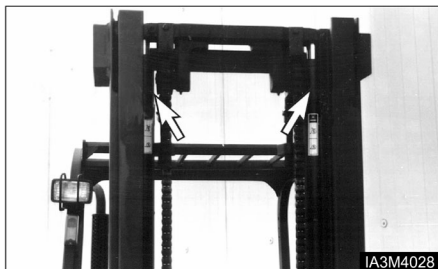

The channels on the roller-type mast require a break-in period. Apply a light film of lubricant on the channels where the rollers ride. This will prevent metal peel until the rollers set a pattern.

Transmission Oil Level - Check



Hot oil and components can cause personal injury. Do not allow hot oil or components to contact skin.

1. Start and operate the lift truck until the engine reaches normal operating temperature.
2. Park the lift truck level with the forks lowered, parking brake applied and the transmission controls in NEUTRAL.
3. With the brake applied and the engine at low idle, shift the directional control lever to forward and then to reverse, to fill the clutches.
4. Shift the direction control lever to the NEUTRAL position.



5. Open the access door in floor plate.
6. Remove the dipstick/filter cap. Observe the oil level.
7. Maintain the oil level between the Min and Max marks on the dipstick/filter cap.

When the oil temperature is 40°C approximately, the cold side mark on the dipstick is applicable. When the oil temperature is 80°C approximately, the hot side mark on the dipstick is applicable.

8. Close the access door in floor plate.
9. Stop the engine.

First 50 - 100 Service Hours or a Week

You must read and understand the warnings and instructions contained in the Safety section of this manual, before performing any operation or maintenance procedures.

Engine Oil & Filter (Diesel Engine Only) – Change

Diesel Engine Crankcase

The percentage of sulfur in the fuel will affect the engine oil recommendations. If the fuel has over 0.5% sulfur content, the CD engine oil must have a TBN of 20 times the percentage of fuel sulfur (TBN as measured by the ASTM D-2896 method). Your oil supplier should be able to furnish the correct oils.

1. Operate lift truck a few minutes to warm oil. Park the lift truck with the forks lowered, parking brake applied, Transmission in neutral and the engine stopped.
2. Raise rear of lift truck off ground and block securely.

WARNING

Hot oil and components can cause personal injury. Do not allow hot oil or components to contact skin.

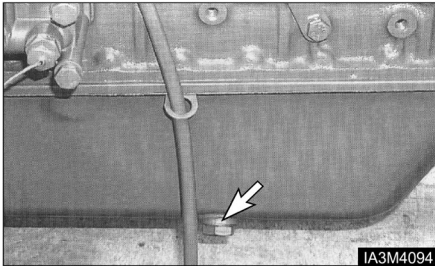

Typical Example

3. Remove the crankcase drain plug and allow oil to drain into a suitable container. Clean and install drain plug.

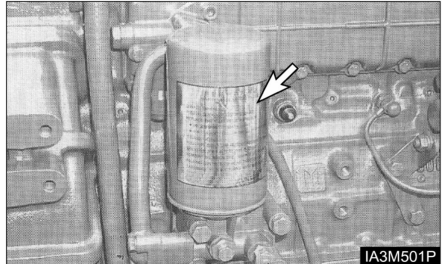

Typical Example

4. Remove and discard oil filter element.
5. Wipe sealing surface of oil filter element mounting base. Make sure the entire gasket is removed.
6. Before installing a new filter element, apply a small amount of clean engine oil to the filter element gasket.
7. Install the new filter element. When the gasket contacts the base, tighten it 3/4 of a turn more. Do not overtighten.
8. Raise the lift truck, remove the blocking and lower the lift truck.
9. Raise the hood and seat assembly.
10. Fill the crankcase. See "Refill Capacities".
11. Start the engine and allow the oil to fill the filter and passages.
12. Check for oil leaks.

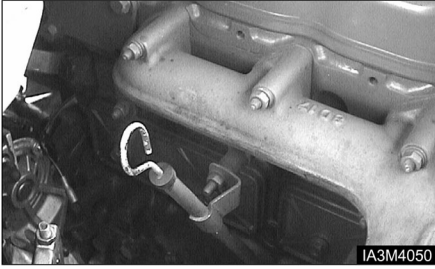

13. Stop the engine and measure the oil level. Maintain the oil level between the MAX. and MIN marks on dip stick.
14. Close hood and seat assembly.

NOTICE

Servicing of the engine oil and oil filter element has large affects on the engine performance as well as the engine life.

Engine oil and filter element must be changed after the first 50 hours.

Transmission Oil, Oil Filter & Strainer - Clean, Change

⚠ WARNING

Hot oil and components can cause personal injury. Do not allow hot oil or components to contact skin.

Park the lift truck level, with the forks lowered, parking brake engaged, transmission in NEUTRAL and the engine stopped.

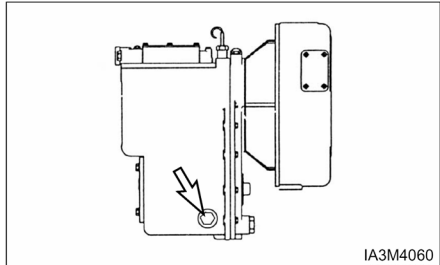

1. Remove the drain plug, spring and strainer. Allow the oil to drain.

NOTICE

Careless disposal of waste oil can harm the environment and can be dangerous to persons.

Always dispose of waste oil to authorized and licensed personnel only.

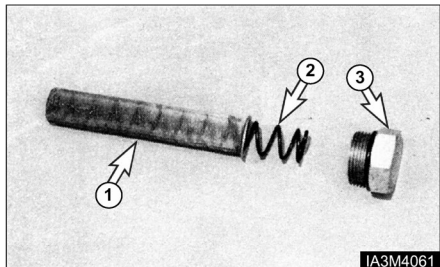

2. Wash the strainer (screen) ①, spring ② and drain plug ③ in clean, nonflammable solvent. Dry and install the strainer, spring and drain plug.
3. Raise the hood and seat assembly.

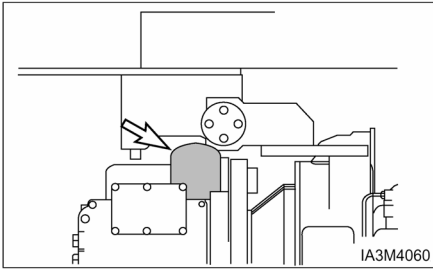

4. Remove and discard the oil filter. Wipe off the filter base. Make sure all of the old seal is removed.
5. Put a small amount of clean oil on the seal on the new filter. Install the filter by hand. When the filter contacts the base, tighten it an additional 3/4 turn.
6. Close the hood and seat assembly.



7. Open the access door in the floor plate.
8. Remove the dipstick/filter cap. Fill the transmission with oil. See "Refill Capacities" Install the dipstick/filter cap.



9. Start the engine.
10. With the service brake applied and engine at low idle, shift the transmission to forward and reverse to fill the clutches.
11. Shift the transmission into NEUTRAL. Apply the parking brake.
12. Remove the dipstick/ filter cap.
13. Maintain the oil level between the Min and Max marks on the dipstick/filter cap.

When the oil temperature is 40°C approximately, the cold side mark on the dipstick is applicable. When the oil temperature is 80°C approximately, the hot side mark on the dipstick is applicable.
14. Check for oil leaks at the filter and drain plug.
15. Stop the engine.

Drive Axle Oil - Check, Clean, Change

Park the lift truck on a level surface, parking brake applied, transmission in neutral.

WARNING

Hot oil and components can cause personal injury. Do not allow hot oil or components to contact skin.

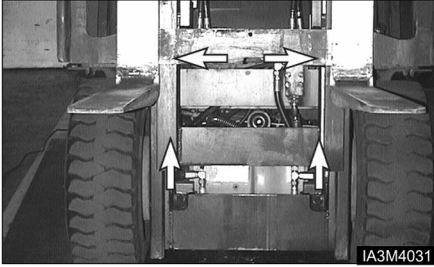

1. Lift the carriage high enough to access the drive axle housing fill plug with breather.
2. Block the bottom of the mast with a block of wood to hold the carriage in the raised position.
3. Turn the ignition switch OFF.

Shoe Brake Type

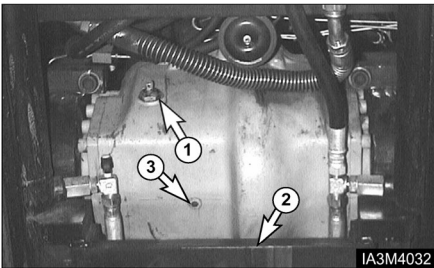

1. Remove the fill plug with breather. Wash it in clean, nonflammable solvent.
2. Place an appropriate container under the axle to catch the oil as it drains. Remove the drain plug.

3. Allow the oil to drain completely out. Discard the oil according to local regulations.
4. Clean and reinstall the drain plug.
5. Remove the oil level plug.
6. Add sufficient fresh oil through the fill opening until it reaches the bottom of the oil level plug opening ③.
See the section, "Lubricant Specification – Drive Axle Oil" and "Refill Capacity".
7. Clean and reinstall the oil level plug and fill plug with breather.
8. Remove the blocks from under the carriage. Lower the carriage.
9. Operate the lift truck for a few minutes. Check oil level again. See topic, "Drive Axle Oil - Check" in "Every 250 Service Hours or Monthly".

Oil Cooled Disc Brake (OCDB) Type

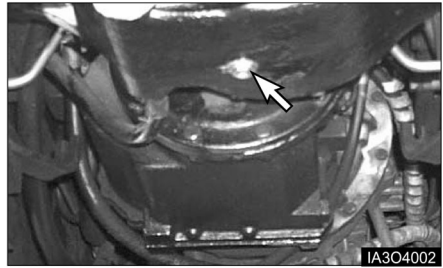

1. Remove drain plug. Allow the oil to drain into a suitable container. Clean the magnetic drain plug. Check O-ring seal and replace if necessary.
2. Install the drain plug.

Parking Brake - Test, Adjust

NOTE: Be sure area around the lift truck is clear of personnel and obstructions.

1. Drive the lift truck with a capacity load, forward up a 15% incline [a slope that increases 1.5 meters in 10 meters (1.5 ft increase in 10 ft)].

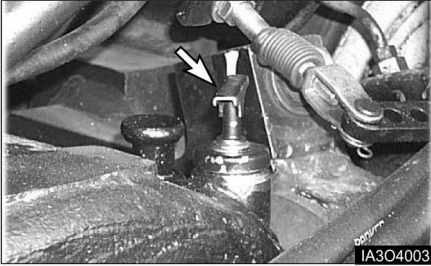

3. Remove the dip stick/filter cap. Fill the drive axle housing with oil. See "Lubricant Specification - Drive Axle Oil" and "Refill Capacity"
4. Start the lift truck. With the engine at low idle, place the directional control lever to the NEUTRAL.
5. Maintain the oil level between lower mark and upper mark on the dip stick/filter cap.
6. Install the dip stick/filter cap.

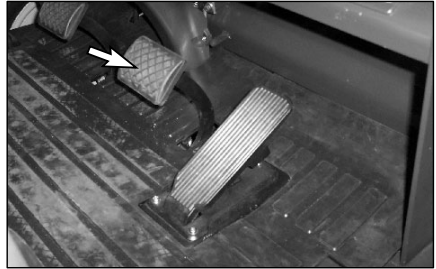

2. Halfway up the incline, stop the lift truck with the service brake.

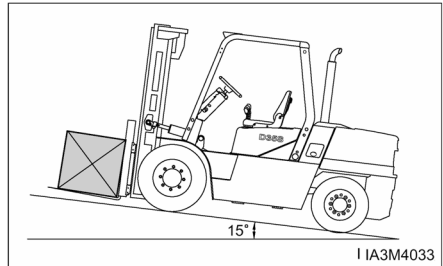

3. Apply the parking brake and slowly release the service brake.
4. The parking brake should hold the lift truck. If the lift truck starts to move, immediately apply the service brakes. Have the parking brake adjusted.

To Adjust

Park the lift truck level, with the forks lowered, transmission in NEUTRAL, the engine stopped and the wheels securely blocked.

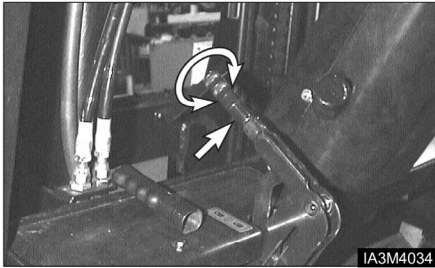

1. Release the parking brake.
2. Turn the adjustment knob, clockwise to tighten the brake.
3. Test the parking brake adjustment. Repeat the adjustment procedure, if necessary.

First 250 Service Hours or a Month

You must read and understand the warnings and instructions contained in the Safety section of this manual, before performing any operation or maintenance procedures.

Hydraulic Return Filter - Change

WARNING

Hot oil and components can cause personal injury. Do not allow hot oil or components to contact skin.

Park the lift truck level with the forks lowered, parking brake engaged, transmission in NEUTRAL and the engine stopped.

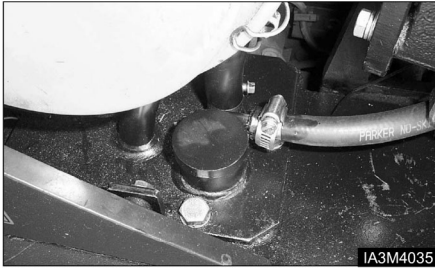

1. Raise the hood and seat assembly. Loosen the bolts of the hydraulic tank cover, and remove the hydraulic tank cover with filter assembly.

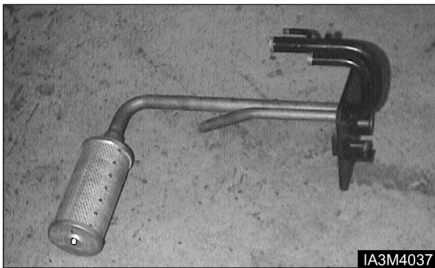

2. Remove filter assembly from the hydraulic tank cover.

3. Install new filter assembly in the hydraulic tank cover.
4. Inspect cover gasket for damage, replace it if necessary.
5. Clean and Install the cover and tighten retaining bolts.
6. Lower the hood and seat assembly.

Every 250 Service Hours or Monthly

You must read and understand the warnings and instructions contained in the Safety section of this manual, before performing any operation or maintenance procedures.

Air Intake System - Check, Clean Precleaner (If Equipped)

NOTICE

Never service precleaner with the engine running.

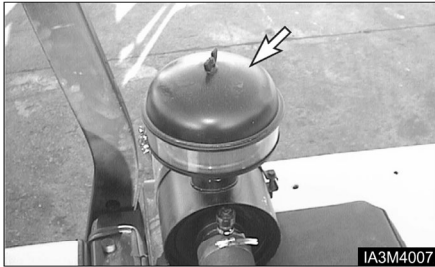

Typical Example

Diesel Engine Truck

Servicing Filter Element

NOTICE

Never service precleaner with the engine running.

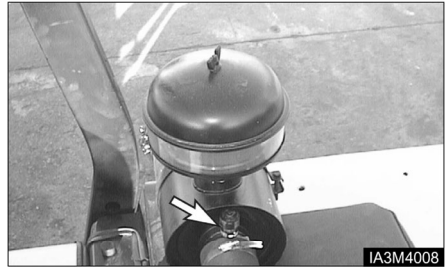

Typical Example

Diesel Engine Truck

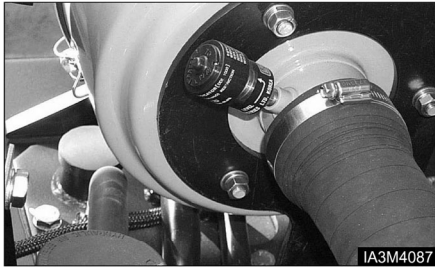

Typical Example

LP-Gas Engine Truck

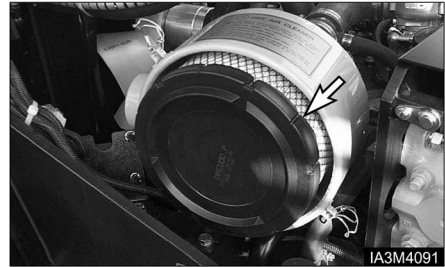

Typical Example

LP-Gas Engine Truck

1. Check the precleaner bowl for dirt build-up. If the dirt is up to the line, remove the precleaner bowl and empty it. Periodically wash the cover and bowl in water.

Service the air cleaner when the red target in the service indicator stays locked in the visible position with the engine stopped.

1. To service the air cleaner, loosen the cover latches and remove the cover.

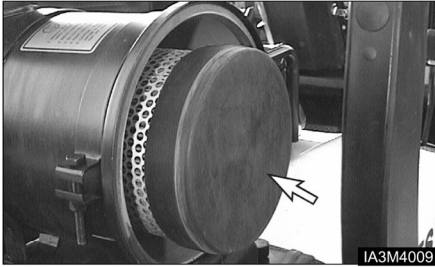

Typical Example

Diesel Engine Truck

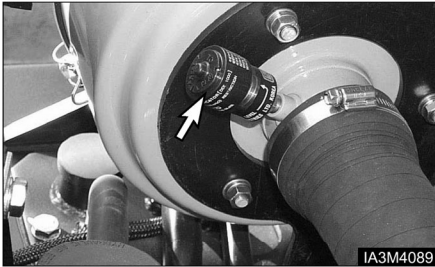

Typical Example

LP-Gas Engine Truck

6. Reset the air cleaner service indicator.
7. Install the air filter element.
8. Install the cover and tighten the cover latches.
9. Start the engine and observe the position of the indicator. If the indicator shows RED after the installation of the primary element, install another clean or a new element or, replace the secondary element. See topic, "Air Intake System - Change" in Every 1000 Service Hours or 6 months section.
10. Stop the engine and close the hood and seat assembly.

2. Rotate the element slightly to separate it from its base and remove it from the air cleaner housing.
3. Clean and inspect the element or replace with a new element. See topic, "Cleaning Primary Filter Element".
4. Clean the inside of air cleaner housing and the cover. Inspect all connections between the air cleaner and engine. Check intake hose for cracks, damage and loose clamps. Tighten or replace parts as necessary to prevent leakage.

NOTICE

Do not allow dirty air to enter the intake hose when cleaning the inside of the air cleaner housing.

5. Check the air cleaner housing for loose latches.

Cleaning Primary Filter Elements

⚠ WARNING

Pressure air can cause personal injury.

When using pressure air for cleaning, wear a protective face shield, protective clothing and protective shoes.

The maximum air pressure must be below 205 kPa (30 psi) for cleaning purposes.

NOTICE

Do not clean the elements by bumping or tapping them.

Inspect filter elements after cleaning. Do not use a filter with damaged pleats, gaskets or seals.

When cleaning with pressure air, use 205 kPa (30 psi) maximum pressure to prevent filter element damage.

When cleaning with pressure water, use 280 kPa (40 psi) maximum pressure to prevent filter element damage.

Have spare elements on hand to use while cleaning used elements.

The primary element should be replaced after a year's service or after cleaning no more than 6 times.

Air-205 kPa (30 psi) Maximum Pressure

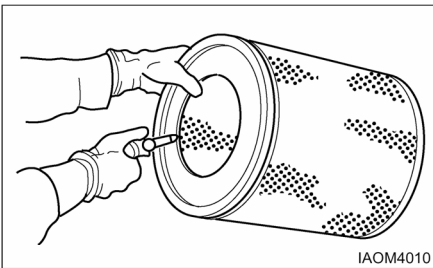

Direct air on the inside and outside of the element along the length of the pleats. Check the element for any tears, rips or damage.

Water-280 kPa (40 psi) Maximum Pressure

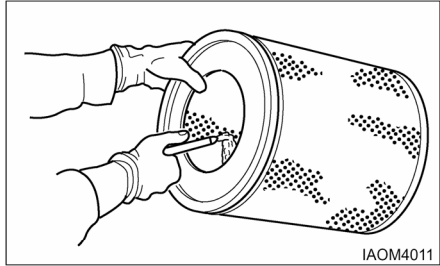

Direct water on the inside and outside of the element along the length of the pleats. Air dry it thoroughly and then examine it.

Detergent

1. Wash the element in warm water and mild household detergent.
2. Rinse the element with clean water. See instructions in preceding topic for cleaning with water.
3. Air dry it thoroughly, and then examine it.

Checking Element

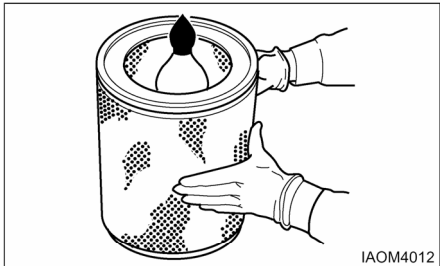

1. Insert a light inside the clean dry element and examine it. Discard the element if tears, rips or damage are found.
2. Wrap and store good elements in a clean, dry place.

Hydraulic Oil Level - Check

WARNING

At operating temperature, the hydraulic tank is hot and under pressure.

Hot oil can cause burns.

Remove the filter cap only when the engine is stopped, and the cap is cool enough to touch with your bare hand. Remove the filter cap slowly to relieve pressure.

1. Operate the lift truck for a few minutes to warm the oil. Park the lift truck on a level surface, with the forks lowered, mast tilted back, parking brake engaged, transmission in NEUTRAL and the engine stopped.
2. Raise the hood and seat assembly. Make sure the air lift cylinder securely holds the hood open.



3. Remove the dipstick/ filter cap. Maintain the oil level to the FULL mark on the breather/dip stick.

Drive Axle Oil Level - Check

WARNING

Hot oil and components can cause personal injury. Do not allow hot oil or components to contact skin.

Park the lift truck on a level surface. Apply the parking brake. The engine is at the low idle. Place the directional control level in NEUTRAL.

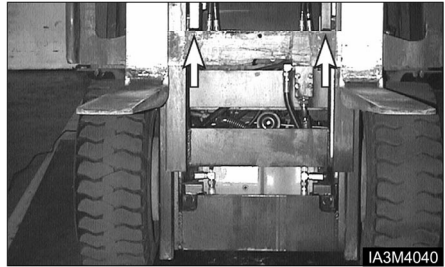

1. Lift the carriage high enough to access the drive axle housing oil level plug and fill plug.
2. Put blocks under the carriage.

Shoe Brake Type

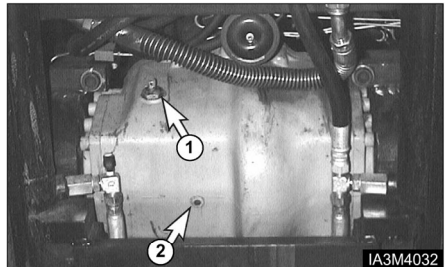

1. Remove the housing oil level plug ① and fill plug ②. Maintain the lubricant level to the bottom of the plug opening.
2. Clean and install the oil level plug ① and fill plug ②.

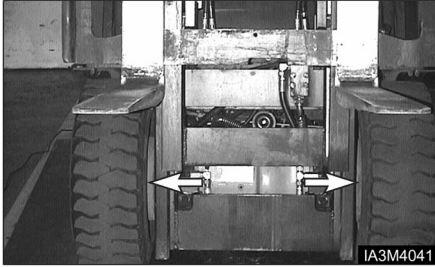

3. Remove the blocks from under the carriage. Lower the carriage.

Oil Cooled Disc Brake (OCDB) Type

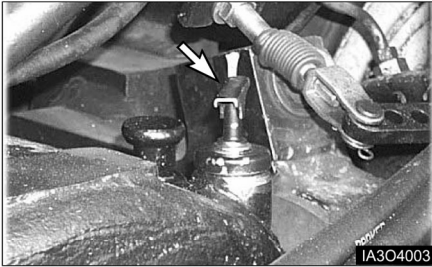

1. Remove the dip stick/filter cap. Observe the oil level.
2. Maintain the oil level between lower mark and upper mark on the dip stick/filter cap.
3. Install the dip stick/filter cap.

Mast, Carriage, Lift Chains, & Attachments - Check, Lubricate

1. Operate the lift, tilt and attachment controls. Listen for unusual noises. These may indicate a need for repair.
2. Inspect for loose bolts and nuts on the carriage. Remove any debris from the carriage and mast.
3. Inspect the forks and attachments for free operation and damage. Have repairs made if necessary.

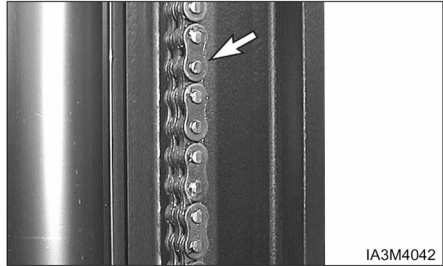

4. Brush a film of oil on all links of the chain.
5. Raise and lower the carriage a few times to work lubricant into the chain links.

NOTICE

Lubricate chains more frequently than normal in applications where the lift truck is operating in a atmosphere which could cause corrosion of components or when lift truck must work in rapid lift cycles.

6. Inspect the chain anchors and individual links for wear, loose pins or cracked leaves.

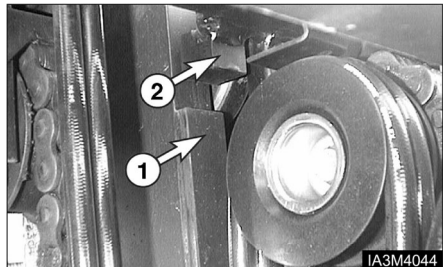

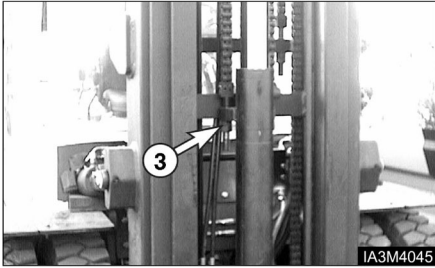

7. In case of Full Free Lift Mast, Extend the primary cylinder to full length and then check the clearance and over lapped dimension between carriage stopper bolt or block (1) and Inner mast stopper block (2). Adjust the chain anchor bolt (3) so that clearance should be 14 ± 2 mm.

And adjust the overlapped dimension to be 10 ± 2 mm by moving or inserting washer.

Carriage Side Rollers - Lubricate



D35/40S-2, D40/45SC-2, G35/40S-2, G45/50SC-2

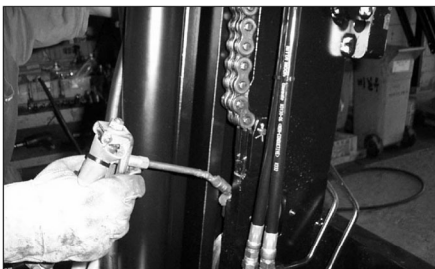

D45S-2, D50SC-2, D50C-2, G45S-2, G50SC-2

Lubricate 2 side roller fittings, one on each side of the carriage

Steering Mechanism - Check, Lubricate

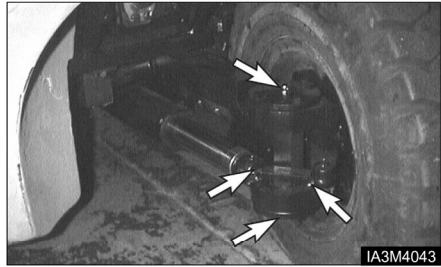

1. Lubricate the steer axle king pins, total of four fittings. Two on the right side and two on the left side.
2. Lubricate the steering link bearings, total of four fittings. Two on the right side and two on the left side.
3. Check for any worn or loose components of the steering mechanism. Remove any debris or trash as required.

Battery Terminal - Clean, Inspect

⚠ WARNING

Batteries give off flammable fumes that can explode.

Do not smoke when observing the battery electrolyte levels.

Electrolyte is an acid and can cause personal injury if it contacts skin or eyes.

Always wear protective glasses when working with batteries.

TIER I Diesel Engine(DB58) Only



Typical Example

Diesel Engine Truck

LP-Gas Engine - 12V X 1



Typical Example

LP-Gas Engine Truck

1. Clean the top of the battery and terminals.
2. Check terminals for corrosion. Coat terminals with heavy grease.

Engine Oil & Filter – Change

TIER I Diesel Engine(DB58)

See topic, “Engine Oil & Filter (Diesel Engine Only) - Change” in “First 50-100 Service Hours”.

LP-Gas Engine Crankcase

1. Operate lift truck a few minutes to warm oil. Park the lift truck with the forks lowered, parking brake applied, transmission in neutral and the engine stopped.
2. Raise rear of lift truck off ground and block securely.

⚠ WARNING

Hot oil and components can cause personal injury. Do not allow hot oil or components to contact skin.

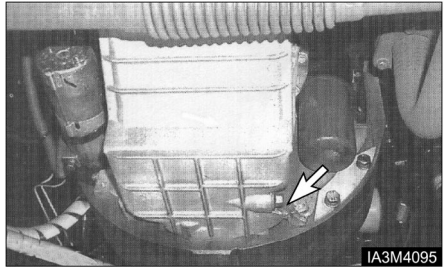

3. Remove the crankcase drain plug and allow oil to drain. Clean and install drain plug.
4. Raise the hood and seat assembly.
5. Remove and discard oil filter element.
6. Wipe sealing surface of oil filter element mounting base. Make sure the entire old gasket is removed.
7. Before installing a new filter element, apply a small amount of clean engine oil to the filter element gasket.

8. Install the new filter element. When the gasket contacts the base, tighten it 3/4 of a turn more. Do not overtighten.
9. Raise the lift truck, remove the blocking and lower the lift truck.
10. Fill the crankcase. See "Refill Capacities".
11. Start the engine and allow the oil to fill the filter and passages.
12. Check for oil leaks.

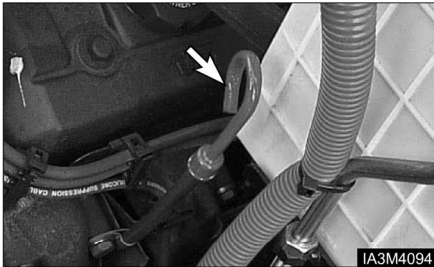

IA3M4094

13. Stop the engine and measure the oil level. Maintain the oil level to the FULL mark on the dip stick.
14. Close hood and seat assembly.

Wheel Bolts and Nuts - Inspect

Inspect Tightness

NOTICE

Do not lubricate ball seas of wheels or ball faces of wheel nuts.

Be sure mounting faces of hub, wheel nuts and flat mounting surfaces are clean.

Tighten wheel nuts again after 24 hours of operation.

NOTE: Always tighten wheel lug nuts in a sequence opposite (180°) each other.

If equipped with dual wheels, follow the same nut tightening sequence for both wheels.

Steer Wheels

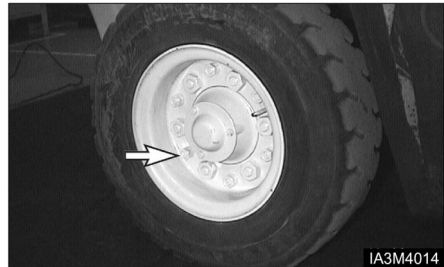

IA3M4014

Install steer wheel. Put two nuts opposite (180°) each other. Tighten both. Install remaining nuts. Tighten all nuts in a sequence opposite (180°) each other. Tighten to 440 ± 35 N•m (325 ± 25 lb•ft).

Drive Wheels



IAOM4015

Install drive wheel. Put two nuts opposite (180°) each other. Tighten both.

Install the remaining nuts. Tighten all nuts in a sequence opposite (180°) each other. Tighten to 600 ± 90 N•m (440 ± 60 lb•ft).

Every 500 Service Hours or 3 Months

You must read and understand the warnings and instructions contained in the Safety section of this manual, before performing any operation or maintenance procedures.

Belts (Diesel Engine Only) - Check, Adjust

1. Raise the hood and seat assembly.

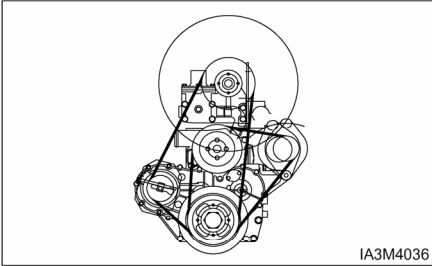

2. Check the condition and adjustment of the belts. Correct adjustment allows 10 mm (3/8 inch) deflection under 110N of force.

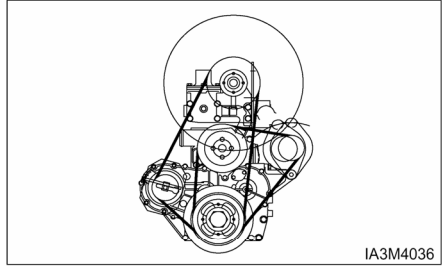
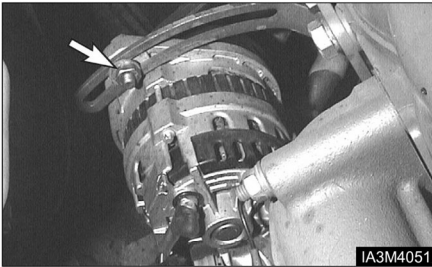

4. To adjust fan belt, loosen idler pulley mounting bolt. Move idler pulley in or out as required. Tighten idler pulley mounting bolt.
5. Lower the hood and seat assembly.

Mast Hinge Pins – Lubricate

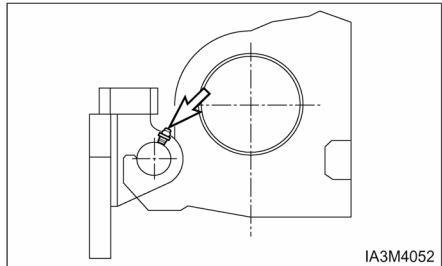

Typical Example

1. Lower the forks and tilt the mast forward.
2. Lubricate the two fittings for the mast hinge pins, one on each side of the mast.

NOTICE

Failure to loosen the alternator mounting bolt will cause excessive stress and break the alternator mounting gear.

3. To adjust the alternator drive belt, loosen adjusting bracket bolt. Move the alternator in or out as required. Tighten bolts.

Tilt Cylinders - Check, Adjust, Lubricate

Chassis Pivot Eyebolts

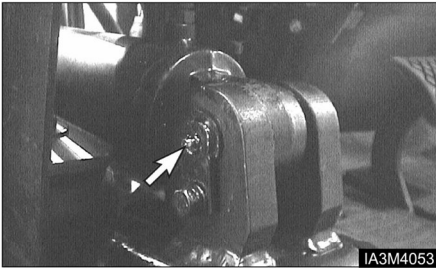

Typical Example

1. Lubricate two fittings for the pivot eyebolts, one on each tilt cylinder.
2. Check the pivot eye pins for loose retainer bolts and wear.

Mast Pivot Eyes

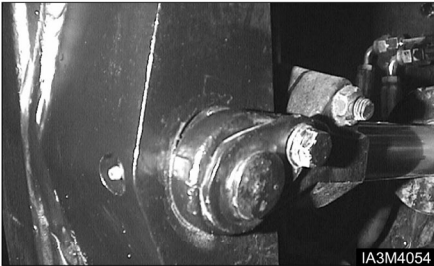

Typical Example

1. Lubricate two fittings for the mast pivot eyes, one on each side of the mast.
2. Check the pivot eye pins for loose retainer bolts and wear.

Cylinder Rod Extension

NOTE: The following description is for forward tilt. For cylinder rod back tilt, the collar should be stationary by the tilt eye. If it is not, the O-ring inside the collar may need to be replaced. To adjust back tilt, spacers must be added or removed.

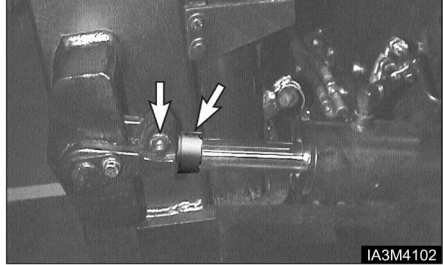

Typical Example

1. Check to make sure the tilt cylinders extend and retract evenly.
2. If one cylinder continues to move after the other cylinder has stopped in full forward or backward tilt, an adjustment must be made to one cylinder.

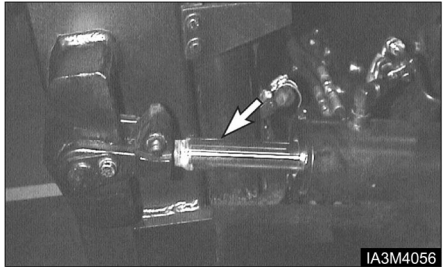

Typical Example

3. To adjust the cylinder rod extension, move the spacer to the rear and loosen the pinch bolt on the clevis.
4. Turn the cylinder rod in or out of the clevis to obtain the proper adjustment. Turning the rod into the clevis shortens the stroke. Turning the rod out of the clevis lengthens the stroke. When turning for extending rod, the overlapped length between clevis's thread and cylinder rod must be minimum 32 mm.
5. Tighten the pinch bolts to a torque of $95 \pm 15 \text{ N}\cdot\text{m}$ ($70 \pm 10 \text{ lb}\cdot\text{ft}$). Check the cylinder rods again for even travel.

Crosshead Rollers - Inspect

1. Operate the mast through a lift cycle. Watch the chains move over the crosshead rollers. Make sure the chain is tracking over the rollers properly.

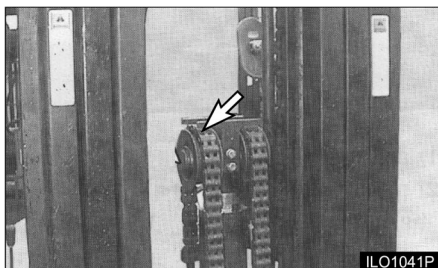

Typical Example

2. Check for damaged crosshead rollers, guards and retainer rings.

Carriage Side Rollers Thrust (If Equipped) - Lubricate

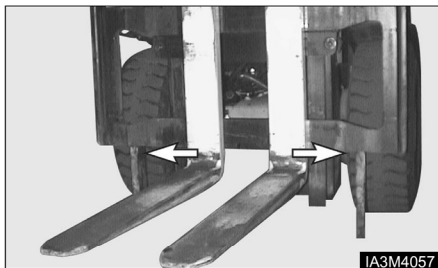

1. Raise the carriage high enough to gain access to the side thrust rollers on the back side of the carriage. Block the carriage in this position.

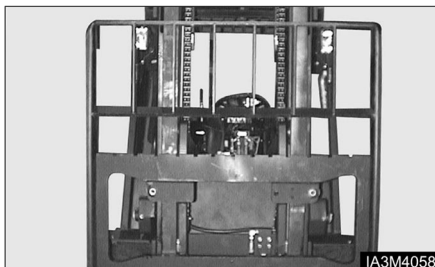

2. Lubricate 2 side thrust roller fittings, one on each side of the mast.
3. Raise the carriage, remove the blocking. Lower the carriage to the floor.

Carriage Sideshifter (If Equipped) – Lubricate

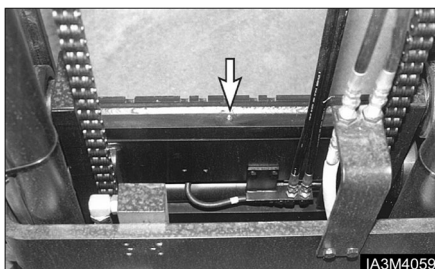

1. Lubricate 4 (6) fittings. The forks may have to be moved to gain access to all of the fittings.
2. Operate the sideshifter carriage through several complete cycles to distribute the grease the carriage to the floor.

Parking Brake - Test, Adjust

See topic, "Parking Brake - Test, Adjust" in "First 50-100 Service Hours."

Circulation Pump Belt (OCDB & LP-Gas Engine Only) - Check, Adjust

1. Raise the hood and seat assembly.

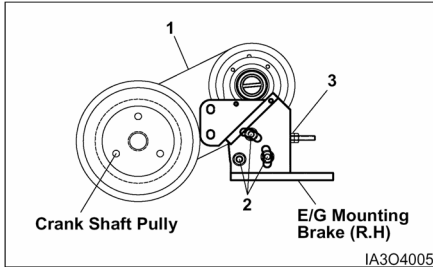

2. Check the condition and adjustment of the belt (1). Correct adjustment allows 10 mm (3/8 inch) deflection under 45 N of force.
3. To adjust the circulation pump belt, loosen the mounting bolts (2) and adjust the adjusting inner nut (3). Tighten the adjusting outer nut (4).
4. Lower the hood and seat assembly.

Drive Axle Oil & Strainer (OCDB Only) - Check, Clean, Change

WARNING

Hot oil and components can cause personal injury. Do not allow hot oil or components to contact skin.

Park the lift truck on a level surface. Apply the parking brake. Place the directional control lever in NEUTRAL and stop the engine.

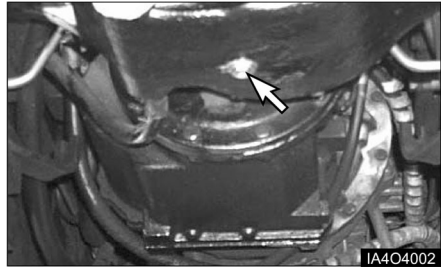

1. Remove drain plug. Allow the oil to drain into a suitable container. Clean the magnetic drain plug. Check O-ring seal and replace if necessary.
2. Install the drain plug.
3. Remove strainer assembly.

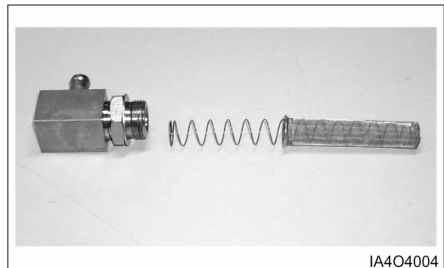

4. Washer the strainer assembly in clean, nonflammable solvent and dry it.
5. Install the strainer assembly and reconnect the hose and harness.



6. Remove the dip stick/filter cap. Fill the drive axle housing with oil. See "Lubricant Specification - Drive Axle Oil" and "Refill Capacity".
7. Start the lift truck. With the engine at low idle, place the directional control lever to the NEUTRAL.
8. Maintain the oil level between lower mark and upper mark on the dip stick/filter cap.
9. Install the dip stick/filter cap.

Engine Oil & Filter - Change

TIER II Diesel Engine (DB58S) Only

See topic, "Engine Oil & Filter(Diesel Engine Only) - Change" in "First 50-100 Service HOURS".

Inching & Brake Control shaft - Lubricate

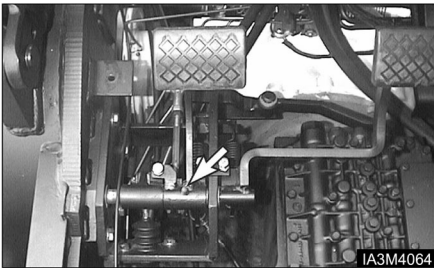

Lubricate two fittings for the inching and brake pedal control shaft.

Horn & Lights (If Equipped) – Check

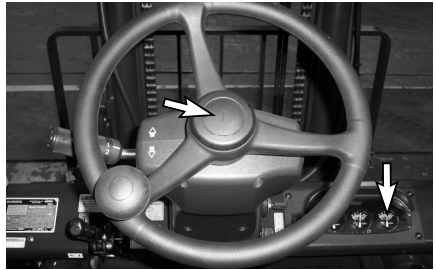

1. Press horn button, to determine if horn is operational.
2. Check and replace all defective gauges.
3. Check all lights such as warning, directional, backup, driving and flood lights for correct operation. Replace all burned out bulbs. Have repairs made if needed.

Inspect Vacuum Lines and Fittings (G643E Engine only)

1. Visually inspect vacuum lines and fittings for physical damage such as brittleness, cracks and kinks. Repair/replace as required.
2. Solvent or oil damage may cause vacuum lines to become soft resulting in a collapsed line while the engine is running.
3. If abnormally soft lines are detected, replace as necessary.

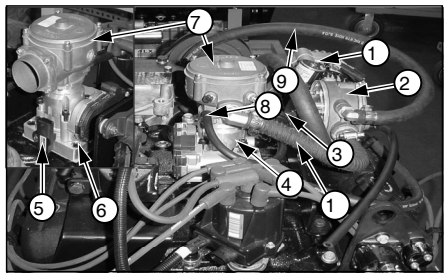

- (1) LP fuel lock-off, (2) LP regulator/converter
- (3) Fuel Trim Valve (FTV), (4) Adapter-Throttle body
- (5) TMAP sensor, (6) Adapter-Manifold, (7) LP mixer
- (8) Vacuum lines, (9) Coolant lines, (10) LP fuel line

Fuel Trim Valve(FTV) Inspection (G643E Engine only)

1. Visually inspect the Fuel trim valve(3) for abrasions or cracking. Replace as necessary.
2. To ensure the valve is not leaking a blow-by test can be performed.
3. With the engine off, disconnect the electrical connector to the FTV.
4. Disconnect the vacuum line from the FTV to the pressure regulator/converter, at the converter's tee connection.
5. Lightly blow through the vacuum line connected to the FTV. Air should not pass through the FTV when de-energized. If air leaks past the FTV when de-energized, replace the FTV.

Inspect Electrical System (G643E Engine only)

1. Check for loose, dirty or damaged connectors and wires on the harness including: Fuel lock-off, TMAP sensor, O2 sensor, Electronic throttle, Control Relays, Fuel Trim Valve, Foot Pedal, and Distributor sensor.
2. Repair and/or replace as necessary.

Overhead Guard – Inspect

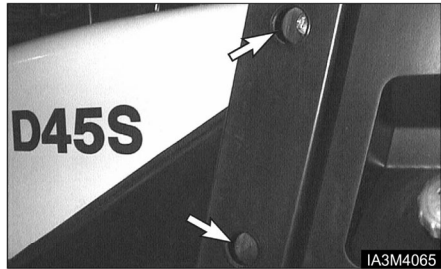

1. Check tightness of overhead guard mounting bolts at 80 N•m (60 lb•ft).
2. Check overhead guard for bent or cracked sections. Have repairs made if needed.

Steer Suspension - Inspect



1. Inspect the suspension mounting bolts. Tighten suspension mounting bolts, if necessary, to 240±30 N•m (180±20 lb•ft).



2. Look for leaks at the power steering hose connections.
3. Remove any trash buildup on the suspension or the steer axle.

Every 1000 Service Hours or 6 Months

You must read and understand the warnings and instructions contained in the Safety section of this manual, before performing any operation or maintenance procedures.

Carburetor (LP - Gas Engine Only) - Adjust, Clean

If the engine is hard to start or the exhaust is smoking, the carburetor may need cleaning and adjusting.

Before adjusting the carburetor make sure the engine is at normal operating temperature. Park the lift truck with the forks lowered, parking brake applied, transmission in neutral and the engine stopped.

For the complete procedure and specifications for your specific engine, see the "Service Manual".

Fuel Filters - Change Diesel Engine

Park the lift truck with the forks lowered, parking brake applied, transmission in neutral, engine stopped and cool.

1. Raise the hood and seat assembly. Make sure the hood support latch is engaged in the bracket.

WARNING

Fuel leaked or spilled onto hot surfaces or electrical components can cause a fire.

Turn the disconnect switch OFF or disconnect the battery when changing fuel filters.

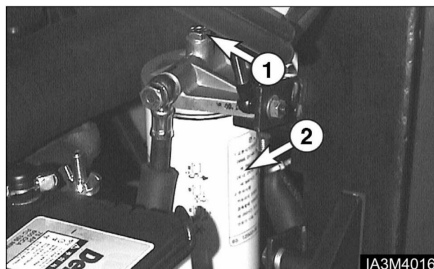

2. Loosen the plug (1) and remove cartridge (12) from head.
3. Fill up clean fuel to the new cartridge.
4. Replace the rubber packing and smear clean fuel to the rubber packing.
5. Install new cartridge and remove an air in the filter with a feed pump.

Air Intake System - Change

Changing Primary Element

See topic, "Air Intake System - Check, Clean" in "Every 250 Service Hours or Monthly".

Changing Secondary Element

Replace the secondary element after the primary element has been cleaned three times or yearly.

1. Remove the primary air cleaner element. See topic "Servicing Filter Element". Clean the inside of the air cleaner housing and cover.



2. Remove the secondary element. Inspect the gasket between the air cleaner housing and the engine inlet. Replace the gasket if it is damaged.

NOTICE

Always replace the secondary element. Do not attempt to reuse it by cleaning.

3. Install a new secondary element. Install a new or cleaned primary element. Install the cover. Tighten the latches.
4. Start the engine and observe the air cleaner service indicator. If the indicator shows RED after installing a new secondary element and a cleaned primary (outer) element, replace the cleaned primary filter with a new element.
5. Stop the engine. Close the hood and seat assembly.

Inspect Coolant Hoses (LP Engines Only)

1. Visually inspect coolant hoses and clamps. Remember to check the two coolant lines that connect to the pressure regulator/converter.
2. Replace any hose that shows signs of swelling, cracking, abrasion or deterioration.

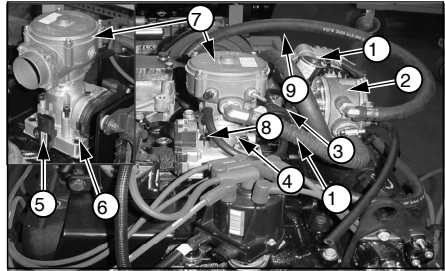

- (1) LP fuel lock-off, (2) LP regulator/converter
 (3) Fuel Trim Valve (FTV), (4) Adapter-Throttle body
 (5) TMAP sensor, (6) Adapter-Manifold, (7) LP mixer
 (8) Vacuum lines, (9) Coolant lines, (10) LP fuel line

LP Regulator/Converter Inspection (LP Engine Only)

1. Visually inspect the pressure regulator/converter housing(2) for coolant leaks. Refer to the pressure regulator/converter section of the service manual if maintenance is required.

NOTE: For pressure testing and internal inspection of the pressure regulator/converter, refer to the pressure regulator/converter section of the service manual.

Fuel Lines & Fittings - Check

Visually inspect fuel lines and fittings for physical damage. Replace as required.

Inspect Mixer Assembly (G643E Engine Only)

Refer to the LP mixer section of the engine service manual for procedures.

Inspect Throttle Assembly (G643E Engine Only)

1. Visually inspect the throttle assembly motor housing for coking, cracks and missing cover-retaining clips. Repair and/or replace as necessary.

NOTE: Refer to the LP mixer and throttle section of the service manual for procedures on removing the mixer and inspecting the throttle plate.

Hydraulic Return Filter - Change

See topic "Hydraulic Return Filter - Change" in "First 250 Service Hours or a Month".

Air Breather - Change

Park the lift trucks level, with the forks lowered, parking brake engaged, transmission in NEUTRAL and the engine stopped.

1. Raise the hood and seat assembly.
2. Remove and discard the air breather.



3. Install a new air breather.
4. Lower the hood and seat assembly.

Transmission Oil, Oil Filter & Strainer - Clean, Change

See topic, "Transmission Oil, Oil Filter & Strainer - Clean, Change" in "First 50 - 100 Service Hours or a Week".

Lift Chains - Test, Check, Adjust

Lift Chain Wear Test

Inspect the part of the chain that is normally operated over the cross head roller. When the chain bends over the roller, the movement of the parts against each other causes wears.

Inspect to be sure that chain link pins do not extend outside of the link hole. If any single link pin is extended beyond its connecting corresponding link, it should be suspected of being broken inside of its link hole. Lift chains are required to check for wear about every 1,000 service hours or 6 months.

Chain wear test is a measurement of wear of the chain links and pins. Take the following steps to check chain wear.

1. Lift the mast and carriage enough for getting tension on lift chains.



Typical example

2. Measure precisely ten links of chain distance at the center of pins in millimeter.
3. Calculate chain wear rate*.
4. If the chain wear rate is 2% or more, replace the lift chain.

*Chain wear rate (%)

$$= \left(\frac{\text{Actual measurement} - \text{Pitch}^{**} \times 10}{\text{Pitch}^{**} \times 10} \right) \times 100$$

**Chain Pitch for D35/40/45S-2, D40/45/50SC-2, D50C-2, G35/40/45S-2, G40/45/50SC-2 = 25.40 mm(1.0 in)

Check for Equal Tension



Typical example

Lift the carriage and the mast high enough for getting tension on lift chains. Check the chains, and make sure the tension is the same. Lift chains are required to check for equal tension about every 1,000 service hours or 6 months.

WARNING

Personal injury can be caused by sudden movement of the mast and carriage.

Keep hands and feet clear of any parts that can move.

Lift Chain Adjustment



Typical example for carriage equal tension

If the tension is not the same on both chains, take the procedure as follows.

NOTE: If carriage height is not correct, make adjustments by following procedures.

Carriage Chain Adjustment

Make sure that carriage height is correct. If correct, adjust the chain for equal tension. If not, adjust the chain for correct carriage height by adjusting anchor nuts(1),(2).

NOTE: See the previous section, "Carriage Roller Extrusion" in "When Required" for proper height of carriage.

1. Fully lower the carriage and tilt mast forward or lift the carriage and put blocks under the carriage to release the tension from the lift chains.
2. Loosen nut(1) and adjust nut(2) to get proper distance from bottom of inner upright to the bottom of carriage bearing.

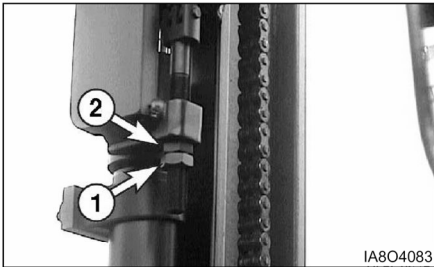

Typical example for carriage chain of STD mast

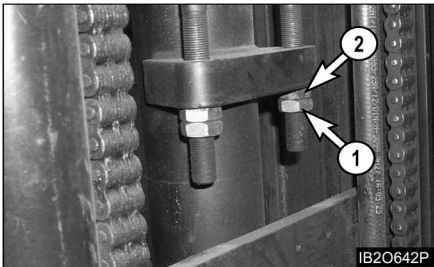

Typical example for carriage chain of FF,FFT mast

3. Make adjustment anchor nut(1),(2) for equal chain tension.
4. Set the mast vertical and raise the carriage and check equal chain tension. If not equal, repeat the same procedure as step 1 through step 3.
5. Put LOCTITE No. 242 Tread lock on the threads of the anchor nuts(1),(2) after the adjustment is completed.

Mast Chain Adjustment - FF,FFT Mast

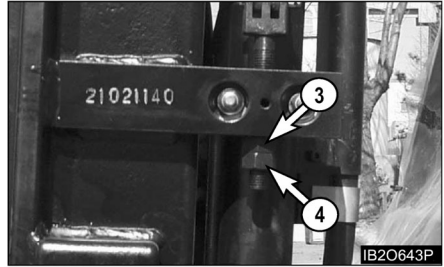

Typical example for FF mast

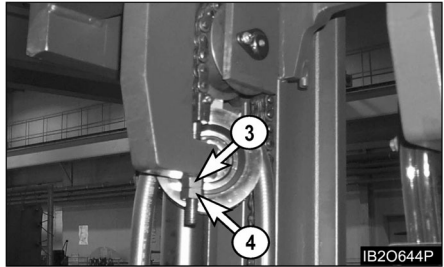

Typical example for FFT mast

Make sure that mast height is correct. If correct, adjust chain for equal tension. If not, adjust mast chain for correct mast height by adjusting anchor nuts (3), (4).

NOTE: See the previous section, "Carriage Roller Extrusion" in "When Required" for proper inner mast height.

1. Lift the inner mast and put blocks under the inner mast to release the tension from the lift chains.
2. Loosen nut(3) and adjust nut(4) to make inner mast rail flush with outer mast rail bottom.
3. Make adjustment anchor nuts(3),(4) for equal chain tension.
4. Raise the inner mast and check equal chain tension. If not equal, repeat the same procedure as step 1 through step 3.
5. Put LOCTITE No. 242 tread lock on the threads of the anchor nuts(3),(4) after the adjustment is completed.

Universal Joint (Diesel Engine Only) - Inspect

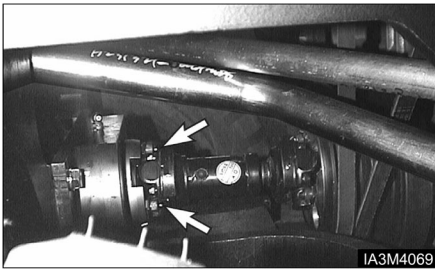

1. Inspect for loose retaining bolts. Check for worn or damaged bearings.

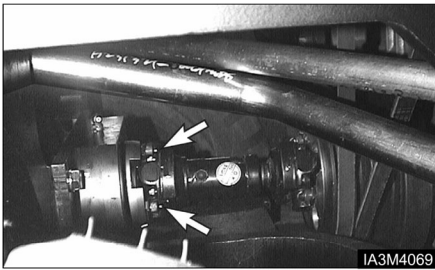

2. Have worn or damaged bearings replaced. Tighten the bolts if necessary.

Every 1500 Service Hours or 9 Months

You must read and understand the warnings and instructions contained in the Safety section of this manual, before performing any operation or maintenance procedures.

Drive Axle Oil (Shoe Brake Only) - Check, Clean, Change

See topic, "Drive Axle Oil - Check, Clean, Change" in "First 50-100 Service Hours or a Week".

Inspect Ignition System (LP-Gas Engine Only)

1. Disconnect Battery Cables.
2. Remove and inspect the spark plugs. Replace as required.
3. Test secondary cables with an Ohmmeter. If maximum resistance is higher than 25 kOhms, repair and/or replace.
4. Remove distributor cap and perform visual inspection. Replace cap and rotor if corrosion is found on the contacts.
5. Inspect the ignition coil for cracks and heat deterioration. Visually inspect the coil heat sink fins. If any fins are broken replace as required.



Replace Spark Plugs (LP-Gas Engine Only)

1. Disconnect Battery Cables.
2. Using a gentle twisting motion remove the high voltage cables from the spark plugs. Replace any damaged cables.
3. Remove the spark plugs.
4. Gap the new spark plugs to the proper specifications.
G643(E) Engine : 0.9 mm (0.035 inch)
5. Apply anti-seize compound to the spark plug threads and install.

G643(E) Engine : 30 N•m (22 lb•ft)

WARNING

Do not overtighten the spark plugs.

6. Re-install the high voltage cables.

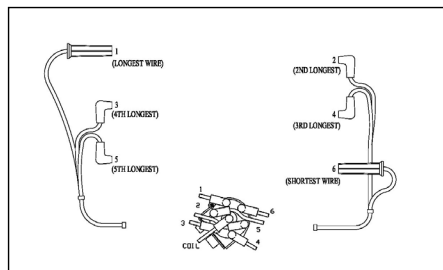
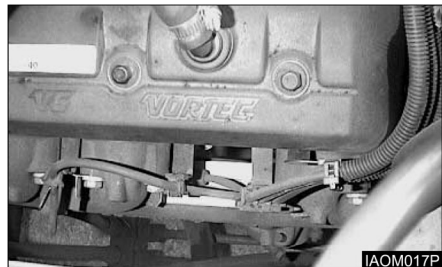

Replace LP Fuel Filter Element (LP-Gas Engine Only)

Park the lift truck in an authorized refueling area with the forks lowered, parking brake applied and the transmission in Neutral.

1. Close the fuel shutoff valve on the LP-Fuel tank. Run the engine until the fuel in the system runs out and the engine stops.
2. Turn off the ignition switch.
3. Scribe a line across the filter housing covers, which will be used for alignment purposes when re-installing the filter cover.

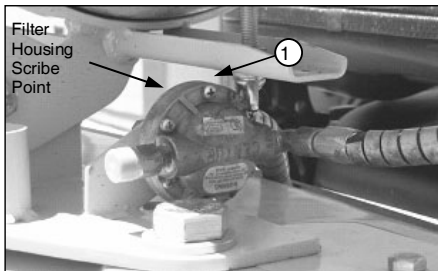

4. Remove the cover retaining screws (1)
- 2.

Fuel Filter (LP - Gas Engine Only)

Disassembly

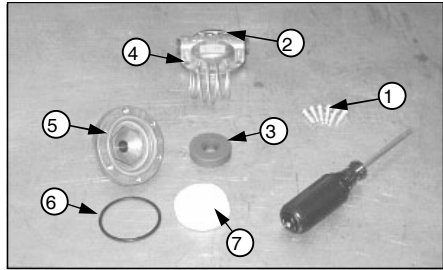

1. Remove top cover (2), magnet (3), spring (4), and filter element (7) from bottom cover (5).
2. Replace the filter element (7).
3. Check bottom cover O-ring seal (6) for damage. Replace if necessary.
4. Re-assemble the filter assembly aligning the scribe lines on the top and bottom covers.
5. Install the cover retaining screws, tightening the screws in an opposite sequence across the cover.
6. Open the fuel valve by slowly turning the valve counterclockwise.
7. Crank the engine several revolutions to open the fuel lock-off. **DO NOT START THE ENGINE.** Turn the ignition key switch to the off position.
8. Check the filter housing, fuel lines and fittings for leaks. Repair as necessary.

Testing Fuel Lock-off Operation (LP-Gas Engine Only)

1. Start engine.
2. Locate the electrical connector for the fuel lock
3. Disconnect the electrical connector.
4. The engine should run out of fuel and stop within a short period of time.
5. Turn the ignition key switch off and re-connect the fuel lock-off connector.

NOTE: The length of time the engine runs on trapped fuel vapor increases with any increase in distance between the fuel lock-off and the pressure regulator/converter.

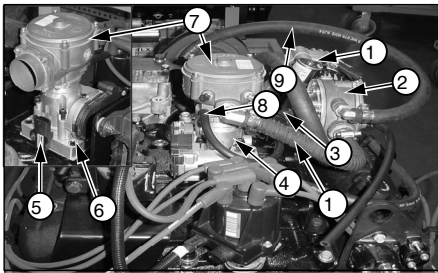

- (1) LP fuel lock-off, (2) LP regulator/converter
(3) Fuel Trim Valve (FTV), (4) Adapter-Throttle body
(5) TMAP sensor, (6) Adapter-Manifold, (7) LP mixer
(8) Vacuum lines, (9) Coolant lines, (10) LP fuel line

Every 2000 Service Hours or Yearly

You must read and understand the warnings and instructions contained in the Safety section of this manual, before performing any operation or maintenance procedures.

Steer Wheel Bearings - Reassemble

Park the lift truck level with the forks lowered, parking brake engaged, transmission in NEUTRAL and the engine stopped.



Typical Example

1. Lift the steer wheels off the ground. Place stands or blocking under the frame and steer axle to support the lift truck.
2. Remove the hub cap.

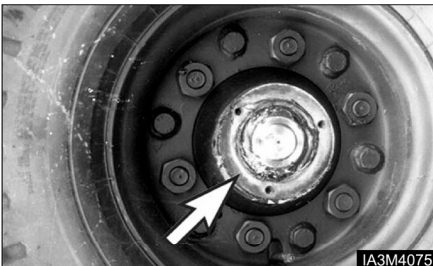

Typical Example

3. Remove the cutter pin.

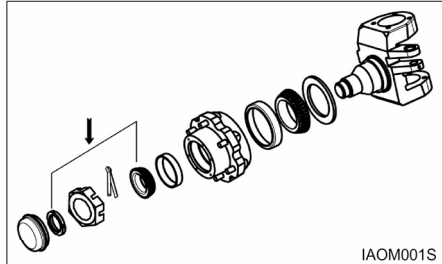

4. Remove the castle nut and washer.
5. Remove the wheel assembly. Examine the seal for damage and wear. Replace the seal if necessary.

⚠ WARNING

Deflate tire before removing wheel nuts at tire change.

6. Remove the inner bearing. Clean and lubricate the steering knuckle. Reassemble both the inner and outer bearing cones.
7. Install the inner bearing. Lubricate the seal and install the wheel assembly on the knuckle.
8. Install the outer wheel bearing and the outer washer. Install a new lock washer and fit the locknut.

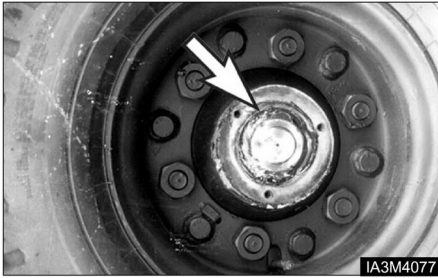

Typical Example

9. Tighten the locknut to $135 \text{ N}\cdot\text{m}$ ($100 \text{ lb}\cdot\text{ft}$), while turning wheel hub to seat the bearing.
10. Loosen the locknut. Retorque it to $50 \pm 5 \text{ N}\cdot\text{m}$ ($37 \pm 4 \text{ lb}\cdot\text{ft}$). Bend the lockwasher tang to secure locknut.
11. Install the hub cap.
12. Raise the lift truck and remove the blocking Lower the lift truck to the ground.

Cooling System - Clean, Change

WARNING

At operating temperature, the engine coolant is hot and under pressure.

Steam can cause personal injury.

Check the coolant level only after the engine has been stopped and the filter cap is cool enough to touch with your bare hand.

Remove the filter cap slowly to relieve pressure.

Cooling system conditioner contains alkali. Avoid contact with the skin and eyes to prevent personal injury.

Use all cleaning solutions with care.

The lift truck must be level, the forks lowered, the parking brake engaged, the transmission in NEUTRAL and the engine stopped and cool.



1. Turn the radiator cap slowly to relieve the pressure, then remove the cap.
2. Remove the block drain plug.

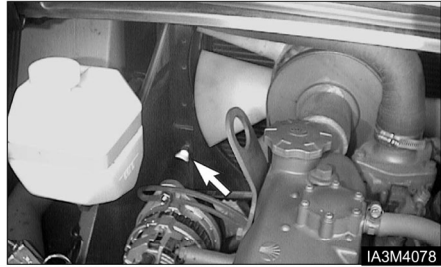

Typical Example

3. Open radiator drain valve. Allow the coolant to drain. Drain the recovery bottle.
4. Close radiator drain valve and install block drain plug. Fill the cooling system with 1 kg (2 lb) sodium bisulphate per 40 liters (10 gallons) of water. Most commercial cooling system cleaners can be used.
5. Start and run the engine for 30 minutes.
6. Stop the engine and drain the cleaning solution.
7. Flush the system with clean water, until draining water is clear.
8. Close the drain valve and install the block drain plug. Fill the system with neutralizing solution, 250g (1/2 lb) sodium carbonate per 40 liters (10 gallons) of water.
9. Start and run the engine for 10 minutes.
10. Stop the engine and drain the neutralizing solution.
11. Flush the system with clean water until draining water is clear.
12. Close the drain valve and install the block drain plug. Add coolant to the top of the filter neck.
13. Start and run the engine to stabilize the coolant level. See "Every 10 Service hours or Daily", "Coolant Level-Check", in this manual.

Fork – Inspect

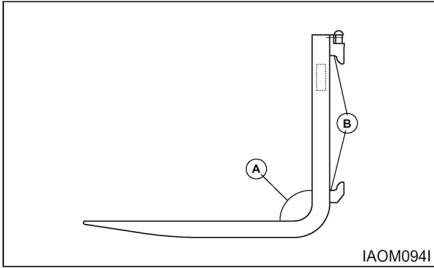

Forks should be inspected, at a minimum, every 12 months. If the truck is being used in a multi-shift or heavy duty operation, they should be checked every six months.

1. Inspect the forks carefully for cracks. Special attention should be given to the heel section (A), all weld areas and mounting brackets (B). Inspect the top and bottom hooks on forks used on hook type carriages and tubes on shaft mounted forks.

Forks with cracks should be removed from service. "Wet Test" magnetic particle inspection is generally preferred due to its sensitivity and the ease of interpreting the results. Portable equipment is usually recommended so it can be moved to the lift truck.

Inspectors should be trained and qualified in accordance with The American Society for Non Destructive Testing, Level II Qualifications.

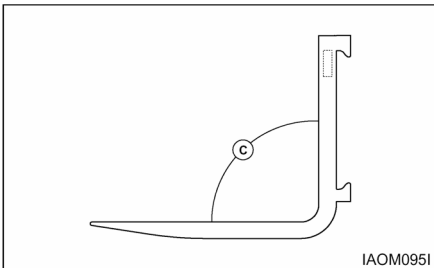

2. Check the angle between the upper face of the blade and the front face of the shank. The fork should be withdrawn from service if angle (C) exceeds 93 degrees or deviates by more than 3 degrees from an original angle other than 90 degrees, as may be found in some special application forks.

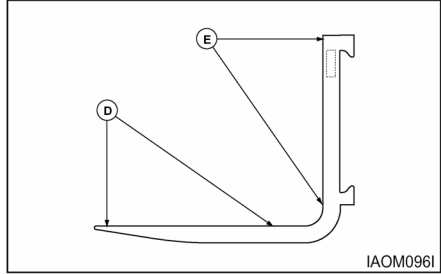

3. Check the straightness of the upper face of blade (D) and the front face of shank (E) with a straight edge.

The fork should be withdrawn from service if the deviation from straightness exceeds 0.5 percent of the length of the blade and/or the height of the shank respectively 5 mm/1000 mm (0.18"/36").

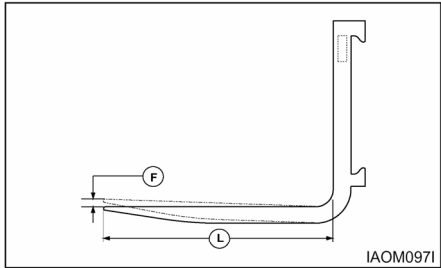

4. Check the difference in height of one fork tip to the other when mounted on the fork carrier. A difference in fork tip height can result in uneven support of the load and cause problems with entering loads.

The maximum recommended difference in fork tip elevation (F) is 6.5 mm (0.25") for pallet forks and 3 mm (0.125") for fully tapered forks. The maximum allowable difference in fork tip elevation between the two or more forks is 3 percent of blade length (L).

Replace one or both forks when the difference in fork tip height exceeds the maximum allowable difference. Contact your local DOOSAN Lift Truck Dealer for further information.

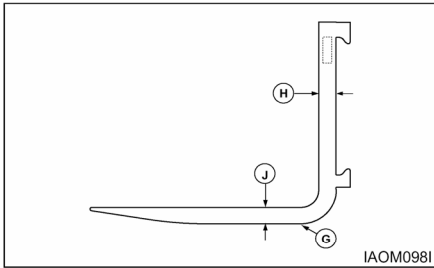

5. Check the fork blade (J) and shank (H) for wear with special attention to the heel (G). The fork should be withdrawn from service if the thickness is reduced to 90 percent or less of the original thickness.

Fork blade length may also be reduced by wear, especially on tapered forks and platens. Remove the forks from service when the blade length is no longer adequate for the intended loads.

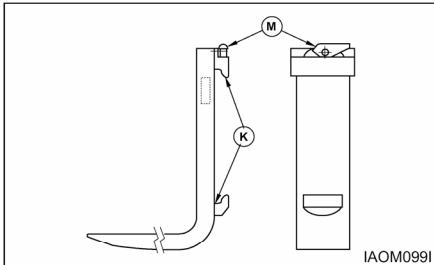

6. Check the fork mountings (K) for wear, crushing and other local deformation, which can cause excessive side to side wobble of the forks. Excessive clearance on hook type forks may allow them to fall from the carrier. Forks which show visible signs of such damage should be removed from service.
7. Check the positioning lock and other fork retention devices to make sure they are in place and working.

Hook type forks use a spring loaded pin (M), located in the top hook, to engage notches in the top carriage bar to hold the fork in place.

When adjusting the fork spacing, the forks are prevented from sliding off the end of the carriage by stop blocks. These stop blocks are at both ends of the carriage and in the path of the bottom fork hook. The load backrest extension may be used in place of the stop blocks in some cases.

Shaft mounted forks may use set collars or spacers on the shaft to either side of the fork. They may also use U bolts, pins, or similar devices which engage the fork through the top structure of the carriage.

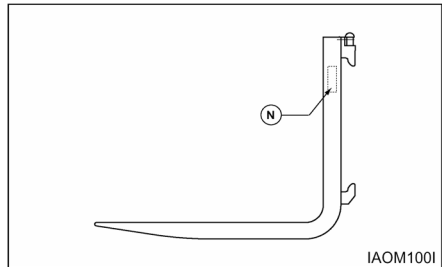

8. Check fork markings (N) for legibility. Renew markings as required to retain legibility.
9.
 - a. Lift the mast and operate the tilt control lever, until the top surface of the forks is parallel with the floor. Place two straight bars that are the same width as the carriage, across the forks as shown.
 - b. Measure the distance from the bottom of each end of the two bars to the floor. The forks must be parallel within 3 mm (.12 in) for Full Tapered and Polished (FTP) forks, all other forks 6.4 mm (.25 in), for their complete length.
 - c. Put one fork, one third from the tip, under a fixture that will not move. Then operate the tilt control with caution until the rear of the truck lifts just off the floor. Follow the same procedure with the second fork. Repeat Step a.

Every 2500 Service Hours or 15 Months

You must read and understand the warnings and instructions contained in the Safety section of this manual, before performing any operation or maintenance procedures.

Hydraulic Oil - Check, Clean, Change

⚠ WARNING

Hot oil and components can cause personal injury. Do not allow hot oil or components to contact skin.

Park the lift truck level with the forks lowered, mast tilted back (all cylinders retracted), parking brake engaged, transmission in NEUTRAL and the engine stopped.

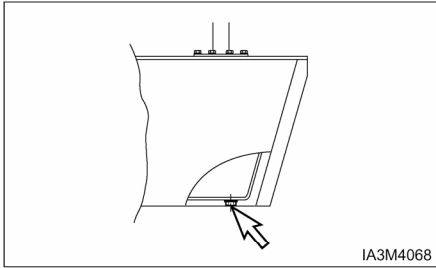

6. Stop the engine and check the oil level. With all cylinders retracted, maintain the oil level to the FULL mark on the dipstick.

1. Remove the hydraulic tank drain plug. Allow the oil to drain. Clean and install the plug.
2. Raise the hood and seat assembly.
3. Remove dipstick/filter cap. Fill the hydraulic tank. See "Refill Capacities." Install the breather/dipstick.
4. Lower the hood and seat assembly.
5. Start the engine and operate the hydraulic controls, and the steering system, through a few cycles to fill the lines. Look for oil leaks.

Inspect Battery System

1. Clean battery outer surfaces with a mixture of baking soda and water.
2. Inspect battery outer surfaces for damage and replace as necessary.
3. Remove battery cable and clean, repair and/or replace as necessary.



Checking the TMAP Sensor (G643E Engine Only)

1. Verify that the TMAP sensor (5) is mounted tightly into the manifold adapter (6), with no leakage.
2. If the TMAP is found to be loose, remove the TMAP retaining screw and the TMAP sensor from the manifold adapter.
3. Visually inspect the TMAP O-ring seal for damage. Replace as necessary.
4. Apply a thin coat of an approved silicon lubricant to the TMAP o-ring seal.
5. Re-install the TMAP sensor into the manifold adapter and securely tighten the retaining screw.

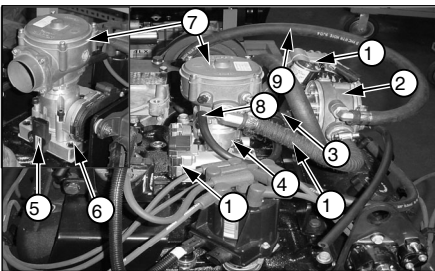

- (1) LP fuel lock-off, (2) LP regulator/converter
 (3) Fuel Trim Valve(FTV), (4) Adapter-Throttle body
 (5) TMAP sensor, (6) Adapter-Manifold, (7) LP mixer
 (8) Vacuum lines, (9) Coolant lines, (10) LP fuel line
 (11) Throttle body

Inspect for Intake Leaks (G643E Engine Only)

1. Visually inspect the intake manifold, throttle assembly (11), and manifold adapters (6), for looseness and leaks. Repair as necessary.

Replace PCV Valve and breather element - Change (LP-Gas Engine Only)

1. Loosen the hose clamps and remove the PCV valve.
2. Assemble new PCV valve and hose.
3. Tighten the hose clamps

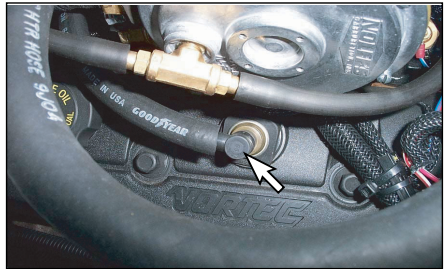

Every 4500 Service Hours or two Years

Replace Oxygen Sensor (G643E Engine Only)



1. Stop engine and wait until the exhaust pipe and exhaust pipe is cooled.
2. Disconnect the electrical connector of oxygen sensor
3. Remove oxygen sensor
4. Assemble new oxygen sensor Tightening torque :
45 N•m (32.5 lb•ft)
5. Connect the electrical connector of oxygen sensor

Index

#

12 Months Inspection..... 103

A

Accelerator Pedal58
 Adjustments88
 Advanced Diagnostics.....76
 After Starting the Engine67
 Air Breather – Change..... 152
 Air Cleaner Indicator – Check 126
 Air Intake System – Change..... 151
 Air Intake System – Check, Clean.....136
 Air–205 kPa (30 psi) Maximum Pressure 138
 Antifreeze 108
 Attachment Abbreviations (Includes Special Forks)...50
 Auto Shift Controller ASC – 200 (If Equipped)88
 Automatic mode.....89
 Avoiding Lift Truck Tipovers21

B

Basic Troubleshooting69
 Battery Terminal – Clean, Inspect..... 142
 Before Operating the Lift Truck12
 Before Starting the Engine.....63
 Before Starting the Lift Truck.....11
 Before Storage.....97
 Belts (Diesel Engine Only) – Check, Adjust 144
 Bent or Twisted Forks 101
 Bleeding the Fuel System 120
 Brake Fluid.....113
 Brake Pedal Adjustment Warning..... 8
 Bulbs..... 122
 Burn Prevention15

C

Capacity Chart 37,38,41,42,45
 Capacity Chart (with Side Shifter) 39,40,43,44,46
 Carburetor (LP – Gas Engine Only) – Adjust, Clean 150
 Carriage Roller Extrusion – Check, Adjust 124
 Carriage Side Rollers – Lubricate.....141
 Carriage Side Rollers Thrust (If Equipped) – Lubricate 146
 Carriage Sideshifter (If Equipped) – Lubricate 146
 Causes of Fork Failure 101
 Center of Gravity (CG).....21
 Changing LP–Gas Tanks61
 Changing Primary Element 151
 Changing Secondary Element..... 151
 Chassis Pivot Eyebolts 145
 Check Coolant Level 125

Check for Equal Tension 153
 Check Inflation and Damage 123
 Checking Element 138
 Checking Service Indicator.....126
 Checking the TMAP Sensor (G643E Engine Only) ...165
 Circuit Breaker..... 55
 Circulation Pump Belt (OCDB & LP–Gas Engine Only) –
 Check, Adjust 147
 Cleaning Primary Filter Elements 138
 Coolant Information 107
 Coolant Level – Check, Clean.....125
 Coolant Water 108
 Cooling System – Clean, Change 161
 Cooling System Specifications..... 107
 Crosshead Rollers – Inspect..... 146
 Crushing or Cutting Prevention..... 14
 Cylinder Rod Extension145

D

Daily Inspection 102
 Detergent..... 138
 Diagnostics Features..... 89
 Diesel (24V)..... 67
 Diesel (24V) – LED Type..... 51
 Diesel Engine.....65,150
 Diesel Engine Crankcase..... 129
 Diesel Engine Equipped 60
 Diesel Specifications109
 Difficult to Start 70
 Direction Control Lever 57
 Direction Inhibit Point (SW2)..... 88
 Disassembly.....157
 Display for Operator..... 89
 Display for Troubleshooting..... 89
 Displaying Fault Codes (DFC) From SECM Memory . 77
 Drive Axle Oil112
 Drive Axle Oil – Check, Clean, Change.....132
 Drive Axle Oil & Strainer (OCDB Only) – Check, Clean,
 Change147
 Drive Axle Oil (Shoe Brake Only) – Check, Clean,
 Change156
 Drive Axle Oil Level – Check139
 Drive Wheels143

E

Electrical Disconnect Switch (If Equipped)..... 55
 Engine Compartment 54
 Engine Oil & Filter – Change 142,148
 Engine Oil & Filter (Diesel Engine Only) – Change...129
 Engine Oil (DEO and EO)111
 Engine Oil Level – Check125
 Engine Valve Lash (Diesel Engine Only) – Check,

Index Section

Adjust.....	118
Environment Management.....	3
Environment Protection.....	100
Every 10 Service Hours or Daily.....	125
Every 1000 Service Hours or 6 Months.....	150
Every 1500 Service Hours or 9 Months.....	156
Every 2000 Service Hours or Yearly.....	159
Every 250 Service Hours or Monthly.....	136
Every 2500 Service Hours or 15 Months.....	164
Every 4500 Service Hours or two Years.....	166
Every 500 Service Hours or 3 Months.....	144
Excessive Fuel Consumption/LPG Exhaust Smell.....	75

F

Falling Objects Protective Structure(FOPS).....	14
Fatigue.....	101
Features.....	88
Fire or Explosion Prevention.....	15
First 250 Service Hours or a Month.....	135
First 50 – 100 Service Hours or a Week.....	129
First Installation.....	102
Fluid Penetration.....	14
Foreword.....	2
Fork – Inspect.....	162
Fork Inspection.....	102
Fuel Filter (LP – Gas Engine Only).....	157
Fuel Filters – Change.....	150
Fuel Lines & Fittings – Check.....	152
Fuel Specifications.....	109
Fuel Sulfur Content.....	109
Fuel Trim Valve(FTV) Inspection (G643E Engine only).....	149
Fuel Types.....	109
Fuse & Relay (G643E Only).....	122
Fuses.....	121
Fuses, Bulbs & Circuit Breaker – Change, Reset.....	121

G

G643E Electronic Controlled LP Engines (If Equipped).....	68
General Description.....	68
General Fuel Information.....	109
General Hazard Information.....	10
General Section.....	1
General Warnings to Operator.....	6

H

Hand Placement Warning.....	7
High Idle Speed.....	74
Hook – on type Fork.....	96
Horn & Lights (If Equipped) – Check.....	148
How to Survive in a Tipover (If Operator Restraint System Equipped).....	28
Hydraulic Oil – Check, Clean, Change.....	164

Hydraulic Oil (HYDO).....	111
Hydraulic Oil Level – Check.....	139
Hydraulic Return Filter – Change.....	135,152
Identification, Lift Capacity and Attachment Plate... If Optional Suspension Seat (weight adjusting type) Equipped.....	49 19

I

Important Safety Information.....	4
Improper Modification or Repair.....	101
Inching.....	87
Inching & Brake Control shaft – Lubricate.....	148
Inching into Loads.....	91
Index.....	167
Index Section.....	1
Information Section.....	1
Inspect Mixer Assembly (G643E Engine Only).....	152
Inspect Acceleration Pedal Operation(G643E Only).....	126
Inspect Battery System.....	165
Inspect Coolant Hoses (LP Engines Only).....	151
Inspect Electrical System (G643E Engine only).....	149
Inspect Engine for Exhaust Leaks.....	126
Inspect Engine for Fluid Leaks.....	125
Inspect for Intake Leaks (G643E Engine Only).....	165
Inspect Ignition System (LP–Gas Engine Only).....	156
Inspect Throttle Assembly (G643E Engine Only).....	152
Inspect Tightness.....	143
Inspect Vacuum Lines and Fittings (G643E Engine only).....	148
Inspection, Maintenance and Repair of Lift Truck Forks.....	100
Instrument Panel.....	51

L

Lift Chain Adjustment.....	153
Lift Chain Wear Test.....	153
Lift Chains – Test, Check, Adjust.....	153
Lift Control.....	58
Lift Fork Adjustment.....	96
Lift Truck Capacity Rating.....	49
Lift Truck Controls.....	57
Lift Truck Operation.....	86
Lift Truck Parking.....	13
Lift Truck Shipping.....	98
Lift Truck Stability.....	21
Lift Truck Stability Base.....	22
Lifting Drums or Round Objects.....	94
Lifting the Load.....	91
Literature Information.....	2
Load Backrest Must Be In Place Warning.....	7
Loading or Unloading Trucks/Trailers.....	13
Long Time Storage.....	97
Low–High Shift Point (SW1).....	88
LP Regulator/Converter Inspection (LP Engine Only).....	151
LPG/GAS (12V).....	51

LPG/GAS (12V)	67
LP-Gas Engine	66
LP-Gas Engine Crankcase	142
LP-Gas Specifications	110
Lubricant Information	111
Lubricant Specifications	111
Lubricant Viscosities	114
Lubricant Viscosities and Refill Capacities	114
Lubricating Grease (MPGM)	113

M

Machine Lifting and Tiedown Information	98
Maintenance	3
Maintenance and Repair	103
Maintenance Information	14
Maintenance Intervals	3
Maintenance Section	1
Make proper antifreeze additions	108
Manual Mode (Fail-Safe mode)	90
Mast Abbreviations	50
Mast Channels – Lubricate	128
Mast Hinge Pins – Lubricate	144
Mast Pivot Eyes	145
Mast, Carriage, Lift Chains, & Attachments – Check, Lubricate	140
Metric Hardware	105
Metric ISO2 Tread	106
Mounting and Dismounting	11
Moving Fan Warning	9

N

No Riders Warning	9
No Standing On Forks Warning, No Standing Under Forks Warning	7
Noise	36
Noise and Vibration	36

O

Oil Cooled Disc Brake (OCDB)	112
Oil Cooled Disc Brake (OCDB) Type	132,140
Oil Cooled Disc Brake Only	113
Operating in hot weather	94
Operating Techniques	91
Operating the Lift Truck	12
Operation	2,89
Operation Information	11
Operation Section	1
Operator Restraint System (If Equipped)	2,17
Operator's Station and Monitoring Systems	51
Operator's Warning Plate	49
Operator's Warning and Identification Plate	49
Overhead Guard – Inspect	149
Overhead Guard Must Be In Place Warning	8
Overloading	101

P

Parking brake	9
Parking Brake – Test, Adjust	133,147
Parking Brake Lever	58
Parking the Lift Truck	95
Poor High Speed Performance	74
Power Shift Transaxle	86
Precleaner (If Equipped)	136
Pressure Air	14
Pressure Warning	7
Prestart Conditions	65
Priming the Fuel System (Diesel Engine Only)	120
Product Description	88

R

Reading Diagnostic Fault Codes	76
Refill Capacities	114
Refueling	60
Replace LP Fuel Filter Element (LP-Gas Engine Only)	157
Replace Oxygen Sensor (G643E Engine Only)	166
Replace PCV Valve and breather element – Change (LP-Gas Engine Only)	165
Replace Spark Plugs (LP-Gas Engine Only)	156

S

Safety	2,5
Safety Rules	23
Safety Section	1
Seat	55
Seat Adjustment	18
Seat Switch System	56
Seat, Hood Latch & Support Cylinder – Check, Lubricate	120
Serial Number	47
Serial Number Locations	47
Service Brake Pedal	58
Servicing Filter Element	136
Shoe Brake	112
Shoe Brake Type	132,139
Sideshift Attachment Control (If Equipped)	59
Specifications	30,32,34
Stability and Center of Gravity	21
Starting a Cold Diesel Engine	65
Starting a Warm Diesel Engine	65
Starting From a 12 Volt External Source	66
Starting the Engine	65
Starting the Lift Truck	12
Steer Suspension – Inspect	149
Steer Wheel Bearings – Reassemble	159
Steer Wheels	143
Steering Mechanism – Check, Lubricate	141
Storage Information	97

Index Section

T

Table a. MI-04 Diagnostic Fault Codes (Flash Codes)	78,79,80,81,82,83,84,85
Table of Contents	1
Test Fuel System for Leaks (LP Engine Only)	119
Testing Fuel Lock-off Operation (LP-Gas Engine Only)	158
TIER I Diesel Engine(DB58)	142
TIER II Diesel Engine (DB58S) Only	148
Tilt Control	59
Tilt Cylinders – Check, Adjust, Lubricate	145
Tilt Steering Column	55
Tire Inflation	104
Tire Inflation Information	104
Tire Inflation Pressures Adjustment	104
Tire Shipping Pressure	104
Tires and Wheels – Check, Inspect	123
To Adjust	134
To Operate the Lift Truck After a Long Time Storage	97
Torque for Metric Fasteners	106
Torque for Standard Bolts, Nuts, and Taperlock Studs	105
Torque for Standard Hose Clamps – Worm Drive	105
Torque Specifications	105
Torques for Bolts and Nuts With Standard Threads	105
Torques for Taperlock Studs	106
Towing Information	99
Training Required to Operate or Service Warning	5
Transmission Inching Control Pedal	57
Transmission Oil (TDTO)	112
Transmission Oil Level – Check	128
Transmission Oil, Oil Filter & Strainer – Clean, Change	130
Transmission Oil, Oil Filter & Strainer – Clean, Change	152
Transmission Speed Range Lever	57
Transportation Hints	98
Traveling With the Load	92
Turning	93
Wheel Bolts and Nuts – Inspect	143
When Required	115,118
Will Not Run Continuously	71

U

Universal Joint (Diesel Engine Only) – Inspect	155
Unloading	92

V

Vibration(weighted overall value)	36
-----------------------------------	----

W

Walk – Around Inspection – Inspect	127
Walk-Around Inspection	63
Warning Signs and Labels	5,17
Water Separator (Diesel Engine Only) – Drain	118
Water-280 kPa (40 psi) Maximum Pressure	138