

Operator's Manual



INTERNAL COMBUSTION LIFT TRUCKS

[Do not remove this manual from the truck]

C 40/45/50s/55s D,L

C 60/70/75/80 D,L



Part No. 8131796 (Eng)
Book No. OM 1038 (Rev 2.6)
Aug. 2021

Operator's Manual

You must be trained and authorized to operate a lift truck.

YOU can prevent accidents

First: Learn safe operating rules and your company rules.

Next: Read your Operator's Manual. If you do not understand it, ask your supervisor for help.

Learn about the unit you operate.

KNOW YOUR TRUCK

Then: Practice operating your truck safely.

And: Keep your truck in safe operating condition with correct and timely maintenance.

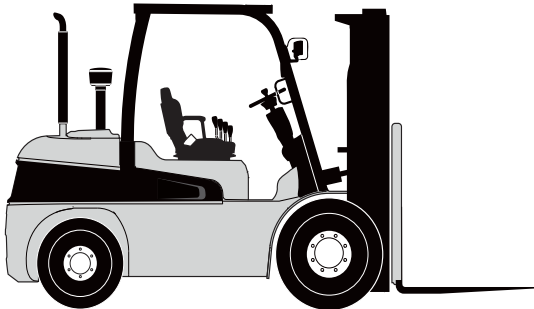

Breaking these rules will cause serious or fatal injury to yourself and others.



A Message to CLARK Lift Truck Operators

Lift trucks are specialized machines with unique operating characteristics, designed to perform a specific job. Their function and operation is not like a car or ordinary truck. They require specific instructions and rules for safe operation and maintenance.

Safe operation of lift trucks is of primary importance to CLARK. Our experience with lift truck accidents has shown that when accidents happen and people are killed or injured, the causes are:

- **Operator not properly trained**
- **Operator not experienced with lift truck operation**
- **Basic safety rules not followed**
- **Lift truck not maintained in safe operating condition**

For these reasons, CLARK wants you to know about the safe operation and correct maintenance of your lift truck.

This manual is designed to help you operate your lift truck safely. This manual shows and tells you about safety inspections and the important general safety rules and hazards of lift truck operation. It describes the special components and features of the truck and explains their functions. The correct operating procedures are shown and explained. Illustrations and important safety messages are included for clear understanding. A section on maintenance and lubrication is included for the lift truck mechanic.



The operator's manual is not a training manual. It is a guide to help trained and authorized operators safely operate their lift truck by emphasizing and illustrating the correct procedures. However, it cannot cover every possible situation that may result in an accident. You must watch for hazards in your work areas and avoid or correct them. It is important that you know and understand the information in this manual and that you know and follow your company safety rules! Be sure that your equipment is maintained in a safe condition. Do not operate a damaged or malfunctioning truck. Practice safe operation every time you use your lift truck. Let's join together to set high standards in safety.

Remember, before you start operating this lift truck, be sure you understand all driving procedures. It is your responsibility, and it is important to you and your family, to operate your lift truck safely and efficiently. Be aware that the Federal Occupational Safety and Health Act (OSHA) and state laws require that operators be completely trained in the safe operation of lift trucks; it is also an OSHA requirement that a machine inspection be performed before every shift. If you think you need training in operating or inspecting your lift truck, ask your supervisor.

CLARK lift trucks are built to take hard work, but not abuse. They are built to be dependable, but they are only as safe and efficient as the operator and the persons responsible for maintaining them. Do not make any repairs to this truck unless you have been trained in safe lift truck repair procedures and are authorized by your employer.



CAUTION

This forklift burns propane (LPG) which will produce exhaust gases that are harmful to humans. They include carbon monoxide, carbon dioxide, nitrogen oxides and hydrocarbons. The amounts of each of these gases will vary, depending on a number of related factors. With the correct fuel, proper tuning of the system by technicians and adequate ventilation, this truck can produce emissions that are considered safe for indoor use. Of the four gases, carbon monoxide poses the greatest threat. Carbon monoxide symptoms may vary with individuals, depending on breathing rate, the amount of work or exercise being performed at the time of exposure, and the physical state of the subject. In case of working in an enclosed area, the area should be well ventilated. We recommend the forklift not be operated in a small enclosed area for long periods. To maintain the emission levels to a normal level, customers are requested to follow the maintenance schedule. A truck using diesel fuel is not recommended indoor use.



SAFETY STARTS WITH YOU
(Safety DVD)



2840950



Contents of this Manual

A Message to CLARK Lift Truck Operators.....	ii
Introduction	vi
How to Use this Manual	viii
Safety Signs and Safety Messages	x
Section 1. General Safety Rules	1-1
Section 2. Operating Hazards	2-1
Section 3. Operator Compartment and Controls	3-1
Section 4. Operating Procedures	4-1
Section 5. Operator Maintenance and Care	5-1
Section 6. Emergency Starting and Towing	6-1
Section 7. Planned Maintenance and Lubrication	7-1
Section 8. Specifications	8-1



Introduction

CLARK welcomes you to the growing group of professionals who own, operate, and maintain CLARK lift trucks. We take pride in the long tradition of quality products and superior value the CLARK name represents. This manual familiarizes you with safety, operating, and maintenance information about your new lift truck. It has been specially prepared to help you use and maintain your CLARK lift truck in a safe and correct manner.

Your CLARK lift truck has been designed and built to be as safe and efficient as today's technology can make it. As manufactured, it meets all the applicable mandatory requirements of ANSI / ITSDF B56.1 Safety Standard for Powered Industrial Trucks. Each truck is also furnished with equipment to help you operate safely; for example, load back rest, parking brake, safety restraint system, seat belts and horn are standard equipment.

Safe, productive operation of a lift truck requires both skill and knowledge on the part of the operator. The operator must know, understand, and practice the safety rules and safe driving and load handling techniques described in this manual. To develop the skill required, the operator must become familiar with the construction and features of the lift truck and how they function. The operator must understand its capabilities and limitations, and see that it is kept in a safe condition.

Routine Servicing and Maintenance

Regular maintenance and care of your lift truck are not only important for economy and utilization reasons; it is essential for your safety. A faulty lift truck is a potential source of danger to the operator, and to other personnel working near it. As with all quality equipment, keep your lift truck in good operating condition by following the recommended schedule of maintenance.



Operator Daily Inspection — Safety and Operating Checks

A lift truck should always be examined by the operator, before driving, to be sure it is safe to operate. The importance of this procedure is emphasized in this manual with a brief illustrated review and later with more detailed instructions. CLARK dealers can supply copies of a helpful “Drivers Daily Checklist.”

Planned Maintenance

In addition to the daily operator inspection, CLARK recommends that a planned maintenance and safety inspection program (PM) be performed by a trained and authorized mechanic on a regular basis. The PM will provide an opportunity to make a thorough inspection of the safety and operating condition of your lift truck. Necessary adjustments and repairs can be done during the PM, which will increase the life of components and reduce unscheduled downtime and increase safety. The PM can be scheduled to meet your particular application and lift truck usage.

The procedures for a periodic planned maintenance program that covers inspections, operational checks, cleaning, lubrication, and minor adjustments are outlined in this manual. Your CLARK dealer is prepared to help you with a Planned Maintenance Program by trained service personnel who know your lift truck and can keep it operating safely and efficiently.

Modification of the truck prohibited

Unauthorized modification of the truck is not permitted, and, in case that a problem has occurred due to a modification without permission, the warranty service shall not be provided.

For instance, the modifications which may void the warranty include those that may negatively affect the performance, durability and safety of the truck due to addition of unauthorized electrical devices (lamp, black box, electrical instrument, communication equipment, etc.), braking system, steering system, vision improvement system and detachable attachment device that were not mounted when the equipment was shipped out of the factory.

How to Use this Manual

This manual is a digest of essential information about the safe operation, the features and functions and explains how to maintain your lift truck. This manual is organized into eight major parts:

Section 1, General Safety Rules, reviews and illustrates accepted practices for safe operation of a lift truck.

Section 2, Operating Hazards, warns of conditions that could cause damage to the truck or injury to the operator or other personnel.

Section 3, Operator Compartment and Controls, describes the operating components, systems, controls, and other features of your truck and tells how they function.

Section 4, Operating procedures, discusses specific instructions on the safe, efficient operation of your lift truck.

Section 5, Operator Maintenance and Care, presents details on how to perform the operator's daily safety inspection and refuel the lift truck.

Section 6, Emergency Starting and Towing, gives instructions for towing your truck in an emergency and for using battery jumper cables to start your truck in an emergency.

Section 7, Planned Maintenance and Lubrication, describes the PM program.

Section 8, Specifications, provides reference information and data on features, components, and maintenance items.

NOTICE: The descriptions and specifications included in this manual were in effect at the time of printing. CLARK Material Handling Company reserves the right to make improvements and changes in specifications or design. Please check with your authorized CLARK dealer for information on possible updates or revisions.

The examples, illustrations, and explanations in this manual should help you improve your skill and knowledge as a professional lift truck operator and take full advantage of the capabilities and safety features of your new lift truck.

The first Section of the manual is devoted to a review, with illustrations and brief messages, of general safety rules and the major operating hazards you can encounter while operating a lift truck. Next, you will find descriptions of the components of your specific lift truck model and how the instruments, gauges, and controls operate. Then, you will find a discussion of safe and efficient operating procedures, followed by instructions on how to tow a disabled lift truck. The later sections of the manual are devoted to maintenance and truck specifications.

Take time to carefully read the “Operator Compartment and Controls” section. By acquiring a good basic understanding of your truck’s features, and how they function, you are better prepared to operate it both efficiently and safely.

In “Planned Maintenance and Lubrication,” you will find essential information for correct servicing and periodic maintenance of your truck, including charts with recommended maintenance intervals and component capacities. Carefully follow these instructions and procedures.

Each major Section has its own table of contents, so that you can find the various topics more easily. If you cannot find a topic in the table of contents, check the index at the back of the manual.

We urge you to first carefully read the manual from cover to cover. Take time to read and understand the information on general safety rules and operating hazards. Acquaint yourself with the various procedures in this manual. Understand how all gauges, indicator lights, and controls function. Please contact your authorized CLARK dealer for the answers to any questions you may have about your lift truck’s features, operation, or manuals.

Operate your lift truck safely; careful driving is your responsibility. Drive defensively and think about the safety of people who are working nearby. Know your truck’s capabilities and limitations. Follow all instructions in this manual, including all IMPORTANT, CAUTION, WARNING, and DANGER messages to avoid damage to your lift truck or the possibility of any harm to yourself or others.

This manual is intended to be a permanently attached part of your lift truck. Keep it on the truck as a ready reference for anyone who may drive or service it. If the truck you operate is not equipped with a manual, ask your supervisor to obtain one and have it attached to the truck. And, remember, your CLARK dealer is pleased to answer any questions about the operation and maintenance of your lift truck and will provide you with additional information should you require it.



Safety Signs and Safety Messages

Improper operation can cause accidents. Don't take chances with incorrect or damaged equipment. **Read** and **understand** the procedures for safe driving and maintenance outlined in this manual. Don't hesitate to ask for help. **Stay alert!** Follow safety rules, regulations, and procedures. Avoid accidents by recognizing dangerous procedures or situations before they occur. **Drive and work safely** and follow the safety signs and their messages on the truck and in this manual.

Safety signs and messages are placed in this manual and on the truck to provide instructions and identify specific areas where potential hazards exist and special precautions should be taken. Know and understand the meaning of these instructions, signs, and messages. Damage to the truck, death, or serious injury to you or other persons may result if these messages are not followed. If warning decals are damaged, they must be replaced. Contact your CLARK dealer for replacements.

NOTICE

This message is used when special information, instructions or identification are required relating to procedures, equipment, tools, pressures, capacities and other special data.

IMPORTANT

This message is used when special precautions should be taken to ensure a correct action or to avoid damage to or malfunction of the truck or a component.



CAUTION

Indicates a potentially hazardous situation which, if not avoided, may result in minor or moderate injury. It may also be used to alert against unsafe practices.



WARNING

Indicates a potentially hazardous situation which, if not avoided, could result in death or serious injury.



DANGER

Indicates an imminently hazardous situation which, if not avoided, will result in death or injury



General Safety Rules

Contents

Contents	1-1
Daily Inspection	1-2
Do's and Don'ts	1-3
Seat Belts	1-4
No Riders	1-5
Pedestrians	1-6
Operator Protection	1-7
Fork Safety	1-8
Pinch Points	1-9
Travel	1-10
Grades, Ramps, Slopes, and Inclines	1-11
Surface and Capacity	1-12
Tip-Over	1-13
What to do in Case of a Tip-over	1-14
Parking	1-15
General Tire Maintenance, Inspection, and Repair	1-16
Carbon monoxide and fumes	1-17



Daily Inspection

CLARK Material Handling Company
 OPERATORS' DAILY CHECKLIST
 Check Each Item Before Start Of Each Shift

Date: _____

Check one: Gas/LPG/Diesel Truck Electric Sit-down Electric Stand-up Electric Pallet

Truck Serial Number: _____ Operator: _____ Supervisor's OK: _____

Hour meter reading: _____

Check each of the following items before the start of each shift. Let your supervisor and/or maintenance department know of any problem.
 DO NOT OPERATE A FAULTY TRUCK. Your safety is at risk.
 After checking, mark each item accordingly. Explain below as necessary.

Check boxes as follows: OK NG, needs attention, or repair. Circle problem and explain below

OK	NG	VISUAL CHECKS	OK	NG	OPERATIONAL CHECKS
<input type="checkbox"/>	<input type="checkbox"/>	Tires/Wheels: wear, damage, nuts tight	<input type="checkbox"/>	<input type="checkbox"/>	Engine: runs rough, noisy, leaks
<input type="checkbox"/>	<input type="checkbox"/>	Head/Tail-Working Lights: damage, mounting, operation	<input type="checkbox"/>	<input type="checkbox"/>	Steering: loose/binding, leaks, operation
<input type="checkbox"/>	<input type="checkbox"/>	Gauges/Instruments: damage, operation	<input type="checkbox"/>	<input type="checkbox"/>	Service Brake: linkage loose/binding, stops OK, grab
<input type="checkbox"/>	<input type="checkbox"/>	Operator Restraint: damage, mounting, operation, oily, dirty	<input type="checkbox"/>	<input type="checkbox"/>	Parking Brake: loose/binding, operational, adjustment
<input type="checkbox"/>	<input type="checkbox"/>	Warning Decals/Operator's Manual: missing, not readable	<input type="checkbox"/>	<input type="checkbox"/>	Seat Brake (if equipped): loose/binding, operational, adjustment
<input type="checkbox"/>	<input type="checkbox"/>	Data Plate: not readable, missing	<input type="checkbox"/>	<input type="checkbox"/>	Horn: operation
<input type="checkbox"/>	<input type="checkbox"/>	Overhead Guard: bent, cracked, loose, missing	<input type="checkbox"/>	<input type="checkbox"/>	Backup Alarm (if equipped): mounting, operation
<input type="checkbox"/>	<input type="checkbox"/>	Load Back Rest: bent, cracked, loose, missing	<input type="checkbox"/>	<input type="checkbox"/>	Warning Lights (if equipped): mounting, operation
<input type="checkbox"/>	<input type="checkbox"/>	Forks: bent, worn, stops OK	<input type="checkbox"/>	<input type="checkbox"/>	Lift/Lower: loose/binding, excessive drift, leaks
<input type="checkbox"/>	<input type="checkbox"/>	Engine Oil: level, dirty, leaks	<input type="checkbox"/>	<input type="checkbox"/>	Tilt: loose/binding, excessive drift, "chatters," leaks
<input type="checkbox"/>	<input type="checkbox"/>	Hydraulic Oil: level, dirty, leaks	<input type="checkbox"/>	<input type="checkbox"/>	Attachments: mounting, damaged, operation, leaks
<input type="checkbox"/>	<input type="checkbox"/>	Radiator: fluid level, dirty, leaks	<input type="checkbox"/>	<input type="checkbox"/>	Battery Test (electric trucks only): indicator in green while holding full forward tilt
<input type="checkbox"/>	<input type="checkbox"/>	Fuel: level, leaks	<input type="checkbox"/>	<input type="checkbox"/>	Control Levers: loose/binding, freely return to neutral
<input type="checkbox"/>	<input type="checkbox"/>	Battery: connections loose, charge, electrolyte low	<input type="checkbox"/>	<input type="checkbox"/>	Directional Control: loose/binding, find neutral OK
<input type="checkbox"/>	<input type="checkbox"/>	Covers/Sheetmetal: damaged, missing			
<input type="checkbox"/>	<input type="checkbox"/>	Brakes: linkage, reservoir fluid level, leaks, debris on floor			

Explanation of problems marked above:

59-770-2937

At the beginning of each shift, inspect your truck and fill out a daily inspection sheet.

Check for damage and maintenance problems.

Have repairs made before you operate the truck.



CAUTION

DO NOT MAKE REPAIRS YOURSELF. Lift truck mechanics are trained professionals. They know how to make repairs safely. (See Section 5)



Do's and Don'ts



Don't mix drugs or alcohol with your job.

Do watch for pedestrians.



Don't block safety or emergency equipment.

Do wear safety equipment when required.



Don't smoke in "NO SMOKING" areas or when refueling.

Don't use the similar fuel.

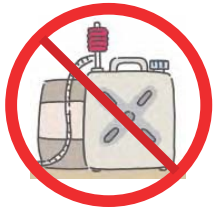

If forklift truck is to be operated outdoors during rainy conditions, make sure cab is in place to prevent damage to electrical components.

Seat Belts

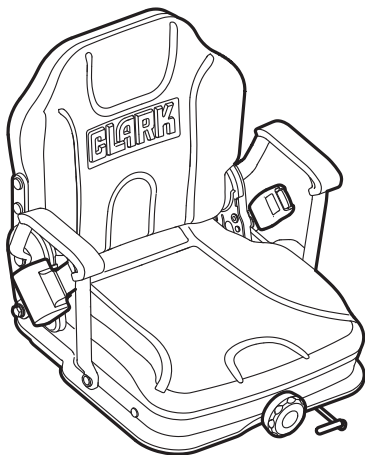

ALWAYS BUCKLE UP

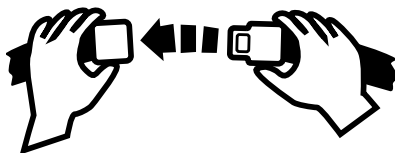

Seat belts can reduce injuries.

No Riders

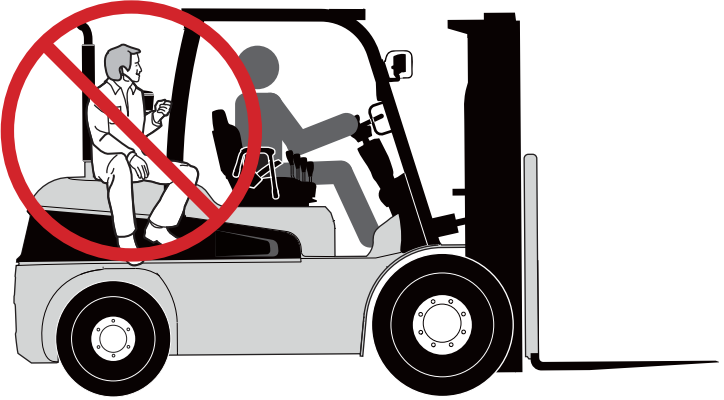

The operator is the only one who should be on a truck.

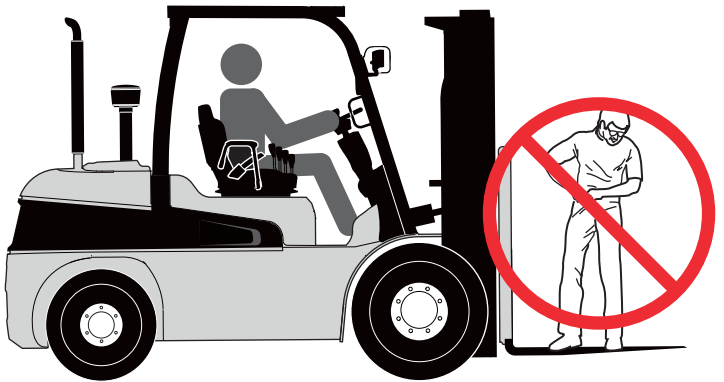

Never transport personnel on the forks of a lift truck.

Pedestrians

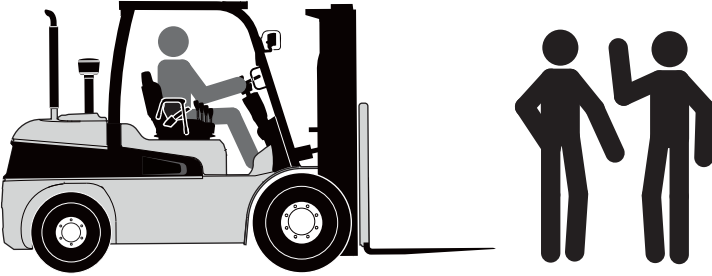

Watch where you are going. Look in the direction of travel. Pedestrians may use the same roadway you do. Sound your horn at all intersections or blind spots. Watch for people in your work area even if your truck has warning lights or alarms. People may not watch for you.



Make people stand back, even when you are parked.

Operator Protection

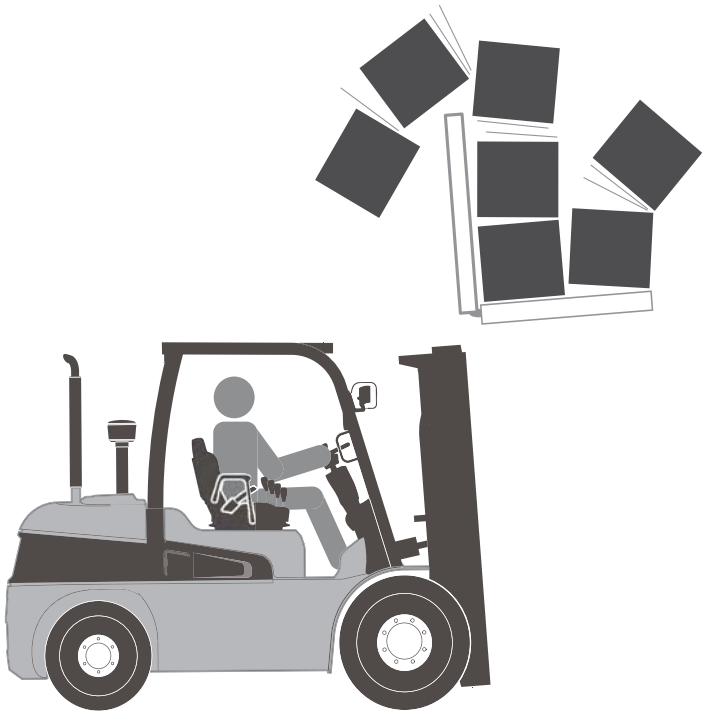

**Keep under the overhead guard.
Always keep your body within the confines of the truck.**

Fork Safety

Never allow anyone to walk under raised forks.



DANGER

There is special equipment to raise people for overhead work. **DO NOT USE LIFT TRUCKS.**



Pinch Points

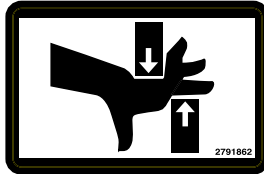

WARNING

Keep hands, feet and legs out of the upright.



WARNING

Don't use the upright as a ladder.



CAUTION

Never try to repair the upright, carriage, chain, or attachment yourself! Always get a trained mechanic.

Travel

Travel with the load near the floor/ground with upright tilted back to cradle the load whenever possible.

Never lift or lower the load when the truck is in motion.

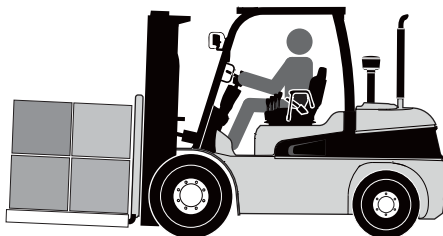

When handling bulky loads that restrict your vision operate your truck in reverse to improve visibility.

Be sure to pivot in the seat to give maximum visibility.



Unstable loads are a hazard to you and to your fellow workers.

Always make certain that the load is well stacked and evenly positioned across both forks.

Never attempt to lift a load with only one fork.

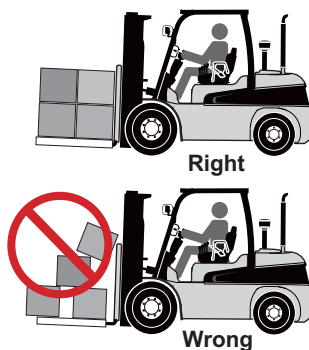

Grades, Ramps, Slopes, and Inclines

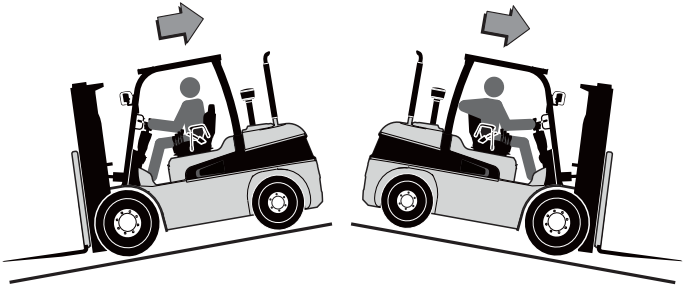

Unloaded



WARNING

Never turn on a grade, either loaded or unloaded.

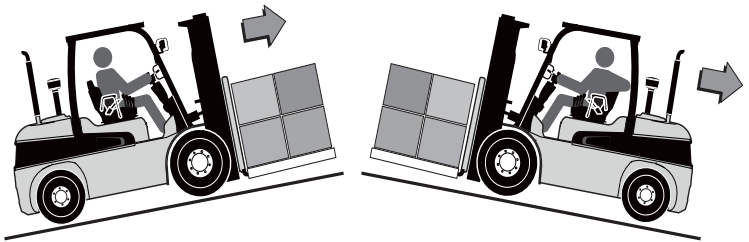

Loaded

Forks Upgrade

Surface and Capacity

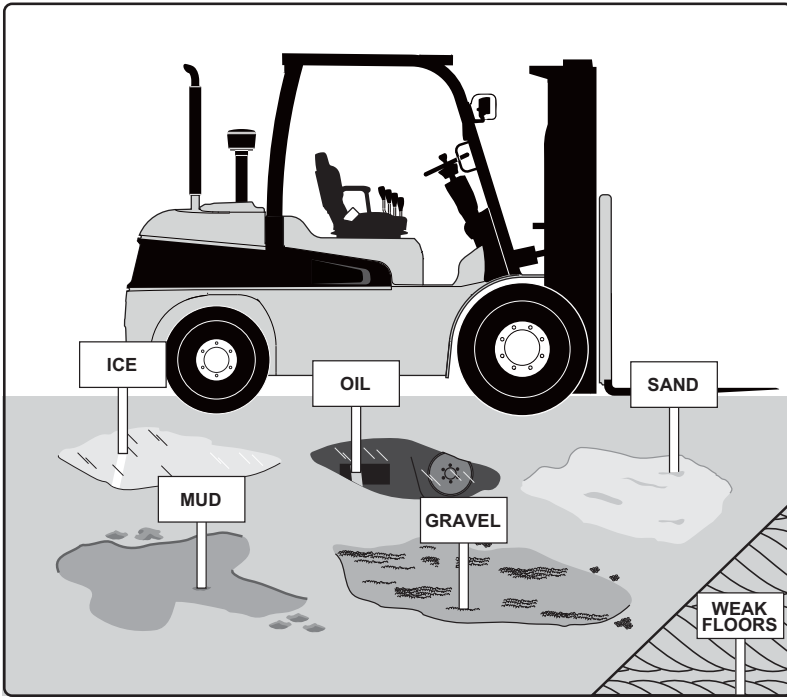

Avoid these conditions. They can cause a truck to tip over or lose traction for braking or driving.



WARNING

Know the weight of your truck and load. Especially when using elevators. Know the capacity of the elevator you intend to use. Do not overload.

IMPORTANT

Seat belts can reduce injuries.
ALWAYS BUCKLE UP

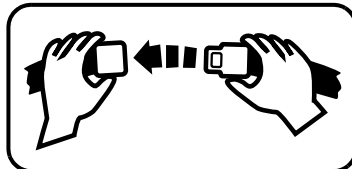

Tip-Over

Lateral Tip-over

- Lateral tip-over can occur with a combination of speed and sharpness of turn. This combination will exceed the stability of the truck. This condition is even more likely with an unloaded truck.
- With the load or upright raised, lateral tip-over can occur while turning and/or braking when traveling in reverse or accelerating and turning while traveling forward.
- Lateral tip-over can occur loaded or unloaded by turning on an incline or ramp.

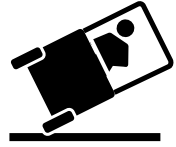

Longitudinal Tip-over

- Longitudinal tip-over can occur with a combination of overloading and load elevated also with capacity load and elevated. This combination will exceed the stability of the truck. This condition is even more likely with excessive forward tilt, braking in forward travel or accelerating rearward.
- Longitudinal tip-over can occur by driving with the load down slope on a steep grade.

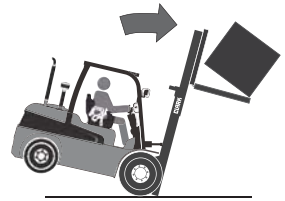

Lateral and longitudinal tip-over can occur if the truck is driven over objects on the floor or ground, off the edge of improved surfaces, or into potholes in the road surface, or by running into overhead objects or collisions.

An off dock type of tip-over can occur if the truck is steered too close to the dock edge, driven off the edge of the dock or ramp, or if the highway truck or trailer rolls away from the dock or is driven away during loading.



WARNING

The conditions listed above can be further aggravated by overloading, excessive tilt, or off center loads.

IMPORTANT

Lift truck tip-over can cause serious injury or death if the operator is trapped between the truck and the ground.

What to do in Case of a Tip-over

If your truck starts to tip over,

⚠ WARNING
DO NOT JUMP!!!

IMPORTANT

Your chances for survival in a tip-over are better if you stay with the truck, in your seat.

Brace yourself as illustrated below!

1. Make sure your seat belt is fastened securely.
2. Stay in your seat.
3. Grip the wheel.
4. Brace your feet.

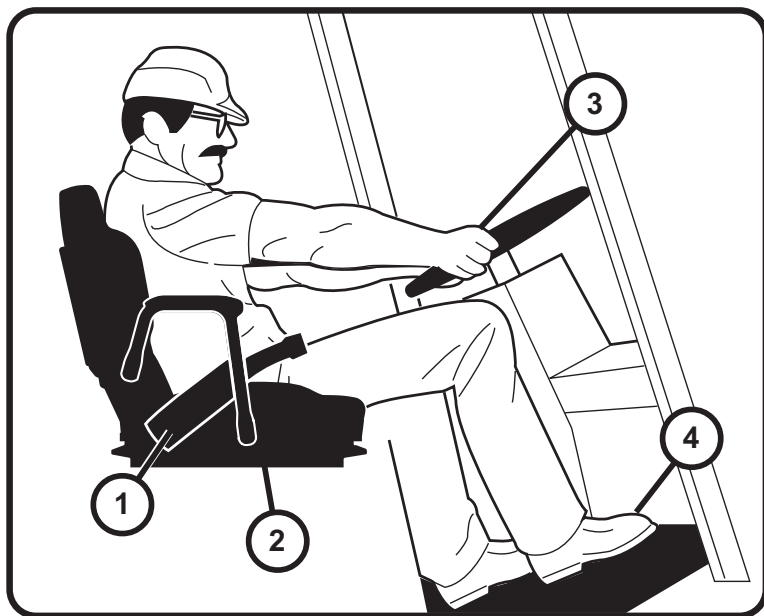

Parking

- Never park on a grade.
- Always come to a complete stop before leaving truck.



- Be sure travel control is in NEUTRAL.
- Lower forks fully to floor and tilt forward.



- Set parking brake.

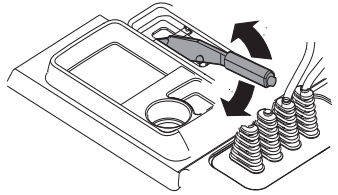

- Turn key to OFF position.

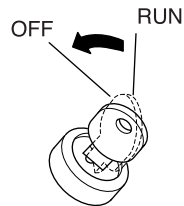

General Tire Maintenance, Inspection, and Repair

1. Park the truck as described on page 1-15 and check for correct tire inflation air pressure. See specifications in this OM for correct tire pressure for your truck.



CAUTION

Check tire pressure from a position facing the tread of the tire, not the side. Use a long-handled gauge to keep your body away from the side.



- If tires are low, do not add air. Have the tire and wheel inspected by a person trained and authorized to do tire and wheel maintenance. The tire may require removal and repair.
- Incorrect (low) tire pressure can reduce the stability of a lift truck and cause it to tip over.

IMPORTANT

Check wheels and tires for damage every time you check tire pressure. Make repairs when needed. Dirt can get into cuts and cause damage to the tire cord and tread. Remove debris from all cuts.



CAUTION

Multiple wheel assemblies. Do not loosen or remove wheel assembly nuts before fully deflating tire. Have only a trained and authorized mechanic make repairs. See *Service Manual* for more detailed information.

Carbon monoxide and fumes

Be sure your employees understand that they must not use an internal combustion engine in a closed area such as a cold storage locker. Carbon monoxide is a colorless, odorless, poisonous gas which can overcome your employees without warning. This gas is the product of incomplete burning of any material containing carbon, such as gasoline, LP and natural gas, and diesel fuel.

Internal combustion engines that use these fuels are sources of exposure in the workplace. Control of carbon monoxide levels in the workplace is dependent on ventilation and proper maintenance of carbon monoxide producers including internal combustion-powered equipment.

Properly running internal combustion engines will still produce carbon monoxide emissions and deplete the oxygen supply sufficiently, affecting the quality of ambient air in the work environment if the ambient air exchange is not adequate. Always use ventilation as the primary means of control by providing necessary air exchange capability.

Ventilation shall be provided in enclosed areas where internal combustion-powered equipment is used to maintain an atmosphere that shall not exceed the contamination levels specified by the American Conference of Governmental Industrial Hygienists, "Threshold Limit Values of Airborne Contaminants." (See 29 CFR 1910.1000 Table Z-1.) This includes the atmosphere within the truck cab when a cab is provided.

Common symptoms of carbon monoxide exposure may include headaches, dizziness, and nausea. If employees exhibit these symptoms, move them into fresh air, seek medical attention as required, and determine the source of carbon monoxide by monitoring "threshold limit values" in areas of exposure.

Questions concerning degree of concentration and methods of sampling to ascertain the conditions present should be referred to a qualified professional. Users must follow applicable local, state, and federal regulations that apply to their workplace.

Operating Hazards

Contents

Loose Loads	2-2
Long and Wide Loads / Rear Swing	2-3
Low Overhead Clearance	
Fast Turns and High Loads	2-4
Drop-Offs	2-5
Right-Angle Stacking	2-6
Chain Slack	2-7
Pallets and Skids	2-8

This Section shows some of the hazards that may cause you, or someone around you, to be killed or badly hurt. As the operator, you must look for other hazards. Get your supervisor to help you identify and avoid those hazards.



Loose Loads

Loose or unbalanced loads are dangerous. Observe these precautions.

Never carry loose or uneven material.

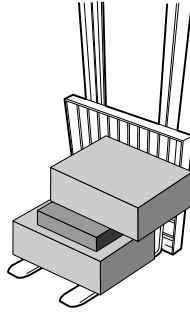

Center wide loads.

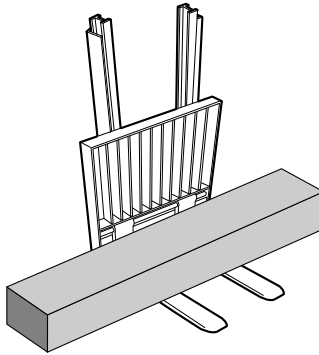

Stack and band loose material.

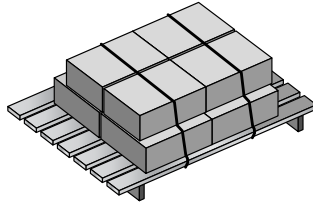

Long and Wide Loads / Rear Swing



WARNING

With long or wide loads, you need more room. So slow down and watch your clearance.

A long load reduces the capacity of the truck. Know and understand your truck load rating.

When extra-long material makes it necessary to travel with the load elevated, do so with extreme care and be alert to load end-swing when turning.

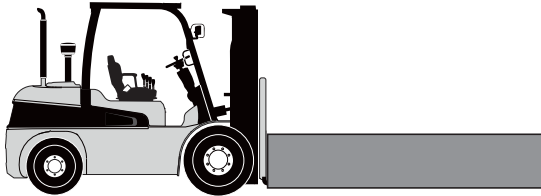

WARNING

When turning, be sure the rear end of the truck does not swing into racks, posts, etc. Watch for pedestrians beside the truck.



Low Overhead Clearance· Fast Turns and High Loads



WARNING

Know the height of your truck, with and without a load.

Check your clearances.

Keep the load low and tilted back.

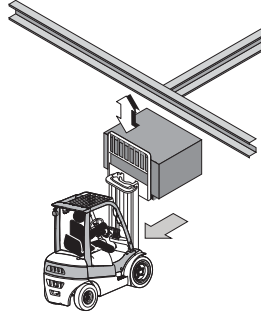

WARNING

Watch overhead clearance:

Moving into overhead structures can tip a truck over, or spill a load.

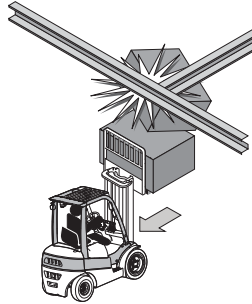

WARNING

Slow down before turning. The truck can tip over.

Turn too sharp with a raised load and your truck can tip even at slow speeds.

Travel with a load raised only when removing or depositing a load.



Drop-Offs

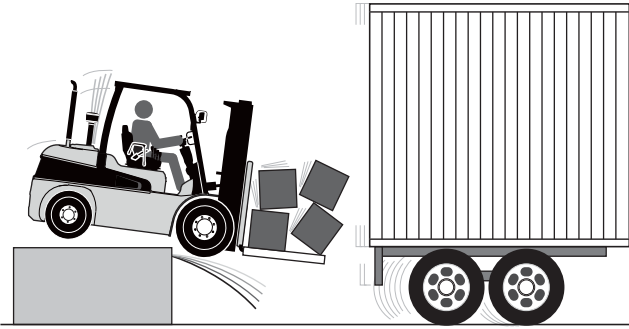

WARNING

To avoid these hazards, you must:

- Talk to the truck driver yourself; make sure the driver does not move the trailer until you are done!
- Apply trailer brakes.
- Use wheel chocks.
- Use trailer-to-dock locking system if available.

The impact of moving in and out of a trailer may cause the trailer to creep or move.



Right-Angle Stacking

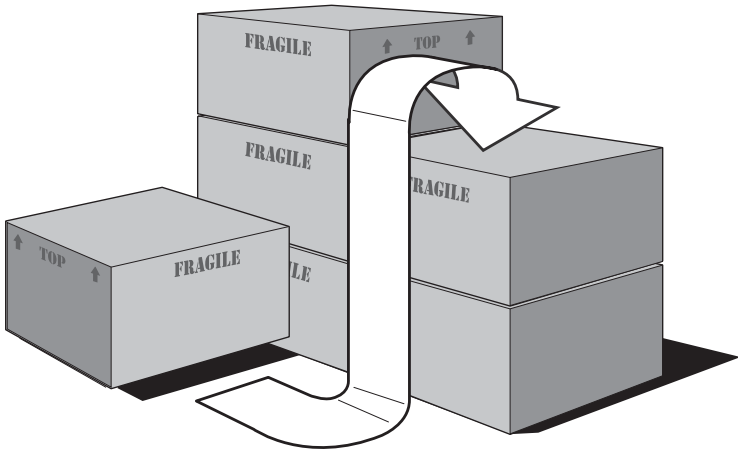

SLOWLY

When right-angle stacking or moving with a raised load to clear low objects, avoid sharp turns and move slowly.

Chain Slack

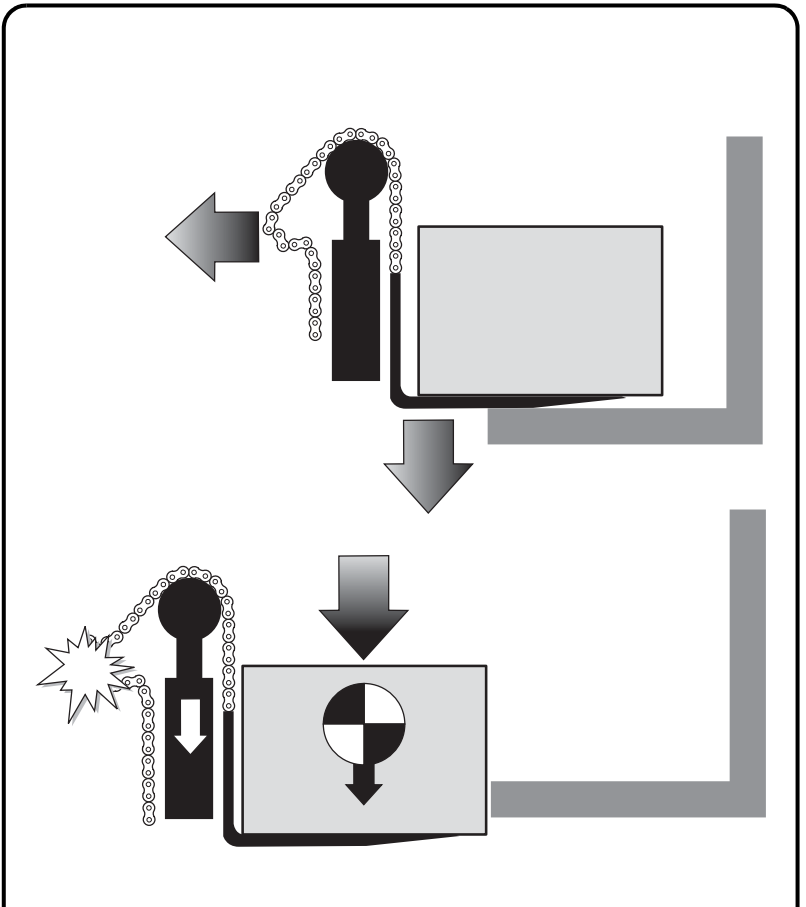

WARNING

Slack chains mean rail or carriage hang-up. Raise the forks before you move, or broken chains can result.

Pallets and Skids

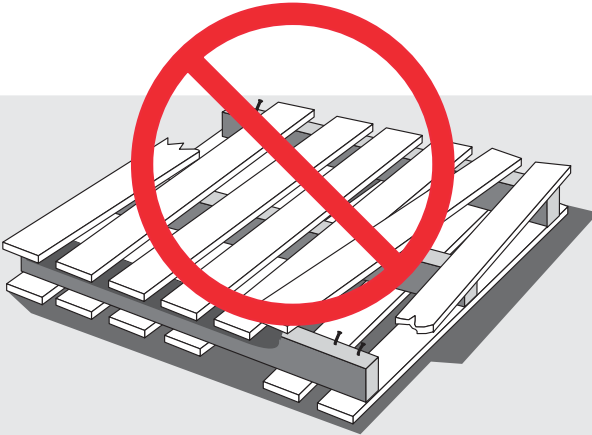

WARNING

Do not move or store materials on damaged pallets or skids. Items can fall through them causing severe injury or death!

Be sure the pallet or skid you are using is in good condition and does not have defective or missing components and fasteners.

Operator Compartment and Controls

Contents

Truck Description	3-2
Operator Compartment	3-3
Instrument Pod	3-4
Pod Symbols and Functions	3-5
Urea(SCR) System(C60-80D, Doosan)	3-12
Operator Controls	3-20



Truck Description

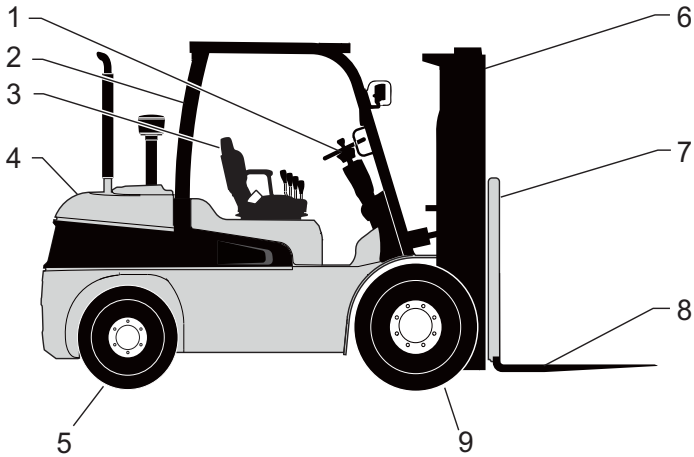

1. Steering Handwheel
2. Overhead Guard
3. Seat and Seat Belt
4. Counterweight
5. Steer Axle, Wheels / Tires
6. Upright and Carriage
7. Load Backrest
8. Forks
9. Drive Axle, Wheels / Tires

The truck shown above is a typical representation of a CLARK internal combustion lift truck. Your model may vary slightly.

Operator Compartment

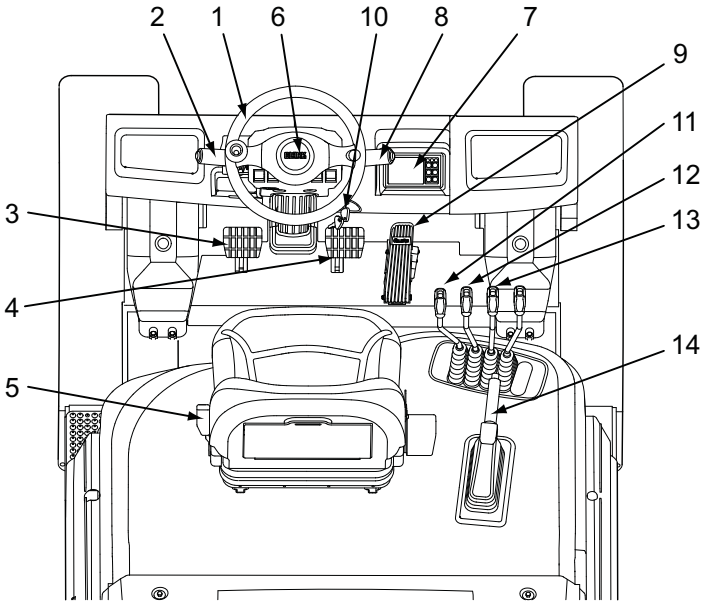

- | | |
|--------------------------|-----------------------------|
| 1. Steering Handwheel | 8. Turn Signal Lever |
| 2. Forward/Reverse Lever | 9. Accelerator Pedal |
| 3. Inching Pedal | 10. Key Switch |
| 4. Brake Pedal | 11. Lift Control Lever |
| 5. Seat Adjustment Lever | 12. Tilt Control Lever |
| 6. Horn Button | 13. Auxiliary Control Lever |
| 7. Instrument Pod | 14. Parking Brake Lever |

Instrument Pod

(C40-80)

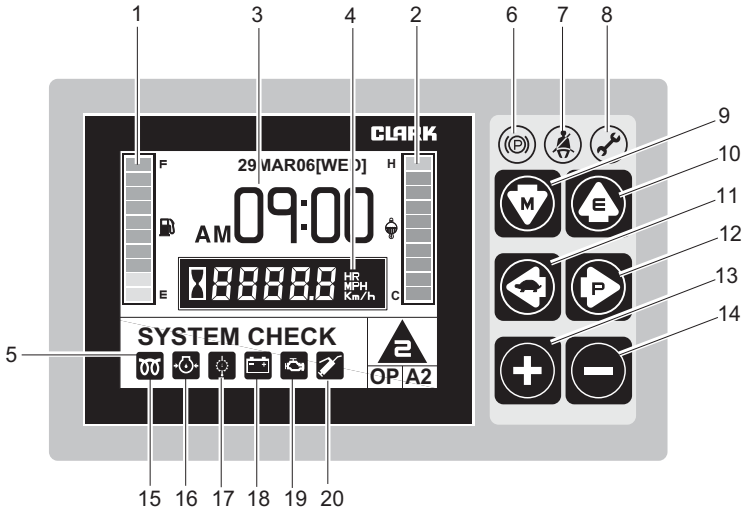

- | | |
|--|---------------------------------------|
| 1. Fuel level Indication | 11. Left arrow button |
| 2. Engine coolant temperature indicator | 12. Right arrow button (Power button) |
| 3. Date & Time display | 13. Plus button |
| 4. Hourmeter & Speed | 14. Minus button |
| 5. Message display & Travel direction icon | 15. Glow Plug Preheat |
| 6. Parking brake LED | 16. Engine Oil Pressure |
| 7. Seat belt LED | 17. Transmission Oil Temperature |
| 8. Error LED | 18. Alternator Charging Status |
| 9. Down arrow button (Mode button) | 19. Engine check |
| 10. Up arrow button (Enter button) | 20. Service Icon |

Pod Symbols and Functions

Functions

1. General function

The instrument pod consists of indicator lights, an hour meter, a circuit board and attached gauges. The pod provides the operator with important information about truck conditions and can shut down the truck in the event that certain critical conditions are present.

2. Engine shutdown function

The instrument pod circuit board receives signals from sensors in various locations and shuts down the truck when Transmission fluid temperature is excessive or engine oil pressure is low. Before shutting down the truck, the instrument pod sounds alarm for 20-30 seconds and flashes indicator lights. After shutdown, the truck may be restarted, but if the fault condition persists, the truck will shut down again.

3. Neutral start function and Anti-restart function

Neutral start function

The instrument pod will not allow the starter to be engaged if directional switches are closed or key has been in start position once. Key switch must always be turned OFF to restart engine.

Anti-restart function

When engine is already running, the start motor does not rotate although the key switch is turned to the start position.

IMPORTANT

For safety reasons, every CLARK forklift truck is fitted with a neutral start switch. The purpose of this is to prevent the engine from being started while the transmission is in gear. Thus the engine may only start when the direction control lever is in the neutral position.

4. Anti-drive and parking brake reminder function

When parking brake is engaged, the truck cannot be driven even when the directional switch is closed. A parking brake alarm shall be activated if key switch is turned to the OFF position and the parking brake is not applied. Applying the park brake will reset the alarm.

5. Gauges and indicators

- **Coolant temperature gauge**

It is divided into 2 colour zones according to temperature. If the wire of cooling water temp gauge is broken or the gauge scale doesn't move after 10min of engine starting, engine will be shut down because the gauge is recognized as defective.



- **Fuel gauge**

It displays the remaining fuel level in fuel tank. If the level is low, the Flashing and buzzer will sound 1 Second and "LOW FUEL" message will be displayed on LCD window.



- **Transmission oil temperature**

Indicates that the Transmission oil temperature is excessive. If the light is on, shut down the truck and service it. The truck will go into shut down mode after the light flashes for 30 seconds. (the buzzer sounds)

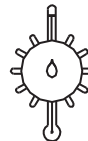

- **Engine oil pressure**

Indicates engine oil pressure is too low. If the light is on, shut down the truck and service it. The truck will go into shut down mode after the light flashes for 30 seconds.(the buzzer sounds)



If during operation, while engine is running, oil pressure switch closes to ground, the buzzer will sound immediately.

After 5 seconds, the engine will shutdown. The function that has caused the shutdown will flash the corresponding icon until the key is returned to the off position.

- **Engine check**

When the engine has problem, this LED will be on.



- **Alternator charging status**

Indicates that the alternator is not properly charging the battery. Service is required to correct the problem.



- **Service icon**

LED will illuminate when pre-set service time is reached. When LED is on, the pre-set service time has been reached indicating that a PM is required. Refer to Service Manual for proper PM procedures.



Pre-set service time setting method - initialized by "key on + FWD + F1 + F2", service time display at hour meter. Here, F1 is for up set, F2 is for down set (with interval times of 50 hours). When the key switch is turned OFF, the pre-set service time setting time is saved. Pre-set service time counts down opposite to operating time. To disable the Service Icon, set the pre-set service time to "-1000" (display 1 0 0 0); If you push the F2 switch when setting the pre-set service time, the time will be adjusted to "-1000".

- **Turn signal**

Indicates that the turn signal switch is actuated.



- **Glow plug Preheat (Diesel truck)**

Indicates glow plugs are in the process of preheating the diesel engine. When the ignition switch is turned to the "ON" position, a timer is set. This symbol displays until the timer cycle is completed. The engine may then be started.



- **Seat belt**

At start-up, this light and a buzzer come on for three seconds to remind the operator to fasten the seat belt. There is no start interlock.



IMPORTANT

You should always have your seat belt securely fastened when operating your lift truck.

- **Parking brake**

Indicates that the parking brake is engaged. Anytime the parking brake is on, the truck can't be driven because the Transmission solenoid valves switch is off. When the parking brake is not set and the key switch is turned to the OFF position, the instrument pod will sound.



If the parking brake is set, buzzer and horn will not sound.

- **Date & Time**

It displays current date and time.



- **Hourmeter & Speed**

It displays the accumulated operating hour and traveling speed of truck.

When the traveling speed is less than 0.5km/h, it displays the accumulated operating hour.

When the traveling speed is more than 0.5km/h, it displays the traveling speed.

It can be displayed in the of km/h or MPH.

Hour Meter

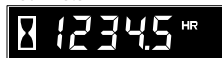

Speed Meter



• **Message display**

The model name, POWER selection, travel direction, warning and error message are displayed.

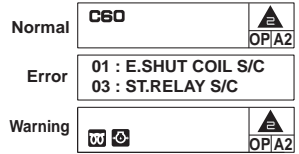

In normal operating condition:
Model name/Travel direction

When several messages are simultaneously displayed, it will be displayed in the order of Error, Warning and Normal condition.

If many error conditions are simultaneously occurred, the priority 2 Errors will be displayed.
(The priority means Error number)

When failure and warning are caused at the same time, the content of failure will be displayed on top row and the warning icon at below row.

• **Travel direction icon**

Function: To display the traveling direction or gear selected condition of truck.

Receive the traveling direction data from the T/M controller.

When it is in neutral, the arrow and gear icon will not be displayed.

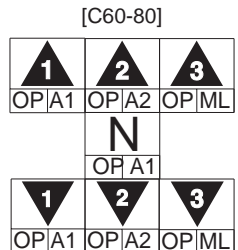
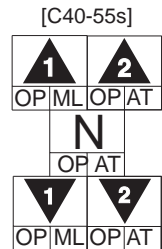

- **Error icon**

When error occurs this icon is displayed to distinguish the condition easily. When the error message is displayed, this icon is simultaneously displayed.



- **MODE SELECTION BUTTON**

6 mode selection buttons are located on right side of LCD..

Each button has specific function, and some have multiple functions.



- **Down arrow button (Mode button)**

Pressing this button in normal operating condition, it will move to Menu mode.

Pressing it in Menu mode, it will move to lower menu.

Pressing it in the lowest mode, there will be no change.



- **Up arrow button (Enter button)**

Pressing this button, it will move to upper menu.

It will also take role of "Enter" button when confirming the changed password or main parameters.



- **Left arrow button**

Pressing this button, it will move to left menu.



- **Right arrow button**

Pressing this button, it will move to right menu.



- **Plus (+) button**

1. Increase the data as set value in the current Menu mode.
2. It performs DR/OP selection function at normal mode



It selects DR → OP in turns, whenever pressing the button. The data for the selected mode will be transferred to T/M controller. Under S/L mode, DR/OP does not change.

NOTICE

Only operate the truck in operating (OP) mode. DO NOT operate the truck in diagnostic (DR) mode. Diagnostic mode is intended for service technicians only and may result in unintended transmission alarms to be displayed.

- **Minus (-) button**

1. Decrease the data as set value in the current Menu mode.
2. It performs ML/A1/A2 selection function at normal mode.



It selects ML → A1 → A2 in turns, whenever pressing the button. The data for the selected mode will be transferred to T/M controller. Under S/L mode, ML/A1/A2 does not change.

IMPORTANT

CLARK recommends to operate the truck in automatic (A1 or A2) mode to prevent excessive wear to the transmission. If operating in manual (ML) mode, always begin travel in 1st or 2nd gear. Do not operate the truck in ML mode without selecting the correct gear.







Urea(SCR) System (C60-80D, Doosan Engine)

This SCR(Selective Catalytic Reduction) urea solution system for reduces emission by utilizing urea solution in order to convert nitrogen oxide(Nox) remaining in emission into nitrogen and water. Modification of a forklift affect the performance, safety and life of the modified forklift and is considered as an act of violation of regulations and laws regarding emission. Please note that CLARK will not take any liability for an performance issue and/or damages of a forklift derived from the modification of a forklift.

Urea solution gauge

The urea gauge shows the current level of urea solution in the tank.

Check the remaining level regularly and refill as needed.

Level(ON)	Color	Amount(%)
	Green	76 ~
	Green	51 ~ 75
	Green	26 ~ 50
	Green	11 ~ 25
	Yellow	6 ~ 10
	Red	0 ~ 5

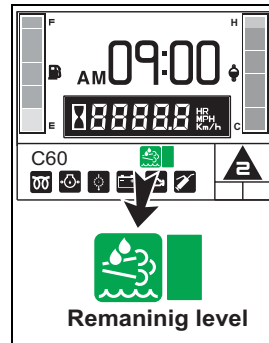

WARNING

The engine warning light will be ON and the output will be reduced if the forklift is operated without sufficient urea solution.

How to fill urea solution

1) By using urea solution injector(at a gas station)

- Make sure that the engine is OFF.
- Engage the parking brake and open the urea solution tank cover.
- Open the cap of the tank by turning it counterclockwise.
- Make sure that the urea solution meets the specifications of ISO 22241.
- Make sure that the urea solution does not overflow.

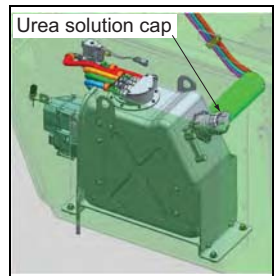

IMPORTANT

Make sure that there is NO foreign substance while filling the urea solution tank, including any additive and water. Such foreign substance will gravely affect the forklift performance and may cause a malfunction.

Make sure that the urea solution meets the specifications of ISO 22241. Urea solution of poor quality will gravely affect the forklift performance and may cause a malfunction.

- Turn the cap of the tank clockwise and close it completely. Wipe the area around the cap with a clean cloth after filling the tank. Any remaining urea solution will contaminate the forklift.

2) With a publicly available urea solution bottle

- Make sure that the engine is OFF.
- Engage the parking brake and open the urea solution tank cover.
- Open the cap of the tank by turning it counterclockwise.
- Make sure that the urea solution meets the specifications of ISO 22241.
- Make sure that the urea solution does not overflow.



IMPORTANT

Do not add urea solution if the tank is full(recommended amount is 20 L). Overfilling the tank may cause frosting in winter and the urea solution will expand and damage the tank as well as the SCR system.

Make sure that there is NO foreign substance while filling the urea solution tank, including any additive and water. Such foreign substance will gravely affect the forklift performance and may cause a malfunction.

Make sure that the urea solution meets the specifications of ISO 22241. Urea solution of poor quality will gravely affect the forklift performance and may cause a malfunction.

- Turn the cap of the tank clockwise and close it completely. Wipe the area around the cap with a clean cloth after filling the tank. Any remaining urea solution will contaminate the forklift. (Consumption of urea solution may vary per driving practices and conditions.)

How to store urea solution

1. Make sure NOT to use the container of the following materials to store urea solution. → Aluminum, Copper, Copper alloy, Non alloy metal, Zinc coated metal(Galvanized steel)
Storage of urea solution shall comply with the following.
2. The container to store urea solution must be made of the following materials only. → CR-Ni or Mo-Cr-Ni steel meeting the specifications of DIN EN 10088-1/2/3, Polypropylene, Polyethylene.
3. It is recommended that urea solution be stored indoors rather than outdoors to prevent frosting, in a completely closed container. Do not use remaining urea solution in the bottle unless it has been completely closed.

Purity

1. The following cases will gravely affect or damage the emission purification system:
 - Adding any detergent or liquid other than urea solution in the tank
 - Adding any additive to urea solution
 - Diluting urea solution with water

IMPORTANT

Make sure that the urea solution meets the specifications of ISO 22241 or DIN 70070.

2. Any foreign substance in the tank may cause the following issue:
 - Malfunction of the catalyst and emission purification system
 - Damage of the engine

IMPORTANT

Do NOT use the urea solution taken out of the tank for reasons such as servicing the forklift as it may not have the required purity - Use the new bottle only.

Cautions for using urea solution



WARNING

1. Make sure **NOT** to come into contact with the water from the exhaust. The water from the catalyzing effect is mildly acidic and may damage the skin. Rinse off immediately if you come into contact with the water
2. The emission reduction system causes high heat, thus make sure to work on the system after its surface is completely cooled down. Otherwise you may suffer a burn on the skin.



WARNING

1. Make sure to use the urea solution of the designated specifications for the forklift with the SCR system.
2. Adding urea solution of poor quality or any liquid not recommended herein may damage the forklift components such as the emission reduction system. Also the foreign substance in the unverified additive may block the flow of the SCR catalyst and damage the system.
3. Rinse off the urea solution with clean water if it contacts the eye.
4. Rinse your mouth with clean water and drink a lot of water if you consumed any urea solution. Also seek medical help immediately.
5. Immediately change into new clothes if the current ones are stained with urea solution.



6. Make sure that NO children or the old and the handi-capped use the urea solution.
7. The surface where urea solution is leaked must be rinsed with water, or be washed with cold water and a clean cloth. If crystallization already occurred with the leaked urea solution, use a clean sponge or cloth to clear the area. Urea solution gets crystalized into white crystals in some time and contaminates the surface.
8. Urea solution is not a fuel additive and shall NEVER be added to the fuel tank. Adding urea solution to the fuel tank may damage the engine.
9. The urea solution is the colorless and odorless soluble liquid with no flammability and toxicity.
10. Make sure the forklift is parked at a well-ventilated place when filling the urea solution tank. The urea solution may get chemically dissolved if heated up to 50°C for extended time. The dissolution will generate ammonia vapor.
11. Opening the urea solution tank cap in hot weather may cause the ammonia vapor to leak from the tank. The ammonia vapor has highly irritable odor and irritate skin, mucous membrane and eyes. You may suffer irritation in the eye, nose and neck, with some coughing and tears. Do NOT inhale the leaked ammonia vapor.
12. Make sure that the room where you handle the urea solution is well-ventilated. A pungent gas may come from the urea solution tank when it is opened.
13. Use caution that urea solution overflows when filling the tank with the bottle of urea solution. Check the tank gauge on the side while filling the tank.
(Recommended amount is 20 L)

Indicator for errors affecting emissions

The indicator will be activated if there is any issue with related systems or if urea solution is insufficient.

Make sure to check the error check on the dashboard.



Resetting post-processing device

The post-processing device needs to be periodically reset in order to maintain its efficiency of purifying emissions at reasonable levels.

The following icon will be displayed if the device needs to be reset.

1) Indicator for resetting post-processing device

When the indicator for resetting post-processing device on the dashboard is ON while the forklift is in operation, the forklift automatically engages resetting the devices. This is “automatic reset”.



Keep the following in mind when the automatic reset is engaged.

- Do NOT turn off the forklift during the automatic reset.
- A task of high load is preferred for efficiency of the reset.
- The icon will turn off when the automatic reset is complete.



WARNING

There may be some odor similar to that of burning sulfur in the middle of the reset. Make sure to run the reset in the well-ventilated outdoor environment. Move the forklift to a safe place if any flammable gas or particle is generated from it. Warn anyone nearby not to come close to the forklift or contact the exhaust system as the emission from the engine is hot.

NOTICE

If the “forced reset” may be necessary after stopping the forklift when the reset fails due to low temperature of the emission, thus it is recommended to start the reset while the engine is running and the current task is engaged as much as possible for successful automatic reset.

2) Indicator for forced reset

The forklift will turn on the indicator for forced reset on the dashboard if it is operated in low load for a long time or if the reset blocking button is engaged.

The reset has to be started if the icon flashes, which is called "forced reset".



CAUTION

When the "forced reset" indicator is on, the operator must engage the forced reset in 10 hours.

Otherwise, the engine output may be reduced.

The engine output will be reset after the forced reset.

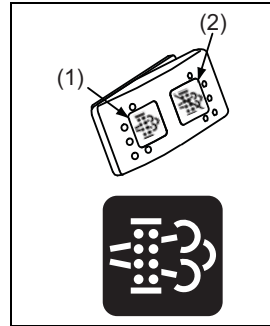

Run the forced reset in the following sequence:

1. Move the forklift to an appropriate place.
2. Set the gear at neutral without turning off the engine and engage the parking brake.
3. Push and hold the forced reset switch on the right side of the dashboard in the direction of (1) for more than 3 seconds. Take the hand off and the switch will return to the original place.



CAUTION

Holding the forced reset switch for too long (more than 30 seconds) will fail the engine.

4. The alarm indicator on the right side of the dashboard will also be lit when the force reset starts.

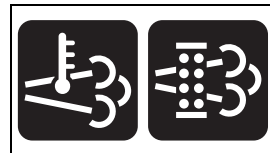

CAUTION

Make sure NOT to turn off the engine during the reset and run it in idle mode. Do NOT press the pedal during the reset. The engine coolant shall be kept hotter than 40°C.

5. The forced reset generally takes 15~20 minutes.
(up to 25 minutes)

⚠ CAUTION

The reset may fail unless any of the above items of 1~5 is met.

⚠ WARNING

There may be some odor similar to that of burning sulfur in the middle of the reset. Make sure to run the reset in the well-ventilated outdoor environment. Move the forklift to a safe place if any flammable gas or particle is generated from it. Warn anyone nearby not to come close to the forklift, especially from behind, or contact the exhaust system as the emission from the engine is hot.

3) Indicator for reset blocking

Pressing the reset blocking switch (2) for blocking or stopping the reset during automatic reset of the post-processing device will turn on the indicator for reset blocking and the reset will be blocked.

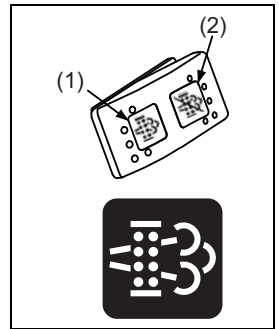

IMPORTANT

Engage the switch to block the resetting operation in an indoor environment or the reset needs to be stopped.

⚠ CAUTION

The reset will be kept blocked unless the reset blocking switch is released manually.

Press the switch (1) to release the blocking function and return the switch back.

Operator Controls

Key/Start Switch

The Key/Start Switch:

- Turns the truck electrical system on and off.
- Connects and tests the warning indicator lights.
- Connects the starter motor circuit when engine is to be started.

The Key/Start Switch has three positions.

When the key is in the vertical "OFF" position, all truck electrical circuits are off, and the key can be removed. From the "OFF" position, the key can be turned clockwise to the "START" position, where the starter motor is engaged and part of the truck electrical system is energized. When the key is released from the "START" position, it automatically returns to the "ON" position, where the starter is disengaged and the entire truck electrical system is on.

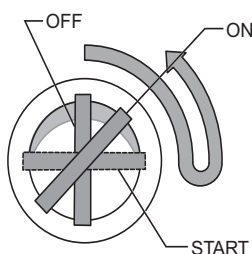

The key switch has a mechanical "anti-restart" feature, which prevents the engine starter from being engaged and damaged if the operator attempts to start the engine when it is already running. The key switch cannot be turned to the "START" position from the "ON" position without returning the key to the "OFF" position. If the engine stops running, the key switch must be turned to the "OFF" position before it can be restarted.



CAUTION

Turn the key to START position one or two seconds after being turned to the ON position to start the C40-80D trucks mounted with DEUTZ engine.

Cold Start Preheating (Diesel Only)

With the switch in the "ON" position the warning indicator will light up then the glow plugs are pre-heating automatically. The engine can then be started. To repeat the preheating process turn the key to the "OFF" and then into the "ON" position.

Engine Stop

Run the engine at idling speed briefly before shutting it off. Turn the key switch to the "OFF" position to shut the engine down.

Seat Adjustment

The fore and aft adjustment lever is located on the front under the seat. To unlock, pull the lever to the left and adjust the seat, release the lever. Be sure that the seat locking mechanism is engaged. The back declining adjustment lever is located on the left side of seat cushion. Pull the lever up and adjust the back, release the lever. Be sure that the back locking mechanism is engaged.

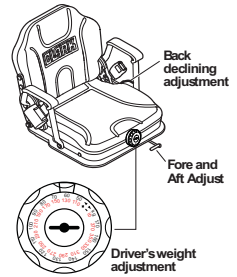

CAUTION

Never adjust driver's seat while truck is moving, to avoid the possibility of loss of control and of personal injury.

Parking Brake

Activates brake operation.

Check the parking Brake

The brake is applied by pulling the lever up. It is released by pushing down.

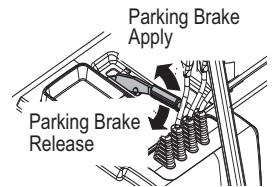

CAUTION

Always apply parking brake before leaving truck.



WARNING

Never operate your lift truck with a defective parking brake.

Hour Meter

Starting the engine also starts the operating hour meter. Use the hour meter reading to perform prescribed maintenance.



Steering System

The steering handwheel operates a steering control valve that directs the oil flow to the steering cylinder connected to the steer axle. The steering control valve can also act as a pump to provide manual steering if the hydraulic pump stops.

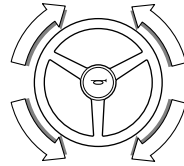

Horn Button

The horn button is located in the center hub of the steering handwheel. Depressing the button will sound the horn.

Brake Pedals

The left hand brake pedal (inching pedal) has two functions in order to improve handling and efficiency. While pressing the inching pedal the first part of its movement interrupts the power from the engine to the transmission. The level of disengagement is dependent on the movement of the pedal. The last part of the travel applies the brake.

This way you are able to lift a load rapidly, with full engine speed, while controlling slow driving speed with the inching pedal like a clutch. This is very useful in confined working spaces. On ramps or inclines, only the right hand brake pedal should be used. When using the inching pedal on slopes, the lift truck could move unintentionally.

Direction Control Lever

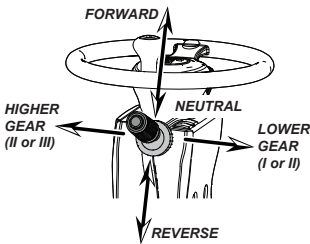

This lever is usually on the left side of the steering column. When changing direction, make sure that your truck has come to a complete stop before changing the lever's position. This lever also allows the operator to select the transmission gear if operating in manual (ML) mode.



CAUTION

If the truck starts with the direction control lever in forward or reverse, the neutral start switch is damaged or faulty and must be repaired.

Traction Disable Function

When driver leaves seat over 3sec, transmission goes to neutral (power to fwd/rev solenoids is shut off). When driver gets back in seat, truck must not go into gear until he shifts to neutral, then shifts into gear.

Hydraulic Control Levers

The levers of the control valve activate the lift and tilt cylinders as well as any other hydraulic devices which are installed on the truck.

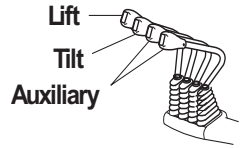

IMPORTANT

The hydraulic levers shown are typical representations of a CLARK internal combustion lift truck. Your model may vary slightly.

Lift Control Function

With the lift control lever, you are able to raise and lower the fork carriage on the upright. The lifting and lowering speeds are controlled through the main hydraulic valve by varying the lever position (from the center or neutral positions).

When the lift control lever is pushed forward, the fork carriage is lowered. When the lift control lever is pulled back the fork carriage is raised. You can also lower the fork carriage even if the key switch is OFF.

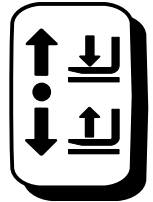

Tilt Control Lever

With the tilt control lever, you are able to control the tilting or vertical positioning of the upright and the angle of the forks. When the lever is pulled back, the upright and forks tilt backward. Push the lever forward to tilt the upright and forks forwards.

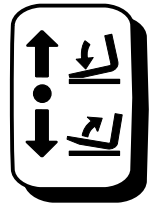

Auxiliary Control Lever (Optional)

An auxiliary control lever is mounted to the right of the tilt control lever. If your lift truck is equipped with an optional attachment, this lever lets you control the flow and direction of the hydraulic oil to the attachment.



Steering Column Pylon

The steering wheel can be tilted forwards and backwards in small discrete movements. Push and hold pylon lock, move the wheel to the desired position and release lock.

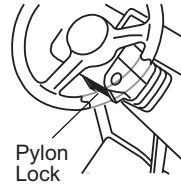

Hood open

The hood release lever is located on the left side of hood. (C45-55s)

Pull the lever to release the catch.

Hood release lever (C40-55s)

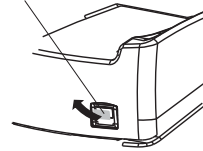

Unitrol Pedal(Optional)

With the CLARK Unitrol, the directional control lever is no longer located on the steering pylon. The direction of travel and speed of truck is determined by the Unitrol pedal.

- **Forward** : To select and move the truck in the forward direction you must push down on the(FWD arrow) left side of the Unitrol pedal. The further the pedal is depressed the faster the lift truck will go in forward.
- **Reverse** : To select and move the truck in the reverse direction you must push down on the(REV arrow) right side of the Unitrol pedal. The further the pedal is depressed the faster the lift truck will go in reverse.
- **Neutral** : The unitrol pedal activates only FWD and REV. Neutral is activated only when the parking brake is set.

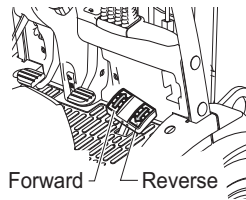

IMPORTANT

For safety reasons, your CLARK forklift truck is fitted with a neutral start switch. The purpose of this is to prevent the engine from being started while the transmission is in gear. Thus the engine may only start when the direction control lever is in the neutral position.



CAUTION

If the truck will start with the direction control in either forward or reverse, there is a problem with the neutral start switch and it must be repaired.

Truck Data and Capacity Plate

1. Truck model number or registered name.
2. Truck serial number -An identification number assigned to this particular truck and should be used when requesting information or ordering service parts for this truck from your authorized CLARK dealer.

CLARK From the factory this truck meets ASME B56.1

Model	Type	Serial No.
Attachments		
Rearward Tilt deg	A	D
-Capacities are with attachment		
-For loads with offset or		
-vertical position.		
-Capacities are for centered		
-or shifted loads, as		
-indicated by arrow.		
D/Tire Width	in	mm
D/Tire Type	B	mm
Truck Weight	lb or kg	Max Battery lb or kg
Electric Truck	Min Battery	lb or kg
Max. Amp Hrs.	Volts	Battery Type

For other capacities contact Clark Material Handling Co., Lexington, KY 40525

- The serial number is also stamped on the frame.
3. Attachment description (if any installed) - The user must see that the truck is marked to identify the attachment(s), including the weight of the truck/attachment combination and truck capacity with the attachment.
 4. Capacity rating, load center, and lifting height data - Shows the maximum load capacity of this truck with relation to load centers and fork heights (see diagram on plate). Personal injury and damage to the truck can occur if these capacities are exceeded. **Do not exceed the maximum capacity specified.**
 5. Truck weight - The weight of the truck without a load on the forks. This weight plus the weight of the load must be considered when operating on elevators, elevated floors, etc. to be sure they are safe.



CAUTION

When attachments are added or if the truck is modified, the capacity of the truck may be affected. Contact your authorized CLARK dealer for a new nameplate showing the revised capacity.

IMPORTANT

OSHA requires prior written approval from the manufacturer before any modifications affecting capacity or safety may be made.

Operator Safety Warning Decal

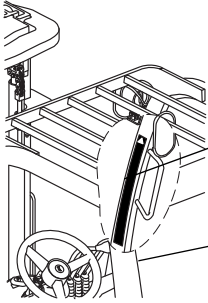

IMPORTANT

Safety and warning decals are placed in conspicuous locations on the truck to remind you of essential procedures or to prevent you from making an error that could damage the truck or possibly cause personal injury. You should know, understand, and follow these instructions. Safety and warning decals should be replaced immediately if missing or defaced (damage or illegible).

Operator/Tip-Over

This decal is located on the front right hand leg of the driver's overhead guard. It is to remind the operator that staying in the seat provides the best chance of avoiding injury in the event of a tip-over or off the dock mishap.

Lift trucks can be tipped over if operated improperly. Analysis of lift truck accidents has shown that the driver cannot react quickly enough to jump clear of the truck and overhead guard as the truck tips. To protect operators from severe injury or death in the event of a tip-over, it is best to be held securely in the seat. So, please, always buckle up when driving your lift truck.

WARNING
Read the manual
Buckle up!
Apply brake when leaving truck

Watch Out For Other People
Most lift truck INJURIES are to other people near the lift truck.

Prevent Overturns!
AVOID :
• slippery, sloping, or uneven surfaces
• loads over capacity on nameplate
• unstable or high loads
• low tire pressure
• poorly maintained lift truck
• fast or sharp turns

In Case of Tip-Over:
Don't jump
Hold on tight
Brace feet
Lean away



Upright Warning Decal

This safety decal is on the upright to warn of the danger of injury from movement between rails, chains, sheaves, fork carriage, and other parts of the upright assembly. Do not climb on or reach into the upright. Personal injury will result if any part of your body is put between moving parts of the upright.

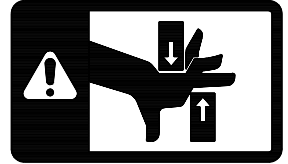

Keep Away from Forks Decal

This safety decal is placed on the upright to warn of the danger of injury from forks when they are in the raised position. Do not ride on or stand under forks or attachments. The forks can fall and cause injury or death. Always make sure that the forks are in the fully lowered position when they are not being used to handle a load.



Hot Surface Warning Decal

The warning decals are attached to the engine, the tail pipe when vertical exhaust system is installed, and on the heater when cabin is installed.

The surface of decal is very hot by the heat generated during work.

If this surface is touched, serious burns may result.



Attached position of safety decals



Caution

Do not operate a lift truck with damaged or missing decals or data plates. Replace them immediately. They contain important information. Contact your local CLARK dealer to acquire new decals or data plates.

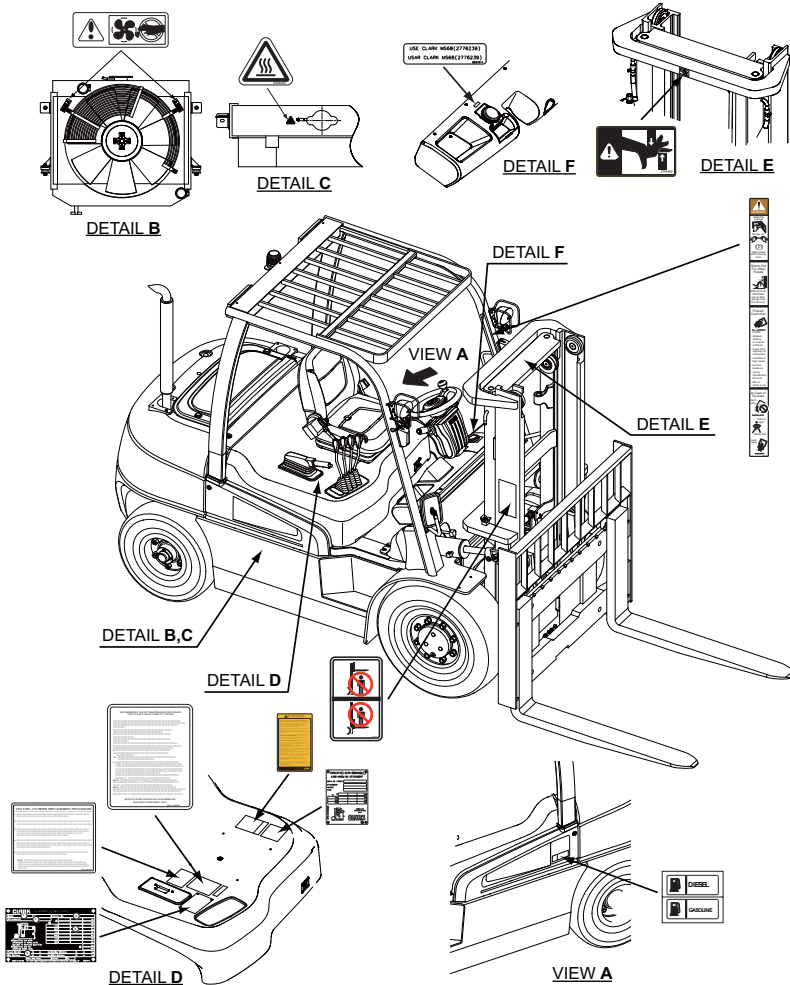

Operating Procedures

Contents

Before Operating the Truck	4-2
Starting from a Safe Condition	4-3



Before Operating the Truck

Be sure that you have read and understand the information in this Operator's Manual before operating the lift truck.

The Operator's Manual Holder is located on the back of the seat.

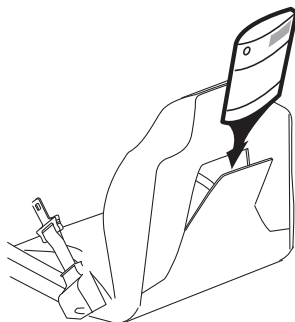

WARNING

- This equipment can be dangerous if not used properly. Safe operation is the responsibility of the operator.
- Do not start or operate the truck, or any of its functions or attachments, from any place other than the designated operator's position.

CAUTION

- Inspect your lift truck before operating at the start of the day or shift. Before putting your truck to use, check the operation of the controls and all systems.
- Protect yourself. Do not operate truck without a driver's overhead guard unless conditions prevent its use. Do not remove overhead guard unless specifically authorized. Use special care if operation without this safety device is required.

Starting from a Safe Condition

Always start from a safe condition. Before operating a lift truck, make sure that:

1. Parking brake is applied.
2. Forks are fully lowered to the floor or ground.
3. You are familiar with how all the controls function and have read the Operator Manual.
4. All controls are in neutral or other correct position.
5. Truck has received its daily inspection and is ready and safe to operate.

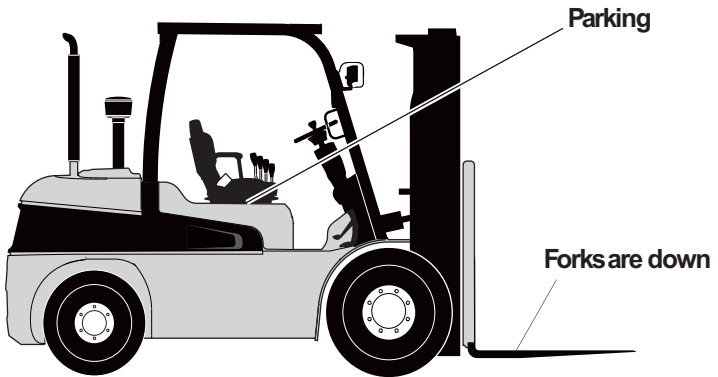

Put the direction control lever in the **NEUTRAL position**, before turning the key switch to ON.

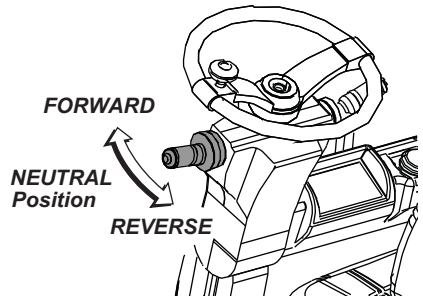

Adjusting the Seat

Adjust the seat to a comfortable position for you. Adjust the seat by moving and holding the release lever at the front under of the seat. Put the seat in a position that will provide easy reach to all controls. Release the seat lever. Make sure that the seat locking mechanism is engaged.

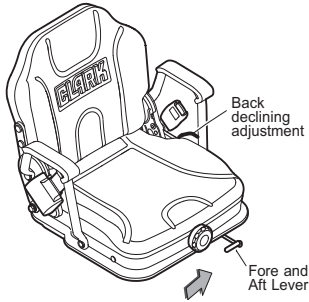

CAUTION

Never adjust the driver's seat while the truck is moving, to avoid the possibility of loss of control and of personal injury.

Buckling Up

Buckle up. Be sure that you put on the seat belt. Connect and adjust the seat belt strap to a snug, comfortable position.

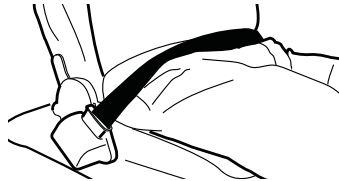
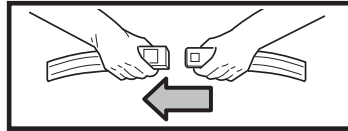

WARNING

Always wear your seat belt when operating a lift truck.

Starting the Truck

Before you start the truck, make sure that you have taken all the above mentioned precautions and that the directional control is in NEUTRAL. To start the truck, turn the key switch clockwise to the ON position.



Positioning Forks and Upright

When driving, with or without a load, it is good practice to have the forks slightly raised and tilt the upright (forks) backward. Having the forks raised and tilting back prevents the fork tips from catching on possible obstructions and reduces the wear on the fork blades from striking or dragging on the floor or ground. See the NOTICE and CAUTION below.

Pull back on the lift control lever and raise the forks 6 to 8 inches (152 to 203 mm) above the floor. Then, using the tilt control, tilt the upright back slightly to raise the fork tips.

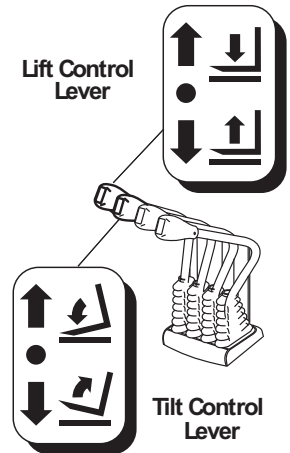

NOTICE

When the upright (carriage and/or load) is raised, the stability of the truck is reduced. Some of the other conditions that may affect stability are: ground and floor conditions, grade, speed, loading, dynamic and static forces and the judgement exercised by the operator. Trucks equipped with attachments behave as partially loaded trucks even when operated without a load on the attachment. Also, improper operation, faulty maintenance or poor house-keeping may contribute to a condition of instability.



CAUTION

For stability reasons, do not travel with the load or carriage raised into a high (elevated) position. Travel with the lift mechanism raised only enough to clear the ground or obstacles.



WARNING

If your truck starts to tip over, **DO NOT JUMP!** Your chances for survival in a tip-over are better if you stay with the truck, in your seat. **BRACE YOURSELF!** Make sure your seat belt is fastened securely. Stay in your seat. Grip the wheel. Brace your feet. See *page 1.14*

Controlling Speed

With the direction control in FORWARD or REVERSE, the parking brake released, put your foot on the accelerator pedal and push down smoothly until the truck is moving at the desired speed.

Braking

To stop the truck, lift your foot from the accelerator pedal and put it on the brake pedal. Push down on the brake pedal in a smooth, firm motion until the truck is stopped.

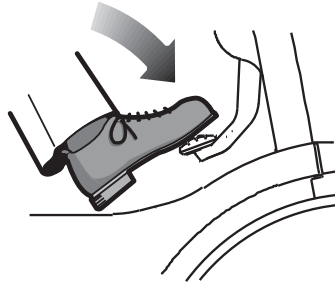

IMPORTANT

Stop a lift truck as gradually as practical. Hard braking and wheel sliding are dangerous and can cause tip-over or the truck could lose its load. Also, hard braking can increase wear and can be harmful to the lift truck.

Operating Safely

IMPORTANT

Safe operation is the responsibility of the operator. Watch where you are going. Don't go if you can't see.

Before driving, check all around to be sure that your intended path of travel is clear of obstructions and pedestrians.

While driving, be alert for pedestrians, other vehicles or obstructions in your path of travel.

Watch people. Do not allow anyone to stand or pass under the load or raised forks. Watch for people in your work area even if your truck has warning lights or alarms. They may not watch for you.

Sound horn at intersections and wherever vision is obstructed. Do not drive a truck up to anyone standing in front of an object.

Protect yourself and those around you...

Operate the truck only from the designated operator's position. Stay within the confines of the lift truck profile dimensions. Keep arms, legs and hands inside the operator's compartment and away from the danger of passing obstructions. Keep under the overhead guard.

NOTICE

An overhead guard is intended to offer protection to the operator from falling objects, but cannot protect against every possible impact. Therefore, it should not be considered a substitute for good judgement and care in loading, handling, storage, etc..

Keep clear of the upright and lift mechanism. NEVER reach into or put hands, arms, legs or head into or through the upright structure or near the carriage or lift chains. Never put any part of your body between the upright and the truck. Don't use the upright as a ladder.

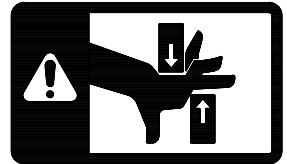

Keep all other persons clear of the load and upright mechanism while attempting to handle a load.

No riders...

Do not carry passengers. The operator is the only one who should be on the truck.

Always be in full control of your lift truck...

Never operate a lift truck or its attachments if you are not in the designated operator's position.

Never operate a lift truck when your hands are wet or greasy.

Always pick the smoothest travel route for your lift truck. Avoid bumps, holes, slick spots, and loose objects or debris in your path that may cause the truck to swerve or tip. If these conditions are unavoidable, slow down and carefully drive past them. Slow down for wet or slippery surfaces.

Avoid any sudden movement. Start, stop, travel, steer, and brake smoothly.

Operate your lift truck under all conditions at a speed that will permit it to be brought safely to a stop.



WARNING

Travel slowly when turning. Use special care when traveling without a load because the risk of tipping over is greater with an empty truck, especially at high speed and when cornering.

Travel with the fork carriage tilted back and raised only enough to fully clear the ground or obstacles. When the carriage (load) is elevated, the stability of the truck is reduced.

Do not elevate the load except during stacking.

Grades, ramps, and inclines...

Use special care when operating on ramps, inclines, and uneven areas. Travel slowly. Travel straight up and down. Do not turn or drive at an angle across an incline or ramp.

When the truck is loaded, travel with the load upgrade. When the truck is empty, travel with lifting mechanism (upright) downgrade.

Practice safe operation every time you use your truck...

Careful driving and operation is your responsibility. Be completely familiar with all the safe driving and load handling techniques in this operator's manual. Use common sense. Drive carefully; do not indulge in stunt driving or horseplay. Observe traffic rules. Watch for people and hazards. Slow down. Be in full control of your lift truck at all times.

Follow the instructions in this manual to avoid damage to your truck or the possibility of injury to yourself or others.

During your work, observe all functions of your lift truck. This allows you to immediately recognize a problem or irregularity that could affect the safe operation of your truck.

Periodically check the gauges and warning indicator lights in the instrument panel to be sure they indicate a normal condition. If an abnormal condition appears, shut off the key switch immediately and report the problem.

IMPORTANT

**Do not continue to operate a truck that has a malfunction.
Stop and have it fixed.**

IMPORTANT

**Always wear your seat belt
when operating your lift
truck.**

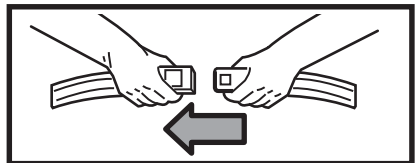

CAUTION

Operate your lift truck only in areas that have been approved for your lift truck type designation. Certain areas contain flammable gases, liquids, dust, fibers, or other hazardous materials. Lift truck operations in these areas must have special approval. These areas must be designated to show the type of lift truck approval required for operation in the area. Be aware that changes to special equipment or poor maintenance can cause the lift truck to lose its special approval. Be sure that your truck is the correct fire safety type for the area in which you are working. The proper type designation for this truck is listed on the nameplate. In areas classified as hazardous, use only trucks approved for use in those areas. If you are unsure of the classification of the area you wish to enter, check before entering.

Adjusting the Load Forks

The load forks are adjustable on the hanger shaft. Forks should be spaced as far apart as the load being carried will allow. Both forks should always be the same distance from the center of the fork carriage. To adjust the forks, raise the carriage slightly. Tilt the upright fully forward to reduce friction and make the forks slide easier. Unlock the fork locking pins. Position the forks. Secure the fork locking pins.

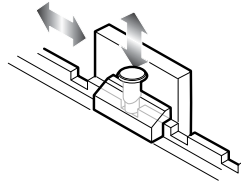

Forks are heavy, keep fingers clear. Move forks by pushing with one foot while holding on to the load back rest with hands. Be sure to have firm footing before attempting to move forks. Do not attempt this where the floor is slippery or wet.

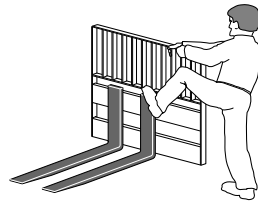

Load Handling

Handle only loads that are within the truck rated capacity as shown on the nameplate. This rating specifies the maximum load that should be lifted. However, other factors such as special load handling attachments, loads having a high center of gravity, or uneven terrain may dictate that the safe working load be less than the rated capacity. Under these conditions, the operator must reduce the load carried so that the lift truck remains stable.

Handle only stable or safely arranged loads. Do not handle loads made up of loose, unevenly stacked or unstable items that can easily shift and fall. Take the time to correctly stack and band loose items. Center the load on the forks.

Do not lift anything that might fall on the operator or a bystander.

Do not handle loads that are higher than the fork carriage unless the load is secured so that no part of it can fall backwards.

Keep the load back against the carriage. Loads placed out on the ends of the forks can make the lift truck less stable and more likely to tip up.

Lift and lower with the upright must vertical or tilted slightly back — **never tilted forward.**

Operate lift and tilt controls slowly and smoothly. Never tilt forward when carriage (load) is raised, except to pick up or deposit a load over a rack or stack.



WARNING

Slack chains mean rail or carriage hang-up. Raise the upright before you move. If the upright malfunctions in any way or becomes stuck in a raised position, operate the lift control to eliminate any slack chains. DO NOT go under a raised upright or forks to attempt repairs. DO NOT reach into or climb on upright to free hang-up.

Remember, your lift truck is designed to carry loads forward of the front wheels so that the weight of the load is counter-balanced by the weight of the truck.

The farther the load is carried from the pivot point (center of front wheels), the greater will be the uplift at the rear of the truck. Therefore, always carry the load as close to the front wheels as possible (back and flush against the face of the forks).

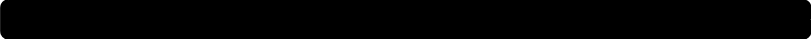

The capacity load shown on the nameplate is represented by a cube in which the weight is evenly distributed, with the center of gravity located a standard distance from the face of the forks. If the weight of the actual load to be handled is not evenly distributed, put the heaviest part closest to the carriage.

Traveling with a Load

Travel with load or carriage as low as possible and tilted back. Never travel with the load or carriage raised (elevated) in a high position. Do not elevate the load except during stacking.

Observe all traffic regulations and watch for other traffic, pedestrians, and safe clearances. Always look in the direction of travel. Keep a clear view of the path of travel, and when the load blocks your visibility, travel in reverse with load trailing (except when climbing an incline).

Avoid sudden movements when carrying a load—start, stop, travel, steer, and brake smoothly. Steer clear of bumps, holes, and loose materials or debris on the ground. Lift and tilt slowly and smoothly. Go slowly when turning. Cross railroad tracks slowly at an angle wherever possible.

Use special care when handling and traveling with long, high, or wide loads—to avoid losing the load, striking bystanders or obstructions, or tipping the truck.

Watch clearances around the truck and load as you travel. Raise the forks or attachment only to pick up or stack a load. Look out for obstructions, especially overhead.

Be aware that exaggerated tail swing, when turning while traveling forward, is a characteristic of lift trucks that are steered by the rear wheels. Accordingly, you need to become accustomed to tail swing and always check the tail swing area of the counterweight to be sure it is clear before you turn.

Always be concerned about the stability of your lift truck. When attachments are used, extra care should be taken in securing, manipulating, positioning, and transporting the load. Because attachments generally add extra weight and complexity to the truck, operate trucks equipped with attachments as partially-loaded trucks when not handling a load.

Picking Up and Moving Loads

When picking up a load from the ground, approach the load slowly and carefully align the truck square with the load. The forks should be adjusted to fit the load or pallet being handled and spread as wide as possible to provide good stability and balance. Before lifting, be sure the load is centered and the forks are fully under and supporting the load. Fork length should be at least $\frac{2}{3}$ of load length. With the lift and tilt controls, adjust the forks to the correct height and angle for freely engaging the load pallet. Move forward until the forks are squarely and completely under the load.

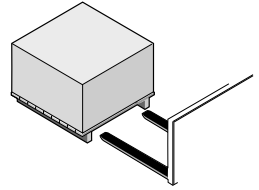

NOTICE

Be sure that the forks do not extend beyond the load, causing damage or tipping of other adjacent loads or materials behind the load being moved.

If the forks are longer than the load, move the tips partially under the load without extending beyond the load. Raise the load to clear the floor. Back out several inches, or whatever distance is necessary, then set the load down and move forward until the load is positioned against the carriage.

Raise the load from the floor or stack by tilting the upright back just enough to lift the load from the surface. When stacking or tiering, use only enough backward tilt to stabilize the load.

Then raise the load to traveling height and tilt fully back to travel (except for loads that must be transported as level as possible).

Unloading

To deposit a load on the floor after being moved into the correct position, tilt the upright forward to a vertical position and lower the load.

Adjust the fork height and tilt the upright forward slightly, as necessary, for smooth removal of the forks from the load (pallet).

Carefully back away to clear the forks from the load.

Raise the forks to traveling height and tilt fully back.

Stacking

To put a load on a stack:

1. Approach slowly and align the lift truck and load squarely with the stack.

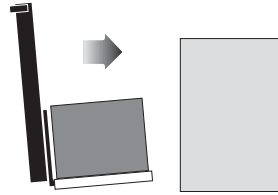

2. Raise (elevate) the load as the lift truck is nearing the stack.

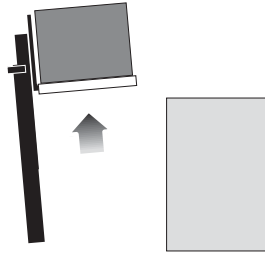

3. Move forward, slowly, until the load is almost touching the stack. The leading edge and sides of the load pallet should be lined up exactly with the near edge and side of the load or rack on which you are stacking.

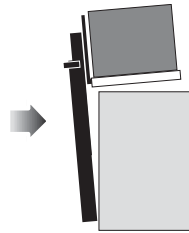

4. Stop close to the stack and further lift (raise) the load high enough to clear the top surface of the stack. Slowly move the load into position. Be careful not to damage or move adjacent loads.

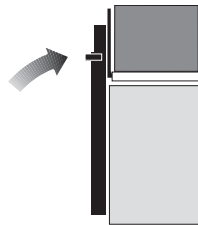

5. When the load is aligned with the stack beneath it, tilt the upright to the vertical position and carefully lower the load onto the top surface of the stack.

- Lower (drop) the forks slightly to clear (disengage) the load pallet. Tilt the forks forward slightly, if necessary.

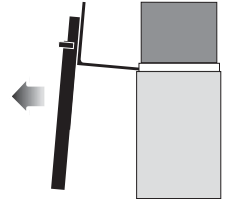

- Check your travel path, then carefully back away until the forks are clear of the stack. Stop and lower the forks to the travel position (6 to 8 inches above the ground), then tilt back to travel.

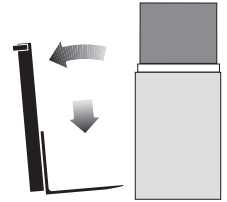

To move a load from a stack:

Approach the stack carefully, truck lined up squarely with the load. With the truck just in front of the stack and the upright must vertical, raise the forks to the correct height for freely engaging the load pallet. Adjust fork angle as necessary to fit squarely under the load. Move forward until the forks are under the load.

Be sure that the forks do not extend beyond the load, causing damage or tipping of other adjacent loads or materials behind the load being moved. If the forks are longer than the load, move the tips partially under the load without extending beyond the load. Raise the load to clear the undersurface. Back out several inches, then set the load down and move forward until the front face of the forks contacts the load.

Raise the load from the stack by tilting the upright back just enough to lift the load from the surface. Or, with the mast still vertical, raise the forks until they begin to lift the load. At this point, apply the minimum back tilt that will stabilize the load.

Check your travel path, slowly back off until clear of the stack, stop, and then lower the load to the travel position (6 to 8 inches off the ground). Tilt full back to travel (except for certain loads that may have to be transported as level as possible). Be sure the load is back flush against the carriage or front face of the forks.

NOTICE

Certain loads may have to be transported as level as possible.

After Operating the Truck

Always leave your lift truck in a safe condition. When you leave your truck, or park it, follow these safety rules:

- Park in a safe area away from normal traffic.
- Never park on a grade.
- Never park in areas that block emergency routes or equipment, access to fire aisles, or stairways and fire equipment.



Before leaving the operator's position:

1. Bring truck to complete stop.
2. Put the directional control lever in the NEUTRAL position.
3. Apply the parking brake.
4. Lower the lift mechanism fully.
5. Turn the key switch to the OFF position.

If you are going to leave the truck unattended:

6. Remove the key.
7. Block the wheels if the truck has any possibility of moving.

Operator Maintenance and Care

Contents

Daily Safety Inspection	5-2
Fuel Safety Practices	5-5
Refueling LPG Tanks	5-6

NOTICE

The Occupational Safety and Health Act (OSHA) requires that truck users examine their trucks before each shift to be sure they are in safe working order. Defects when found shall be immediately reported and corrected. The truck shall be taken out of service until it has been restored to safe operating condition.



Daily Safety Inspection

Before using a lift truck, **it is the operator's responsibility** to check its condition and be sure it is safe to operate.

Check for damage and maintenance problems; have repairs made before you operate the truck. Unusual noises or problems must be reported immediately to your supervisor or other designated authority.

Do not make repairs yourself unless you are trained in lift truck repair procedures and authorized by your employer. Have a qualified mechanic make repairs using genuine CLARK or CLARK-approved parts.



CAUTION

Do not operate a truck if it is in need of repair. If it is in an unsafe condition, remove the key and report the condition to the proper authority. If the truck becomes unsafe in any way while you are operating it, stop operating the truck, report the problem immediately, and have it corrected.

Lift trucks should be inspected every eight hours, or at the start of each shift. In general, the daily inspection should include the **visual** and **functional checks** described on the following pages.

As an aid in carrying out this inspection, CLARK has prepared a form called the **"Driver's Daily Checklist."** We recommend that you use this form to make a daily record of your inspections and truck condition. You may obtain copies of this form from your CLARK dealer.



WARNING

Leaking hydraulic oil may be hot or under pressure. When inspecting a lift truck, wear safety glasses and do not check for leaks with bare hands.

Visual Checks

First, perform a visual inspection of the truck and its major components:

1. Walk around your lift truck and take note of obvious damage that may have been caused by operation during the last shift.
2. Check that all capacity, safety, and warning plates or decals are attached and legible.
3. Check before and after starting engine for leaking fuel, engine coolant, transmission fluid, etc.
4. Check for hydraulic oil leaks and loose fittings.



CAUTION

Do not use bare hands to check. Oil may be hot or under pressure.

5. Be sure that the driver's overhead guard, load back rest and all other safety devices are in place, securely fastened and undamaged. Inspect for damaged or missing parts, corrosion, cracks, breaks etc.
6. Check all of the critical components that handle or carry the load.
7. Look the upright and lift chains over. Check for obvious wear and maintenance problems such as damaged or missing parts, leaks, slack or broken chains, rust, corrosion, bent parts, cracks, etc.
8. Carefully inspect the load forks for cracks, breaks, bending, twists, and wear. Be sure that the forks are correctly installed and locked in their proper position.
9. Inspect the wheels and tires for safe mounting, wear condition, and air pressure.
10. Check the hydraulic sump oil level, engine oil level, and fuel level.

Functional Checks

Check the operation of the truck as follows.

NOTICE

Before performing these checks, familiarize yourself with the starting, operating, and shutdown procedures in Section 4 of this manual. Also, know the safety rules given in Section 1 of this manual.

1. Test warning devices, horn, lights, and other safety equipment and accessories.
2. Start the engine and be sure all controls and systems operate freely and return to neutral properly. Check the:
 - Gauges, meters, and indicator lights
 - Service brakes, inching pedal, and parking brakes
 - Hydraulic controls: lift, tilt, and auxiliary (if installed)
 - Accelerator
 - Directional control
 - Steering system
 - Lift mechanism and any attachments.

When the functional checks are completed, follow the **standard shut-down procedures** given in Section 4, "Operating Procedures."

Concluding the Inspection

Make a record on the "Driver's Daily Checklist" of all the problems that you find. Review the checklist to be sure it has been completed and turn it in to the person responsible for lift truck maintenance. Be sure any unusual noises or problems are investigated immediately.

Do not operate a lift truck that has a maintenance problem or is not safe to operate.

Instead, remove the key from the ignition switch and put an "Out of Service" tag on the truck.

If all of the Daily Inspection checks were normal or satisfactory, the truck can be operated.

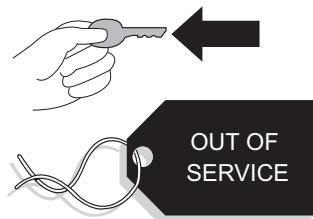

Fuel Safety Practices

Refueling Gasoline and Diesel Trucks

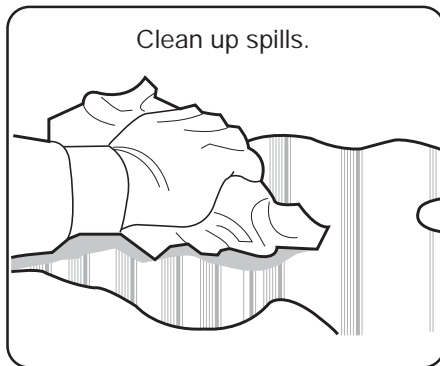
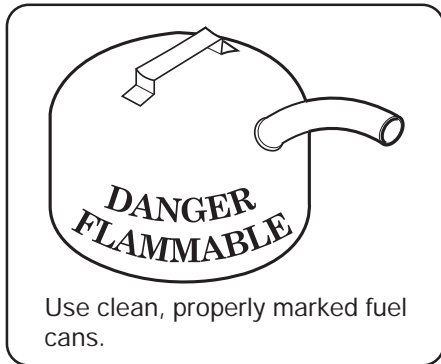

Refueling LPG Tanks

When changing liquefied petroleum gas (LPG), tanks follow these basic rules:

- Change only in well ventilated areas.
- Never allow open flames.
- Turn the ignition switch to the OFF position.
- Check for leaks.
- Check condition of the O-ring.
- Make sure tank is on locating pin.
- Make sure tank latches are securely fastened.
- Store tanks according to local fire codes

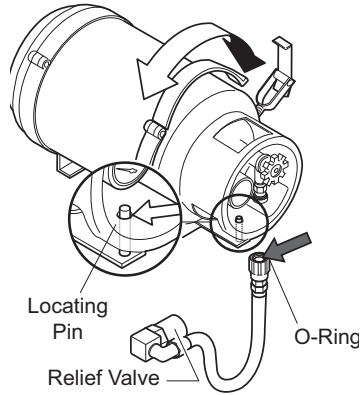

Typical Illustration

If you refill LPG tanks:

- Make sure you know and understand the proper procedure for filling an LPG tank.
- If you have any questions on refilling LPG tanks, please ask your supervisor.

DANGER

LPG IS HEAVIER THAN AIR. It settles on your clothes and the ground around you, displacing oxygen vital for breathing. Open flame can cause flash fires.

IMPORTANT

Check all connections for damage or leaks. If the truck will not start after you change tanks, get a qualified mechanic to check the truck.

RECOMMENDED SAFETY MAINTENANCE PROCEDURES FOR LPG FUELED LIFT TRUCKS

WARNING

LPG is a combustible fuel that is heavier than air. Escaping gas may accumulate in low areas. The fuel cylinder should be mounted so that it does not extend outside the truck and should also be properly positioned by using the locating pin or key way.

The fuel valve should be turned off when the machine is not in service. Cast fittings should not be used in the LPG system. Use only Underwriters Laboratories or Factory Mutual listed LPG hose assemblies where pressure fuel lines are required. All pipe threaded fittings should be installed using an approved sealing compound. Fuel lines should be supported by clamps to minimize chafing and wear. The LPG solenoid valve should be wired to an automatic shut off switch (oil pressure or vacuum) to prevent leakage of gas in the event the ignition is on without the engine running. Check the LPG solenoid or vacuum shutoff valve for leakage as follows:

1. Turn fuel tank valve off, start and run engine until it stops.
2. Install a 0 to 30 psi pressure gauge per instruction A or B:
 - A. To primary test port of single units consisting of primary and secondary regulators.
 - B. Between the primary and secondary stage regulators when the LPG system consists of two regulators.
3. Turn the tank fuel valve on. The pressure gauge should maintain a zero reading. If it does not, the solenoid valve or vacuum shut-off valve must be repaired or replaced. An odor is added to LPG to help indicate leaks. If you detect gas odor, you should turn off the fuel tank supply valve and engine. Remove all sources of ignition, and ventilate the area. Make all of the necessary repairs before you turn the fuel supply on. The complete LPG system should be inspected periodically. Check all hoses for wear, connections for leaks, and all parts for damage.

NOTE: Fuel hoses have a limited life expectancy. They should be checked for cracking and drying due to age. Hoses with visible signs of age should be replaced. Use only Underwriters Laboratories or Factory Mutual listed LPG parts for replacements.

NOTE: The above information is provided as a guide. Consult the National Fire Protection Association Pamphlet 58 for the safe storage and handling of liquefied petroleum gases. Governmental safety regulations in your locality could vary. Check with the authority having jurisdiction to be sure that you meet all of their requirements. Contact the manufacturer for detailed service information.

Emergency Starting and Towing

Contents

How to Tow a Disabled Truck	6-2
How to Use Battery Jumper Cables	6-4



How to Tow a Disabled Truck

If your lift truck becomes disabled but it can be moved freely on its own wheels without further damage, use the following procedures to tow it safely to a repair area.

IMPORTANT

It is important for your safety and the care of your lift truck to use the proper equipment and carefully follow these recommendations for safe towing.



WARNING

DO NOT tow a lift truck if there is a problem with the brakes or tires or the steering cannot be operated. DO NOT tow up or down ramps and steep inclines. DO NOT attempt to tow a lift truck if traction or weather conditions are poor.

1. Be sure to apply the parking brake or block the drive wheels on the disabled truck while working around it.
2. When possible, raise the carriage (forks) on the disabled truck about 12 inches (300 mm) from the floor or ground. Secure the carriage with a chain.
3. Obtain another lift truck of equal or larger size carrying a partial load for traction.
4. Check that the counterweight bolts are in place and properly torqued. (This bolt is made of a special high-tensile steel and is not commercially available. Replace it, when necessary, only with a genuine CLARK replacement part).
5. Use an approved, solid metal tow bar with towing couplers that connect to the towing pins in the counterweights.
6. Release the parking brake on the towed vehicle.
7. Transmission control is in neutral.

NOTICE

DOT approved towing equipment may be available from your CLARK dealer.

8. Tow the disabled truck backward. **An operator must be on the towed truck.** Tow the truck slowly. Careful towing is necessary to prevent injury to personnel or damage to the truck. The truck should be towed at a speed of less than 5 m.p.h. (8 kph) with a driver in the seat. Do not lift the truck or any wheels off the floor or ground while the truck is being towed.

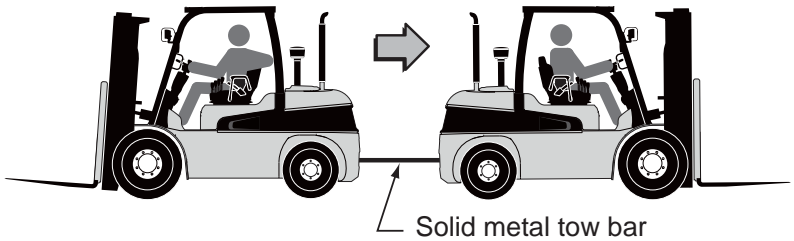

! CAUTION

The power steering and brakes will not operate on the disabled truck when the engine is not running. Manual operation of the handwheel and brakes will be difficult to operate. More manual effort will be required to perform these functions.

9. Park the disabled truck in authorized areas only. Fully lower the forks to the floor, put the directional control lever in the NEUTRAL position and turn the ignition switch to the OFF position. Engage the parking brake. Remove the ignition key and, when necessary, block the wheels to prevent the truck from rolling.

! WARNING

Always engage the parking brake when parking a lift truck. The truck can move and cause injury or death to personnel near it.

How to Use Battery Jumper Cables



CAUTION

If the fork lift truck is laid off for more than 1 month, the (-) cable of battery should be disconnected. Otherwise, the starting of engine will be impossible due to discharge of battery.

If your lift truck battery is discharged (“dead”), you can start your lift truck by “jumping” it from another lift truck that has a 12-volt, negative-ground electrical system. The “booster” battery must be fully charged and in good condition. This section explains how to perform this procedure safely. To avoid damage to your lift truck and your battery or the possibility of harm to yourself, follow the instructions and warnings carefully. If you have any doubts, ask for help from an experienced mechanic.

If your truck has a battery with terminals on the side, you will need a set of jumper cables with matching connector clamps or cable adapters for side-mounted battery terminals.



CAUTION

USE ONLY A 12-VOLT, NEGATIVE GROUND SYSTEM to jump your truck. You can injure yourself and permanently damage your truck’s 12-volt starting motor and ignition system by connecting it to a 24-volt power supply (two 12-volt batteries in series or a 24-volt generating set) or to a positive-ground system.



WARNING

BATTERIES CONTAIN SULFURIC ACID. Avoid acid contact with skin, eyes, or clothing. If acid contacts your eyes or skin, flush immediately with water and get medical assistance. Wear safety glasses when working near the battery to protect against possible splashing of the acid solution.

1. If the discharged battery has filler caps, check the fluid level. Do not use an open flame to check and do not smoke. If low, add distilled water to the correct level. Be sure to install the caps before jump starting.

Do not jump start, charge, or test a sealed-type battery if the test indicator looks illuminated or has a bright color. Install a new battery.



WARNING

BATTERIES EMIT EXPLOSIVE GAS. Do not smoke or have open flames or sparks in battery charging areas or near batteries. An explosion can result and cause injury or death. Hydrogen gas is produced during normal battery operation. Hydrogen can explode if flames, sparks, or lighted tobacco are brought near the battery. When charging or using a battery in an enclosed space, always provide ventilation and shield your eyes. Wear safety glasses when working around batteries.

2. Put the truck with the booster battery as near to the other truck as necessary for the jumper cables to reach both batteries. Check and make sure that the trucks do not touch each other. **Use particular care when connecting a booster battery to prevent sparks.**
3. On both trucks:
 - a. Apply the parking brake.
 - b. Put the directional control lever in the NEUTRAL position.
 - c. Turn the key/start switch to the OFF position.
 - d. Turn all accessories to the OFF position and leave them off until after the engine has been started and the jumper cables have been removed.



WARNING

To avoid SHORT CIRCUITS, remove all jewelry and do not permit any metal tools to make contact between the positive battery terminal and other metal on the truck. When you connect jumper cable clamps to the positive terminals of the two batteries, make sure that neither clamp contacts any other metal. Injury can occur from electrical shock or explosion.



4. Connect the jumper cables in the following sequence:

- a. Connect a jumper cable from the positive (+; red) terminal on one battery to the positive (+; red) terminal on the other battery. Never connect positive (+; red) to negative (-; black), or negative to positive.
- b. Connect one end of the second cable to the grounded negative (-; black) terminal of the "Jumper Vehicle" battery.
- c. Connect the other end of the second cable to a stationary, solid metallic point **on the engine** of the "Stalled Vehicle," **not to the negative (-; black) terminal** of its battery. Make this connection at a point at least 18 inches (450 mm) away from the battery, if possible. Do not connect it to pulleys, fans or other parts that move. Do not touch hot manifolds that can cause severe burns.

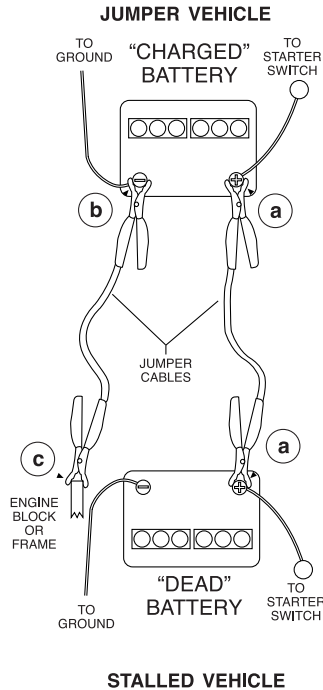

5. Start the engine on the "Jumper Vehicle" and run the engine at a moderate speed for a minimum of five minutes.
6. Start the engine on the "Stalled Vehicle." Follow the starting instructions in Section 4, "Operating Procedures" in this manual. Be sure that the engine is at idle speed before disconnecting the jumper cables.
7. Remove the jumper cables by reversing the installation sequence exactly. Start by removing the last jumper cable from the stalled vehicle first. Remove the cable end from the engine block first, then the other end of the negative (-; black) cable.
8. Remove both ends of the positive (+; red) cable.

Planned Maintenance and Lubrication

Contents

Introduction	7-2
Safe Maintenance Practices	7-3
Major Component Locations	7-8
Planned Maintenance Intervals	7-9
PM Report Form	7-12
How to Perform Planned Maintenance	7-14

NOTICE

THIS SECTION IS FOR TRAINED SERVICE PERSONNEL to use as a reference for Planned Maintenance procedures. Complete maintenance information is in the Service Manuals.



Introduction

NOTICE

ONLY TRAINED AND AUTHORIZED PERSONNEL should perform **Planned Maintenance**. Local **CLARK** dealers are prepared to help customers put in place a **Planned Maintenance program** for checking and maintaining their lift trucks according to applicable safety regulations.



CAUTION

Powered industrial trucks may become hazardous if maintenance is neglected.

The operator should make a safety inspection of the lift truck before operating it. The purpose of this daily examination is to check for any obvious damage and maintenance problems, and to have minor adjustments and repairs made to correct any unsafe condition.

In addition to the operator's daily inspection, CLARK recommends that the owner set up and follow a periodic planned maintenance (PM) and inspection program. Performed on a regular basis **by trained** personnel, the program provides thorough inspections and checks of the safe operating condition of the lift truck. The "PM" identifies needed adjustments, repairs, or replacements so they can be made before failure occurs. The specific schedule (frequency) for the PM inspections depends on the particular application and lift truck usage.

This Section recommends typical Planned Maintenance and Lubrication Schedules for items essential to the safety, life, and performance of the truck. It also outlines safe maintenance practices and gives brief procedures for inspections, operational checks, cleaning, lubrication, and minor adjustments.

Specifications for selected components, fuel, lubricants, critical bolt torques, refill capacities, and settings for the truck are found in Section 8.

If you have need for more information on the care and repair of your truck, see your CLARK dealer.

Safe Maintenance Practices

The following instructions have been prepared from current industry and government safety standards applicable to industrial truck operation and maintenance. These recommended procedures specify conditions, methods, and accepted practices that aid in the safe maintenance of industrial trucks. They are listed here for the reference and safety of all workers during maintenance operations. Carefully read and understand these instructions and the specific maintenance procedures before attempting to do any repair work. When in doubt of any maintenance procedure, please contact your local CLARK dealer.

1. Powered industrial trucks can become hazardous if maintenance is neglected. Therefore, suitable maintenance facilities and trained personnel and procedures shall be provided.
2. Maintenance and inspection of all powered industrial trucks shall be performed in conformance with the manufacturer's recommendations.
3. Follow a scheduled planned maintenance, lubrication, and inspection system.
4. Only trained and authorized personnel are permitted to maintain, repair, adjust, and inspect industrial trucks and must do so in accordance with the manufacturer's specifications.
5. Always wear safety glasses. Wear a safety (hard) hat in industrial plants and in special work areas where protection is necessary and required.
6. Properly ventilate work area, vent exhaust fumes, and keep shop clean and floors dry.
7. Avoid fire hazards and have fire protection equipment present in the work area. Do not use an open flame to check for leakage. Do not use open pans of fuel or flammable cleaning fluids for cleaning parts.
8. Before starting work on truck:
 - a. Raise drive wheels free of floor and use oak blocks or other positive truck positioning devices.
 - b. Remove all jewelry (watches, rings, bracelets, etc.).
 - c. Put oak blocks under the load-engaging means, innermasts, or chassis before working on them.
 - d. Disconnect the battery ground cable (-) before working on the electrical system.





CAUTION

Refer to the “Jacking and Blocking” section in the Service Manual for proper procedures.

9. Operation of the truck to check performance must be conducted in an authorized, safe, clear area.
10. Before starting to operate the truck:
 - a. Be seated in a safe operating position and fasten your seat belt.
 - b. Make sure parking brake is applied.
 - c. Put the direction control in NEUTRAL.
 - d. Start the engine.
 - e. Check functioning of lift and tilt systems, direction and speed controls, steering, brakes, warning devices, and load handling attachments.
11. Before leaving the truck:
 - a. Stop the truck.
 - b. Fully lower the load-engaging means: upright, carriage, forks or attachments.
 - c. Put the directional control in NEUTRAL.
 - d. Apply the parking brake.
 - e. Stop the engine.
 - f. Turn the key switch to the OFF position.
 - g. Put blocks at the wheels if the truck must be left on an incline.
12. Brakes, steering mechanisms, control mechanisms, warning devices, lights, governors, lift overload devices, lift and tilt mechanisms, articulating axle stops, load back rest, overhead guard and frame members must be carefully and regularly inspected and maintained in a safe operating condition.
13. Special trucks or devices designed and approved for hazardous-area operation must receive special attention to insure that maintenance preserves the original approved safe operating features.

14. Fuel systems must be checked for leaks and condition of parts. Extra special consideration must be given in the case of a leak in the fuel system. Action must be taken to prevent the use of the truck until the leak has been corrected.
15. All hydraulic systems must be regularly inspected and maintained in conformance with good practice. Tilt and lift cylinders, valves, and other parts must be checked to assure that "drift" or leakage has not developed to the extent that it would create a hazard.
16. When working on the hydraulic system, be sure the engine is turned off, upright is in the fully-lowered position, and hydraulic pressure is relieved in hoses and tubing.



WARNING

Always put oak blocks under the carriage and upright rails when it is necessary to work with the upright in an elevated position.

17. The truck manufacturer's capacity, operation, and maintenance instruction plates, tags, or decals must be maintained in legible condition.
18. Batteries, limit switches, protective devices, electrical conductors, and connections must be maintained in conformance with good practice. Special attention must be paid to the condition of electrical insulation.
19. To avoid injury to personnel or damage to the equipment, consult the manufacturer's procedures in replacing contacts on any battery connection.
20. Industrial trucks must be kept in a clean condition to minimize fire hazards and help in detection of loose or defective parts.
21. Modifications and additions that affect capacity and safe truck operation must not be done without the manufacturer's prior written approval. Capacity, operation, and maintenance instruction plates, tags, or decals must be changed accordingly.

22. Care must be taken to assure that all replacement parts, including tires, are interchangeable with the original parts and of a quality at least equal to that provided in the original equipment. Parts, including tires, are to be installed per the manufacturer's procedures. Always use genuine CLARK or CLARK-approved parts.



WARNING

When removing tires follow industry safety practices. Most importantly, deflate pneumatic tires completely prior to removal. Following assembly of tires on multi-piece rims, use a safety cage or restraining device while inflating.

23. Use special care when removing heavy components, such as counterweight, upright, etc. Be sure that lifting and handling equipment is of the correct capacity and in good condition.

IMPORTANT

Your new CLARK lift truck has been built to meet all applicable mandatory requirements of ANSI / ITSDF B56.1 Safety Standard for Powered Industrial Trucks. Each truck also includes certain safety devices—such as horn, overhead guard, safety restraint system, seat belt and load back rest—as standard equipment. No additions, omissions, or modifications should be made that affect compliance to the above requirements or in any way minimize the effectiveness of the safety devices.

NOTICE

You should be familiar with additional operating and maintenance safety instructions contained in the following publications:

ANSI / ITSDF B56.1: Safety Standard for Low Lift and High Lift Trucks (Safety Code For Powered Industrial Trucks).

NFPA 505: Fire Safety Standard for Powered Industrial Trucks: Type Designations, Areas of Use, Maintenance and Operation. Available from National Fire Protection Association, Inc., Batterymarch Park, Quincy, MA 02169.

General Industrial Standards, OSHA 2206: OSHA Safety and Health Standards (929 CFR 1910), Subpart N-Materials Handling and Storage, Section 1910.178 Powered Industrial Trucks. For sale by: Superintendent of Documents, US Government Printing Office, Washington, DC 20210.



Major Component Locations

Use the illustration below to help locate components included in the PM procedures.

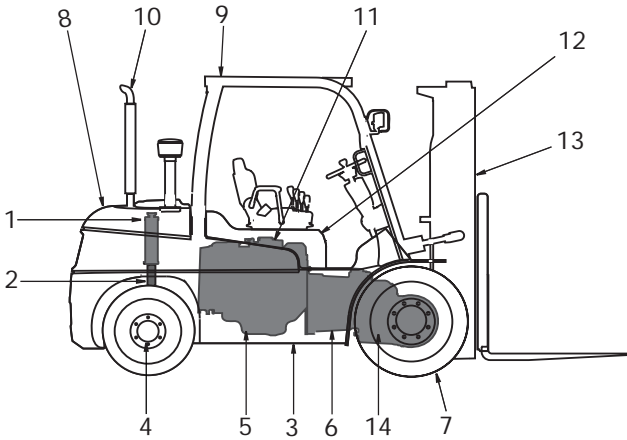

- | | |
|------------------------|--------------------------|
| 1. Radiator | 8. Counterweight |
| 2. Transmission Cooler | 9. Overhead Guard |
| 3. Frame | 10. Exhaust |
| 4. Steer Axle | 11. Carburetion |
| 5. Engine | 12. Sheet Metal |
| 6. Transmission | 13. Upright and Carriage |
| 7. Wheels and Tires | 14. Drive axle |

The truck shown above is a typical representation of a CLARK internal combustion lift truck. Your model may vary slightly.

Planned Maintenance Intervals

Time intervals between maintenances are largely determined by operating conditions. For example, operation in sandy, dusty locations requires shorter maintenance intervals than operation in clean warehouses. The indicated intervals are intended for **normal** operation. The operating condition classifications are:

Normal Operation

Eight-hour material handling, mostly in buildings or in clean, open air on clean paved surfaces.

Severe Operation

Prolonged operating hours or constant usage.

Extreme Operation

- In sandy or dusty locations, such as cement plants, lumber mills, and coal dust or stone crushing sites.
- High-temperature locations, such as steel mills and foundries.
- Sudden temperature changes, such as constant trips from buildings into the open air, or in refrigeration plants.

If the lift truck is used in severe or extreme operating conditions, you must shorten the maintenance intervals accordingly.

NOTICE

Since the operating environment of lift trucks varies widely, the above descriptions are highly generalized and should be applied as actual conditions dictate.



The maintenance time intervals referred to in this manual relate to truck operating hours as recorded on the hourmeter, and are based on experience CLARK has found to be convenient and suitable under typical (normal or average) operating conditions. The periods and their designations are:

PM Interval:

A=8 - 10 hours or daily

B=50 - 250 hours or every month (typical PM interval)

C=450 - 500 hours or every 6 months

D=900 - 1000 hours or every 12 months

E=2000 hours or every year

PERIODIC CHECKS and PLANNED MAINTENANCE (PM)	A	B	C	D	E
Check truck visually and inspect components.			•		
Test drive truck/check functional performance.			•		
Air clean truck and radiator.			•		
Check torque on critical fasteners.			•		
Lubricate truck. (See component)			•		
Replace LPG engine oil and filter.			•		
Replace Diesel engine oil and filter.			•		
Clean and replace LPG engine air filter. (*)					•
Clean and replace Diesel engine air filter. (*)				•	
Change Diesel fuel filter (KUBOTA,IVECO)			•		
Change Diesel fuel filter (DEUTZ)				•	
Change LPG fuel filter				•	
Inspect / adjust fan belts.			•		
Drain / flush radiator coolant.					•
Check engine ignition and timing.			•		
Engine tune-up.					•
Check battery.			•		
Check transmission fluid level.			•		
Change transmission fluid.				•	
Change transmission oil filter.			•		
Clean drive axle air vent.				•	
Check brake condition and wear.			•		
Check drive axle mounting and fasteners.				•	
Lubricate steer axle linkage.				•	
Check / lubricate steer axle wheel bearings.					•
Change / replace hydraulic sump oil filter and breather. (**)				•	
Change / replace hydraulic sump fluid and oil filter. (**)					•
Lubricate tilt cylinder rod ends.			•		
Check lift chain adjustment and wear.			•		
Check / lubricate lift chains.			•		
Lubricate upright rollers.			•		

NOTES:

- * Air filter change interval may be determined by using an air restriction indicator.
- ** Hydraulic filter change interval may be determined by hydraulic filter restriction indicator.

DAILY MAINTENANCE CHECKS	A	B	C	D	E
Check truck for obvious damage and leaks.	•				
Check fuel system for leaks, etc.	•				
Check capacity, warning plates and decals.	•				
Check condition of tires and wheels. Remove embedded objects. Check air pressure.	•				
Check for missing or loose wheel lugs nuts.	•				
Check engine oil level.	•				
Check engine coolant level (radiator and recovery tank)	•				
Check transmission fluid level	•				
Check fuel level.	•				
Check hydraulic sump oil level.	•				
Check gauges and instruments.	•				
Check warning lights and hour meter.	•				
Check overhead guard condition and bolts.	•				
Check horn operation and other warning devices.	•				
Check steering operation.	•				
Check service brake operation.	•				
Check parking brake operation.	•				
Check parking brake linkage for damage, broken parts.	•				
Check directional and speed controls operation.	•				
Check accelerator and engine speed operation.	•				
Check lift, tilt and aux. operation.	•				
Check upright, lift chains and fasteners.	•				
Check carriage or attachments and forks.	•				
Check seat deck hold-down latch for correct locking.	•				
Check optional safety equipment. (alarms, lights etc.)	•				

PM Report Form

Make and keep records of your PM inspections. Use these records to help establish the correct PM intervals for the truck application and to indicate maintenance required to prevent major problems from occurring during operation.

As an aid in performing and documenting your PM inspections, CLARK has prepared a **Gas, LPG, or Diesel Planned Maintenance Report Form**. Copies of this form may be obtained from your authorized CLARK dealer. We recommend that you use this form as a checklist and record of your inspection and truck condition.

The maintenance procedures outlined in this Section are intended to be used in conjunction with the PM Report Form. They are arranged in a logical and efficient sequence.

You make a check mark or entry on the PM Report Form when the PM is performed. A special coding system for indicating the importance of needed repairs and/or adjustments appears on the form.

When you have finished the PM inspections, be sure to give a copy of the report to the designated authority or person responsible for lift truck maintenance.

Do not make repairs or adjustments unless authorized to do so.



CAUTION

For safety, it is good practice to:

- **Remove all jewelry (watch, rings, bracelets, etc.) before working on the truck.**
- **Disconnect the battery ground cable (-) from the battery before working on electrical components.**
- **Always wear safety glasses. Wear a safety (hard) hat in industrial plants and in special work areas where protection is necessary and required.**

How to Perform Planned Maintenance

Visual Inspection

First, perform a visual inspection of the lift truck and its components. Walk around the truck and take note of any obvious damage or maintenance problems.

Check to be sure all capacity, safety, and warning plates are attached and legible.

NOTICE

NAME PLATES AND DECALS: Do not operate a lift truck with damaged or lost decals and nameplates. Replace them immediately. They contain important information.

Inspect the truck, before and after starting the engine, for any sign of external leakage of fuel, engine coolant, transmission fluid, etc.

Check for hydraulic oil leaks and loose fittings.



CAUTION

HYDRAULIC FLUID PRESSURE: Do not use your hands to check for hydraulic leakage. Fluid under pressure can penetrate your skin and cause serious injury.

Overhead Guard

Be sure that the driver's overhead guard and any safety devices are in place, undamaged, and attached securely.

Check the overhead guard for damage. Be sure that it is properly positioned and all mounting fasteners are in place and tight.

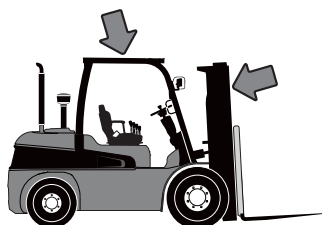

Load Handling Components

Inspect the upright assembly, load backrest (LBR), rails, carriage rollers, lift chains, and lift and tilt cylinders. Look for obvious wear and maintenance problems and damaged or missing parts. Check for any loose parts or fittings. Check for leaks, damaged or loose rollers, and rail wear (metal flaking). Carefully check the lift chains for

wear, rust, corrosion, cracked or broken links, stretching, etc. Check that the lift and carriage chains are correctly adjusted to have equal tension. Check that the lift chain anchor fasteners and locking means are in place and tight. Inspect all lift line hydraulic connections for leaks.

IMPORTANT

Uprights and lift chains require special attention and maintenance to remain in safe operating condition. Refer to “Lift Chain Maintenance” in this Section for additional information.

Forks

Inspect the load forks for cracks, breaks, bending, and wear. The fork top surfaces should be level and even with each other. The height difference between both fork tips should be no more than 1.5% of the blade length.

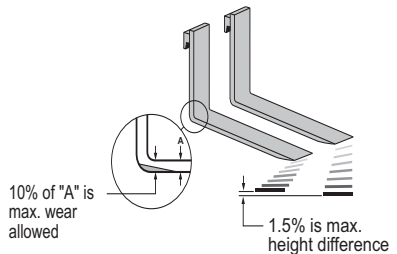

WARNING

If the fork blade at the heel is worn down by more than 10 %, the load capacity is reduced and the fork must be replaced.

Inspect the forks for twists and bends. Put a 2"-thick metal block, at least 4" wide by 24" long with parallel sides, on the blade of the fork with the 4" surface against the blade. Put a 24" carpenter's square on the top of the block and against the shank. Check the fork 20" above the blade to make sure it is not bent more than 1" maximum.

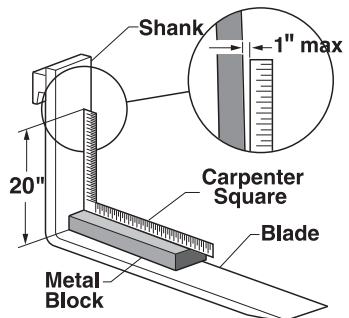

If the fork blades are obviously bent or damaged, have them inspected by a trained maintenance person before operating the truck.

Inspect the fork locking pins for cracks or damage. Reinsert them and note whether they fit properly.

Wheels and Tires

Check the condition of the drive and steer wheels and tires. Remove objects that are embedded in the tread. Inspect the tires for excessive wear and breaks or “chunking out.”

Check all wheel lug nuts or bolts to be sure none are loose or missing. Replace missing bolts or lug nuts. Torque loose or replaced items to specifications.

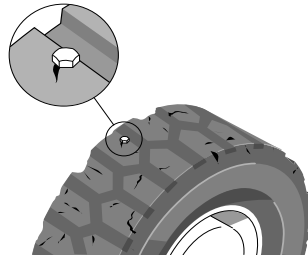

WARNING

Check tire pressure from a position facing the tread of the tire, not from the side. Use a long-handled gauge to keep your body away from the side. If tires are low, do not operate and do not add air. Check with a mechanic. The tire may require removal and repair. Incorrect (low) tire pressure can reduce the stability of your lift truck. Do not operate truck with low tire pressure. Proper cold inflation is 100 psi.

Disassembling the split rim wheel

When you disassemble the split-rim wheel, NEVER remove the tire before you deflate the tire pressure. First, deflate the tire pressure and then loosen the wheel bolts and nuts. Failure to do so could result in serious personal injury. This work should be performed only by a trained and authorized mechanic.

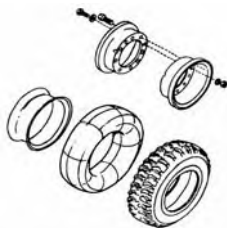

Functional Tests

You will start the engine to complete the functional tests, so be sure that:

- The parking brake is applied.
- Directional control is in NEUTRAL.
- Forks are fully lowered to the floor or ground
- All controls are in neutral or other correct position
- You are familiar with the safety procedures given in Section 4, "Operating Procedures," in this manual.

As you test the following components, be sure they are properly mounted and working correctly.

Horn

Press the horn button to check horn function. If the horn or any other part does not operate, report the failure and have it repaired before the truck is put into operation.

Neutral Start Switch

Check the operation of the neutral start switch by placing the direction control lever in FORWARD or REVERSE and turning the key switch to START position. The starter must not engage until the direction control lever is moved to the NEUTRAL position.

Hour Meter

Start the engine and let it warm up until it runs evenly and accelerates smoothly when you push on the accelerator pedal. Check the hour meter for operation with the engine running. Write the hour meter reading on the PM report form. Report any malfunction or damage.

Indicator Lights

Check that all lights are functioning and indicate normal truck operation as described in Section 3, "Operator Compartment and Controls," in this manual.

Service Brakes and Inching Pedal

With the direction control in NEUTRAL and the engine running, push the service brake pedal fully down and hold. The brakes should apply before the pedal reaches the floorplate. If the pedal continues to creep downward, report the failure immediately. **Do not operate the truck until the brakes are repaired.** Perform the same check with the inching pedal. (Additional braking/inching checks will follow.)

Parking Brake

Check the function of the parking brake. Pushing down, then pulling the lever upwards. To check parking brake holding capability, park the lift truck on a grade and apply the parking brake. The parking brake should hold a lift truck with rated load on a 15% grade.

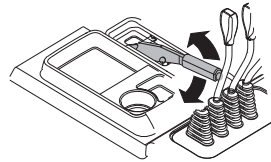

CAUTION

Do not operate a lift truck if the service or parking brakes are not operating properly.

Lift Mechanisms and Controls

Pull back on the tilt control lever and hold until the upright reaches the full back tilt position. Push forward on the lever to return the upright to the vertical position. Release the lever.

CAUTION

Be sure that there is adequate overhead clearance before raising the upright.

Pull back on the lift control lever and raise the fork carriage to full height. Watch the upright assembly as it rises. Release the lever.

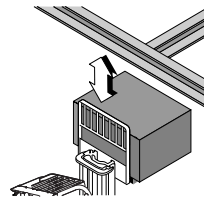

If the maximum fork height is not reached, this indicates there is an inadequate (low) oil level in the hydraulic sump tank or severe binding within the upright.

Push forward on the lift control lever. Watch the upright as it lowers. When the forks reach the floor, release the lever.

All movements of the upright, fork carriage, and lift chains must be even and smooth, without binding or jerking. Watch for chain wobble or looseness; the chains should have equal tension and move smoothly without noticeable wobble.

Auxiliary Controls (Option)

If your lift truck is equipped with an attachment, test the control lever for correct function and briefly operate the attachment.

Steering System

NOTICE

The steering system, steer axle, and steering linkage on your truck should be inspected periodically for abnormal looseness and damage, leaking seals, etc. Also, be alert for any changes in steering action. Hard steering, excessive freeplay (looseness), or unusual sound when turning or maneuvering indicates a need for inspection or servicing.

Check the steering system by moving the steering handwheel in a full right turn and then in a full left turn. Return the handwheel to the straight-ahead position. The steering system components should operate smoothly when the handwheel is turned. **Never operate a truck that has a steering system fault.**



WARNING

Fasten your seat belt before driving the truck.

Direction Control, Braking, and Inching

Be sure that the travel area is clear in front of the truck.

1. Push firmly on the brake pedal. Release the parking brake. Move the directional control lever from NEUTRAL to FORWARD.

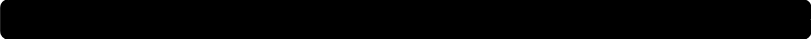
- 
2. Remove your right foot from the service brake pedal and put it on the accelerator pedal. Push down until the truck moves slowly forward. Remove your foot from the accelerator pedal and push down on the service brake pedal to stop the truck. The brakes should apply smoothly and equally.

Be sure the travel area is clear behind the truck.

3. Put the directional control lever in the REVERSE travel position. Release the service brake and push down on the accelerator pedal until the truck moves slowly in the reverse direction. Remove your foot from the accelerator pedal and push down on the service brake pedal to stop the truck. The brakes should apply smoothly and equally.
4. Put the directional control in FORWARD. Press the inching pedal fully down and hold. Depress the accelerator. The truck should not move. Now, with the accelerator still depressed, slowly release the inching pedal until the truck “inches” forward smoothly and slowly.

Report any problems.

When you have completed the operational tests, park and leave the truck according to standard shut down procedure as described in Section 4 of this manual. Be sure to make a record of all maintenance and operating problems you find.

Fluids, Filters, and Engine Accessories

To check fluid levels and other components within the engine compartment, unlatch and open the hood to access the engine compartment.



CAUTION

To avoid the possibility of personal injury, never work in the engine compartment with the engine running, except when it is absolutely necessary to check or make adjustments. Take extreme care to keep hands, tools, loose clothing, etc., away from fan and drive belts. Also remove watches, bracelets, and rings.

Engine Accessories

Inspect the engine coolant hoses and fan belt(s). Look for leaking and obvious damage, worn (frayed) condition, breaks, etc. that could cause failure during operation.

Engine Air Cleaner

Check the engine air cleaner for damage and contamination (excessive dirt buildup and clogging). Be sure that the air cleaner hose is securely connected (not loose or leaking). Fan or cone shaped dust deposits on tube or hose surfaces indicate a leak.

Change or service the air cleaner element every 2000 operating hours for gas engine, every 1000 operating hours for diesel engine, depending upon your application. Service intervals may also be determined by the air restriction indicator.

Battery

Inspect the battery for damage, cracks, leaking condition, etc. If the terminals are corroded, clean and protect them with CLARK Battery Saver (available from your CLARK dealer). If your battery has removable cell caps, check to be sure the cells are all filled. Refill them with distilled water.



WARNING

EXPLOSIVE GASES: Do not smoke or have open flames or sparks near batteries. An explosion can cause injury or death.

Engine Cooling System

To check engine coolant level open the hood to the engine compartment. Visually inspect the recovery bottle, locate the “HOT” and “COLD” marks. The “HOT” mark indicates maximum level at operating temperature. The “COLD” mark indicates additional coolant needs to be added to the system.

The recovery bottle shown is a typical illustration of overflow system. Your actual system may vary slightly.

A level anywhere between the HOT and COLD marks is normal.

Inspect the coolant level in the overflow bottle only.

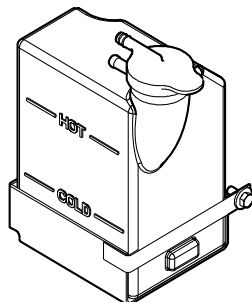

 **WARNING**

Do not remove the radiator cap when the radiator is hot. STEAM from the radiator will cause severe burns. Do not remove the radiator cap to check the coolant level.

 **WARNING**

Never remove the radiator cap while the engine is running. Stop the engine and wait until it has cooled. Failure to do so could result in serious personal injury from hot coolant or steam blowout and/or damage to the cooling system or engine.

If the level is low, add a 50/50 mixture of specified coolant and water to the correct fill level. If you have to add coolant more than once a month or if you have to add more than one quart at a time, check the coolant system for leaks.

- Check engine oil for presence of coolant leaking into engine.
- Inspect the coolant for condition. Look for excessive contamination or rust or oil in the coolant solution.
- Check the PM time interval for need to change coolant.
- Check the condition of radiator cap rubber seal and radiator filler neck for damage. Be sure they are clean.
- Check overflow hose for clogging or damage.

NOTICE

Your lift truck cooling system is filled with a factory-installed solution of 50% water and 50% permanent-type antifreeze containing rust and corrosion inhibitors. You should leave the solution in year around. Plain water may be used in an emergency, but replace it with the specified coolant as soon as possible to avoid damage to the system. Do not use alcohol or methanol antifreeze.

Engine Oil and Filter

Locate the engine oil dipstick. Pull the dipstick out, wipe it with a clean wiper, and reinsert it fully into the dipstick tube. Remove the dipstick and check oil level.

It is normal to add some oil between oil changes. Keep the oil level above the ADD mark on the dipstick by adding oil as required. Do not overfill. Use the correct oil as specified under Lubricant Specifications.

It is recommended to:

- Drain and replace the engine crankcase oil every 500 operating hours. (depending on application). See NOTICE
- Engine Oil Filter must be changed at every PM when the oil is changed.
- Remove the oil pan drain plug to drain old oil after the truck has been in operation and the engine (oil) is at operating temperature.

**WARNING**

Engine oil at operating temperature is hot and can cause burns. Beware of splashing oil.

- Carefully check for leaks after changing oil and installing new filter.

NOTICE

The time interval for changing engine oil depends upon your application and operating conditions. To determine the correct schedule for your truck, it is suggested that you periodically submit engine oil samples to a commercial laboratory for analysis of the condition of the oil.

ENGINE OIL PERFORMANCE DESIGNATION

: Refer to the “Engine Oil” in Section 8.

Hydraulic Sump Tank

Check the hydraulic sump tank fluid level. Correct fluid level is important for proper system operation. Low fluid level can cause pump damage. Overfilling can cause loss of fluid or lift system malfunction.

Hydraulic fluid expands as its temperature rises. Therefore, it is preferable to check the fluid level at operating temperature (after approximately 30 minutes of truck operation). To check the fluid level, first park the truck on a level surface and apply the parking brake. Put the upright in a vertical position and lower the fork carriage fully down. Pull the dipstick out, (attached to the sump breather) wipe it with a clean wiper, and reinsert it. Remove dipstick and check oil level. Keep the oil level above the LOW mark on the dipstick by adding recommended hydraulic fluid only, as required. **Do not overfill.**

Check the condition of the hydraulic fluid (age, color or clarity, contamination). Change (replace) the oil as necessary.

Hydraulic Fluid and Filter Change

Drain and replace the hydraulic sump fluid every 2000 operating hours. (Severe service or adverse conditions may require more frequent fluid change). Replace the hydraulic oil filter elements at every oil change. Remove, clean, and reinstall the hydraulic and steer system suction line screens at first PM and every 1000 hours thereafter. Check for leaks after installation of the filters. Also, check that the hydraulic line connections at the filter adapter are tightened correctly. The procedure for draining hydraulic sump tank is in your Service Manual.

Sump Tank Breather Maintenance and Inspection

Remove the sump tank fill cap/breather and inspect for excessive (obvious) contamination and damage. Replace the fill cap/breather, per recommended PM schedule or as required by operating conditions.

Transmission Fluid Check

Before checking, run the engine until the unit is at operating temperature. This is important since transmission oil temperature should be minimum of 150°F to 250°F of maximum, the engine should also be at operating temperature. Apply the parking brake. With the engine operating at idle and the transmission in NEUTRAL, and the parking brake set, check the fluid on the dipstick. Fill, if necessary, to the FULL mark on the dipstick, using CLARK transmission fluid. If unable to determine actual oil temperature, use this alternate check method: With the unit cold, start and run the engine at idle for 30 seconds then check the level and fill only to the add mark.

NOTICE

Check the planned maintenance interval (operating hours) or the condition of the oil to determine if the transaxle fluid needs to be changed.

Lubrication

Truck Chassis Inspection and Lubrication

Lubrication and inspection of truck chassis components, including steer wheels, steer axle linkage, steering cylinder, and wheel bearings are easier if the truck is raised and blocked up under the frame. Refer to your Service Manual for additional information on machine blocking and jacking. Also refer to your Service Manual for the location of grease fittings.



WARNING

Do not raise the truck by lifting under the counterweight.

Inspect the steering cylinder piston rods, seals, and fasteners for damage, leaks, and looseness. Lubricate the steer axle linkage rod ends and linkage pivot points. Be sure to clean the grease fittings before lubricating, and remove the excess grease from all points after lubricating. Lubricate miscellaneous linkage as needed.

Upright and Tilt Cylinder Lubrication

Clean the fittings and lubricate the tilt cylinder rod end bushings (forward end) and both the base rod-end bushings (rear end). Clean and lubricate the upright trunnion bushings.

Lift Chains

Lubricate the entire length of the upright rail lift and carriage chains with CLARK Chain and Cable Lube.

IMPORTANT

Do not lubricate the carriage roller rails.

Air Cleaning

Always maintain a lift truck in a clean condition. Do not allow dirt, dust, lint, or other contaminants to accumulate on the truck. Keep the truck free from leaking oil and grease. Wipe up all oil spills. Keep the controls and floorboards clean, dry, and safe. A clean truck makes it easier to see leakage and loose, missing, or damaged parts, and helps prevent fires. A clean truck runs cooler. The environment in which a lift truck operates determines how often and to what extent cleaning is necessary.

For example, trucks operating in manufacturing plants that have a high level of dirt, dust, or lint (for example, cotton fibers or paper dust) in the air or on the floor or ground, require more frequent cleaning. The radiator especially may require daily air cleaning to ensure correct cooling. If air pressure does not remove heavy deposits of grease, oil, etc., it may be necessary to use steam or liquid spray cleaner.

IMPORTANT

Lift trucks should be air cleaned at every PM interval, or more often if necessary.

Use an air hose with special adapter or extension, a control valve, and a nozzle to direct the air properly. Use clean, dry, low pressure, compressed air. Restrict air pressure to 30 psi (207 kPa), maximum. (OSHA requirement.)



CAUTION

Wear suitable eye protection and protective clothing when air cleaning. Never point the air nozzle at anyone.

Air clean the upright assembly, drive axle, radiator—from both counterweight and engine side, engine and accessories, driveline and related components, and steer axle and cylinder.

Critical Fastener Torque Checks

Fasteners in highly loaded (critical) components can quickly fail if they become loosened. Also, loose fasteners can cause damage or failure of the component. For safety, it is important that the correct torque be maintained on all critical fasteners of components that directly support, handle, or control the load and protect the operator.

Critical items include:

- Drive axle mounting
- Overhead guard
- Drive and steer wheel mounting
- Tilt cylinder mounting and yokes
- Counterweight mounting
- Upright mounting and components

Torque specifications are in your Service Manual.

Lift Chain Maintenance

The chain system on the upright was designed for safe, efficient, and reliable transmission of lifting force from hydraulic cylinder to the forks. Safe use of your truck with minimum down-time depends on the correct care and maintenance of the lift chains. Most complaints of unacceptable chain performance are a result of poor maintenance. Chains need periodic maintenance to give maximum service life.



WARNING

Do not attempt to repair a worn chain. Replace worn or damaged chains. Do not piece chains together.

Lift Chain Inspection and Measurement

Inspect and lubricate the lift chains every PM (50-250 hours). When operating in corrosive environments, inspect the chains every 50 hours. During the inspection, check for the following conditions:

- Rust and corrosion, cracked plates, raised or turned pins, tight joints, wear, and worn pins or holes.
- When the pins or holes become worn, the chain becomes longer. When a section of chain is 3% longer than a section of new chain, the chain is worn and must be discarded.
- Chain wear can be measured by using a chain scale or a steel tape measure. When checking chain wear, be sure to measure a segment of chain that moves over a sheave. Do not repair chains by cutting out the worn section and joining in a new piece. If part of a chain is worn, replace all the chains on a truck.

Lift Chain Lubrication

Lift chain lubrication is an important part of your maintenance program. The lift chains operate under heavy loadings and function more safely and have longer life if they are regularly and correctly lubricated. CLARK chain lubricant is recommended; it is easily sprayed on and provides superior lubrication. Heavy motor oil may also be used as a lubricant and corrosion inhibitor.

Lift Chain Wear and Replacement Criteria:

1. (NEW CHAIN LENGTH) The distance from the first pin counted to the last pin counted in a span while the chains are lifting a small load.
2. (WORN CHAIN LENGTH) The distance from the first pin counted to the last pin counted in a span while the chains are lifting a small load.

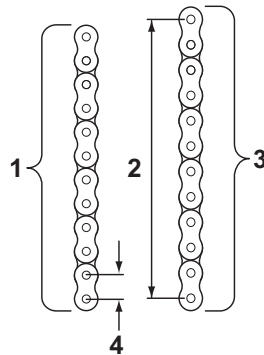

3. (SPAN) The number of pins in the length (segment) of chain to be measured.
4. (PITCH) The distance from the center of one pin to the center of the next pin.

All chains must be replaced if any link has wear of 3% or more, or if any of the damaged conditions noted above are found during inspection. Order replacement chains from your CLARK dealer. Replace all chains as a set. Do not remove factory lubrication or paint new chains. Replace anchor pins and worn or broken anchors when installing new chains. Adjust tension on new chains. Lubricate chains when they are installed on the upright.

NOTICE

Please refer to your Service Manual for additional information on lift chain measurement and maintenance.

Specifications

Contents

C40-55s	8-2
C60-80	8-5
Engine Oil	8-8



C40-C55s

CLARK products and specifications are subject to improvements and changes without notice or obligation.

Model Designation - Rated Load Capacity

C40	4000 kg @500mm load center	[8810 lbs @20in]
C45	4500 kg @500mm load center	[9920 lbs @20in]
C50s	5000 kg @500mm load center	[11020 lbs @20in]
C55s	5500 kg @500mm load center	[12120 lbs @20in]

Note: Rated capacity applies when using standard upright.
[C40-50s : 3000mm, C55s : 2800mm MFH]

Engine

	<u>Diesel</u>	<u>Diesel</u>	<u>LPG</u>	<u>LPG</u>
Model :	KUBOTA V3800T	DEUTZ TD3.6	GM V6	PSI 4X
Cylinders :	4	4	6	6
Displacement cubic inches :	230	219	262	262
liters :	3.8	3.6	4.3	4.3
Idle RPM :	800	850	750	750
Rated RPM :	2400	2200	2400	2400
Rated kW :	68.6	55.4	75	82

Cooling System

Automotive type crossflow radiator.

Cooling system pressure (radiator cap): 88 kPa nominal, 12.8psi

Thermostat: Diesel & LPG, 82°C (180°F), fully open 95°C (203°F)

Powershift Transmission

Speed : 2 Forward / 2 Reverse

Overall Ratios : 1st - 2.550 : 1

2nd - 1.218 : 1 (Diesel)

1.448 : 1 (LPG)

Converter Stall Ratio : 2.382 : 1

Drive Axle

Full floating straight drive axle. 4 pinion differential with wet disk brakes

Wheels and Tires

Drive	C40	Single : 8.25×15-14PR.....	820kpa (119psi)
	C45	Single : 8.25×15-16PR.....	951kpa (138psi)
	C50s	Single : 300×15-18PR.....	820kpa (119psi)
	C55s	Single : 300×15-20PR.....	951kpa (138psi)
	C40-55s	Dual : 7.50×15-12PR.....	820kpa (119psi)
Steer	C40-55s	7.50×12-14PR.....	1000kpa (145psi)

Standard Electrical System

Type: 12 volt DC, negative ground Fuses: 10, 20 amps

Batteries: BCI Group 45

Fuel Recommendations

Diesel: D-2 with cetane rating of 45 or higher.
 D-1 and Jet A-1 also acceptable.

LPG: HD-5 propane

Fill Capacities *(fluid volumes-liters, quarts, gallons,kilogram,pound)*

	Cooling system	Eng.oil,w/ filter	Transmis-sion	Hydraulic sump	Fuel tank
C40-45D	18L[18.9Q]	8L[8.4Q]	12L[12.6Q]	88L[23.2G]	94L[24.8G]
C50s-55sD	18L[18.9Q]	8L[8.4Q]	12L[12.6Q]	100L[26.4G]	106L[28.0G]
C40-45L	18L[18.9Q]	7.5L[7.9Q]	12L[12.6Q]	88L[23.2G]	20kg[44 lb]
C50s-55sL	18L[18.9Q]	7.5L[7.9Q]	12L[12.6Q]	100L[26.4G]	20kg[44 lb]

Engine Coolant Recommendation

Use a mixture of 50% ethylene glycol permanent-type anti-freeze containing rust and corrosion inhibitor only.

Note: This mixture provides anti-freeze protection level of -37°C (-34°F), approximately.

Transmission Fluid Recommendation

Use CLARK Specification MS-276A CLARK Part number 2776236.

Hydraulic Fluid Recommendation

Use CLARK Specification MS-68 CLARK Part number 2776239 Hydraulic Oil, with anti-wear additives, or equivalent only.

Truck Weights

- with standard upright. [C40-50s : 3000mm, C55s : 2800mm MFH]

Gross Vehicle Weight(kg[lbs])	Empty Vehicle Weight (kg[lbs])	Loaded Drive Axle (kg[lbs])	Empty Drive Axle (kg[lbs])
-------------------------------	--------------------------------	-----------------------------	----------------------------

Pneumatic Diesel

C40	KUBOTA	9986[22015]	5986[13197]	8842[19493]	2641[5822]
	DEUTZ	10062[22187]	6062[13364]	8892[19603]	2675[5897]
C45	KUBOTA	11032[24321]	6532[14400]	9784[21570]	2807[6188]
	DEUTZ	11108[24489]	6608[14568]	9844[21702]	2840[6261]
C50s	KUBOTA	12129[26739]	7129[15717]	10798[23805]	3183[6918]
	DEUTZ	12205[26907]	7205[15884]	10848[23916]	3217[7092]
C55s	KUBOTA	13069[28812]	7569[16687]	11487[25324]	3112[6860]
	DEUTZ	13149[28988]	7645[16854]	11657[25699]	3143[6929]

Pneumatic LPG

C40	GM	9833[21678]	5833[12859]	8153[17974]	2548[5617]
	PSI 4X	9833[21678]	5833[12859]	8749[19288]	2548[5617]
C45	GM	10879[23984]	6379[14063]	9120[20106]	2714[5983]
	PSI 4X	10879[23984]	6379[14063]	9690[21363]	2714[5983]
C50s	GM	11977[26404]	6977[15381]	10110[22288]	3087[6805]
	PSI 4X	11977[26404]	6977[15381]	10701[23592]	3087[6805]
C55s	GM	12917[28477]	7417[16351]	10866[23955]	3014[6644]
	PSI 4X	12917[28477]	7417[16351]	11487[23325]	3112[6861]

C60-C80

CLARK products and specifications are subject to improvements and changes without notice or obligation.

Model Designation - Rated Load Capacity

C60	6000kg @600mm load center	[13200lbs @24in]
C70	7000kg @600mm load center	[15400lbs @24in]
C75	7500kg @600mm load center	[16500lbs @24in]
C80	8000kg @600mm load center	[17600lbs @24in]

Note: Rated capacity applies when using standard upright.
[C60-75 : 3000mm, C80 : 2800mm MFH]

Engine

	Diesel	Diesel	LPG	LPG	Diesel
Model :	IVECO F4GE9454C	DEUTZ TD3.6	GM V6	PSI 4X	DOOSAN D34P
Cylinders :	4	4	6	6	4
Displacement					
cubic inches :	274	219	262	262	208
liters :	4.5	3.6	4.3	4.3	3.4
Idle RPM :	750	850	700	700	850
Governed RPM					
High idle :	2480	2620	2600	2600	2600
Rated RPM :	2300	2300	2400	2400	2400
Rated kW :	67	55.4	75	82	81.9

Cooling System

Automotive type crossflow radiator.

Cooling system pressure (radiator cap): 88 kPa nominal, 12.8psi
Thermostat: Diesel & LPG, 82°C (180°F), fully open 95°C (203°F)

Powershift Transmission

- 3WG-116 Transmission (C60-80 Diesel, Old type)

Speed :	3 Forward / 3 Reverse		
Overall Ratios :	1st / 4.578:1		
	2nd / 2.396:1	3rd / 0.994:1	
Convertor Stall Ratio :	2.382 :1		

- 3WG-94EC Transmission (C60-80 Diesel, New type)

Speed :	3 Forward / 3 Reverse		
Overall Ratios :	1st / 4.446:1		
	2nd / 2.341:1	3rd / 0.974:1	
Convertor Stall Ratio :	2.529 :1		

- CLARK T12000 Transmission (C60-75 LPG)

Speed : 3 Forward / 3 Reverse
Overall Ratios : 1st / 5.02:1
 : 2nd / 2.56:1
 : 3rd / 1.00:1
Converter Stall Ratio : 2 :1

Drive Axle

Full floating straight drive axle. 4 pinion differential with wet disk brakes

Wheels and Tires

Drive C60-75 Dual : 8.25×15-14PR.....820kpa (119psi)
C80 Dual : 8.25×15-18PR.....1000kpa (145psi)

Steer C60-75 8.25×15-14PR.....820kpa (119psi)
C80 8.25×15-18PR.....1000kpa (145psi)

Standard Electrical System

Type: 24 volt DC, negative ground Fuses: 10, 15 amps

Batteries: BCI Group 45

Fuel Recommendations

Diesel: D-2 with cetane rating of 45 or higher.
D-1 and Jet A-1 also acceptable.

LPG: HD-5 propane

Fill Capacities *(fluid volumes-liters, quarts, gallons,kilogram,pound)*

	Cooling system	Eng.oil,w/ filter	Transmission	Hydraulic sump	Fuel tank
C60-75D	24L[25.2Q]	11L[11.5Q]	23L[24.2Q]	120L[31.7G]	160L[42.3G]
C80D	24L[25.2Q]	11L[11.5Q]	23L[24.2Q]	147L[38.9G]	200L[52.9G]
C60-75L	24L[25.2Q]	11L[11.5Q]	14.0L[14.8Q]	120L[31.7G]	20kg[44 lb]



Engine Coolant Recommendation

Use a mixture of 50% ethylene glycol permanent-type anti-freeze containing rust and corrosion inhibitor only.

Note: This mixture provides anti-freeze protection level of -37°C (-34°F), approximately.

Transmission Fluid Recommendation

Use CLARK Specification MS-276A CLARK Part number 2776236.

Hydraulic Fluid Recommendation

Use CLARK Specification MS-68 CLARK Part number 2776239 Hydraulic Oil, with anti-wear additives, or equivalent only.

Truck Weights

- with standard upright. [C60-75 : 3000mm, C80 : 2800mm MFH]

	Gross Vehicle Weight(kg[lbs])	Empty Vehicle Weight (kg[lbs])	Loaded Drive Axle (kg[lbs])	Empty Drive Axle (kg[lbs])
Pneumatic Diesel				
C60	15260[33642]	9260[20415]	13926[29313]	4050[8928]
C70	16630[36663]	9630[21230]	14717[32445]	3931[8666]
C75	17144[37796]	9644[21261]	15555[34292]	3998[8814]
C80	18360[40477]	10360[22840]	16186[35684]	4231[9327]
Pneumatic LPG				
C60	15029[33133]	9029[19906]	13221[29147]	3976[8766]
C70	16399[36154]	9399[20721]	14642[32280]	3856[8501]
C75	17042[37571]	9542[21037]	15471[34108]	3914[8629]

Engine Oil

Engine Oil Recommendation

LPG truck

GM, PSI 4X - in accordance with API classification SM grade and SAE 5W-30 full synthetic

Diesel truck

KUBOTA - in accordance with API classification CJ-4 with high sulfur fuel (CF with low-sulfur fuel) / SAE 15W-40

IVECO - in accordance with API classification CI-4 and ACEA E3 / SAE 15W-40

DEUTZ - in accordance with API classification CI-4 and ACEA E9,E7,E6 / SAE 10W-40

DOOSAN - in accordance with API classification CJ-4 and ACEA E9 / SAE 15W-40

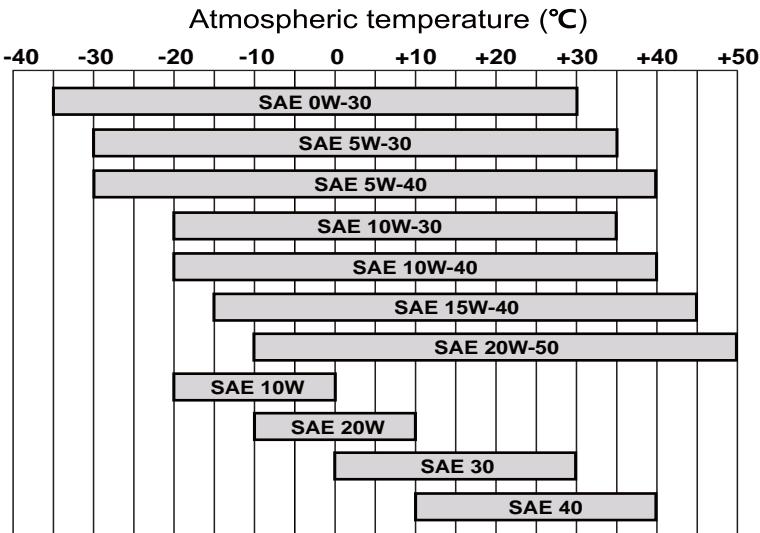

IMPORTANT

Do not extend oil change intervals from those specified when using synthetic lubricants.

Fill crankcase with correct amount of oil. When adding oil between oil changes, it is preferable to use the same brand as various oils may be incompatible. Refer to the Maintenance and Lubrication Section for recommended oil change intervals.

IMPORTANT

Do not overfill crankcase. Excess oil causes foaming and can cause loss of lubrication and higher operating temperatures, resulting in engine damage.

Index

A

- A Message to CLARK
- Lift Truck Operators ii
- Adjusting the Load Forks 4-10
- Adjusting the Seat 4-4
- After Operating the Truck 4-16
- Air Cleaning 7-26
- Attached position of safety decals 3-28
- Auxiliary Control Lever (Optional) 3-23
- Auxiliary Controls (Option) 7-19

B

- Battery 7-21
- Before Operating the Truck 4-2
- Brake Pedals 3-22
- Braking 4-6
- Buckling Up 4-4

C

- C40-55s 8-2
- C60-80 8-5
- Chain Slack 2-7
- Cold Start Preheating (Diesel Only) 3-20
- Concluding the Inspection 5-4
- Controlling Speed 4-6
- Cooling System 8-2
- Critical Fastener Torque Checks 7-27

D

- Daily Inspection 1-2
- Daily Safety Inspection 5-2
- Direction Control Lever 3-22
- Direction Control, Braking, and Inching 7-19

- Disassembling the split rim wheel 7-17
- Do's and Don'ts 1-3
- Drop-Offs 2-5

E

- Engine 8-2
- Engine Accessories 7-21
- Engine Air Cleaner 7-21
- Engine Coolant Recommendation 8-3
- Engine Cooling System 7-21
- Engine Oil 8-8
- Engine Oil and Filter 7-23
- Engine Stop 3-21
- Extreme Operation 7-9

F

- Fill Capacities 8-3
- Fluids, Filters, and Engine Accessories 7-20
- Fork Safety 1-8
- Forks 7-15
- Fuel Recommendations 8-3
- Fuel Safety Practices 5-5
- Functional Checks 5-4
- Functional Tests 7-17

G

- General Tire Maintenance, Inspection, and Repair 1-16
- Grades, Ramps, Slopes, and Inclines 1-11

H	
Hood open	3-24
Horn	7-17
Horn Button	3-22
Hot Surface Warning Decal ...	3-27
Hour Meter	3-21
Hour Meter	7-17
How to Perform Planned Maintenance	7-14
How to Tow a Disabled Truck ..	6-2
How to Use Battery Jumper Cables	6-4
How to Use this Manual	viii
Hydraulic Control Levers	3-23
Hydraulic Fluid and Filter Change	7-24
Hydraulic Sump Tank	7-24
I	
Indicator Lights	7-18
Instrument Pod	3-4
Introduction	vi
Introduction	7-2
K	
Keep Away from Forks Decal	3-27
Key/Start Switch	3-20
L	
Lateral Tip-over	1-13
Lift Chain Inspection and Measurement	7-28
Lift Chain Lubrication	7-28
Lift Chain Maintenance	7-27
Lift Chains	7-26
Lift Control Function	3-23
Lift Mechanisms and Controls	7-18
Load Handling	4-11
Load Handling Components ...	7-14
Long and Wide Loads / Rear Swing	2-3
Longitudinal Tip-over	1-13
Loose Loads	2-2
Low Overhead Clearance Fast Turns and High Loads	2-4
Lubrication	7-25
Lift Chain wear and Replacement Criteriai	7-28
M	
Major Component Locations	7-8
N	
Neutral Start Switch	7-17
No Riders	1-5
Normal Operation	7-9
O	
Operating Safely	4-7
Operator Compartment	3-3
Operator Daily Inspection	vii
Operator Protection	1-7
Operator Safety Warning Decal	3-26
Operator/Tip-Over	3-26
Overhead Guard	7-14
Operator Controls	3-20
P	
Pallets and Skids	2-8
Parking	1-15
Parking Brake	7-18
Parking Brake	3-21
Pedestrians	1-6
Picking Up and Moving Loads	4-13
Pinch Points	1-9
Planned Maintenance	vii

Planned Maintenance Intervals	7-9
PM Report Form	7-12
Pod Symbols and Functions	3-5
Positioning Forks and Upright .	4-5
Powershift Transmission	8-2
R	
Refueling Gasoline and Diesel Trucks	5-5
Refueling LPG Tanks	5-6
Right-Angle Stacking	2-6
Right-Angle Stacking	2-6
Routine Servicing and Maintenance	vi
S	
Safe Maintenance Practices	7-3
Safety Signs and Safety Messages	x
Seat Adjustment	3-21
Seat Belts	1-4
Service Brakes and Inching Pedal	7-18
Stacking	4-14
Starting from a Safe Condition	4-3
Starting the Truck	4-4
Steering Column Pylon	3-24
Steering System	3-22
Severe Operation	7-9
Steering System	7-19
Sump Tank Breather Maintenance and Inspection	7-25
Surface and Capacity	1-12
T	
Tilt Control Lever	3-23
Tip-Over	1-13
Traction Disable Fuction	3-22
Transaxle Fluid Check	7-25
Travel	1-10
Traveling with a Load	4-12
Truck Chassis Inspection and Lubrication	7-25
Truck Data and Capacity Plate	3-25
Truck Description	3-2
Truck Weights	8-4
U	
Unitrol Pedal	3-24
Unloading	4-13
Upright and Tilt Cylinder Lubrication	7-26
Upright Warning Decal	3-27
Urea(SCR) System (C60-80D, Doosan Engine)	3-12
V	
Visual Checks	5-3
Visual Inspection	7-14
W	
What to do in Case of a Tip-over	1-14
Wheels and Tires	8-3
Wheels and Tires	7-16



Additional copies of this manual may be purchased from
YOUR AUTHORIZED CLARK DEALER

CLARK MATERIAL HANDLING COMPANY

700 Enterprise Drive • Lexington, Kentucky 40510 [www.clarkmhc.com]

Printed Date ; Aug. 2021