

# CESAB R200 1.2 - 1.6 tonne

Reach trucks

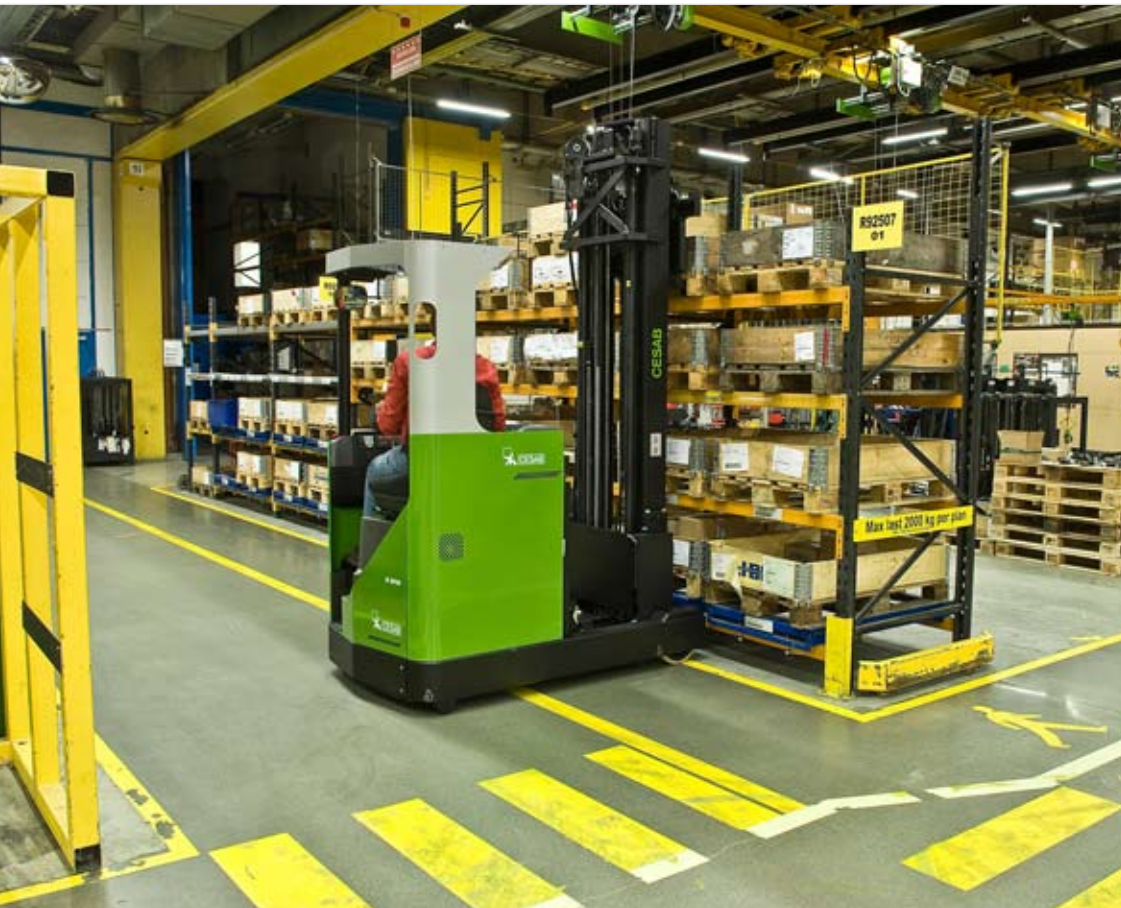

**PRODUCT GUIDE**



***This product guide applies to:***

<b>Model</b>
R212
R214
R216

***Document revision history:***

<b>Edition date</b>	<b>Changes</b>
January 2011	New generation Reach trucks

# Contents

<b>Product range information</b>	<b>5</b>
General .....	5
<b>Applications</b>	<b>6</b>
<b>Sales arguments</b>	<b>7</b>
Features and benefits .....	7
Important sales arguments for R200 .....	15
<b>Product details</b>	<b>17</b>
Main components and controls .....	17
Emergency switch .....	18
Keypad .....	18
Display .....	19
Operating console .....	21
Overhead guard panel .....	23
Operator's seat .....	24
Pedals.....	25
Accessories bar .....	26
Storage compartments .....	26
<b>Technical information</b>	<b>27</b>
Capacity information .....	27
Aisle width requirements .....	28

Calculation of aisle width requirements .....	28
Floor requirements.....	29
Batteries and chargers .....	29
<b>Options</b>	<b>31</b>
Load support .....	31
Extension forks .....	31
Lift height limiter .....	31
Height indicator and height pre-selection .....	32
Side shifting .....	32
Fork tilt angle +4°/-0,5° .....	33
Warning light .....	33
Writing table .....	33
Rear-view mirror .....	34
Foot-operated travel direction switch .....	34
Operator's seat .....	35
Operator protection .....	35
Overhead guard for drive-in racking .....	36
Battery replacement equipment – Roller bed .....	36
Battery change table/trolley .....	36
<b>Appendix</b>	<b>37</b>
Parameter setting .....	37
Programming/deletion of height preselection .....	38
Using height preselection .....	39

# Product range information

## General

The R200 series completes the lower capacity range with capacity segments made up by the R212 (1200 kg), R214 (1400 kg) and R216 (1600 kg). In the right application, combining AC technology for driving with DC technology for lifting results in optimum machine performance.

These are the main characteristics of the R200 Series:

- 360° progressive, electronic steering
- electronic control of hydraulic movement
- possibility to both accelerate and retard (brake) with the same pedal
- perfect vision in all directions
- electronic, regenerative brake system
- Automatic parking brake



# Applications

Typical application involves universal material handling at smaller sites. The truck can be used for cargo handling in large warehouses and racking, floor stacking and transport.

Typical customers are made up by small and medium size companies with a varying number of pallets handled each day. These customers can be found in most industries, from wholesalers and retailers to small manufacturers and haulage contractors.



# Sales arguments

## Features and benefits

### *Operator compartment*

The operator compartment should be ergonomically designed since this is where the operator spends most of the day. A tired operator is less productive.

- Low in-step height of only 270 mm
- The black upright has an easy-to-grip surface for fast, safe entry to the truck.
- Seat with ergonomic design
- Adjustable forward/backward and backrest angle
- Storage compartments for documents, pens, knives, cans, gloves, etc.
- Armrest positioned and designed to provide comfortable support
- Insulated battery wall to reduce the effects of variations in temperature during work
- Protected operator environment. The operator is always inside the truck profile
- Large overhead guard that protects the entire operator compartment
- Excellent view through the overhead guard
- Headrest on the rear up-right protects the operator's head and neck against shocks and bumps
- Plexiglas protection prevents touching of mast



### **Free-view mast**

- The mast width allows excellent visibility from the operator's position
- High lifting and lowering speeds
- Dampened movement of fork carrier when switching from free lift to main lift, and vice versa
- Soft stopping for all lifts
- Fast reach operation that can be adjusted to suit any handling situation
- Crawl speed when the reach carriage approaches the end positions
- All hydraulic functions have automatic cushioning:
  - Lifting/lowering: Gentle stopping when the lever is released. This minimises jerking movement in the fork carriage as a result of the high speed
  - Reach extension: Gentle stopping to reduce the risk of mast sway
  - Side shifting: Gentle starting and stopping
- Mast chains with fivefold safety implementation assure the highest level of safety both for the operator and the handled load.





### **Fork tilting**

- Available on R214 and R216
- No mast sway just like mast tilting
- Minimum transfer of the centre of gravity
- Reduced capacity because of the lifting height can be minimised
- Quick tilting speed independent of the lifting height
- Maintained tilting angle no matter what the lifting height

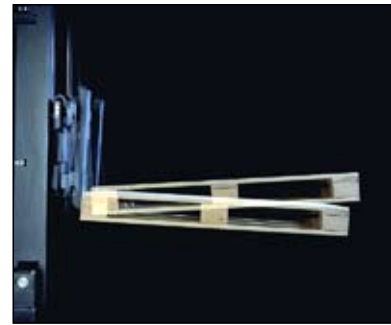

### **Extra hydraulic functions**

- Available on R214 and R216
  - The oil flow can be easily adjusted using the 4th and 5th function
  - 4th and 5th functions operated via separate levers
- Integrated side shifting as option
  - More narrow aisle width
  - Improved capacity
  - Improved visibility when side shifting
- Integrated hoses as option

Three hoses are integrated in the mast: Two for the oil supply and one for electric cables. Designed and placed for maximum visibility.

## **Driving**

- Fully electronic steering simplifies manoeuvrability.
- Small steering wheel requiring only small hand and arm movements and minimum effort.
- 360° progressive steering for fast and safe operation
- Progressive steering requires less turning at low speed and more turning at high speed to assure safe, comfortable driving.
- Wrist support next to steering wheel
- Travel direction selector with ergonomic design and optimum position close to the hydraulic levers.
- Possibility to travel at creep speed without depressing the accelerator pedal for smooth, precise positioning.
- Pedal arrangement similar to a passenger car for short reaction times.
- The safety pedal prevents the operator from keeping his foot outside the truck while driving. An audible buzzer or audible buzzer together with braking of the truck (standard setting) if the pedal is not kept depressed while driving.

## **Braking**

- Progressive automatic braking by releasing the accelerator pedal
- Braking when changing the travel direction
- Programmable power
- Regenerating
  - Up to 7–8% of total power consumption (12–15% of the energy when travelling) is recovered to the battery
- Parking brake integrated in brake pedal
- The parking brake is released using the accelerator pedal
- Electrical pedal brake system
  - No brake shoes
  - No adjustment necessary
  - No hydraulic connections
  - No wear results in lower maintenance costs
- Automatic braking if
  - Truck is switched off
  - The operator leaves the operator's seat, with 2-3 seconds delay
- Automatic safety braking if an error should occur

### **Parameter settings**

Steering response can be set to one of six levels for smooth, safe handling. The progressive steering can be switched on or off to suit individual needs.

Programmable acceleration, top speed and braking power as a percentage of maximum. Ideal when training new operators and for handling unstable and fragile loads. Choice of hour meter displays to suit individual needs.

### **Controls and functions**

Display with indicator lamps shows truck status. Important to reach full utilisation of the truck.

When the truck is switched on, it performs a diagnostic test and quickly reports whether everything is in order.



Multitasking ability allows several tasks to be performed simultaneously in order to increase productivity.

All controls are fully electronic for greater freedom in parameter setting. This reduces the noise level, wear, and service and maintenance needs and promotes quick, precise load handling.

### **Support arms**

Support arm dimensions: 880 mm inside/1120 mm outside.

#### **Wear stripes**

The support arms are fitted with replaceable wear stripes.

#### **Support arm wheels**

Protection around the wheels results in lower maintenance cost.

#### **Reach carriage**

Four rollers, protected against dirt and impacts, are placed inside the support arms.



#### **The reach function is protected by a pressure relief valve**

Operates as a shock absorber to prevent damage to the reach cylinder, its fixings or the reach carriage if the forks suddenly collide with something.

## **Battery**

Select between three different battery sizes. This allows adapting the truck to the work tasks depending on whether it is used for short or long shifts.

### **Wide battery**

Uses the full width of the truck for improved stability and reduced aisle width requirement.

### **Location on the support arms**

To achieve maximum stability, the battery is always in a fixed position during operation.

### **Battery inspection and maintenance**

Easy access to the battery by using the reach carriage.

### **Battery charging**

An easy to reach DIN connector is placed on top of the battery.

### **Battery replacement, roller bed (option)**

Using an optional roller bed, battery replacement is quick and easy. The roller bed can be pulled out by the reach carrier.

*NOTE! Not standard battery container.*

## **Service, maintenance and technical features**

### **2-year factory warranty or 3000 operating hours**

2-year warranty on the drive and lift motors, gear box, logic cards and pump controller. For more information, please refer to the warranty conditions.

### **Easy checking**

All operating functions can be checked whilst seated in the cab.

### **Logic card**

Features indicator LEDs for simplified verification. Fast and accurate information to the service technician.

### **Error codes with interruption function**

If a fault occurs on a component that is vital to truck operation, the truck will be partly or entirely switched off.

Example: Defective connections in the hydraulics will switch off the hydraulic function, while a fault in the steering system will cause the complete truck to be switched off. Error codes immediately displays the fault. Fast and accurate information to the service technician.

### **Caution codes with warning function**

Cautions codes warn the operator that something abnormal has occurred. The code shows what is wrong, however, it is still possible to operate the truck.

Example: No connection with hydraulic levers. Immediate information about what has occurred. Fast and accurate information to the service technician.

### **The last 50 error codes are recorded and time stamped**

The codes can be shown on the display without any need for a separate monitor.

### **Availability**

Motor cover can be fully opened: Quick and full access to the motor and oil tank. No tools required. Large components, such as the drive and lift motors, can be easily lifted out. All electronic modules are housed in a separate compartment, located under the armrest panel.

Environment protected against oil, dirt and battery fumes.

Removable panels. Quick and full access to the pedals, brake cylinder, electronics, etc.

Drive wheel easy to reach behind a removable cover. Bolted and easy to replace.



### **Drive motor without commutator and brushes**

Simplified design with improved reliability of motor. No wear. Fewer consumable parts.

### **Temperature warning in both motors and their controllers**

No overheating.

### **Only one contactor**

No contactor for forwards/backwards travel. No contactor for lifting. Fewer consumable parts.

### **Service timer**

Tells when it is time for next service.

### **Emergency driving when steering not working**

Release the parking brake using the switch under the arm rest panel. The truck can be steered mechanically via a column that is inserted through a hole in the motor hood and engaged with the steering motor.

### **Emergency moving of the truck when driving is not working**

Release the parking brake using the switch under the arm rest panel. The truck can then be towed without lifting it.

### **Emergency lowering of the forks**

Via a switch under the armrest panel.

### **Emergency retraction of the mast**

Via a switch under the armrest panel.

### **Digital CAN (Controller Area Network) communication between the logic card and the controllers**

More information is transferred in shorter time. Accurate information transfer. Easier and faster check of the various truck functions. Immunity against radio signal interference, etc. Reduced cabling. Future development possibilities.

### **MOSFET components**

Higher quality. Lower losses. Higher reliability. Lower cost.



## Important sales arguments for R200

### **Operator environment**

- Space
- Low entry
- Ergonomic design with, among others, adjustment of the operator's seat, operating console, levers and pedals
- Pedals arranged similarly to a passenger car
- Small steering wheel and lever movements that require minimum effort reduce the strain on the operator.



### **Controls**

- Fingertip operation
- From left to right
  - 1: Lift/lowering of forks, quick and smooth
  - 2: Mast extension
  - 3: Tilting
  - 4 and 5: Extra hydraulic functions
- Travel direction selector
- Horn button
- Progressive electronic steering, 360°
- Digital display
- Keypad for programming of parameters and entry of PIN codes
- Emergency switch



### **View and safety**

The operator is always inside the truck profile

- Strong overhead guard
- Plexiglas protection between the hydraulic levers and the mast
- Free view around the truck and upwards
  - through and next to the mast
  - through the overhead guard
  - to the rear through the opening in the side post

### ***Mast***

- Fork tilting (R214, R216 )
- Protected lifting rams

### ***Battery***

- Easy access

### ***Easy to service***

(Open the hood under the operator's seat

- Steering motor
- Travel drive motor
- Lift motor
- Hydraulic oil tank

### ***Battery connector and charging***

- Battery connector position
- DIN-type battery connector

### ***Miscellaneous***

- Programmable parameters
- CAN bus technology (CAN = Controller Area Network)
- Microcomputer control
- Drive motor with AC operation

### ***Operation***

- 360° steering



# Product details

## Main components and controls

1. Emergency switch
2. Keypad
3. Display
4. Switches and indicators
5. Operating console
6. Knob for adjusting the operating console position
7. Overhead guard panel with height indicator, radio and speakers.
8. Operator's seat
9. Pedals
10. Accessories bar

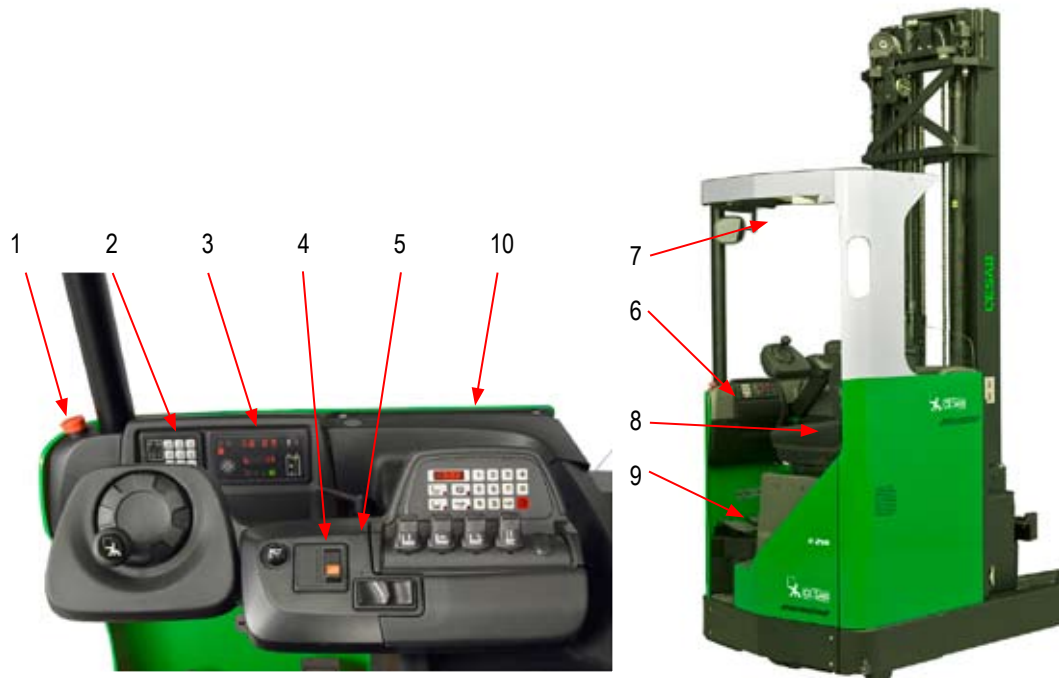

## Emergency switch

The emergency switch is placed on the instrument panel where it can be reached from both outside and inside the truck cab. If activated, the truck can still be steered. Following activation of the emergency switch, the truck must be restarted to reset the switch.



## Keypad

The truck is started by using the keypad on the instrument panel. Select code 1, 2 or 3 and then depress the green key (I).



Upon request, a service technician can program the truck to enable a 4-digit PIN code.

Up to 100 different 4-digit codes can be programmed. These control access to the truck. Additionally, it is possible to associate a maximum of 10 different operator profiles to the PIN codes.

Upon delivery, all operator profiles are the same.

The truck can be switched off by pressing the red key  on the keypad. If the truck is left switched on and is not operated, it can be automatically switched off after a desired time interval. This feature is preset to approx. 20 minutes

## ***Operator identification and operator parameters***

The operator must log in to start the truck. This way, unauthorised persons can be prevented from starting the truck. Additionally, the truck can be adapted to different operator preferences, such as max. travel speed, max. acceleration, steering response, etc.

The parameter settings can be locked and access permitted only via a special service key. In this case, the management at the work place must decide whether the parameter settings should be accessible. This way, damage to the truck by unauthorised persons can be avoided.

The following parameters can be changed by the operator: Steering response, maximum speed, acceleration, motor braking, braking force when changing the direction of travel.

## Display

The truck has an easy-to-read display with red and green truck status LEDs.

### **Parking brake indicator (A)**

The brake is automatically applied when the operator leaves the seat. The symbol “P” lights up in the display window (A).

### **Direction indicator (B)**

The arrows indicate the selected travel direction.

### **Time display (C)**

Shows current time. The clock also records and stores the time together with an error code if a fault should occur.

### **Hour meter/error code display (D)**

This display window shows the time, the weight of the load and any error codes. The display symbol (J) lights as long as the hour meter is displayed.

The display symbol (G) lights when a warning or error code is displayed. An E (Error) or C (Caution) is displayed in the left part of the display together with the error code on the right. Error codes are described in the operating instructions.

### **Operator identification (E)**

When an operator’s profile is selected, the corresponding number is displayed here. See the previous page.

### **Drive wheel indicator (F)**

Shows the drive wheel position

### **Warning/error code indication (G)**

This symbol lights in connection with warning/error codes.

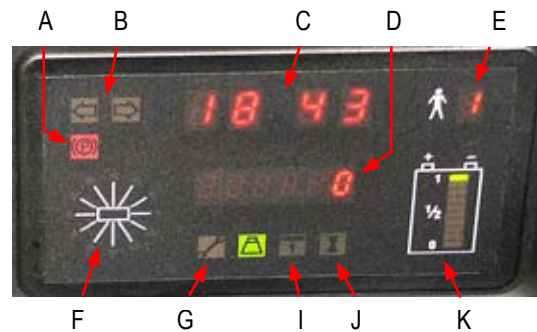

### ***Parameter indicator (I)***

This display symbol lights when verifying the set parameters.

### ***Hour meter indicator (J)***

This display symbol lights when the hour meter is shown. Operating hours can be displayed in several different ways:

**Key time:** Measures the total time the truck has remained switched on using the keypad.

**Total operating hours:** measures the total hours the truck has remained switched on, i.e. when a drive or lift function has been active.

**Drive motor time:** measures the total time the drive motor has been operating.

**Lift motor time:** measures the total time the lift motor has been operating.

**Service time:** calculates the time remaining until next service and signals when the truck should be serviced.

### ***Battery indicator (K)***

The battery indicator checks both voltage and current. The battery indicator uses a 10-segment scale to show the battery charge. As the battery is discharged, the segments change colour from green to yellow, and finally red.

A red LED starts blinking when only 30% of the battery capacity remains.

When 20% battery capacity remains, the lift function is disabled. However the truck can still lower the forks and drive.

## Operating console

### Steering wheel

The steering characteristics are progressive. This means the higher the travel speed, the lower the steering response (sensitivity is reduced). When driving slowly, the steering wheel need not be turned as many turns as when driving at high speed.

The steering characteristics can be adapted to the operator's experience and preferences. Steering sensitivity and progressiveness can be increased or decreased as required.



The drive wheel has no end limit position, which allows steering through 360°.

When driving slowly and turning the truck, the wheel can be turned quicker using the spinner (B).

When driving at high speed (long distance transports, etc.), it is easiest to steer the truck by holding the fingertips on the steering hub (C).

### Hydraulic controls

The operating console has a maximum of five mini levers used to operate all hydraulic functions. Hydraulic operation speed can be adjusted depending on how much the levers are moved forwards or backwards.

Functions:

Lever 1 – Lift/Lower forks

Lever 2 – Reach carriage out/in

Lever 3 – Fork tilt down/up

Lever 4 – Function 4

Lever 5 – Function 5



Levers 4 – 5 can be programmed with other functions, i.e. side shifting and a clamping unit.

Fork lowering can be used simultaneously together with another hydraulic function.

The fork lifting takes priority over other functions when activated at the same time. Contact an authorised CESAB service technician if this priority needs to be changed.

The lever distance can be adjusted to suit the accompanying cover plates.

**Note:** *The hydraulic functions cannot be operated if the truck has been switched off or if the operator is not sitting in the operator's seat.*

### **Travel direction selector**

The travel direction selector is located on the operating console. This way, it is easy to use because it is within easy reach from the hydraulic levers. It can also be used when the operator uses the hydraulic functions and is looking at something above. Select the travel direction by pressing the switch corresponding to the desired direction of travel. The selected travel direction is displayed on the instrument panel. The travel direction selector also has another important function. If the switch is kept depressed for approx. 1.5 second (applies to both travel directions), the truck will enter the creep speed mode. The truck stops as soon as the switch is released. This can be used when it is necessary to “inch” forwards to the racking, e.g. when handling fragile loads.



Optionally, the travel direction selector can be ordered in a pedal design with two switches.

### **Knob for adjusting the operating console position**

The operating console can be continuously adjusted for the most comfortable operator position.

- Loosen the knob (A) and then adjust the operating console to the desired height.
- Undo the knob (B) and then adjust the operating console to the desired angle.
- Remember to lock both knobs (A) and (B) following adjustment. The lock knobs can be locked in different positions by first lifting the knob, then turning and pushing it down again.
- Move the lock knob (C) to the rearmost position. The operating console can now be move forwards/backwards around its pivoting point. Lock the operating console by moving the lock knob to the front again.

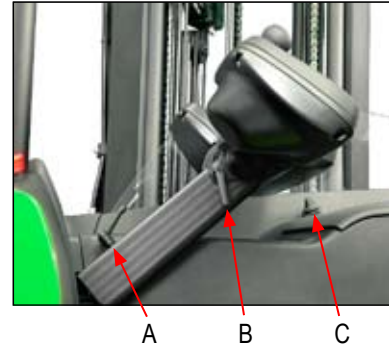

## **Overhead guard panel**

### **Height indicator**

*(Standard on R216 with lift height  $\geq$  6300 mm)*

A height indicator is integrated in the overhead guard panel in front of the operator. It displays the fork height in the main lift range in centimetres. This is an excellent aid, which can be used separately or in combination with a height preselection level. Instead of concentrating on the fork position, the operator can use the display indication for quick fork positioning and then switch his attention to the forks once the approximate lift height has been reached.

### **Radio/CD player**

The overhead guard panel can also hold a radio/CD player. Two speakers are installed in a mounting cassette under the overhead guard for stereo sound reproduction.

## Operator's seat

The operator's seat has an ergonomic design. It has an optimally shaped seatback and side supports. The seat cushion has a unique design for maximum ergonomics. The operator's seat can be adjusted forwards/backwards as required to attain the most comfortable operating position. The seat-back angle is also adjustable.

- Lift up the lever (A) while sliding the seat forwards/backwards to adjust the seat back angle.
- Pull out the lever (B) to release the catch and then adjust the forward/backward position of the seat.



The seat's spring pressure can be adjusted according to the operator's weight.

- Set the seat's spring pressure with the lever (C). Perform this setting with an empty seat. Pull out the lever until the indicated weight corresponds to that of the operator. To reset, pull out the lever fully and allow it to return. Use the scale as a reference when adjusting the spring pressure.



## Pedals

### **Safety pedal (A)**

The left foot must be kept on the safety pedal when the parking brake is released. This prevents the foot from being caught if the truck collides with an obstacle.

Two optional functions can be controlled by the safety pedal:

- a buzzer sounds, or
- a buzzer sounds and acceleration stops when the pedal is not held down with the left foot. Motor braking and the foot brake can be used however.

To change the function, please contact a service technician

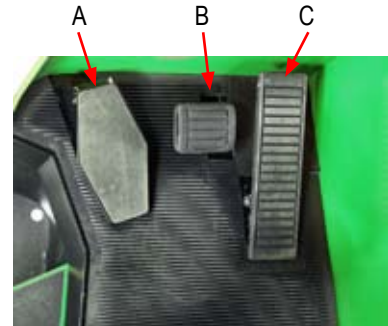

### **Service brake (B)**

If the truck has stopped and the travel brake pedal is pressed down, the parking brake is automatically applied.

### **Accelerator pedal (C)**

When depressing the accelerator pedal, the parking brake is automatically released. The truck has been programmed for automatic braking when the accelerator pedal is released. The braking force is programmable. Additionally, this function is progressive, i.e. the faster the accelerator pedal is released, the higher the braking power.

### **Safety pedal with travel direction selector (special)**

If the truck features travel direction selection tied to the safety pedal, selection is performed using the two switches on the safety pedal.

## Accessories bar

All models feature an integrated accessories bar that can accommodate a computer terminal, a PC, scanner or other electronic equipment required on board the truck. Also, optional voltage converters and adapters are available to facilitate installation of such equipment.



## Storage compartments

The truck has several convenient compartments for things the operator needs in his work, such as documents, pens, knives, cans, gloves, etc.



## Display and programming

It is possible to view the machine-specific registers, but not to reprogram the settings. It is however possible to program operator-specific parameters and to set the clock. Please refer to Appendix A for more information on programming the operator parameters. For more information on warning and error codes, please refer to the operating instructions.

# Technical information

## Capacity information

Model	R212			R214			R216		
Width between support arms (mm)	880	880	880	880	880	880	880	880	880
Battery (Ah)	292-300	360-450	480-600	292-300	360-450	480-600	292-300	360-450	480-600
Battery depth (mm)	275	340	430	275	340	430	275	340	430
Max. capacity (kg)/lifting height (mm)	1200/3600	1200/3900	1200/4500	1400/3400	1400/4100	1400/4900	1600/3700	1600/4000	1600/5000
Lifting height (mm)	Lifting capacity in kg with 600 mm load centre								
3350	1200	1200	1200	-	-	-	-	-	-
3750	1175	1200	1200	-	-	-	-	-	-
4150	1125	1150	1200	-	-	-	-	-	-
4400	-	-	-	1250	1350	1400	1480	1530	1600
4500	1075	1100	1200	-	-	-	-	-	-
4800	1025	1050	1125	1200	1300	1400	1415	1475	1600
5400	800	900	1000	1125	1225	1325	1315	1380	1530
5700	-	-	-	1075	1200	1275	1265	1335	1480
6000	500	600	700	-	-	-	-	-	-
6300	-	-	-	750	1050	1200	1165	1240	1375
6750	-	-	-	-	-	-	1090	1170	1300
7000	-	-	-	-	-	-	1050	1130	1255
7500	-	-	-	-	-	-	965	1055	1170
8000	-	-	-	-	-	-	880	975	1085
8500	-	-	-	-	-	-	800	900	1000

The R200 series trucks feature studs under the chassis. The studs are close to the surface (15 mm), which implies that they may hit against obstructions during normal operation. If they present an obstruction (on models R212 and R214), they can be disassembled without affecting the truck capacity.

**NOTE!** Do not disassemble the studs on model R216 for any reason whatsoever.

# Aisle width requirements

Model	EUR pallet 800 x 1200 mm	Standard VDI	
	Type of handling	With side shifting	Without side shifting
	Aisle width requirement, mm		
R212 <sup>1)</sup>	Short side	2755	2700
	Long side	2599	2544
R212 <sup>2)</sup>	Short side	2813	2758
	Long side	2634	2579
R212 <sup>3)</sup>	Short side	2894	2839
	Long side	2689	2634
R214 <sup>1)</sup>	Short side	2765	2727
	Long side	2598	2560
R214 <sup>2)</sup>	Short side	2824	2786
	Long side	2635	2597
R214 <sup>3)</sup>	Short side	2906	2868
	Long side	2692	2654
R216 <sup>1)</sup>	Short side	2778	2743
	Long side	2592	2570
R216 <sup>2)</sup>	Short side	2837	2802
	Long side	2632	2608
R216 <sup>3)</sup>	Short side	2920	2884
	Long side	2693	2666

1) = 300 Ah, 2) = 450 Ah, 3) = 600 Ah battery

## Calculation of aisle width requirements

### VDI 2198 standard

$$R1^2 = (L-x)^2 + B^2$$

$$R1 = \sqrt{(L-x)^2 + B^2}$$

$$A = Wa + R1 + (2 \times 100)$$

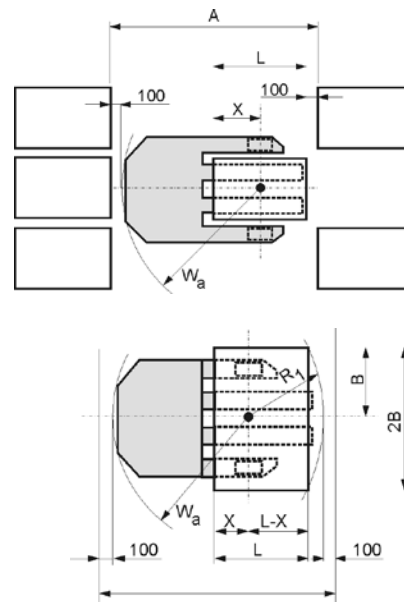

## Floor requirements

There are no special floor requirements for reach trucks, except the floors must be perfectly level. This is especially important when lifting to high heights, since the mast remain vertical even when extended to the maximum lift height.

Additionally, the floor must be able to hold the weight of the truck and the wheel pressure when fully loaded. The racking company will have information about the weight and ground pressure of the racking.

The table below shows the axle pressure for the R200 trucks. Pressures are given for machines with standard specifications and without operator. Higher lift heights and add-on equipment will increase the axle pressure. Please note that this is the static pressure. To obtain dynamic pressure, i.e. when driving at full speed, multiply the figures in the table with 1.4.

Model	Rated load, kg	Maximum axle pressure kg	
		Drive wheel	Support arm wheels
R212	0	1630	1430
	1200	1340	3330
R214	0	1690	1640
	1400	1300	3930
R216	0	2003	2118
	1600	1580	4685

## Batteries and chargers

### *Choosing the correct battery*

A number of different factors affect the choice of battery. Physical limitations include the size of the battery compartment and the minimum and maximum battery weights allowed by the truck design.

The use of the truck also affects the battery choice. For short shifts, a smaller battery should be chosen and, reversely, for longer shifts larger battery capacity is required.



If a low-capacity battery is used for extended longer operation, the battery will discharge quickly. On the other hand, a high-capacity battery used for short work shifts, will cause increased battery wear due to frequent charging of a battery that is not fully discharged.

## Weight and capacity

### Battery table, R200

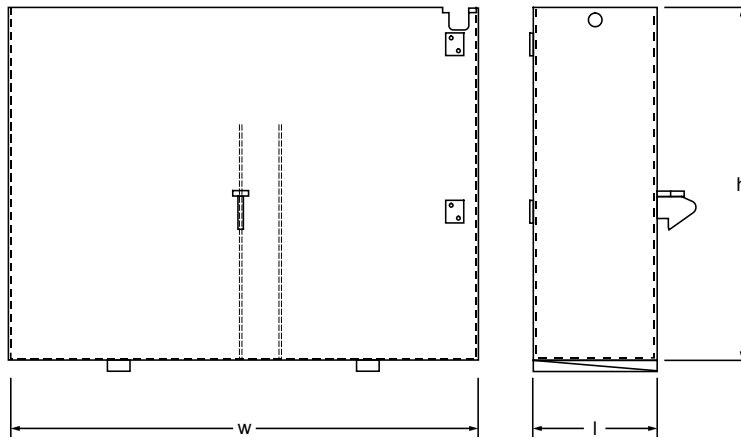

Model	Power (Ah)	Power (kWh)	Min. weight (kg)	Width, w (mm)	Depth, l (mm)	Height, h (mm)	
						w/o roller bed <sup>1)</sup>	w roller bed
All	300	14.4	510	1040	275	778	783
All	360–450	17.3–21.6	610	1040	340	778	783
All	480–600	23–28.8	780	1040	430	778	783

1) Height not including the keys (25 mm) underneath the battery

Please note that the battery compartment differs depending on whether or not a roller bed is used. Without a roller bed, the battery has keys underneath to guide it to the right position in the battery compartment. With a roller bed, the battery is flat underneath (although reinforced) to enable it to roll on/off the roller bed. In this case, the keys for guiding are positioned underneath the roller bed.

### Charger selection

An automatic charger provides the best charging conditions for the battery and extends the battery service life. The charging current of the charger should be as follows.

Battery (Ah)	Battery (kWh)	Charger (A)
300–480	14.4–23	50–70

# Options

## Load support

The load support increases the stability of the load when handling high loads. It also reduces the risk of goods falling from the forks onto the operator.

The standard height is 1000 mm, but 750, 850, 900, 950 mm and 1100–1600 mm in increments of 100 mm can be ordered. The indicated height is from the upper side of the fork blade to the top of the support itself. The width is 900 mm.

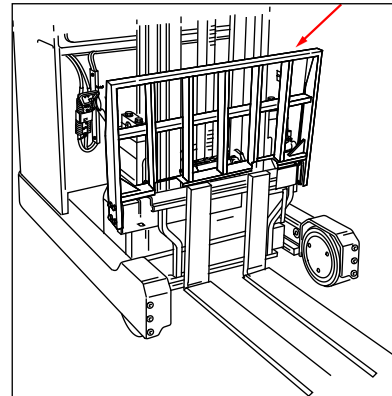

## Extension forks

The extension forks fit on top of the standard forks and allow transport of longer goods than is possible with the standard forks.

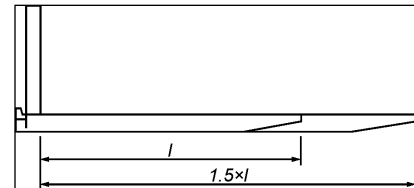

## Height indicator and height pre-selection

The height indicator provides information about the current fork height. (Standard on the R216 for lift heights from 6.3 metres. Option for lower lift heights.)

The current height is shown on the display, ergonomically placed immediately below the overhead guard.

Height preselection allows quick, easy and exact height positioning of the forks.

The height can be programmed using the keypad position next to the hydraulic levers. Once height levels have been programmed (max. 99 levels), the forks can be lifted to the exact height level by entering a code and operating the lifting lever. The forks automatically stop at the correct level for quick and safe handling of the load.



**Available on: R214 and R216**

## Side shifting

Side shifting allows lateral positioning of the forks. Using the standard side shift, the forks can be moved between the support arms without hitting the support arms.

Four hydraulic functions are needed.

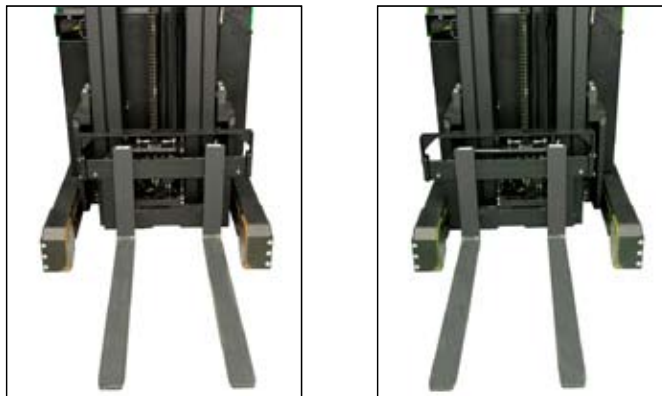

For R200	Movement (mm)	Total width of lower post (mm)	Total width of lower post during side shifting (mm)	Distance between the forks' centre (mm)	Type of side shift <sup>1)</sup>
R212	+/-55	600	710	160-360	Hooked on
R214, R216	+/-75	700	850	In increments of 50	Integrated

1) The aisle should be widened



## Fork tilt angle $+4^{\circ}/-0,5^{\circ}$

$4^{\circ}/-2^{\circ}$  is standard. A tilt angle of  $+4^{\circ}/-0.5^{\circ}$  means that when the forks are tilted in the lowered position, the forks are more or less horizontal. This minimises the need for a tilt indicator.

*Available on: R214 and R216*

## Warning light

A warning light can be mounted on the truck to warn persons in close proximity when the truck is travelling.



## Work light

The work lights are used to illuminate dark areas. The light is turned on using the switches on the instrument panel.



## Writing table

Writing table for A4-size paper sheets.



## Rear-view mirror

Increases the visibility around the truck.



## Foot-operated travel direction switch

A travel direction switch is integrated in the accelerator pedal. Forward or reverse travel is selected by depressing the appropriate side of the accelerator pedal.



## Operator's seat

The operator's seat is available in various designs, e.g. with a textile cover with a low or high backrest. To suit different operating environments, the operator's seat with high backrest is available with seat heating and textile or leather imitation cover.



## Seat belt

To improve safety, the operator's seat can be fitted with a seat belt.

## Operator protection

Extra protection for the operator in the form of net/Plexiglas can be mounted on the overhead guard. This prevents small loads falling down on the operator.

Full-cover finger protection on the mast can also be mounted to prevent the operator coming into contact with the mast.

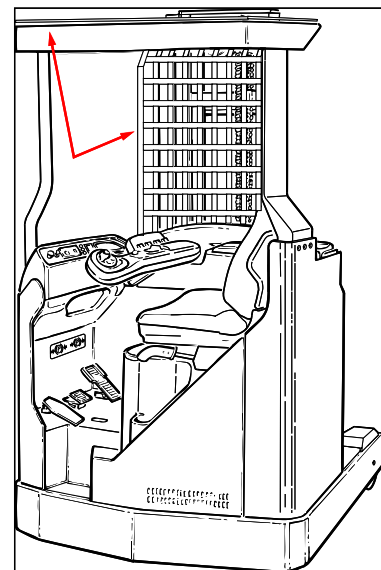

## Overhead guard for drive-in racking

An additional protection for small falling objects to protect the driver on top of the overhead guard when drive in rack.



## Battery replacement equipment – Roller bed

A roller bed can be installed on all R200. The battery rests on the support arms, not the rollers, during operation. The battery can be rolled out on to the roller bed in the usual way. Once the roller bed has been extended, the battery can be rolled to the left or right, and the charged battery can be fitted into the truck from the other side. Roller beds are available for all R200 battery sizes.

This option can be mounted in the field, however, it requires replacement of the cotters on the reach carriage.

**Note:** A special battery container with a flat base is required to enable the rollers to operate correctly. The container also has a special locking device. The total truck length increases by 25 mm, while the weight also increases. This affects the aisle width.

## Battery change table/trolley

Battery change table with two roller beds, one for the newly charged battery and one for the discharged battery

The roller bed can be adjusted to fit battery widths from 275 mm to 491 mm. It also accommodates batteries for trucks with standard widths and narrow aisle widths. The roller bed can be adjusted to one of two heights to suit the support arms (270 mm and 320 mm), and the height of each support arm under the bed can be separately adjusted. Additionally, each roller bed on the table is adjustable (25 mm) to compensate, e.g., for truck wheel wear. The feet under the table can be replaced with casters and a handle can be fitted to convert the table into a trolley.



# Appendix

## Parameter setting

### Enter the programming mode for operator 1

- Keep holding the **travel direction selector** depressed and enter the code for operator 1, then press 

As long as the **travel direction selector** is kept pressed, the menu scrolls on the display:

Cl, P, Pn, H and E (see explanation below)

- To enter the parameter mode, release the **travel direction selector** when “P” is displayed in the menu.
- The display shows parameter 1 (steering response) for operator 1

### Proceed to the next parameter

- Push the **lift lever** to proceed to the next parameter

### Parameter sequence

**01) Steering response** (1=low response, 5=high response)

**02) Max. travel speed %** (% of maximum, in increments of 5%)

**03) Max. acceleration %**, (% of maximum, in increments of 5%)

**04) Motor brake %** (% of maximum, in increments of 5%)

**05) Reversing brake %** (% of maximum, in increments of 5%)

### Changing the parameter

- Press the **travel direction selector** and the parameter starts blinking
- The parameter value can be **changed** by using the **lift/lower lever**  
**The Lift lever increases** the value, **while the lower lever reduces** the value

### Confirm the change

- Press the **travel direction selector** and the parameter will then change

### After changing the parameter(s)

- Switch of the truck by pressing the red key and then log in again

### The new parameter set has now been activated

*Cl=clock, P=parameter mode, Pn=firmware version, H=hour meter, E=Error code log*

Function	Default parameter settings									
	1	2	3	4	5	6	7	8	9	10
1) Steering response	3	3	3	3	3	3	3	3	3	3
2) Max. travel speed %	100	100	100	100	100	100	100	100	100	100
3) Max. acceleration %	100	100	100	100	100	100	100	100	100	100
4) Motor brake %	50	50	50	50	50	50	50	50	50	50
5) Reversing brake %	80	80	80	80	80	80	80	80	80	80



## Programming/deletion of height preselection

When programming and using the height preselection feature, it is important that the forks are horizontal.



We recommend selecting a fork tilt angle of 4°/-0.5° when using the height preselection feature, or, alternatively, to carefully make sure the forks are horizontal when programming and driving the truck.

### Programming of level

**NOTE! Programming of the level is only possible in the main lift range, not in the free-lift range.**





- 1) Press . Enter the desired lift height, e.g. **2. PL 02** is displayed.
- 2) Lift the forks to the desired height and press **Lower stop** . The LED will blink.
- 3) Lift the load and wait 3 seconds. Lift the forks slightly to enable retracting the load from the racking – not more than 150 mm.

**NOTE! If the forks are lifted more than 150 mm, this will generate an error code and the programmed position will be deleted.**

- 4) Press **Upper stop** . Both the **Lower stop** and **Upper stop** LED start blinking.
- 5) Press  until both LEDs go out and **PL00** is displayed.
- 6) Press  to return to the display mode.

### Deleting a previously programmed level

**NOTE! When deleting a programmed level, this is only possible in the free-lift range, i.e. the forks must be lowered to the free-lift range to enable deletion of the programmed lift height.**

- 1) Lower the forks until they reach the free-lift range.
- 2) Keep  pressed for a short while, then enter the level to be erased (e.g. 5 = level 5). **PL 05** is displayed.
- 3) Press **Lower stop** . The LED will blink.
- 4) Press **Upper stop** . Both LEDs start blinking.
- 5) Press  so that both the **Lower stop** and **Upper stop** LEDs go out and **PL00** is displayed.
- 6) Press  to return to the display mode.

## Using height preselection

### *Picking up a load*

- 1) Press **Lower stop**  and enter the desired pick-up height level, e.g. **3**.  
**LE 03** is displayed and the **Lower stop** lights.
- 2) Raise the forks using the lift lever. The forks automatically stop at the selected lift height.
- 3) Enter the forks into the fork tunnels and lift the pallet using the lift lever.  
The forks automatically stop when the pallet is lifted.
- 4) Pull in the reach carriage and lower the forks.

### *Setting off a load*

- 1) Press **LOAD**  and enter the desired set-off height level, e.g. **4**.  
**LE 04** is displayed and the **LOAD** LED lights.
- 2) Raise the forks using the lift lever. The forks automatically stop at the selected lift height.
- 3) Extend the reach carriage and lower the forks to set the pallet on the shelf.  
The forks automatically stop when the pallet is lowered.
- 4) Place the pallet on the racking shelf, pull in the reach carriage and lower the forks.

