

# Hobby

Manual

Motor home VAN, VAN Exclusive, Siesta, Siesta Exclusive



Version 03/2011



Dear Camper,

Congratulations on the purchase of your new HOBBY mobile home. The trust you have placed in us is both an incentive and an obligation to continuously implement new ideas, technical innovations and fine touches to make our mobile homes even better. Our fully fitted and highly sophisticated models enable us to offer you the perfect setting for the most enjoyable days of the year.



Please read this user manual carefully, even if you have already been driving a mobile home for quite some time. This will help to prevent operating errors and damage to the vehicle and its equipment. Handling all of the technical details correctly will increase the pleasure you get from driving this vehicle and help to retain the value of your mobile home.

If this user manual should be unable to provide the required assistance, a close, pan-European network of dealers is available for further help. Take advantage of your authorised dealer's experience and technical knowledge - we recommend speaking to him in detail before taking your first trip with your HOBBY mobile home.



We wish you and your fellow travellers many enjoyable trips and hope you will always have a safe journey with your new HOBBY mobile home.

Your  
HOBBY – Wohnwagenwerk  
Ing. Harald Striewski GmbH

**Hobby**

**Chapter 1: Introduction**

1.1	General information.....	01-1
1.2	Before taking your first drive .....	01-1
1.3	Designations in the operating instructions.....	01-2

**Chapter 2: Safety**

2.1	General information.....	02-1
2.2	Fire protection .....	02-1
2.3	Road safety .....	02-2
2.4	What to observe before taking your first drive.....	02-2
2.5	Before and while driving.....	02-3
2.6	Notes for your journey .....	02-5
2.7	Emergency equipment.....	02-8
2.8	When you stop driving .....	02-9

**Chapter 3: Chassis**

3.1	Chassis .....	03-1
3.2	Loading .....	03-1
3.3	Leveling supports.....	03-4
3.4	Entrance step.....	03-5
3.5	Vehicle identification number (VIN) .....	03-6
3.6	Additional pneumatic springs .....	03-6
3.7	Towing fixture .....	03-7
3.8	Externally mounted fixtures .....	03-8

**Chapter 4: Wheels, tyres, brakes**

4.1	Wheels .....	04-1
4.2	Tyres.....	04-1
4.3	Tyre pressure.....	04-2

4.4	Tread depth .....	04-2
4.5	Wheel rims .....	04-3
4.6	Snow chains.....	04-3
4.7	Tyre repair kit.....	04-4
4.8	Changing a tyre.....	04-7
4.9	Brakes.....	04-8

**Chapter 5: Exterior Structure**

5.1	Overview of tank and service flaps .....	05-1
5.2	Ventilation.....	05-5
5.3	Opening and closing doors and flaps .....	05-5
5.4	Roof rail.....	05-10
5.5	Bicycle carrier .....	05-11
5.6	Load carrier .....	05-11
5.7	Sun awning .....	05-12

**Chapter 6: Interior Structure**

6.1	Opening and closing doors and flaps.....	06-1
6.2	Television holder for flat-screen monitor.....	06-6
6.3	Tables .....	06-7
6.4	Bed conversion .....	06-11
6.5	Cushion arrangements.....	06-13
6.6	Alcoves/queen-size bed, rear, crossways.....	06-18
6.7	Windows .....	06-20
6.8	Dimming system for driver's cabin .....	06-22
6.9	Skylight .....	06-23
6.10	Seats in the driver's cabin.....	06-25
6.11	Construction of the seats.....	06-27
6.12	Seatbelts in the caravan.....	06-28

# Hobby

6.13	Overview of the seating arrangements .....	06-29
6.14	Overview of day and night positions.....	06-32

### Chapter 7: Electrical Installations

7.1	Safety instructions .....	07-1
7.2	Elements of the electrical system .....	07-1
7.3	Electric power supply.....	07-6
7.4	Function of the power generating unit.....	07-7
7.5	Caravan battery.....	07-10
7.6	Fuse protection of the electric system.....	07-11
7.7	Mobile navigation.....	07-12
7.8	Subsequently installed devices.....	07-13

### Chapter 8: Water

8.1	General information.....	08-1
8.2	Water supply .....	08-1
8.3	Hot water supply .....	08-5
8.4	Flushing toilet.....	08-5

### Chapter 9: Gas

9.1	General safety rules when using LPG fittings .....	09-1
9.2	Gas supply .....	09-3

### Chapter 10: Built-in devices

10.1	General Information .....	10-1
10.2	Heating.....	10-2
10.3	Electric Heating.....	10-7
10.4	Auxiliary Heating in the Driver's Cab .....	10-8
10.5	Refrigerator .....	10-9

10.6	Gas Cooker .....	10-12
10.7	Oven.....	10-14
10.8	Fume Hood .....	10-15
10.9	Rooftop Air Conditioning .....	10-16

### Chapter 11: Maintenance and Care

11.1	Maintenance .....	10-1
11.2	Airing .....	10-1
11.3	Care.....	10-2
11.4	Winter Lay Up for the Mobile Home .....	11-5
11.5	Winter Operation .....	11-7

### Chapter 12: Sanitation and Environmental Protection

12.1	The environment and traveling.....	12-1
12.2	Returning the vehicle .....	12-4

### Chapter 13: Technical Data

13.1	Weights according to 92/21/EWG .....	13-1
13.2	Inflation pressures .....	13-2
13.3	Technical data.....	13-3
13.4	Tyres and rims for basic motor home vehicles.....	13-7
13.5	Accessory weights .....	13-9

Index .....	ix-1
Appendix .....	A-1

# Hobby

## Chapter 1: Introduction

Our motor homes are continuously being further developed and for this reason we must reserve the right to make changes to the equipment, shape and technology. Certain kinds of accessories are also described in this user manual that are not part of the standard scope of delivery. For this reason, no claims may be asserted against HOBBY based on the contents of this user manual. Those accessories that are available at the time of going to print are described here. They have been applied on a par for all floor plans. Please note that it was not possible to describe all of the individual variations here. If you have any special questions concerning accessories or the technology of the vehicle, your dealer will be happy to answer them.

### 1.1 General information

Your HOBBY motor home has been built in accordance with the latest technology and approved safety regulations. Despite all precautionary measures, however, it is possible that passengers may be hurt or the motor home damaged if the safety instructions in this user manual and the warning stickers placed throughout the motor home are not observed. Please use the motor home only when it is technically in top condition. Any defects that affect the safety of passengers or

**Hobby**

the motor home should be remedied immediately by trained personnel.

The brake system and the gas system should only be checked and repaired by an authorised workshop.

Please ensure that all of the deadlines for checking equipment and inspections are met.

### 1.2 Before taking your first drive

Please do not consider this manual to be just a means of reference, but familiarize yourself thoroughly with it before taking your first drive.

Fill out the guarantee cards in the different manuals for the installed equipment and fittings and send them to the manufacturers. This will ensure guarantee claims for any of the equipment.



In accordance with guarantee conditions, HOBBY's dealer will give you a 5-year guarantee on the consistency of the motor home. Your dealer will give you a guarantee booklet, "5 Years' Guarantee on Consistency" when you pick up your vehicle.



Note: If a consistency test has not been carried out, you will forfeit any claims for a 5-year guarantee on consistency.

Please note the following before operating the vehicle:

- **Check the tyre pressure.**  
Please refer to the section on tyre pressure
- **Load the vehicle correctly. Keep to the technically permissible overall mass.**  
Please refer to the section on loading.
- **Charge up the batteries fully before each journey**  
Please refer to the section on the starter battery.
- **If the temperature outside is below 0° C, heat the vehicle before filling up the water system.**  
Please refer to the section on water supply/filling the fresh water tank.
- **Tighten the wheel nuts after having driven the first 50 km.**
- **Switch off all fitted devices that operate on gas before filling the petrol tank.**
- **Tightly strap gas bottles in the gas bottle box during transportation.**
- **When camping in winter, heat the vehicle at night if there is danger of frost.**  
Please refer to the section on operating in winter/heating.
- **Keep compulsory ventilation clear.**  
Please refer to the section on windows/roof fan/airing.
- **When the vehicle is not in use, empty the entire water system and leave the water faucets open in a neutral position. This prevents the water system from being damaged by frost.**  
Please refer to the section on emptying the water system.

### 1.3 Designations in the operating instructions

This manual explains the motor home in the following manner:

#### Texts and illustrations

Texts that refer to illustrations are found directly below the illustrations.

Details in illustrations (here: entrance) have been given item numbers ①.

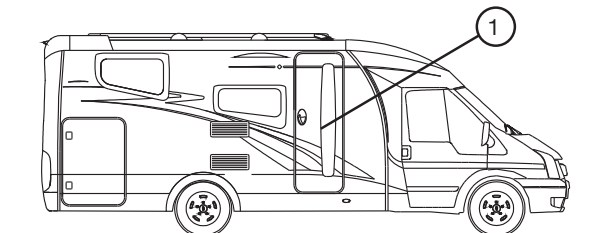

#### Lists

Lists are given in the form of key words and shown as bullet points using “-“.

**Hobby**

### Handling instructions

Handling instructions are also given in the form of key words beginning with the symbol “•”.

### Notes



Notes point out important details that ensure your motor home and its fittings will function perfectly. Please remember that there may be some differences in description to the various kinds of equipment that can be supplied.

### Warnings



Warnings make you aware of dangers that may lead to material being damaged or even people being hurt if they are not observed.

### Environmental Tips



Environmental tips give you possibilities for lessening the impact on the environment.

# Hobby

# Hobby



## Chapter 2: Safety

### 2.1 General information

- Ensure that there is sufficient ventilation. Never cover built-in compulsory ventilation (skylights with compulsory ventilation or roof fan). Keep compulsory ventilation free of snow and leaves - danger of suffocation!
- Operating and user instructions for built-in equipment (refrigerator, heating, cooker, etc.) as well as for the basic vehicle must be observed at all times.
- If accessories or optional equipment is to be installed, this may change the measurements, weight and road performance of the engine home. Some accessories must be registered and entered in the vehicle's papers.
- Use only tyres and rims that have been approved for your engine home. Please refer to the vehicle's registration papers for information on tyre and rim sizes.

### 2.2 Fire protection

#### Precautions against fire

- Never leave children alone in the vehicle.
- Keep inflammable materials away from all heating and cooking devices.
- Any changes to the electric system, accelerator system or built-in devices may only be carried out by an authorised workshop.
- Install a fire extinguisher next to the main entrance.
- Store a fire blanket near the cooker.
- Do not block any escape routes.
- Familiarise yourself with all safety measures set up on the property.

#### Fighting fire

- Immediately evacuate all passengers.
- Close the main stop valve on the accelerator cylinder and the accelerator stop valves for the consumer loads.
- Turn off the electric supply.
- Sound the alarm and call the fire department.
- Only fight the fire yourself if you can do so without risk.

**Hobby**

## 2.3 Road safety

- Before driving, check that the signal and light equipment, steering and brakes all function properly.
- If the vehicle has been standing for a longer period of time (approx. 10 months) have an authorised workshop check the brake system and the accelerator system.
- Completely open and fasten the dimming system on the front and side windows.
- While moving all passengers must be secured with seat belts and may not move around in the vehicle.
- In winter, the roof must be cleared of snow and ice before driving.
- Regularly check the tyre pressure before driving. False tyre pressure can cause excessive wear, damage to the tyres or even lead to a burst tyre.
- Child seats may only be mounted on seats that have a three-point seat belt installed by the factory.
- Turn the reversible seats in the direction of travel and lock them. The seats may not be turned while driving.

## 2.4 What to observe before taking your first drive

### Vehicle registration

Every vehicle that drives on public roads must be registered. This also applies to your new engine home. Apply for registration at your local Driver and Vehicle Licensing Agency.

### You must show the following when applying for registration:

- Motor Vehicle Registration Certificate Part II / Certificate of Conformity (CoC)
- insurance coverage
- proof of personal identity or confirmation of registration by a local authority
- if applicable, power of attorney to register the vehicle
- If applicable, the direct debit authorisation for motor vehicle tax

### General inspection

In common with passenger cars new engine homes with a permissible total weight up to 3.5 tonnes do not have to undergo a general inspection for the first three years after initial registration. After this they must undergo a general inspection every two years. Engine homes weighing between 3.5 and 7.5 tonnes must undergo a general inspection every two years during the first six years following initial registration. After this a general inspection must be carried out every year.

# Hobby

The general inspection can be carried out by the German Technical Surveyance Association (TÜV), the German Engine Vehicle Surveyance Association (DEKRA) or an officially approved expert.



Any changes made to the vehicle that underlie German Road Traffic Licensing Regulations must be officially authorised!



If you have any further questions or difficulties, your authorised Hobby dealer will always be available to assist you!

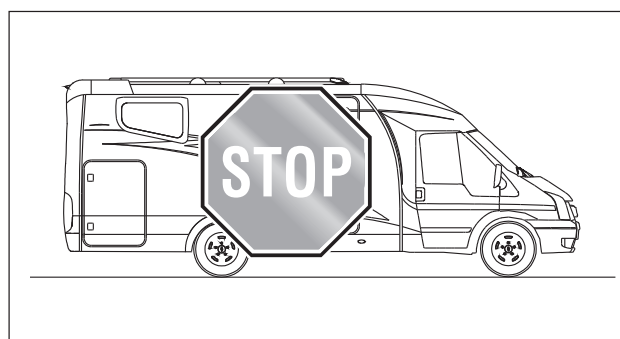

## 2.5 Before and while driving

As the owner / driver of the vehicle, you are responsible for the state of the vehicle. Please observe the following points:

### Preparing the vehicle

Check the exterior of the vehicle and carry out the following preparations before driving:

#### Preparing the vehicle

- If the levelling supports have been extended, retract them.
- Close all the windows in the engine home as well as skylights in the roof.
- Retract the entrance step.

**Hobby**

- Close the tap for the waste water tank.
- Close all taps and quick-action stop valves for accelerator devices. The only exception is for the heating if this should be used while driving.
- If necessary remove the 230 V electric cable from the exterior socket.
- If necessary, retract the satellite dish.
- If necessary retract the TV aerial as far as possible or fold down the satellite dish.
- If necessary secure any loads on the roof ensuring that they cannot slide.
- If necessary secure bicycles; ensure that they cannot slide and check that the existing lighting systems are not covered.
- If necessary turn off the light in the tent in front of the engine home.

## Interior

Some preparations must also be carried out inside the mobile home.

### Preparing the interior

- Sort loose objects and stow them in the compartments.
- Place heavy objects in the lower compartments.
- If necessary switch the refrigerator to 12 V operation.
- Ensure that no liquids, including those in the refrigerator, will leak.
- Secure accelerator cylinders.
- Secure the table and, if possible, lower it.
- Turn off interior lights.
- Close doors (including refrigerator door), drawers and flaps firmly.
- Heavy and/or voluminous objects (e.g. TV, radio) must be secured before driving.
- Completely open and secure the optional cockpit dimming system.



Do not overload the vehicle! It is imperative that you not the permissible axle loads, the technically permissible overall mass as well as the permissible height, width and length of the mobile home.



Place a not with all important measures and weights in a visible place in both the caravan and the driver's cabin.

# Hobby

## Driver's cabin

### Do not forget the following:

- Adjust the interior and exterior mirrors as well as your seat.
- Check the lights.

### In addition:

- Check your tyre pressure.
- Check all liquids, such as oil, cooling water, brake fluid and windscreen cleaning liquid, and fill them up if necessary.
- Turn off all accelerator devices (heating, refrigerator, etc.) before putting petrol in the tank.

### Before driving off

Before you drive off you should be able to answer the following questions with "yes":

- Is there a first-aid kit; a warning triangle and a warning jacket on board?
- Are all the lights working (headlights, dipped headlights, brake lights and indicators)?

# Hobby

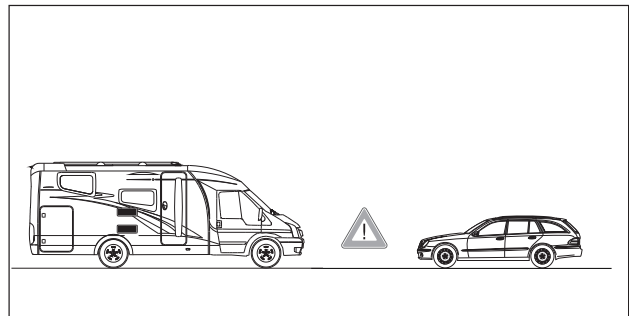

## 2.6 Notes for your journey

### Your mobile home is not an automobile!

In many situations, it reacts very differently to a "normal" automobile. Therefore, you should be prepared for the following differences:

### Loading

#### The following applies for loading:

- Load evenly. Heavy or bulky objects should be placed in the lower compartments!
- In the interior, store luggage in cupboards and compartments.
- Secure all doors and flaps.

- After you have finished loading, check the overall weight on a public scales.

### Roof load (50 kg maximum)

The height of the mobile home may vary from one journey to the next due to different roof loads.

#### The following applies for roof loads:

- Add the measurement of the roof load to the height of the mobile home.
- Place a not visibly in the driver's cab giving the overall height. This saves having to calculate the height when driving under bridges and through tunnels.

### Rear garage

When loading the rear garage adhere to the permissible axle loads and the technically permissible total mass. Distribute payload evenly. Excess point loads will damage the floor covering.



- The maximum permissible load for the rear external storage locker is 200 kg (Fiat) or 350 kg (Iveco).
- On no account should the permissible rear axle load be exceeded.
- Due to load removal on the front axle, it is considerably more difficult to handle the vehicle when the rear garage is fully loaded.

### Passenger safety

#### The following applies while driving:

- Only those seats equipped with safety belts may be used by passengers.
- While driving, passengers may not stay in the alcove or the beds.
- Passengers must remain in their seats with their seat belt on!
- Do not open the door latch!
- No extra passengers may remain in the vehicle!

### Braking

#### The following applies for braking:

- Not the longer braking distance, especially on wet roads.
- When driving downhill, select a gear that is not higher than when driving uphill.

### Reversing/Manoeuvring

#### Your engine home is far larger than a car.

#### The following applies to reversing/manoeuvring

- Even if the wing mirrors are correctly adjusted there is a significant blind spot.
- When reversing or parking in places with poor visibility get help to guide you in.

**Hobby**

## Driving

Take a trial drive before leaving on your first large journey in order to familiarize yourself with the mobile home. Remember to practise reversing. The base vehicle is a commercial vehicle; adjust your driving style accordingly.

### The following applies for driving:

- Do not underestimate the length of the engine home. Due to the relatively long rear overhang larger vehicles can veer to one side and, in unfavourable conditions, the rear can hit the ground.
- Be careful when driving into inner courtyards and through entrance gates.
- The mobile home may start to swing from side to side in cross-winds, on wet or icy roads.
- Adjust your speed to road and traffic conditions.
- Long descents with a slight gradient can become dangerous. Adjust your speed from the very beginning to allow you to speed up if necessary without endangering other automobiles.
- As a general rule, never drive faster downhill than uphill.
- The mobile home may be caught up in a slipstream when overtaking or being overtaken by lorries with trailers or buses. This effect is counteracted by lightly counter-steering.
- Use foresight while driving; take regular breaks on longer drives.

## Hobby

## Driving around corners

Due to its height, a mobile home begins to sway more quickly than an automobile.

### The following applies for driving around corners:

- Never drive too quickly into a corner!

## Driving economically

The engine of your mobile home has not been designed to drive constantly under a full load.

### The following applies when driving:

- Do not keep your foot down on the accelerator!
- The final 20 km/h before reaching top speed require up to 50 % more fuel!

## Getting petrol

A number of devices that use an open flame have been built into your mobile home.

### The following applies when getting petrol:

- Turn off all accelerator devices (heating, refrigerator, etc.)!
- Turn off all mobile phones!
- Never get anything other than diesel fuel.
- Never mistakenly fill the fresh water tank with fuel.

## 2.7 Emergency equipment

To be prepared in case of an emergency, you should always carry the three emergency devices on board and familiarize yourself with them.

### First-aid kit

The first-aid kit should always be at hand and have a fixed position in your mobile home. Any objects removed from the first-aid kit should be replaced immediately. Expiry dates should be checked regularly.

### Reflective jacket (not included in scope of delivery)

In acc. with EN 471, we recommend that you carry and wear a reflective jacket with white retro-reflective stripes whenever you leave the vehicle on open roads and emergency strips. The driver should wear this jacket when the vehicle

- comes to a stop outside city limits on an obscure rural road because of an accident or breakdown, if the view is poor due to bad weather, in twilight or darkness, or
- when it must be secured by means of a warning triangle on the emergency strip of the engine way because of an accident or breakdown.

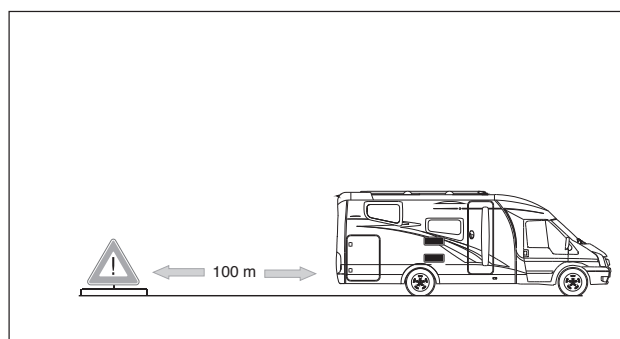

### Warning triangle

The warning triangle should also always be at hand and have a fixed position in your mobile home, preferably together with the first-aid kit.

### In an emergency

- Set up the warning triangle at least 100 m in front of the danger zone!

# Hobby



## 2.8 When you stop driving

### Selecting a parking space

**The following applies for selecting a parking space:**

- Select a parking space that is as level as possible.
- If possible, pick your spot in daylight.

### Securing the vehicle

**The following applies when securing the vehicle:**

- Put the vehicle in gear.
- Pull on the handbrake.
- If necessary, extend extra vehicle supports.
- If necessary, use blocks (not in scope of delivery).



If the temperature is below 0°C only put the handbrake on lightly and ensure that the vehicle is in gear to prevent the handbrake from freezing up!



When turning the driver's seat, ensure that you do not accidentally disengage the handbrake.

### Switching electric consumption:

**The following applies when switching electric consumption:**

- Switch the refrigerator from 12 V to accelerator or 230 V. Otherwise, if the engine is not on, the 12 V electrical supply will automatically turn itself off after a few minutes.
- Open the main stop valve on the accelerator cylinder and the accelerator stop valve on the consumer required.

### Water system

Empty the entire water system if the vehicle is not heated when there is danger of frost. Leave the water faucets as well as all drain valves open to prevent damage from frost.

Water that has been left to stand in the fresh water tank or water pipes quickly becomes undrinkable. Therefore always flush the water pipes thoroughly with several litres of fresh water before using them.

# Hobby

## Saving energy in winter

It is very easy to save energy inside your mobile home. This applies especially to heating in winter.

### The following applies for saving energy:

- Meter the exact use of ventilation in the vehicle and the heating valve.
- Install winter mats on the inner sides of the driver's cabin and the windscreen (not included in scope of delivery).
- Install an insulation mat between the driver's cabin and the caravan (not included in scope of delivery).
- Open the door as little and as briefly as possible.
- When camping in winter, it is possible to put up a small tent in front of the vehicle as protection against the cold.

**Hobby**

## Chapter 3: Chassis

### 3.1 Chassis

The chassis includes parts of the frame and the axles. No technical changes may be made, as otherwise the general type approval will expire!



Technical changes may only be carried out after being released by the manufacturer.



For further information, please refer to the enclosed operating instructions for the basic vehicle.

### 3.2 Loading



The maximum axle loads as well as the technically permissible overall mass entered in the vehicle's documents may not be exceeded.

#### Weights of motor homes in accordance with 92/21/EWG



Please refer to the definition of masses for motor homes!

### Definition of Masses for Motor homes

Throughout Europe, EU Guideline 92/21/EWG is applicable for calculating the masses (weights) and resulting loads for motor homes. The terms and basis used for calculations are explained below.

#### 1. Technically permissible overall mass

Information regarding the technically permissible maximum weight is based on Hobby Wohnwagenwerk's specification in cooperation with the manufacturers of the previous construction stages (FORD). This weight was determined in detailed calculations and tests. It is specified in the basic approvals and, for safety reasons, it must not be exceeded under any circumstances.

#### 2. Mass when the vehicle is ready to start

The mass when the vehicle is ready to start corresponds to the mass of the empty vehicle including lubricants, tools, spare tyre (and/or repair kit), petrol (100 %), booster battery, all of the standard equipment mounted by the factory as well as 75 kg for the driver, plus basic equipment (gas, water, electric).

#### 3. Basic Equipment

The basic equipment includes the masses for the fresh water and gas storage containers, which have been filled to 90 % of their total capacity. The masses for the individual models are calculated in detail as follows:

# Hobby

	<b>Siesta, Siesta Exclusive, Van Exclusive and Van</b>	
		Reduction of load capacity for T 650 ESC LE to 3,500 kg
<b>a) Supply of liquefied petroleum gas</b>		
Number of built-in gas regulators:	1	1
Weight of an 11 kg aluminium bottle:	5,5	5,5
Weight of 11 kg gas inflation (90 %):	9,9	9,9
<b>Total:</b>	<b>15,4</b>	<b>15,4</b>
<b>b) Liquids</b>		
200 l fresh water tank (90 %)	-	-
100 l fresh water tank (90 %)	90	-
10 l fresh water tank (90 %)	-	9
<b>c) Electric power supply</b>		
<b>Cable drum</b>	4	4
<b>Total basic equipment:</b>	<b>109,4 kg</b>	<b>28,4 kg</b>

# Hobby

#### 4. Loading

The additional load is equal to the "technically permissible maximum weight" minus the "weight (mass) when ready to drive". This value must take into account the weights for passengers (conventional load: 75 kg x no. of seats - with the exception of the driver), additional equipment (e.g. additional packages, bicycle carrier(s), tow coupling, air conditioner, awning, etc.) and personal equipment (clothes, leisure articles, food, camping tables and chairs, etc.).



Check to ensure that the masses of all objects transported in the motor home have been taken into consideration, e.g. passengers, additional equipment, basic equipment and personal belongings such as clothes, food, pets, bicycles, surfboards, other sport equipment, etc.).



Under no circumstances may the technically permissible total load be exceeded when the motor home has been loaded.

The mass when the vehicle is ready to start includes an additional value for liquids and gas, etc. (see basic equipment). Part of this additional value can also be used for additional loads if, for example, you would like to travel with empty water tanks or without gas bottles.

## Hobby

#### 5. T 650 ESC LE with a permissible maximum weight of 3,500 kg



Before driving, you must open the overflow valve for the fresh water tank.

To reduce the weight when the vehicle is ready to start, the fresh water tank has been fitted out with an overflow valve, located to the right in the seat and marked with a warning sign. Before you begin driving, open the overflow valve. The contents of the fresh water tank will run off until, for weight reasons, only approx. 10 litres are left. When the vehicle is standing, the valve can be closed, allowing you to use the full volume of the tank.

A reduced fresh water supply when the vehicle is ready to start has been entered in the vehicle's registration papers. The motor home may only be operated on public roads when the overflow valve is open. The driver is responsible for ensuring that this requirement is fulfilled as well as for observing the technically permissible total weight.

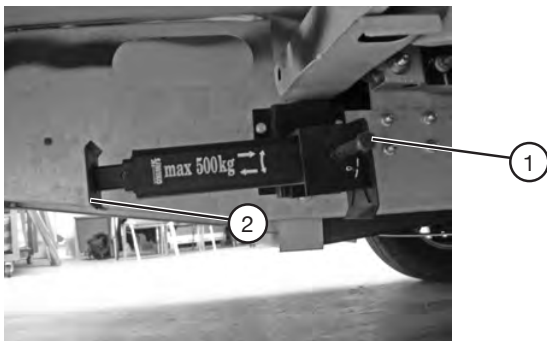

### 3.3 Levelling supports

The optional levelling supports are located in the rear area by the frame extension.

#### Swinging out the levelling supports

- Place the crank on the hexagon head ① .
- Turn the crank to move the support to a vertical position.
- If necessary, secure the foot ② to prevent it from sinking into the ground and place it on a firm base.
- If the levelling support is in a vertical position, the support will extend telescopically.
- Use the crank to level the levelling supports until the vehicle stands level.



#### Retracting levelling supports

- Use crank to release levelling supports.
- Continue to crank smoothly until the levelling support is once again in its initial horizontal position.



- Do not use the levelling supports as a car jack. Their sole purpose is to stabilise the motor home when it is parked.
- Always load the levelling supports evenly.
- Always retract the levelling supports and secure them before driving.
- Clean the levelling supports regularly and grease them slightly.



The telescopically adjustable foot may only be extended as far as the yellow marking!

**Hobby**



### 3.4 Entrance step

Your motor home has an electric entrance step ①.

Use the switch ② on the inside, next to the entrance door to activate it.



Do not step on the entrance step until it has been completely extended!



Mind the different heights of the steps and ensure that the ground in front of the entrance is firm and level.



After a slight delay the step will automatically be retracted when the engine is started.

# Hobby



### 3.5 Vehicle Identification Number (VIN)

The 17-digit Vehicle Identification Number is engraved in the right front side wheel arch. To improve readability the VIN is repeated on a label to the left of the instrument panel and is legible from outside the vehicle. In addition to this, the VIN is given on both the Ford model plate (on the B-pillar, passenger side) and on the Hobby model plate (in the engine compartment, at the front on the radiator bridge). Please have the VIN to hand when making any enquiries and on every visit to your dealer.



### 3.6 Additional pneumatic springs

Additional pneumatic springs on the rear axle (optional extra) provide a significant improvement to the motor home's road handling and complement the standard suspension. The air bellows lift the vehicle's tail as required.

The compressor is activated from the driver's cabin operating panel using the On/Off button ①, thereby filling the bellows with air. The manometer ③ can be used to provide continuous information regarding the current pressure in the system. Should excess pressure occur the excess air can be released from the system using the ventilation button ②.

**Hobby**



The optimum air pressure is achieved when the vehicle is standing horizontally. The minimum air pressure must be high enough to ensure that the air bellows cannot snap through. When the vehicle is empty this pressure is approx. 0.5 bar (please check individually); when the vehicle is loaded the value will be correspondingly higher, depending on the loading.



The maximum permissible operating pressure of the system is 4.0 bar.

In order to avoid damage to the air bellows during maintenance work they should be checked for any accumulation of waste or dirt and, if required, cleaned.



The following cleaning agents are approved for cleaning the air bellows: soap suds, methanol, ethanol and isopropanol.

### 3.7 Towing fixture

As an optional extra your motor home can be equipped with a fixed tow bar. Please see the registration documents for information concerning the tow bar load and the rear axle load.



Adhere to the permissible tow bar load and rear axle load, in particular in conjunction with loading of the rear garage.

Simultaneous use of the towing fixture and the rear load carrier is not permitted.

While manoeuvring to hitch and unhitch loads, ensure that no-one is standing between the motor home and the trailer.



Due to stipulations by the manufacturer of the basic vehicle and the fixing of the so-called D value of the towing fixture no additional loading of the towing loads is possible.

### 3.8 Externally mounted fixtures

#### Registering accessories in the vehicle's documents

- Have your HOBBY dealer mount your externally mounted fixtures.
- Take your mobile home to a technical support organisation or technical service provider (e.g. MOT).
- The technical support organisation will approve the fittings and draw up a corresponding expertise.  
(road traffic authorities)
- Take the expertise and the registration documents, Parts I and II, to the Driver and Vehicle Licensing Agency. They will copy the changes into the vehicle's documents.



Do not forget that towbar couplings, motorcycle carriers, levelling devices and/or additional spring blades must be registered.



Please note that mounting additional equipment reduces the load your motor home can carry.

# Hobby

## Chapter 4: Wheels, tyres, brakes

### 4.1 Wheels

On your first drive with your motor home, please check that your tyre bolts are still securely tightened after having driven 50 km and, if necessary, tighten them with a torque of **160 Nm for 15" wheel rims (steel and light metal) and 180 Nm for 16" wheel rims (steel and light metal)**. After this, the tyre bolts should be checked regularly that they are securely tightened.

### 4.2 Tyres

Use only tyres that have been entered in the vehicle's documents. Other tyre sizes may only be used if they have been permitted by the manufacturer of the basic vehicle.

#### Driving to protect your tyres

- Avoid braking sharply and racing starts.
- Avoid long drives on poor roads.
- Never drive an overloaded vehicle.



Tubeless tyres have been mounted on your HOBBY motor home. Under no circumstances may tubes be inserted in these tyres!



#### Winter tires are mandatory in many EU countries!

If you are driving in snow, ice or sludge in one of these countries, your vehicle must be fitted with tires that have the "M+S" symbol. You may be fined if you ignore this legal requirement.

**Hobby**

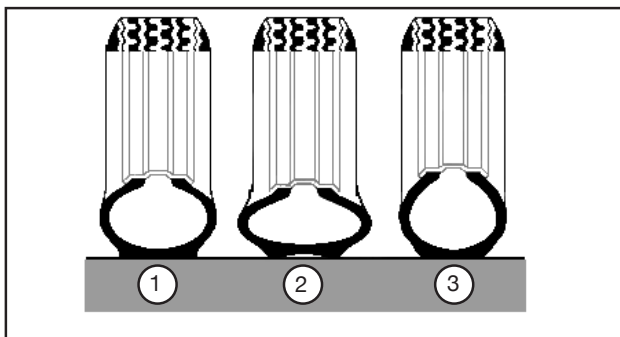

### 4.3 Tyre pressure

The inflation pressure of all tyres as well as the spare tyre should be checked approx. every 4 weeks and before you go on longer journeys.

#### The following applies when checking inflation pressure:

- Check the pressure only when the tyre is cold (also refer to Table 12.2 Tyre Inflation Pressure).
- If checking or correcting the pressure of a warm tyre, the pressure must be 0.3 bar higher than for a cold tyre.

#### The following applies for inflation pressure:

- correct inflation pressure ①.
- inflation pressure too low ②.
- inflation pressure too high ③.



If the pressure is too low, this may cause overheating of the tyre, possibly resulting in severe damage to the tyre.



For the correct inflation pressure, please refer to the table in the chapter on "Technical Data" or the operating instructions for the basic vehicle.

### 4.4 Tread depth

Replace your tyres as soon as the tread depth is only 1.6 mm.



The minimum tread depth gives you only the barest amount of safety while driving. The following recommendations must be observed:

Safety limit in summer: 3.0 mm  
Safety limit in winter: 4.0 mm

Tyres may not be exchanged crosswise, i.e. from the right side of the vehicle to the left and vice versa.



Tyres age even if they are used seldom or not at all.

#### Tyre manufacturers' recommendations

- Irrespective of their tread depth, tyres should be changed every 6 years.
- Avoid hard impacts against curbs, potholes or other obstacles.

**Hobby**

### 4.5 Wheel rims

Use only those wheel rims listed in the vehicle's documents. Please observe the following points, should you wish to use other wheel rims.

**The following applies when using other wheel rims:**

- Size,
- construction,
- injection depth and
- The load bearing capacity must be sufficient for the permissible total axle weight.
- The cone of the fastening screw must correspond to the construction of the wheel rim.

Adaptations are only permitted if these have been released by the manufacturer.

Aluminium wheel rims must be tested separately for each type of vehicle. The screws used on aluminium rims may not be used for steel rims. When using aluminium rims, tyres may not be changed from the front to the back or vice versa.

### 4.6 Snow chains



Use snow chains only on the front axle.



Never drive faster than 50 km/h.



Do not use snow chains on snow-free roads.



Ornamental hub caps must be removed before putting on snow chains.

### Models with front-wheel drive

If you wish to use snow chains, the wheels on the front axle must use tyres size 195/75 R 16 C (M+S) on steel rims 5.5 J x 16 H2, ET 50. You may leave the tyres size 215/75 R 16 C on the rear axle. This tyre mix is covered by Ford's basic approval and, therefore, does not require extra permission.

Tyres size 195/75 R 16 C (M+S) must be inflated to the maximum admissible pressure of 4.8 bar. Snow chains may only be used with steel rims and only on the front axle.

# Hobby



#### 4.7 Tyre repair kit

Do not use the tyre repair kit if the tyre was damaged as a result of driving without air. Small cuts, especially in the tyre tread, can be resealed using the tyre repair kit. Do not remove foreign bodies (such as screws or nails) from the tyre. The tyre repair kit can be used at outside temperatures to a minimum of approx. -30°C.

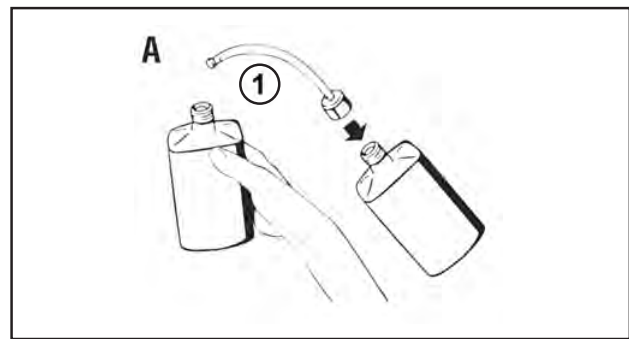

- A** Shake the bottle. Open the fill hose ① on the bottle (foil seal is thereby punctured).

**Hobby**

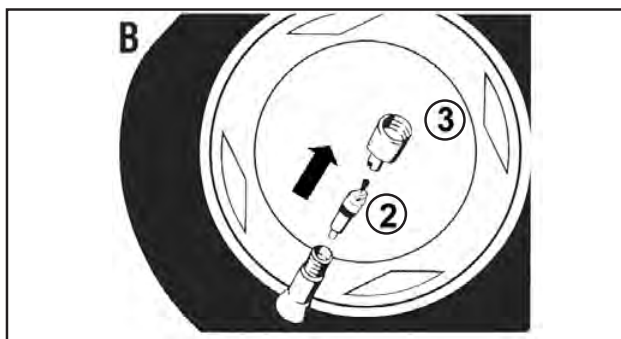

**B** Unscrew the valve cap from the tyre valve. Remove the valve insert ② with the valvecore remover ③. Do not lay the valve insert ② down in sand or dirt.

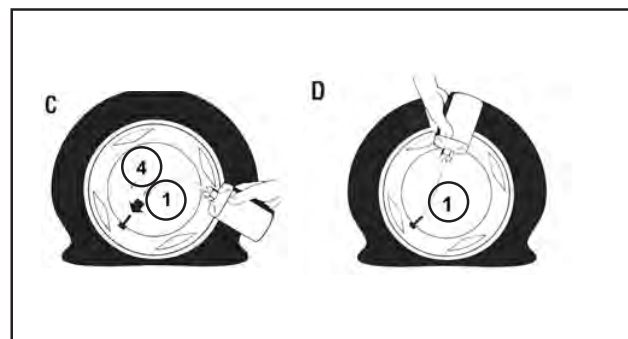

**C** Pull the stopper ④ from the fill hose ①. Push the fill hose onto the tyre valve.

**D** Hold the bottle down with the filling tube and then press them together. Press the entire bottle contents into the tyre. Pull the fill hose off ① and screw the valve insert ② tightly into the tyre valve with the valve-core remover ③.

**Hobby**

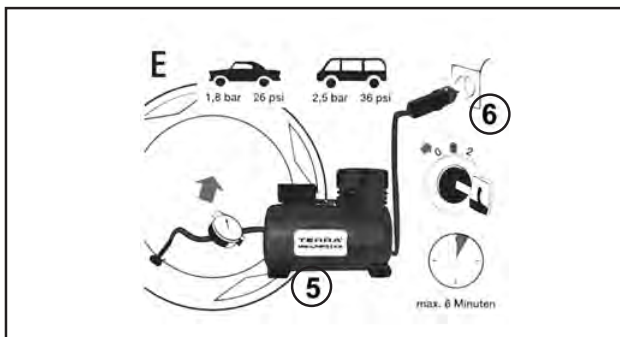

- E** Open the air hose (5) on the tyre valve. Insert the plug (6) into the cigar lighter socket. Then pump the tyres (Fig. 7). do not operate the electric air pump longer than 8 minutes! Danger of overheating! If sufficient air pressure is unattainable, drive 10 meters (either forward or in reverse) so that the sealant can be evenly distributed within the tyre. Repeat the pumping process. Resume driving immediately, so that the sealant can be evenly distributed within the tyre.

**Maximum speed: 80 km/h. Especially in curves.**

Check tyre pressure after driving 10 minutes. If the tyre pressure has fallen under this minimum value (8), you may not drive any further.

If the minimum value is still indicated (8) correct the tyre pressure according to Table 12.2. Drive carefully to the nearest workshop and have the tyre replaced.



**Danger of accidents:** If the required tyre pressure is still unattainable the tyre is too severely damaged. In this case the tyre repair kit can no longer provide an effective seal. Do not, therefore, drive any further. Notify a service station or the 24-hour service hotline.

**Hobby**



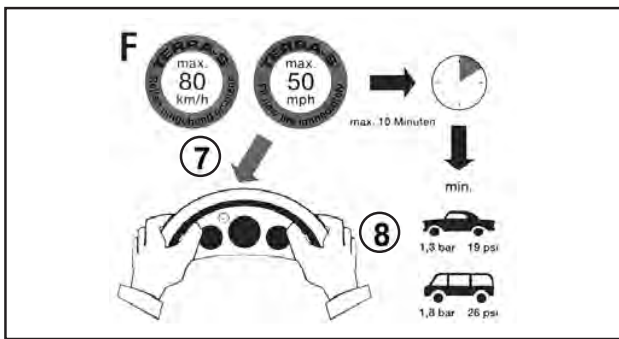

**F** Adhere the provided sticker to the combination panel within sight of the driver. Dispose of used tyre repair kit at a service station.



**Danger of accidents!** Have the tyres replaced at the nearest service station.

## 4.8 Changing a tyre



The car jack may only be inserted in the appropriate mounting holes! If the car jack is attached in other places, this may cause damage to the vehicle or even accidents if the vehicle falls off the jack.



The car jack is to be used only for changing tires. It may never be used when working underneath the vehicle! Danger of death!



The levelling supports may not be used as a car jack!



When changing a tire, please also observe the vehicle manufacturer's operating instructions.

### Changing a tire

- Place a firm base, such as a piece of wood, underneath the car jack if the vehicle is on soft ground.
- Insert the car jack into the appropriate mounting holes.
- Turn the wheel spanner a few times to loosen the wheel mounting screws, but do not remove them.
- Jack up the vehicle until the wheel is 2 -3 cm above the ground.

- Remove the wheel mounting screws and lift off the tire.
- Place the spare tire on the wheel hub and align it.
- Screw the bolts on and tighten them in a diagonal sequence.
- Lower the car jack and remove it.
- Tighten the wheel mounting screws evenly with the wheel spanner. Please refer to the operating instructions for the base vehicle for the specified value of the tightening torque of the wheel mounting screws.
- Place the tire you have removed in the (possibly existing) spare tire holder and then shut the holder.

## 4.9 Brakes

The components in the brake system are part of the General Type Approval (“Allgemeinen Betriebserlaubnis“, ABE). If you change the components in the brake system, the type approval expires. Any changes are only possible if they have been released by the manufacturer.



In your own interests, you should have the brakes checked regularly by your Fiat or Peugeot repair shop.

### The following applies when maintaining the brake system:

- Check the level of brake fluid regularly.
- Check the brake system and brake hoses regularly for leakage. Martens often gnaw at rubber hoses.
- Use only brake fluids with the same qualities as those fluids already in the brake circuit.



Further information is given in the operating instructions for the Ford Transit.

**Hobby**

## Chapter 5: Exterior Structure

### 5.1 Overview of tank and service flaps

T500 GFSC Van Classic

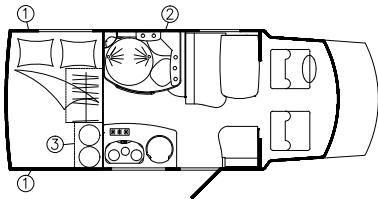

TL500 GESC Van Exclusive

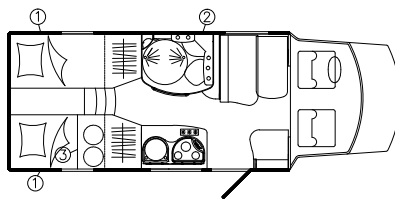

T600AK KM Siesta

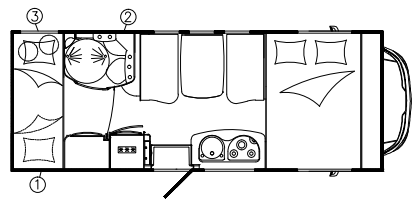

T500 FSC Van Classic

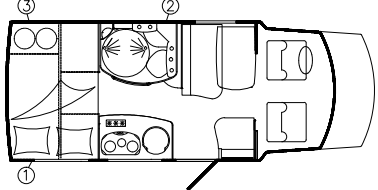

T555 GFSC Siesta

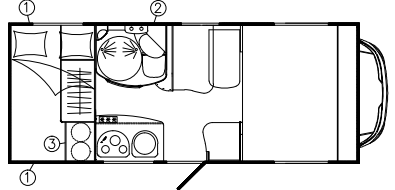

T650AK GFM Siesta

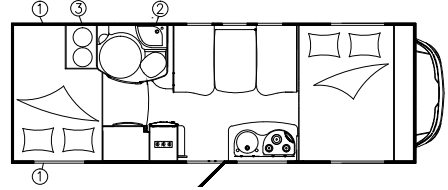

Storage flap ①  
Toilet flap ②  
Gas box flap ③

**Hobby**

T600AK FC Siesta Exclusive

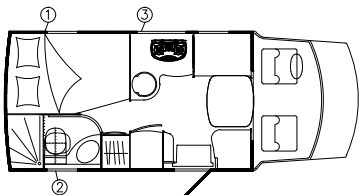

T650 ESC Siesta Exclusive

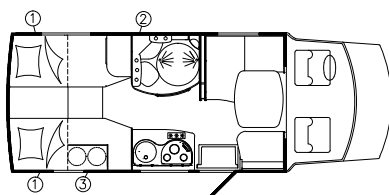

T650 FLC Siesta Exclusive

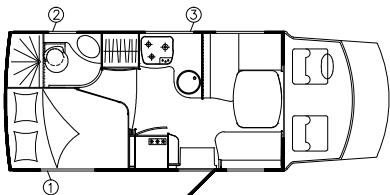

- Storage flap ①
- Toilet flap ②
- Gas box flap ③

Hobby

## 5.2 Ventilation

### The following applies for ventilation:

Ventilation is important if you want to feel comfortable in your motor home. No-draught ventilation has been integrated above the driving unit in your motor home. The roof lights ensure ventilation. Never interfere with the way in which they operate.

Appropriate covers can be used to close the ventilation of the refrigerator, provided it does not run on gas.



Never cover the safety ventilation, not even partially.



Note the information given on the covers. They may only be used when the refrigerator is operated electrically in winter. For more information, please refer to the refrigerator manufacturer's operating instructions.



Watery vapour is produced while cooking, from wet clothes, etc. Every person transpires up to 35 g of water per hour. Therefore, depending on the relative humidity, the windows and skylights must be opened for further ventilation (see also "Operating in Winter").

# Hobby

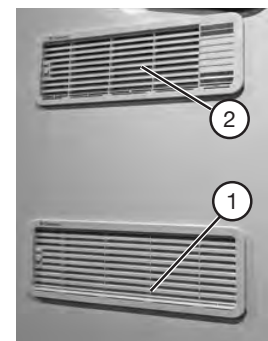
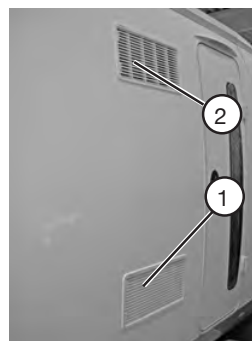

## Refrigerator

Grates supply the refrigerator with fresh air from outside to ensure sufficient refrigerating capacity. The grate for fresh air intake ① is on the outside wall of the vehicle. The grate for expelling used air ② is above the grate for fresh air intake.



Danger! You can suffocate if the ventilation openings are blocked! Never block ventilation openings.



Apply special covers when operating the motor home in winter. These covers can be purchased from your dealer.

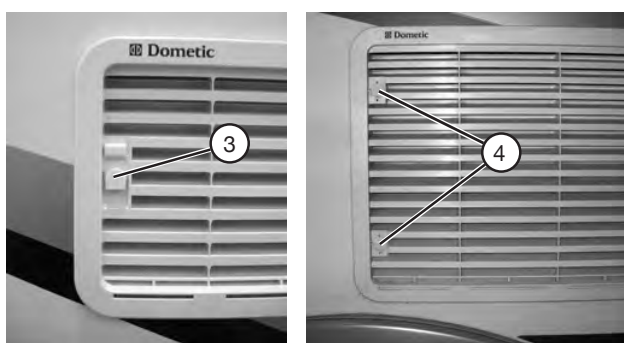

We recommend that you remove the ventilation grate if the outside temperature is very high. This allows more air to permeate to the refrigerator, intensifying refrigeration. The ventilation grids must remain firmly mounted while driving or when it is raining.

#### Removing the ventilation grate

- Push the lock ③ as far up as it will go. (Turn the locks ④ to the right.)
- Carefully lift open the ventilation grid on the left-hand side.
- Then pull the right-hand side out of the bracket.



#### Heating

The heating system is supplied with fresh air from outside ①. This ventilation flap also permits exhaust air from the system to escape.



Blocked ventilation openings can lead to suffocation! Therefore, never block ventilation openings. When operating in winter ensure that the chimney outlet is not blocked.

**Hobby**

### 5.3 Opening and closing doors and flaps

#### Keys to the vehicle

The following keys are supplied with the motor home:

- two keys for the following locks on the basic vehicle:
- Driver's and passenger door plus bonnet unlocking mechanism.



Note the manufacturer's operating instructions for the basic vehicle.

- two keys that fit the following locks on the structure:
  - entrance door
  - service flaps
  - toilet flaps



#### Entrance door external

##### Opening

- Use key to unlock door.
- Pull on door handle.
- Open door.

##### Closing

- Close door.
- Turn key until you hear the bolt lock into place.
- Turn key back to verticle position and pull it out.

**Hobby**

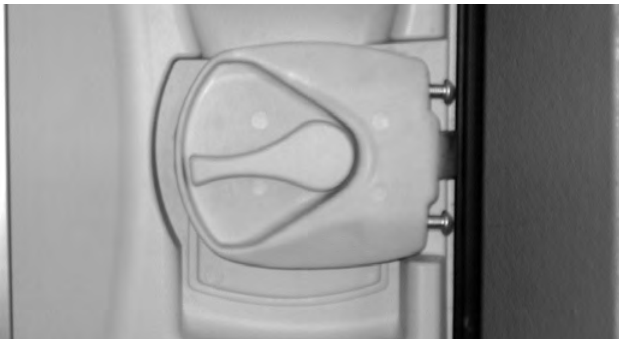

### Entrance door internal

#### Opening

- Push the bolt down.



This allows a door which has been locked from the outside to be opened from the inside.



#### Closing

- Pull the door shut until you hear it lock.

#### Locking

- Push the bolt up.



The entrance door is your escape route in case of emergency. Never obstruct the door from the outside.



To avoid damaging the lock and the doorframe, the inner door handle must be in a horizontal position and not slanted upwards.

## Hobby





### Luggage trunk flap

#### Opening

- Use key to unlock flap.
- Place your hand over the lock and give the flap a strong push inwards.
- Swing flap up and secure it with the hook.

#### Closing

- Lift the arrestor hook up and unlatch the flap.
- Swing flap down.
- Lock it with the key.



### Toilet flap

#### Opening

- Use key to unlock flap ①.
- Press both buttons (① and ②) and open flap.

#### Closing

- Press flap until it locks into place.
- Use key to lock flap ①.

# Hobby



### Exterior gas supply

At the customer's request, the motor home can be fitted with an exterior gas supply (2). Equipment that uses gas, such as a gas grill or a gas lamp, can be supplied from outside the motor home.

#### Opening

- Pull the cover plate (1) of the flap towards you.

#### Closing

- Press the cover plate (1) of the flap shut until you hear it lock into place.

**Hobby**



### Fresh water filler neck

#### Opening

- Use key to unlock ①.
- Turn lid ② firmly and remove.

#### Closing

- Insert lid ② and turn it closed.
- Use key to lock ①.



### Tank filler cap

The tank filler cap is located behind the driver's door in the lower section of the B-pillar behind a flap.

#### Opening

- Pull the flap open by inserting your finger into the convex opening ① and pulling it outwards.

#### Closing

- Push the flap until it locks.



Please refer to the separate operating instructions from Ford for information on how to operate the petrol cap.

# Hobby



## 5.4 Roof rail

### The following applies when loading the roof rail:

- Only store light items of luggage on the roof.
- Lash the roof load securely and ensure that it cannot slip or fall off.
- Do not overload the roof! The heavier the roof load, the worse the vehicle's performance.



The maximum overall load is 50 kg.

- Observe the maximum permissible axle loads when loading.
- Add the measurements of the roof load to the height of the vehicle.
- Place a note with the overall height in a visible position in the driver's cabin to avoid having to calculate it when passing under bridges or through archways.



Only transport roof loads using an additional, suitable roof rack.

# Hobby



### 5.5 Bicycle carrier

The motor home's handling when driving is significantly different when the bicycle carrier is in use. The driving speed should be adjusted accordingly to take this into consideration:

- Even if loading is perfect the critical speed is dramatically reduced.
- The driver is responsible for the secure fastening of the bicycles. Even when unloaded and folded up the carrier must be secured using the clips provided.
- Ensure that the existing lighting equipment is not completely or partially obscured by any loads.

## Hobby



The maximum permissible loads for bicycle carriers are 50 kg (for partly integrated models) and 60 kg (for alcoves), respectively.

### 5.6 Load carrier

As an optional extra your motor home can be fitted with a load carrier equipped with an attachment kit for securing a motorcycle or a motor scooter. The driver is responsible for the safe and stable fastening of the load.



- The maximum load capacity is 130 kg.
- Never exceed the permissible rear axle load.
- The load carrier reduces the rear ramp angle of the vehicle. When driving over uneven surfaces the carrier can touch the ground.
- When the load carrier is fully loaded the rear axle is subject to an additional load and the front axle is unloaded. This can result in significant changes in the motor home's handling, steering and braking performance.
- The rear number plate must be centrally mounted between the load carrier's number plate lights.
- Please note, when the load carrier is in use it is forbidden to use any existing towing fixture which may still be accessible simultaneously.



The load carrier can be fitted with special kits, e.g. for bicycles, luggage boxes or similar. Only SAWIKO mounting adapters are permitted for use; if other makes are used all guarantee claims will be forfeit.



### 5.7 Sun awning

As an optional extra your motor home can be fitted with a sun awning. Depending on the model the awning is either integrated into the lipping or attached to one of the side walls.



- An awning offers protection from the sun, not against the elements.
- Do not place people or obstacles in the extension/retraction area of the awning.
- The awning winding mechanism is fitted with a mechanical block control to limit the extent to which it can be extended. Never attempt to exceed the block control by force.
- Always support the awning with the integrated struts when extended.
- The awning must always be completely retracted and secured before driving.

**Hobby**

### Extending

- Insert the hook on the crank into the grommet on the winding mechanism.
- Hold the crank with one hand on the upper twist grip and the other on the lower twist grip. During the operating procedure gently pull the crank towards you and hold it as vertically in the grommet as possible.
- Turn the crank clockwise until the awning has been extended to the desired position.
- Remove the crank.
- Unfold the telescopic rods on the inside of the drop tube and use them to support the awning.

### Retracting

- Retract the telescopic rods, fold them up and secure them.
- Insert the hook on the crank into the grommet on the winding mechanism.
- Turn the crank anti-clockwise until the awning has been fully retracted and is secured.
- Remove the crank and store it in the vehicle.



If the canvas is slack when extended, retract the awning until the canvas is tightly stretched again.

## Hobby

## Hobby



## Chapter 6: Interior Structure

### 6.1 Opening and closing doors and flaps

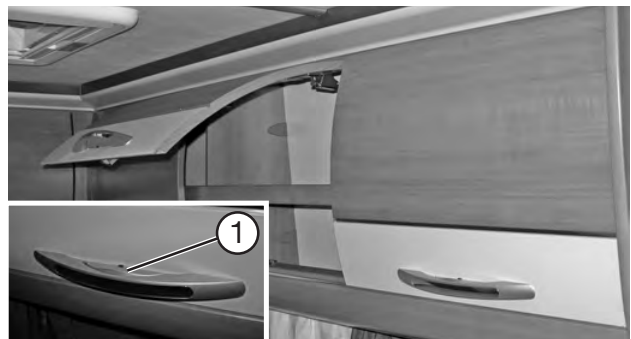

#### Stowage and kitchen wall cabinets

##### To open

- Press the pushbutton ① to unlock the flap.
- Pull on the handle until the flap opens.

##### To close

- Use the handle to press the flap shut until you can feel it close and lock.

**Hobby**



### Front stowage cabinets

#### To open

- Pull on the handle and swing the flap up.

#### To close

- Use the handle to press the flap shut until you can feel it lock into place.



Store only light objects in the upper stowage cabinets.



### Furniture doors with handle

#### Bath room door

- Push the handle to open and shut the door.

**Hobby**



### Furniture doors with turning knob

#### Wardrobes

- Turn the knob to open or shut the door.

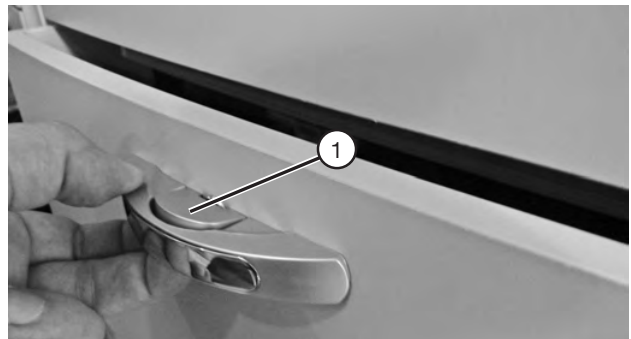

### Kitchen pull-out

#### To open

- Press the push-button ① to unlock the pull-out.
- Pull on the handle until the pull-out opens.

#### To close

- Use the handle to press the flap shut until you can feel it lock into place.

**Hobby**



### Doors with snap locks

**Kitchen wall cupboards, shoe cupboard**

#### Opening

- Briefly push the door handle until it snaps open.
- Open the door.

#### Closing

- Push the door handle until the lock snaps into place.

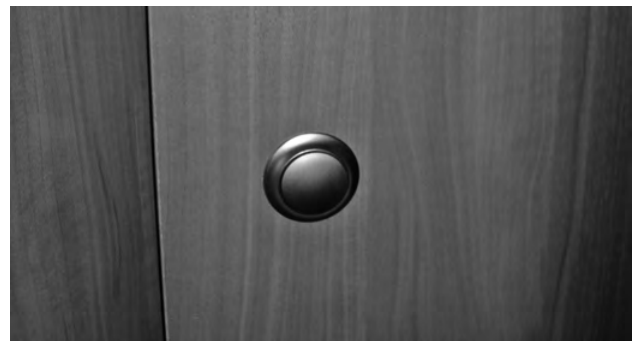

### Doors with push locks

**Refuse cupboard**

#### Opening

- Depress the push lock until the knob pops out.
- Carefully pull the knob and open the door.

#### Closing

- Push the door closed using the knob.
- Depress the push lock until the knob locks into place and the door is fastened.

**Hobby**



### Bar in the entrance area (layout/model-specific)

#### To open

- Pull on the handle and swing the door outwards.

#### To close

- Use the handle to press the flap shut until you can feel it lock into place.



### Sliding doors

#### Cupboard under the bed, washroom door

#### Opening

- Grasp sliding doors by the centre bar and push them both outwards.

#### Closing

- Grasp the doors by the centre bar and push them shut until they meet in the middle.

**Hobby**



## 6.2 Television holder for flat-screen monitor

To unlock, press in on the metal rail ①. Then extend the TV mount. 230 V power sockets and an aerial socket for the TV and/or receiver are located directly adjacent to the holder.



Lock the media unit or TV holder before driving.

**Hobby**

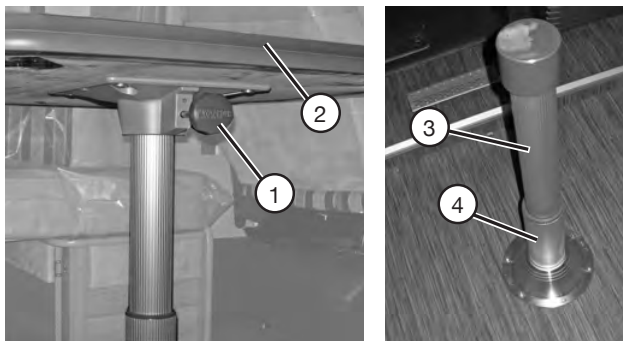

### 6.3 Tables

#### Pillared table

When lowered, the pillared table can also be used as a base frame for the bed.

#### To lower

- Lock the swivel lock on the table top by firmly tightening the knurled wheel ②.
- Pull the table top off by pulling it straight up.
- Pull the middle section of the pillar ③ off the foot ④ and remove it.
- Place the table top on the foot ④.

## Hobby

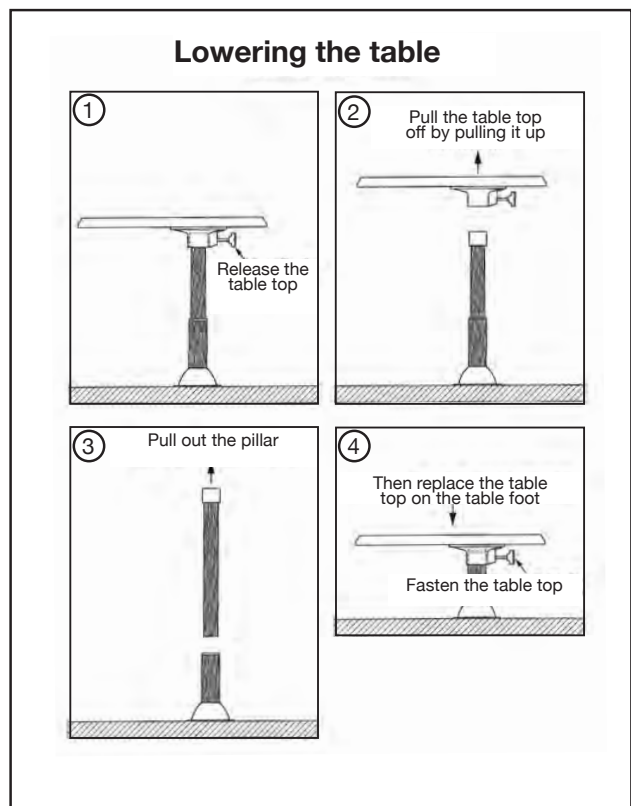

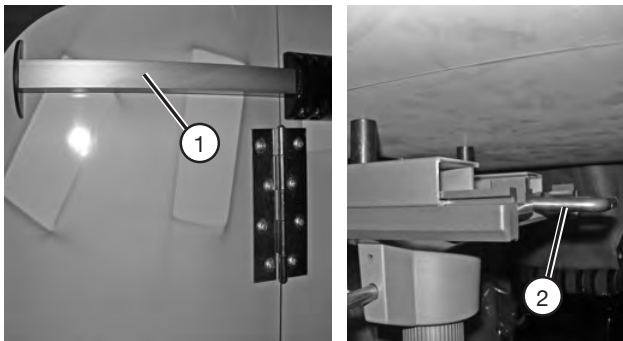

**Please note:**

- To ensure that it is easier to pass through to the driver's cab, one of the table's longitudinal sides can be folded down using latch ①.
- The table pillar in model T 600 FC allows you to shift the table top somewhat by pulling on clamp ② located underneath the table top. This gives you easier passage to the driver's cab.

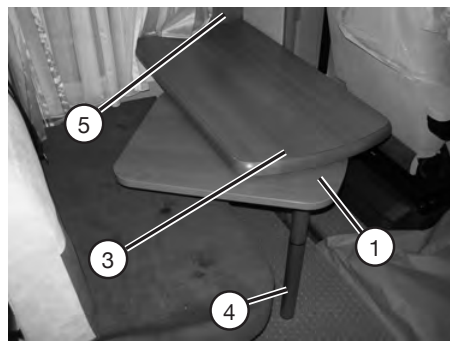

**Hanging table**

When lowered, the hanging table can be used as a base frame for the bed.

**To lower**

- Fully retract the lower, pivotable table top ① and use the locking pin ② to lock it.
- Raise the front end of the table top ③ by approx. 30°.
- Pull down the lower section of the table foot ④ and remove it.
- Pull the table top out of the upper wall bracket ⑤.
- Raise the front end of the table top by approx. 30° and hook it into the lower wall bracket ⑥.

**Hobby**



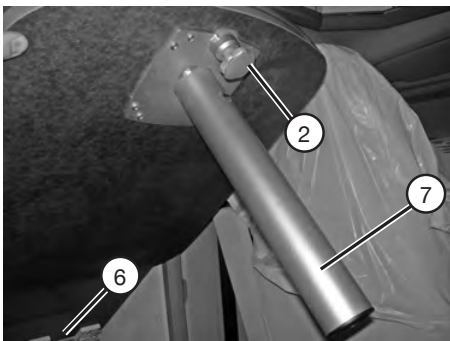

- Place the shortened supporting leg ⑦ at the front edge of the table top on the floor.

**To swivel out**

- Pull the locking pin ②.
- Swivel the lower table top ① to the desired position.

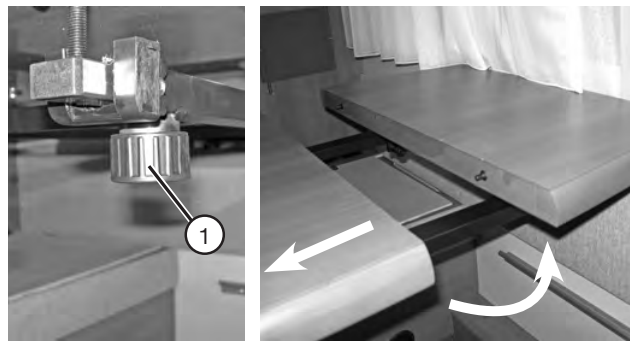

**Table extension**

- Turn the wheel ① under the table until the table is loose.
- Lift the table slightly and pull it out until the extra leaf is fully visible.
- Swing the leaf upwards towards the side wall.

**Hobby**

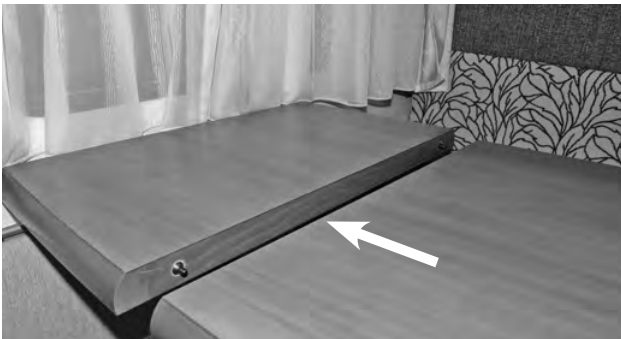

- Push the table towards the leaf and place them in the appropriate openings.

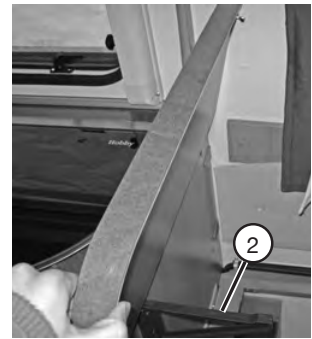
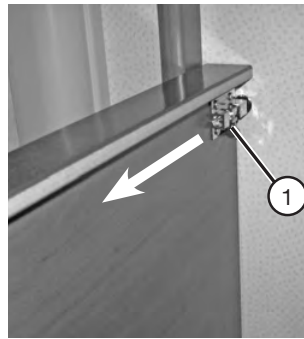

### Kitchen extension

- Swing the locking mechanism ① upwards and pull it back.
- Swivel out the extending support ②.
- Fold down the kitchen extension.

**Hobby**



### Lowering the table in the centre seating arrangement

- Push the switch ① on the table leg up.
- Fold in the lower part of the table leg until you feel it click into place.
- Unhinge the table and hook it to the lower fastening.

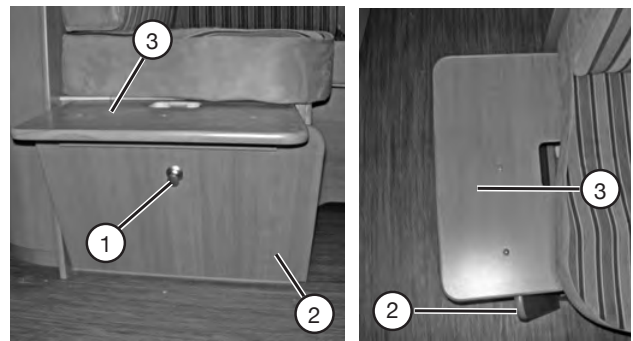

### 6.4 Bed conversion

The seating arrangements can be converted to comfortable beds.

#### Conversion

- Remove the seat and back cushions.
- Lower the table.
- Undo the lock ① on the bed expansion.
- Place the outer plank ② of the bed expansion on the floor.
- Raise the inner plank ③ approx. 15° above the horizontal position.
- Wedge the outer plank ② in a 45° angle (approx.) beneath the inner plank ③ to support it.
- Place the cushions on the bed according to the following diagrams.

**Hobby**

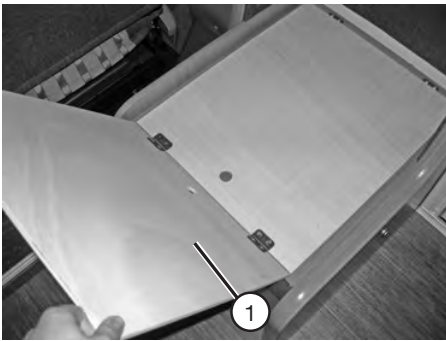

### Converting the Transverse Seat

In order to use the additional bed in the rear, the transverse seat must be converted.

#### Conversion

- Remove the seat and back cushions.
- Lower the pillared table.
- Fold the cushion ① cover forward by 180° and place it on the pillared table.

# Hobby

**6.5 Cushion arrangements**  
**Rearranging the cushions**  
**T500 FSC Van Classic**  
**T500 GFSC Van Classic**

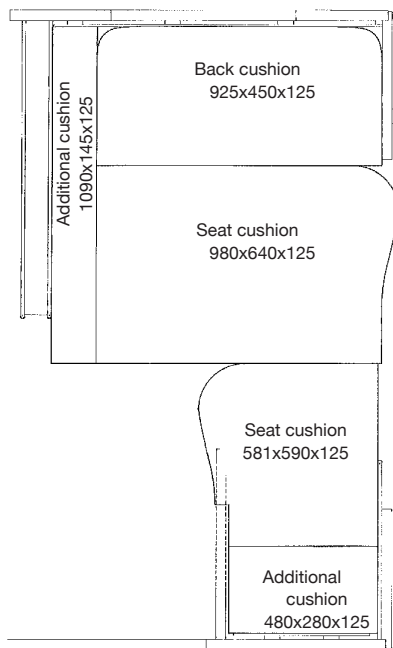

**Rearranging the cushions**  
**T500 GESCr Van Exclusive**

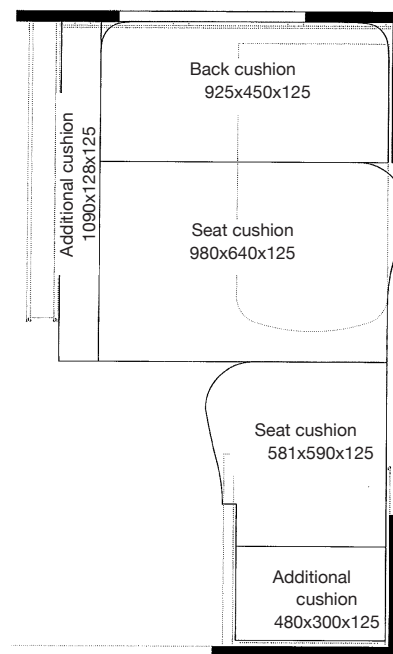

**Hobby**

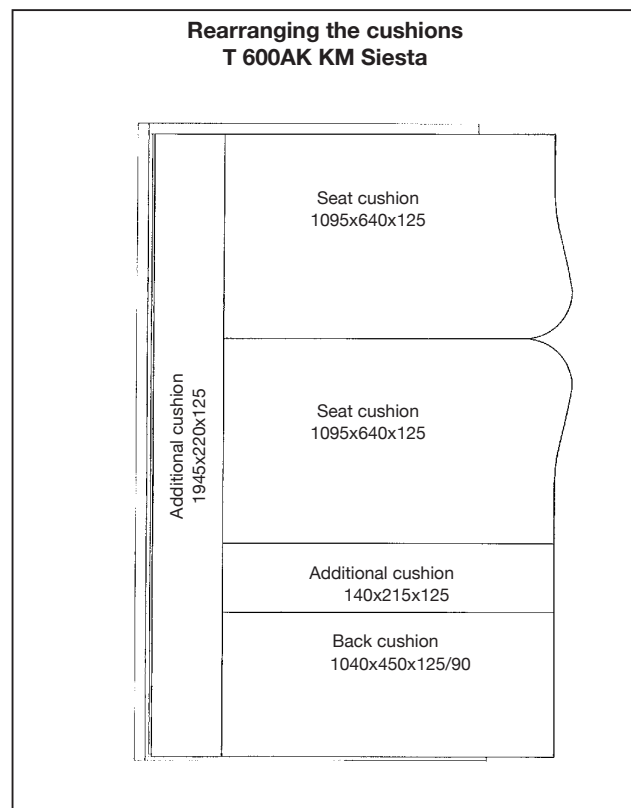
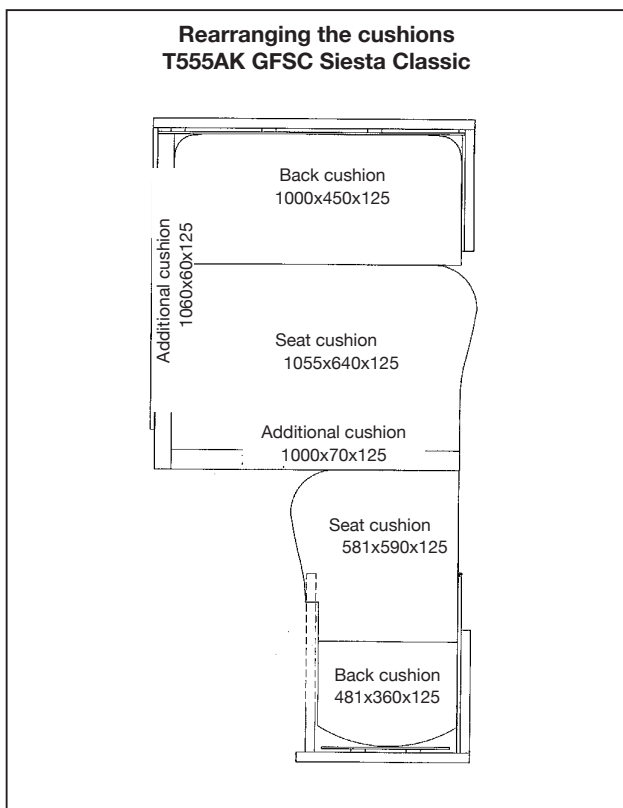

**Hobby**

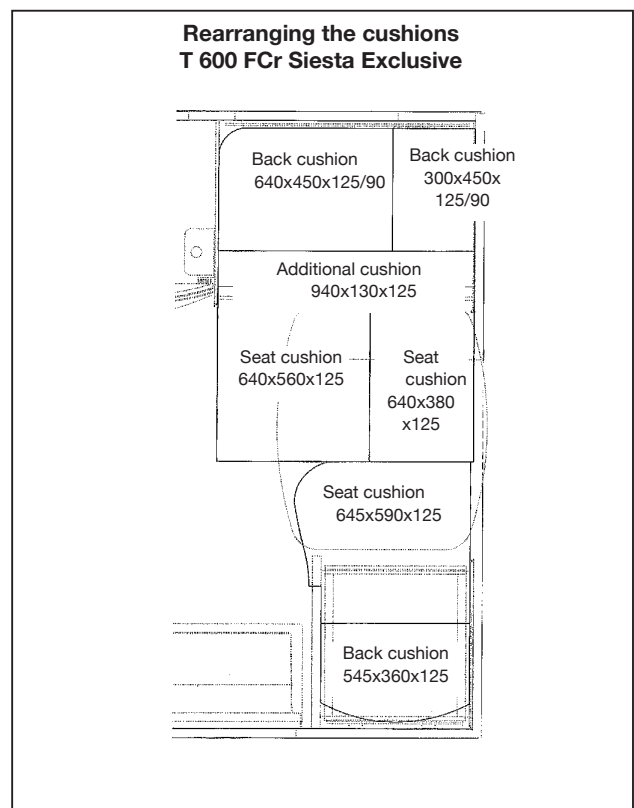
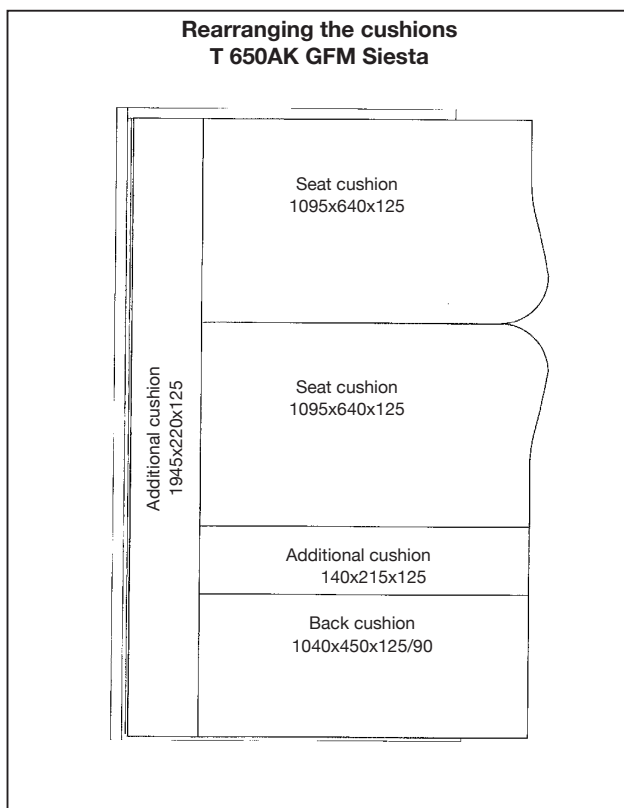

**Hobby**

**Rearranging the cushions  
T 650 FLCr (F) Siesta Exclusive**

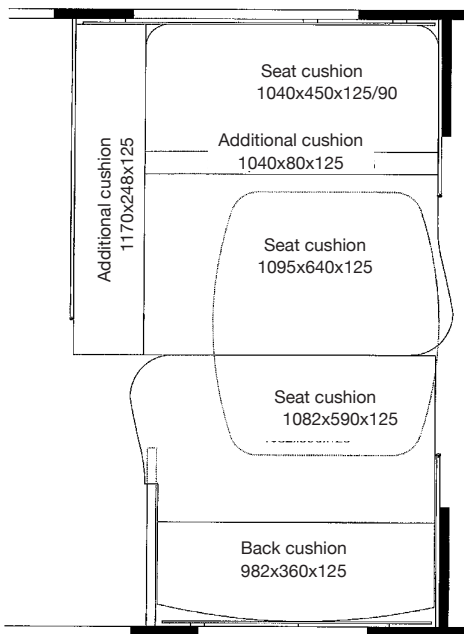

**Rearranging the cushions  
T 650 ESCr (H) Siesta Exclusive**

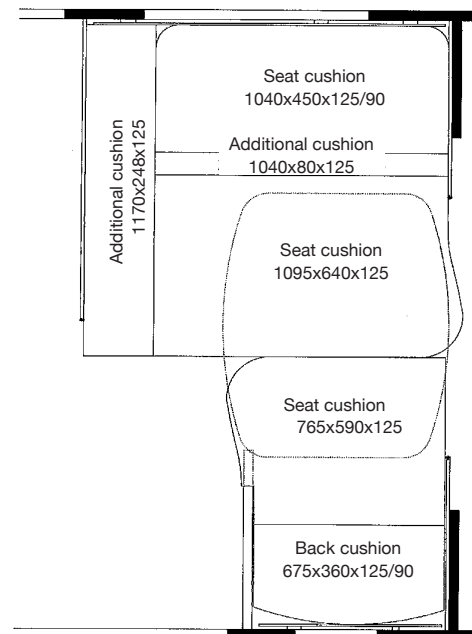

**Hobby**



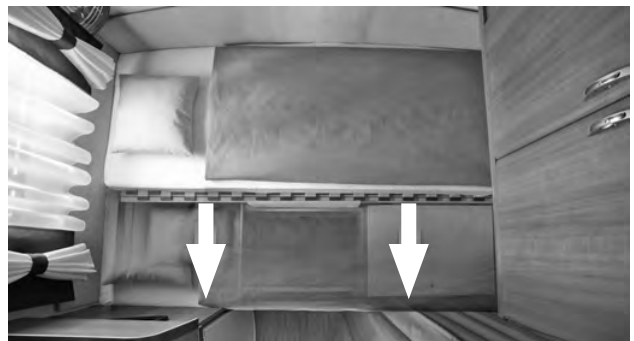

### Widening the beds

In the Van Exclusive L model, the two single beds above the rear garage can be widened and/or joined by folding out an additional plank.

- Open the flap ① under the additional plank and take out the access ladder.
- Fold the additional plank ② forward and hook the access ladder securely into the appropriate holes.
- Place the two additional cushions on the surface.

### Retractable bed

- Take the mattress out from under the slatted frame. Pull the slatted frame out and place the mattress(es) on it.

## Hobby

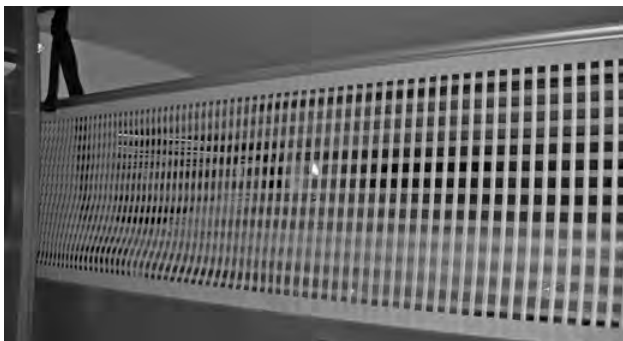

### 6.6 Alcoves/queen-size bed, rear, crossways

Parents are responsible for ensuring that small children do not fall out of upper berths. If there are small children in the alcove, upper children's bed or elevated bed at the rear end of the mobile home, the safety nets must be pulled up and fitted in the brackets as a protection against falling out.



The base of the alcove can be folded up hydraulically to give you a more comfortable sitting position. Use the mounted handle to push it up or pull it down.



If you have put small children in the upper berths, secure them against the danger of falling out!

**Hobby**



### Access ladder for bed in the external storage locker/alcove

Hook the ladder securely into the appropriate holder. Ensure that the ladder cannot slip.

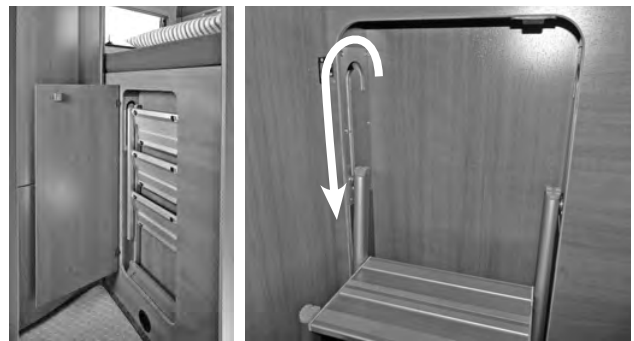

### Foldaway bed ladder

- Use the push lock to open the door.
- Pull the bed ladder out along the rail guide; the steps will simultaneously slide out to their correct position.

**Hobby**



## 6.7 Windows

### Knockout windows with locking hooks

#### Opening

- Press the knob of the bolts and turn them to a vertical position.
- Press the window outwards until you hear a click. The window will automatically remain in this position. The width of the opening is adjustable in several stages.

#### Closing

- Raise the window slightly so that the hook unlocks.
- Close the window.
- Press the knob of the bolts and turn them to a horizontal position.



### Sunshade/insect screen

The sunshades/insect screens are integrated in the window frames. They can be used separately.

#### Insect screen

##### To close

- Pull down on the connection latch until you feel the screen click into place

##### To open

- Pull the connection latch on the screen slightly downward until the screen is released.
- Let the insect screen slowly slide upward.

**Hobby**



### Sunshade

#### To close

- Move the sunshade slowly and evenly to the desired position.

#### To open

- Push the shade up slowly and evenly.



### Skylight

The skylight cannot be opened. It is fitted with an integral dimming shade which can be drawn as required by pulling it.

# Hobby

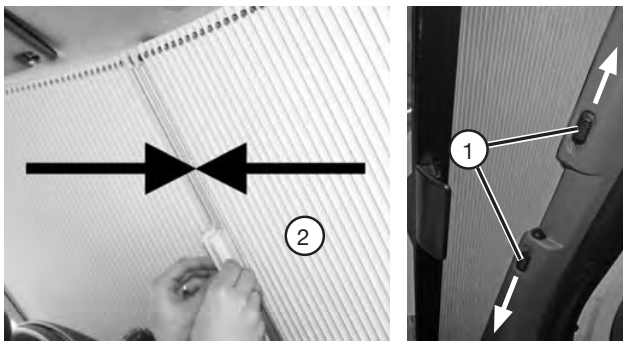

### 6.8 Dimming system for driver's cabin

The dimming shades may only be drawn when the vehicle is standing and the motor has been turned off. Before starting your drive, you must fold up the entire system and lock it.

Open the dimming system whenever you are not using your motor home, as otherwise it will be permanently damaged by the effects of heat and UV rays.



The dimming system may never be used as a sunshade or closed while driving.

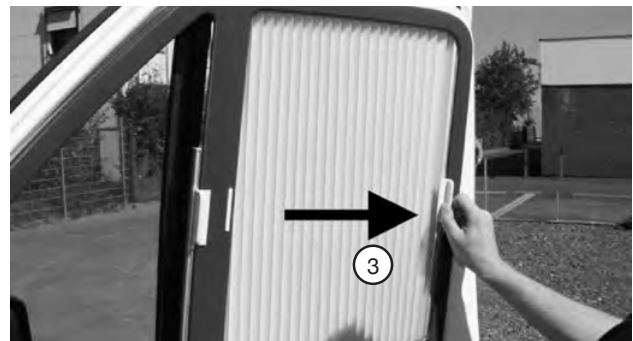

#### Front system

- To open the locking mechanism, push the locks ① outward.
- Press the clasp ② together in the middle. The magnetic lock will automatically lock.

#### Side system

- Draw the clasp ③ across to the rabbet. The magnetic lock will automatically lock.

**Hobby**

## 6.9 Skylight

### Safety instructions



- Never open the skylight in strong winds/rain/hail, etc. or if the temperature outside is below -20°C!
- Remove snow, ice or excessive dirt before opening. Ensure there is sufficient room before opening the skylight under trees, in garages, etc.
- Do not use force to open the roof skylight when covered by ice or snow as this could break the hinges and opening mechanism.
- Do not stand on the skylight.
- Close and bolt the skylight before driving. Open the insect screen and pleated material (resting position).
- If the sunlight is very strong, pull the sunshade only 3/4 closed, otherwise there is a danger of heat build-up.



The vents for ventilation must always remain open! Never shut or cover up these vents!



Before driving, ensure that the skylight is securely bolted.



### Small roof bonnet

#### Opening



Before opening the skylight, check that the outside area above the skylight is clear.

- There are three different positions for opening the skylight by turning the crank anti-clockwise. Press the locking button and open the skylight to the desired position by turning the crank before locking it into position. The maximum opening angle is 50°.

#### Closing

- Release the crank from the locking position and close the skylight. The skylight is automatically locked when it has been fully closed.

# Hobby



## Large roof bonnet

### Opening

- Turn the crank to its user position. By turning the crank clockwise, you can now open the skylight to the desired position. When the maximum opening angle of 60° has been reached you will feel resistance.

### Closing

- Turn the crank anti-clockwise until the skylight is closed and you can feel resistance. The crank can be folded back into the crank niche when the skylight is closed. To ensure safe closure the crank should be folded back into the crank niche. Check the skylight is closed by pushing against the glass with your hand.

## Dimming shade

Pull the handle of the shade to any desired position or until the latch locks into the handle of the insect screen.

## Insect screen

Push the clasp of the insect screen against the clasp of the shade until the latch locks into the clasp.

**Hobby**



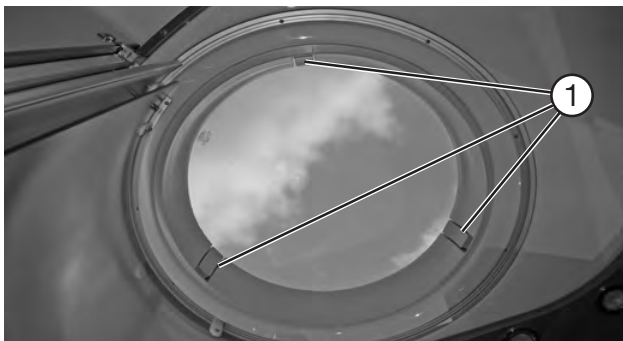

### Round roof light

**To open:**

- Pull the lower end of all three locking mechanisms ① towards the middle of the window and release them.
- Push the full surface of the roof bonnet up until it locks into place.

**To close:**

- Close the roof bonnet.
- Press the locking mechanisms ① firmly until they lock into place.

## Hobby



### 6.10 Seats in the driver's cabin



Please refer to the operating instructions of the basic vehicle for information on operating these.



- Before driving turn all swivelling seats in to face in the driving direction and lock them into place.
- Leave the seats locked to face in the driving direction while driving. Do not swivel them.
- When the vehicle is stationary: when swivelling the driver's seat make sure that the handbrake is not released by accident.

**Swivelling seats**

- Put the armrests up.
- Move the seat to the middle position.
- Release the lever to swivel the seat. The seat will be released from the locking position.
- Push the seat belt buckle down to avoid damaging it.
- Swivel the seat to the desired position.

**Hobby**



## 6.11 Construction of the seats

### Cushion fastenings

The seat and back cushions are held in place by an anti-slip mat.



Ensure that the seat cushions and backrests are fastened securely and correctly.

### Adjusting the height of the headrests

- Grasp the cushion on the headrest and push it to the desired position.

**Hobby**

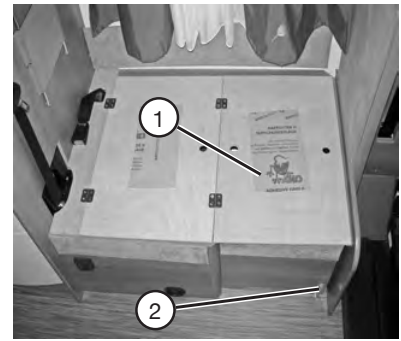
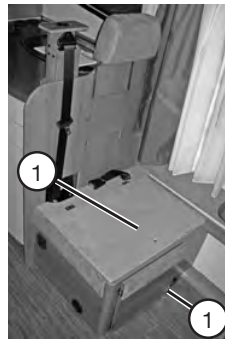

### Converting the L-shaped seating arrangement / individual seat

If you wish to use the outer seat in models with an L-shaped seating arrangement or the individual seat in the T 600 FC model, you must convert these before you start to drive.

#### Conversion

- Remove the seat and back cushions.
- Fold back cushion cover ① by 180° and place it on the crossbench.
- Open locking bolt ②, swing the supporting wall out by 90° and then shut locking bolt ②.
- Replace the seat and back cushions on the crossbench. Sort the seat belts and buckles.

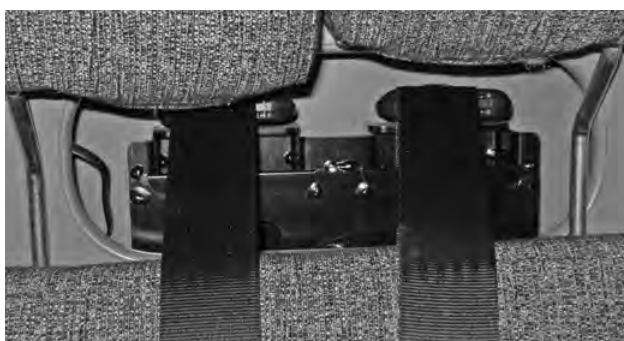

### 6.12 Seatbelts in the caravan

The centre seating arrangements are fitted with safety belts; as an optional feature, they can also be fitted with additional safety belts.



Please note the overview of the seating arrangements for your vehicle. Certain seats may not be used while driving!

#### Buckling the seatbelt

Do not twist the seatbelt.

- Grasp the tongue and insert it in the lock of the seatbelt until you hear it snap shut.

- Guide the upper part of the seatbelt over your shoulder and diagonally across your chest.
- The lower part of the seatbelt fits across your hips.

#### Unbuckling the seatbelt

- Press the button on the lock of the seatbelt to unlock the tongue.



- Fasten seat belts before driving and keep them fastened while driving.
- Do not damage or jam the seatbelts. Damaged seatbelts should be replaced by an authorised workshop.
- Do not alter the seatbelt fixings; the automatic retraction system or the buckles.
- Only use each seatbelt for one adult. Do not fasten objects and people using only one seatbelt.
- Seatbelts alone are not suitable for persons under 150 cm tall. In such cases use additional restraining equipment.
- Replace seatbelts after an accident.
- Do not twist the seatbelt; it should fit closely to your body.

**Hobby**

### 6.13 Overview of the seating arrangements

**T500 GFSC Van Classic**

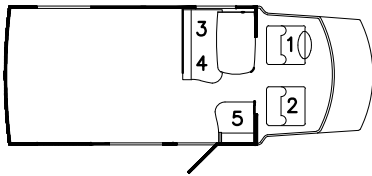

Seats 1 - 4: may be used while driving.  
Seat 5: must not be used while driving.

**T500 FSC Van Classic**

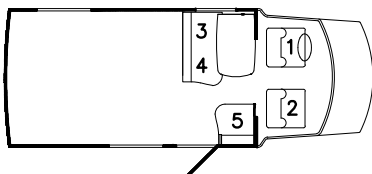

Seats 1 - 4: may be used while driving.  
Seat 5: must not be used while driving.

**TL 500 GESC Van Exclusive**

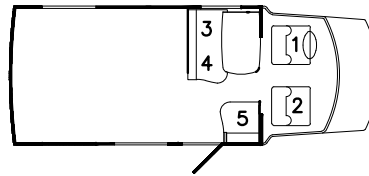

Seats 1 - 4: may be used while driving.  
Seat 5: must not be used while driving.

**T 600 FC Siesta Exclusive**

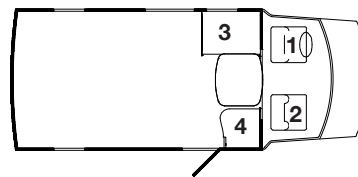

Seats 1 - 3: may be used while driving.  
Seat 4: must not be used while driving.

# Hobby

**T 650 FLCr Siesta Exclusive**

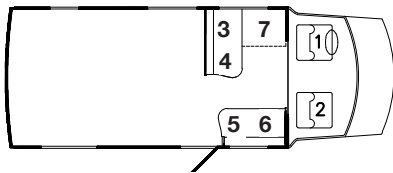

Seats 1 - 4: may be used while driving.  
 Seats 5 - 7: must not be used while driving.

**T 650 ESCr Siesta Exclusive**

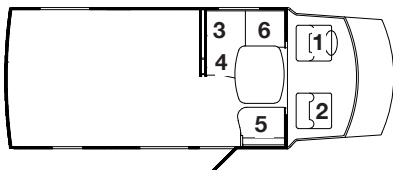

Seats 1 - 4: may be used while driving.  
 Seats 5 - 6: must not be used while driving.

**T 555 AK GFSC Siesta**

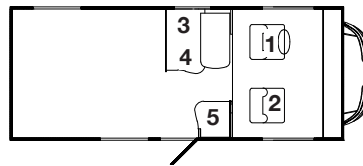

Seats 1 - 4: may be used while driving.  
 Seat 5: must not be used while driving.

**T 600 AK KM Siesta**

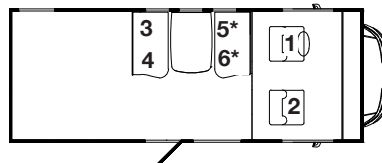

Seats 1 - 4: may be used while driving.

\*Seats 5 - 6: Only for the optional additional belt rack. If the additional belt rack has not been fitted as an option, this seat may not be used while driving.

**Hobby**

### T650 AK GFM Siesta

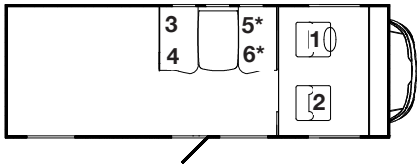

Seats 1 - 4: may be used while driving.

\*Seats 5 - 6: Only for the optional additional belt rack. If the additional belt rack has not been fitted as an option, this seat may not be used while driving.

# Hobby

### 6.14 Overview of day and night positions

T 500 FSC Van

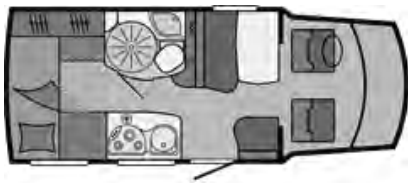

T 500 GFSC Van

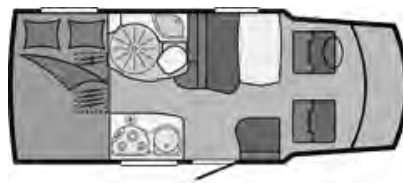

Day position

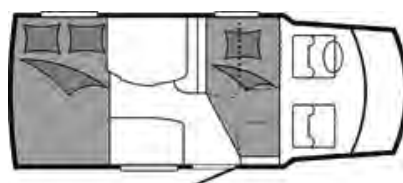
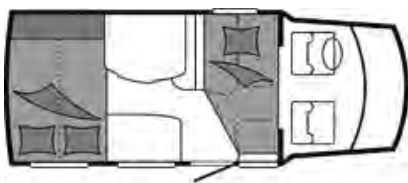

Night position

**Hobby**



TL 500 GESC Van Exclusive



T 555 AK GFSC Siesta

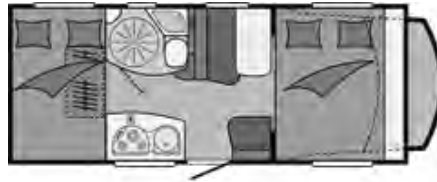

Day position

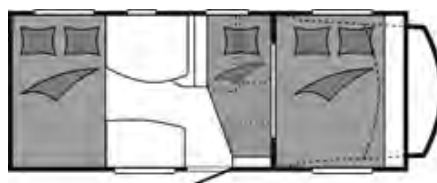

Night position

**Hobby**

T 600 AK KM Siesta

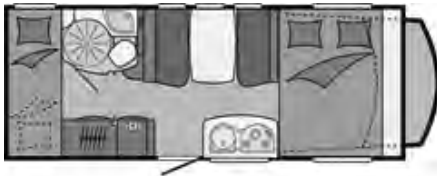

Day position

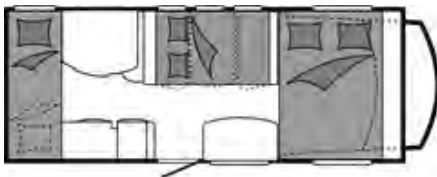

Night position

T 650 AK GFM Siesta

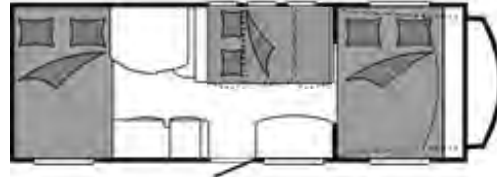
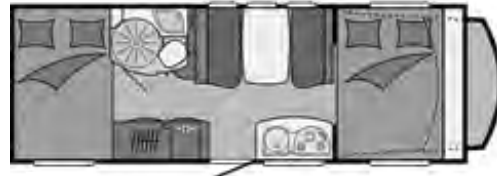

**Hobby**

T 600 FC Siesta Exclusive



T 650 FLC Siesta Exclusive



Day position

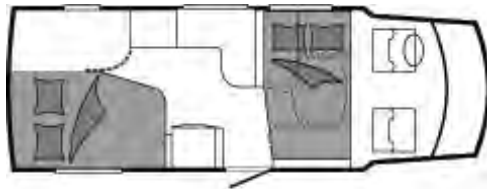
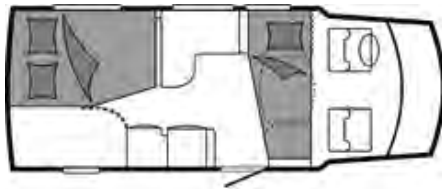

Night position

**Hobby**

## Hobby

## Chapter 7: Electrical Installations

### 7.1 Safety instructions

**The following must be observed:**

- Do not remove the signs on electrical components giving safety instructions or danger warnings.
- Do not use the installation compartments for the caravan battery, on-board control panel, battery charger and 230 V connector box as additional storage room.
- Smoking and naked flame are forbidden when checking electrical equipment.
- Only authorised and experienced workshops may carry out electrical repairs.
- Inexpert handling of the vehicle's electrical system may endanger your own life as well as that of others.
- Use only weatherproof, 3-wired extension cable and shock-proof plug or CEE plug and coupler when hooking up to an external 230 V network.

### 7.2 Elements of the electrical system

The electric power supply is provided via the HOBBY on-board control panel in connection with an automatic battery charger.

## Hobby

#### Main elements of the electrical system

- CONTROL PANEL – Controls the electrical consumers and shows their status.
- 12V DISTRIBUTION MODULE - Master relay, battery parallel relay (12V - 70A), refrigerator relay, pump relay, charging device, safety fuses, undervoltage protection.
- BATTERY CHARGING DEVICE - Charges the battery in buffer operation.
- PROBE WITH RODS - Measures the contents of the fresh water tank.
- PROBE WITH SCREWS - LED display shows when waste water tank is full.
- MODULAR BATTERY WITH CIRCUIT BREAKER - Supplies all consumers.
- VEHICLE BATTERY
- GENERATOR - Loads both the vehicle and consumer batteries at the same time.
- 230V MAIN SWITCH - Supplies and protects the 230V consumers.
- 50A FUSES VEHICLE/ and CONSUMER BATTERIES

## Advice and instructions

### Important

- Any changes to the electrical installations may only be carried out by a professional electrician.
- Open battery circuit breaker and switch off 230V mains before carrying out maintenance work.

### Batteries

- Please observe the battery manufacturer's operating instructions.
- The acid in the battery is poisonous and corrosive. Avoid contact with eyes and skin.
- The completely discharged battery must be recharged for at least 10 hours. The battery may be damaged if it has been discharged for more than 8 weeks.
- Avoid total discharge since this significantly reduces the performance capacity and service life of the batteries.
- Check the level of the battery fluid regularly (acid batteries); gel batteries require no maintenance, but must be continuously recharged.
- Check that the clamps have been properly fitted and, if necessary, remove any layers of oxide.
- Unclamp the minus pole if the ancillary battery is not being used for a longer period of time (more than 1-2 months). Even if the main switch of the battery has been interrupted, the battery may be recharged by the charger. (Conservation charging)

- Should the consumer battery be removed, isolate the plus pole (to prevent short circuits when turning on the motor).
- Do not plug up the ventilation and ensure that you have adequate ventilation.

### Battery charger

- The charger's capacity is 220 W.
- The charger functions in accordance with IU0U1 charging technology.
- In the case of misuse the guarantee and manufacturer's liability will no longer apply.

### Tank probes

- To avoid incrustations, particularly in the waste water tank, never let the water in the tanks stand for too long. Flush the tanks regularly.

### 230V main switch

- To switch off the power supply for the entire system set the main switch to "0"(OFF).
- Only connect and disconnect the system to the 230V external mains when the main switch is turned off.

### Fuses

- Only replace defective fuses after the cause of the defect has been remedied by a professional electrician.
- The new fuse must have the same amperage as the old one.

**Hobby**

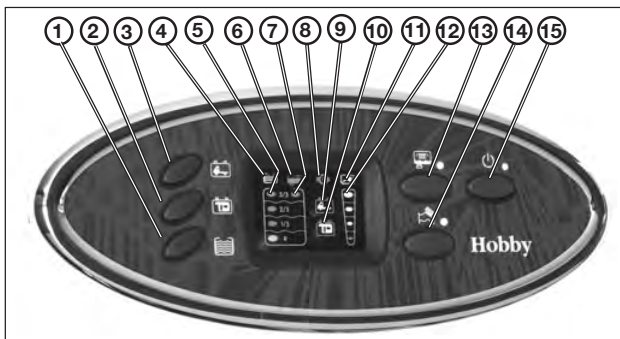

## Control panel

### Description

- ① Button for monitoring fresh water tank.
- ② Button for monitoring consumer battery (B2).
- ③ Button for monitoring vehicle battery (B1).
- ④ LED indicates test in fresh water tank; flashing indicates empty tank.
- ⑤ LEDs signal level of fresh water tank.
- ⑥ LED indicates test in waste water tank; flashing indicates full tank.
- ⑦ Flashing LED indicates full waste water tank; LED 6 also indicates alarm.

## Hobby

- ⑧ Indicates that generator is charging vehicle and consumer batteries.
- ⑨ LED indicates test of vehicle battery; flashing indicates empty battery.
- ⑩ LED indicates test of consumer battery; flashing indicates empty battery.
- ⑪ LED indicates that 230V mains is connected.
- ⑫ LED voltmeter for monitoring voltage of vehicle and consumer batteries.
- ⑬ Control switch for waste water tank resistance; dependent on main switch and functions when motor is switched on or 230V mains is connected.
- ⑭ Switch for water pump that operates pump relay; dependent on main switch.
- ⑮ Main switch for consumers; flashing LED indicates that consumer battery is almost empty and protection against total discharge will soon be activated.

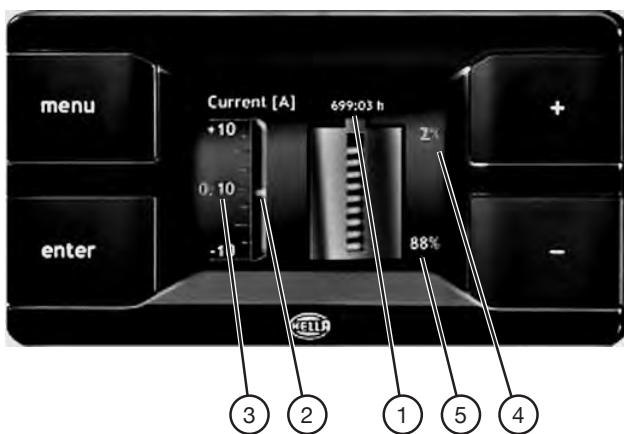

### Intelligent Battery Sensor (IBS)

As an optional feature, your vehicle is equipped with a battery sensor. The IBS control measures the available capacity of the battery and also indicates battery ageing.

#### Legend

##### ① DOD display

Shows the remaining amount of time for use if current amount of use is continued..

##### ② Electric power display

Red = discharge

Green = charge

##### ③ Electricity as a numerical value

Example: Current discharge: 0.1 A.

##### ④ Battery ageing

(SOH = State of Health)

Example: The original capacity of the battery has already been reduced by 2%.

##### ⑤ State of charge

(SOC = State of Charge)

Actual state of charge of the battery

Example: SOC: 88%.

**Hobby**



## 07-5 | Electrical Installations

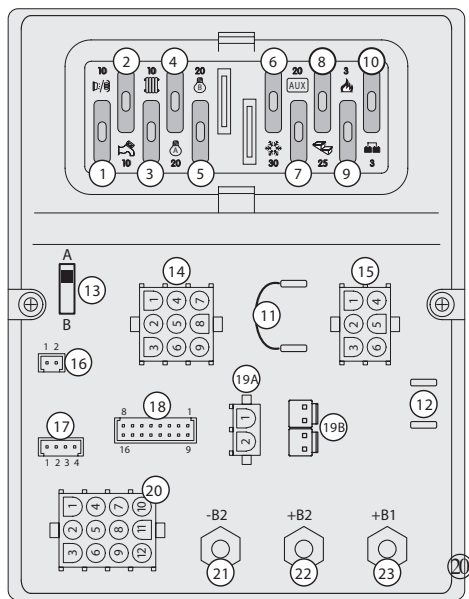

### Distribution module

#### Fuses

- ① 10A fuse for supply of the front tent light
- ② 10A fuse for supply of the water pump

### Hobby

- ③ 10A fuse for supply of the heating/boiler
- ④ 20A fuse for the lights
- ⑤ 20A fuse for the lights
- ⑥ 30A fuse for supply of the 12V AES absorber refrigerator
- ⑦ 20A fuse for the aux supply (solar charger controller)
- ⑧ 25A fuses for supply of the electric step
- ⑨ 3A fuse
- ⑩ 3A fuse
- ⑪ Bridge circuit
- ⑫ Simulated D+ alternator output for electric step and refrigerator
- ⑬ Changeover switch for connecting the control panel:  
A: PC100 HB ; PC 200 HB  
B: PC100 HB T
- ⑭ Electrical device connection A
- ⑮ Electrical device connection B
- ⑯ Waste water tank sensor connection
- ⑰ Fresh water tank sensor connection
- ⑱ Control panel connection
- ⑲ A Signal input ignition - variation A
- ⑲ B Signal input ignition - variation B
- ⑳ Ground connection for electrical devices
- ㉑ Connection for negative pole for modular battery
- ㉒ Connection for positive pole for modular battery
- ㉓ Connection for positive pole for vehicle battery

### 7.3 Electric power supply

Your motor home has the following connections for electric power supply:

- electric mains (a.c. voltage 230 V)
- caravan battery (d.c. voltage 12 V)

#### Electric power supply from the electric mains

The 230 V system is protected by a 2-pole circuit breaker with 16 A. The circuit breaker is located behind the driver's seat.

Should there be a malfunction, the passenger circuit breaker opens the entire 230 V circuit. In most cases, such a malfunction is caused by a defect piece of electric equipment or a defect in its supply line.

- Repair the defect before switching the circuit breaker on again.
- If the defect cannot be repaired, consult an experienced electrician.

#### The following applies for the electric mains:

- the power supply lead may not be longer than 25 m



If you are using a cable drum without protection against overheating, the electric cable must be completely unwound from the cable drum.

- Use only plugs and cables that meet CEE standards.
- First, make the connection to the main socket of the vehicle.
- Then insert the other plug in the live socket.
- Follow this sequence in reverse when you pull out the plug.

**Hobby**

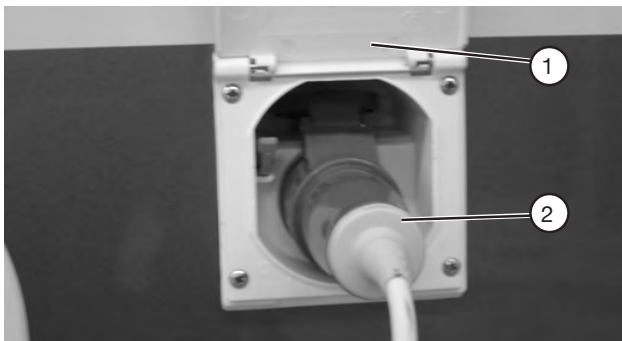

### Exterior socket

#### Opening

- Take hold of the bottom of the cover flap ① and pull it upwards.

#### Closing

- Remove CEE plug ②.
- Push cover flap ① down until you hear it lock into place.

**Hobby**

## 7.4 Function of the power generating unit

### Position of the battery charger

The charger is located under the passenger seat.

### Operation with 230V mains electricity

After the mains connection has been plugged in, both the modular and the vehicle battery will automatically be charged by the battery charger in the mobile home (even if the Control Panel has not been switched on).

### Charging procedure

The charger represents the current status of technology and charges in three phases in accordance with the so-called  $IU_0U_1$  curve. The charging period should be at least 12 hours.



Batteries do not respond well to cold temperatures; in such cases they do not supply electricity to the on-board circuit or absorb power from the charger. Therefore, when travelling in winter, the heating should be turned on before charging the batteries.



The battery voltage of both the motor battery and the ancillary battery can be checked continuously on the control panel.



The battery charger only works if the batteries have been inserted with their poles in the right direction.



The minimum charging period of 12 hours must be extended accordingly if equipment using 12V is switched on during charging.

### Total discharge protection

If the battery voltage of the ancillary battery sinks below 10.5 V a relay shuts down all equipment using power.



If the total discharge protection is activated turn off the 12V main switch to avoid an additional discharge of the ancillary battery.

## Function of the battery charger

### Protecting the device

If the battery charger should become hot because of high environmental temperatures or high charging currents, a built-in thermal switch turns off the battery charger until the temperature in the battery charger has dropped again.

### Check list

- Turn off the motor.
- Connect the battery charger to the mains supply.
- Switch on the 12V main switch.
- Turn off all equipment (also refrigerator) using 12V power.

The voltage of the caravan battery must rise to a maximum voltage of 14.4 V.

If this does not happen after using the built-in battery charger to charge the battery, check the following:

- Is the charger attached correctly to the power supply?
- Is the charger's mains fuse working properly?
- Is the charger's battery voltage over 3 volts?
- Are the ancillary battery's poles attached correctly?

**Hobby**

### Operation when the motor is running

As soon as the motor is running, a relay connects the starter battery and the caravan battery in parallel. The D+ signal sits close to the dynamo. Therefore, the dynamo charges both batteries. If the D+ signal no longer sits close to the dynamo, the two batteries will be separated from each other again. In this way, the starter battery cannot be discharged by equipment in the caravan.

The 12 V supply for the refrigerator only functions when you are driving. If the motor has stopped, the 12 V operation of the refrigerator is automatically turned off again.



To charge a discharged caravan battery optimally while driving, disconnect the 12 V operation of the refrigerator and turn off as much equipment as possible that uses 12 V.

### Checklist

- Turn off the motor.
- Switch on the 12 V master switch.
- Turn off all equipment that uses 12 V.
- Start the motor.

The voltage of the caravan battery must rise if

- the engine speed is above the idling speed,
- the vehicle's battery is not completely discharged.

If this does not happen after using the dynamo to charge the battery, check the following:

- Is the 50A fuse in the supply line to the ancillary battery near the motor battery functioning properly?
- Is the fuse distribution panel displaying the "Motor running" signal?

### Operation by means of a 12 V caravan battery

All of the equipment is automatically supplied from the caravan battery if the motor home is standing still without a 230 V mains supply and with its engine turned off. The 12 V master switch must be switched on.



The caravan battery should only be allowed to discharge to a voltage of 11 V. At this point, you should ensure that it is recharged from the dynamo or from public supply.

# Hobby

## 7.5 Caravan battery

### Location

- Under the passenger's seat or in a separate compartment which is accessible from the outside (SW has an additional battery).

### Features

- The battery does not require maintenance. It does not need to be refilled with water.
- The battery is closed off and cannot leak.
- The battery is cycle-proof, making it especially suitable for the supply of the board network. Several discharging/charging operations are possible.



Use only the same kind of batteries when exchanging the battery (same capacity and voltage, cycle-proof, maintenance-free and leakproof).

## Changing the battery

- Please do not smoke when changing the battery.
- Disconnect the connection to the 230 V network.
- Before disconnecting or connecting the battery switch off all equipment using 12V power.
- First, disconnect the negative (-) terminal.
- Then disconnect the positive (+) terminal.
- Remove the battery.
- Insert the new battery.
- Use the reverse sequence to connect the new battery.

**Hobby**



### Circuit breaker

To protect the modular battery from being exhaustively discharged when the mobile home is not being used, a circuit breaker ① has been installed, which is located underneath, directly on the back of the passenger seat. When the switch is opened, the modular battery is completely disconnected from the 12 V mains.



When the circuit breaker is open, the electrical input stage will **not** engage automatically.



### 7.6 Fuse protection of the electric system

#### Ancillary battery

Fuses are mainly protected by a 50 A safety fuse ①. This is located directly on the modular battery.

#### 12V circuits

Fuse protection is carried out by means of fuses on the 12V distribution module.

#### The following applies if one of the devices breaks down

- Check the fuse on the corresponding electric circuit.
- Replace the fuse.
- If the fuse blows again please contact your authorized Hobby dealer.

**Hobby**

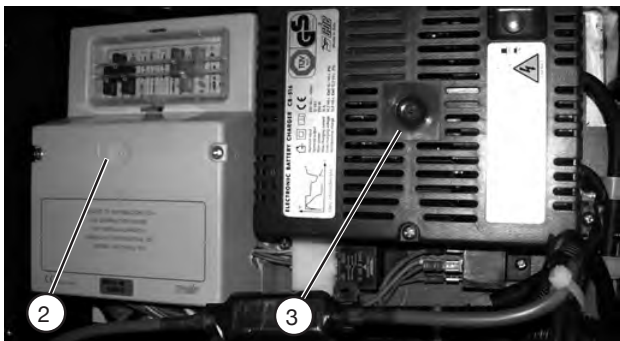

### Battery charger with a distribution module

The charger ③ and distribution module ② with integrated fuses are located in front of the modular battery under the passenger's seat.



### 7.7 Mobile navigation

As an optional feature, your mobile home can be equipped with a mobile navigation system and integrated rear view camera, which can be clipped into a special holder on the dashboard. It then functions immediately.

- Press the right switch ① forward.
- First remove the right-hand side of the sat-nav device, then the left-hand side.

**Hobby**





- Remove the device from the holder when you park your mobile home, as otherwise it will continue to use electricity and the starter battery might be discharged.
- Read the device manufacturer's operating instructions carefully before initial operation.



- Do not allow yourself to be distracted by this device as this may cause accidents.
- Never operate the device while driving.
- Check the display panel only when the traffic situation is safe for doing so.

## 7.8 Subsequently installed devices

Subsequently installed electronic devices that can be used while driving (e.g. mobile phones, wireless equipment, radios, cameras for driving in reverse, navigation equipment, or others) must meet all of the requirements for electromagnetic compatibility. Such equipment must have been approved in accordance with EU Guideline 72/245/EWG as it appears in version 95/54/EG, because otherwise it may cause interference with the electronic systems already installed in the motor home.

A CE mark is mandatory for devices that have been subsequently installed and which cannot be used while driving.

**Hobby**

**Hobby**

## Chapter 8: Water

### 8.1 General



- Always use water that is of drinkable quality when working with food. This also applies for washing your hands or objects that come into contact with food.
- In order to ensure excellent water quality, water should be taken directly from the public drinking water system.
- Garden hoses, watering cans and similar materials unsuitable for drinking water should never be used to fill the mobile system.
- If the mobile home has not been used for a longer period of time, the entire water system must be emptied completely.
- After longer periods of stagnation, the water system must be flushed thoroughly before being used. Should you discover impurities, the material should be disinfected using suitable agents that have been approved for such measures.

### 8.2 Water supply



The water supply system corresponds to the current status of technology as per 10/2009 [Directive 2002/72/EC].

The motor home is equipped with a fixed fresh water tank. An electric water pump pumps the water to the individual water outlets. When a tap is turned on the pump is automatically activated and pumps water to the relevant outlet. The waste water tank collects the dirty waste water. The water levels in the fresh water and waste water tanks can be checked on the control panel display.

The fresh water tank is filled using the filler neck on the side wall. The fresh water filler neck has a blue cap ① and a tap symbol on the bottom edge of the frame. The filler cap ① can be opened or closed using the ancillary key.

#### Filling the system

- Close all outlets and valves.
- Open the protective cover ② of the filler neck by pulling it.
- Unlock and open the filler cap ①.
- Fill the tank with drinking water.
- Switch on the 12V main switch.
- If applicable turn on the water pump at the control panel.

# Hobby

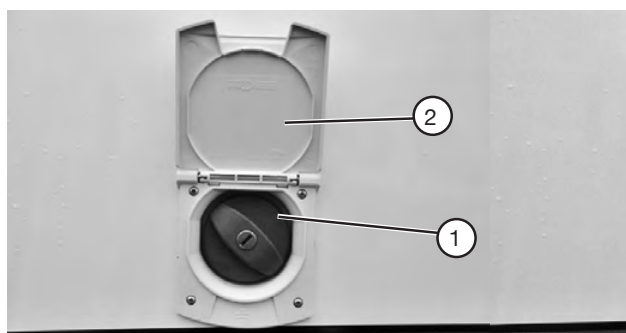

- Turn all taps to “warm”; let the water run and wait until the water runs without bubbles. This is the only way to ensure that the warm water boiler is also filled with water.



Always ensure that the fresh water tank is filled before switching on the pump. The pump can be destroyed if allowed to run dry!



Never introduce anti-freeze or other chemicals into the water system. This can be poisonous! When operating during winter ensure that the fresh water tank is sufficiently heated.

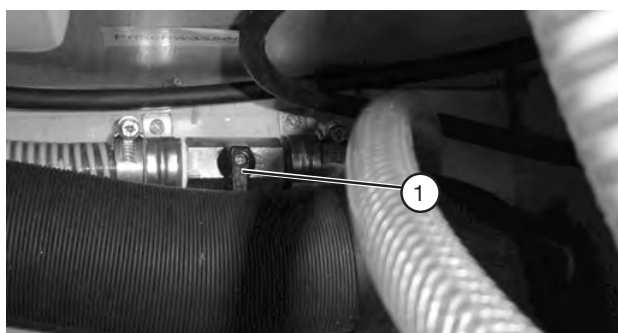

#### Emptying the fresh water tank

- The outlet valve ① is located either next to the fresh water tank in the seating arrangement on the outside wall or it can be accessed via a service flap.



Always empty the fresh water tank completely if the heating has not been switched on and the mobile home is not in use, and especially if there is frost.

**Hobby**



### Water filter

The standard vehicle is equipped with a drinking water filter to additionally reduce chlorine, fungi and algae in the tap water.

The waste water heating cartridge can only be switched on when the mobile home is connected to the 230V mains supply.

#### To hook up

- Fit the filter head into the appropriate opening and screw it in.

#### To remove

- Unscrew the filter until you can feel it loosen and then pull it out of the holder.

## Hobby

### Waste water tank

As an optional feature, the waste water tank can be outfitted with a heating cartridge (approx. 40 W) which prevents waste water from freezing in a light frost. Following activation of the waste water heating unit from the control panel it begins operation once the temperature of the waste water falls below approx. 8°C.



The waste water heating cartridge can only be switched on when the mobile home is connected to the 230V mains supply.



Do a small quantity of antifreeze agent (e.g. table salt) to the waste water tank if temperatures are significantly below freezing to prevent the waste water from freezing.



The waste water tank is not sufficiently protected against damage from frost when the vehicle is not in use. Therefore, if there is any danger of sub-zero temperatures empty the waste water tank completely.



Never pour boiling water down the sink. This can cause distortions and leaks in the waste water system.

### Draining the water system

Ensure that the motor home is in a horizontal position. Turn off the 12 V power supply at the control panel. Turn on all

drain cocks. If possible open the filler cap of the fresh water tank. Turn the water taps to the middle position and let them run.

Attach hand showers to the shower fitting. Check that water is draining out. Clean the tanks and rinse them thoroughly. Allow the water system to dry for as long as possible. Do not forget to empty the toilet cassette.



If the vehicle is not being used and there is a danger of sub-zero temperatures be sure to drain the entire water system. Leave taps turn on in the middle position. Leave all drain valves open.

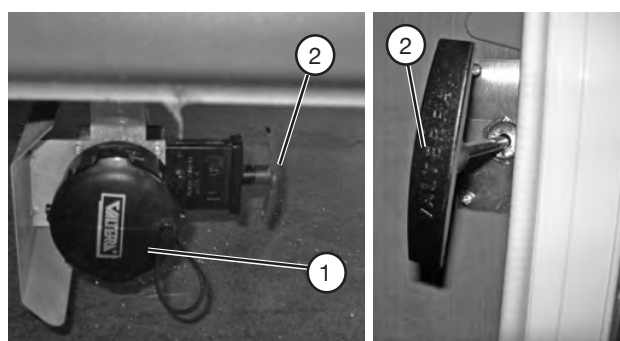

#### Emptying the waste water tank

- The waste water opening is located on the left side underneath the vehicle.
- The valve ② for opening the waste water opening is located either directly by the opening or in a protected position in the bottle container, depending on the model.
- Unscrew the lid ①, open the valve ② or the ball valve and allow the waste water to run off.
- When the waste water has drained out completely push the slide valve back in and screw the cap back on.



Only empty your waste water tank at the specially designated disposal points and never in open spaces! As a rule disposal points can be found at motorway service stations; campsites and petrol stations.

**Hobby**

### 8.3 Hot water supply

Your motor home is equipped with a heating system with integrated boiler. The boiler holds 10 litres of water. During summer use the water can be heated independently of the heating system. Please see Chapter 9.3 Heating for instructions on operating the boiler.



The non-electric safety or drain valve will automatically open at temperatures under approx. 3°C and drain the boiler contents via a drain nozzle.



If the cold water system is operated without the boiler the boiler tank will still fill with water. In order to avoid frost damage the boiler must be drained via the drain valve, even when not in use.

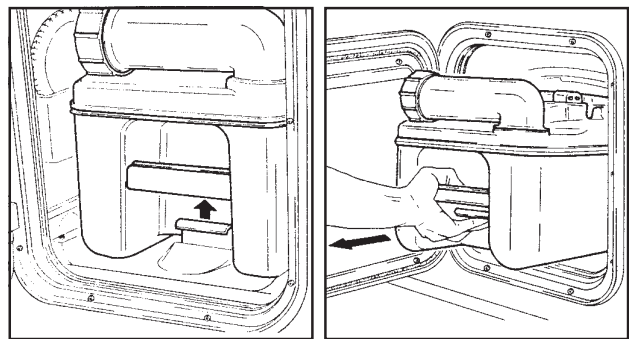

### 8.4 Flushing toilet

#### Preparing the toilet

- Open the Thetford door (see 5.1) and pull the holding bar up to remove the waste tank.



The waste tank can only be removed when the drain valve is closed.

- Pull out the tank as far as possible, keeping it level.
- Slightly tip the waste tank and then pull it out completely.
- Place it in an upright vertical position.
- Turn the drain nozzle to an upward position.

# Hobby

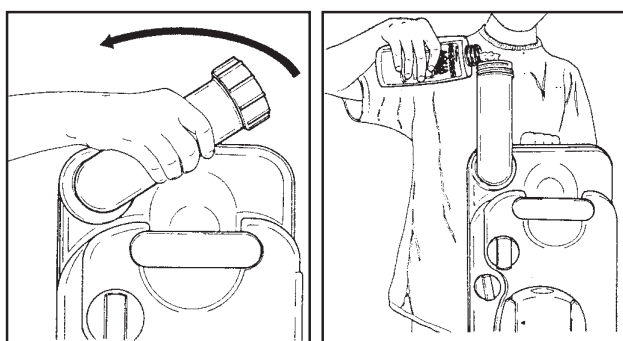

Use toilet fluids very sparingly. An overdose is no guarantee of preventing possible odours!

- Fill the waste tank with the correct amount of toilet fluids.
- Then add enough water to completely cover the bottom of the waste tank.
- Return the drain nozzle to its original position.

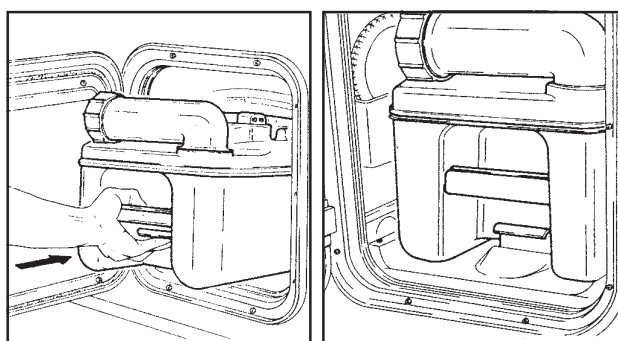

Never fill toilet fluids directly into the toilet bowl.

- Push the waste tank back into position.
- Ensure that the holding bar secures the waste tank.
- Close the service flap.

## Hobby



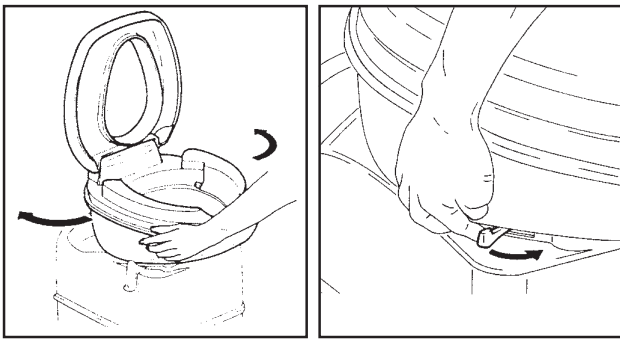

### Using the toilet

- Turn the toilet bowl to a comfortable position.
- Fill the toilet bowl with a small amount of water by pressing the flush button or by opening the drain valve by pulling the valve handle under the toilet bowl towards you.
- Use the toilet.
- After use open the drain valve (if still closed) and flush. Close the drain valve after flushing.

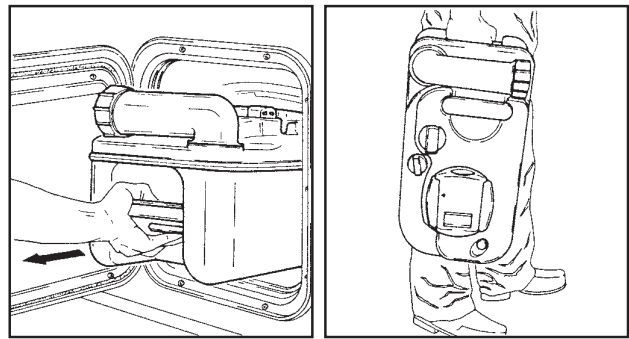

### Emptying the waste tank

The waste tank must be emptied at the latest when the LED lights up. It is recommended that the tank is emptied before this. The LED lights up when the tank contains more than 15 litres. From this point in time the tank has a residual capacity of 2 litres, representing approx. 5 flushes.

- Open the toilet flap and pull the holding bar up to remove the waste tank.



The waste tank can only be removed when the drain valve is closed.

# Hobby

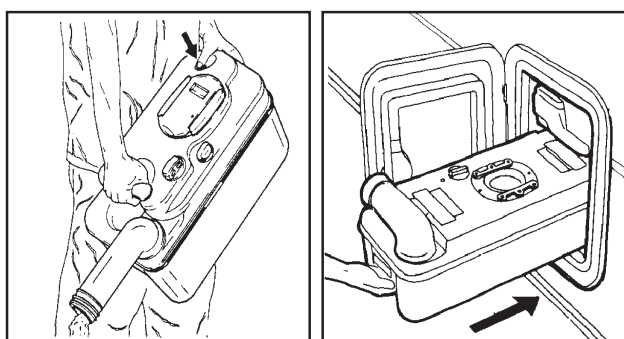

Only empty the waste tank at specially designated disposal points and never in open spaces!

- Take the waste tank to a designated disposal site, making sure to hold the drain nozzle in an upright position.
- Remove the cap on the drain nozzle.
- Tilt the waste tank so that the drain nozzle is pointing downwards.
- Press the vent button with your thumb and hold it down. The waste tank will drain itself.
- Return the waste tank to its storage position, ensuring that it is pushed in until the holding bar locks into place.
- Lock the service flap.



### Water connection for external shower (special request)

#### Opening

- Push the cover ① up to gain access to the water connection.

#### Closing

- Remove the external shower's hose from the connection point ② and attach the protective cover.
- Push the cover down.

**Hobby**

## Chapter 9: Gas

### 9.1 General safety rules when using LPG fittings

#### Checking the gas fittings

- Before initial operation have the LPG fittings checked by an expert.
- The gas fittings must be checked every 2 years by an LPG expert. This must be confirmed on the certificate (in accordance with Form G 607 from the German Association of Gas and Water Experts (DVGW) and EN 1949).
- The regulator and waste gas pipes must also be checked.
- We recommend that you replace the safety regulator at least every 6 years.
- The connecting hose should also be checked regularly for damage. Replace it immediately if you find tears, porous spots or similar damage.
- The operator is responsible for having checks carried out.



If you suspect that gas is leaking, take the following measures immediately:

- Close the stop valve on the gas cylinder.
- Ignition sources such as open flames or smoking are strictly forbidden.
- Air the rooms.
- Clear the danger zone.
- Inform your immediate surroundings (groundsman) and, if necessary, the fire brigade.

The gas fittings may only be taken into operation again after they have been checked by an expert.

#### Built-in objects and changes

- Objects may only be built in and changes to the gas fittings made by an expert.
- Only devices with a constant connection pressure of 30 mbar may be operated.
- Following any changes to the gas fittings they must be rechecked by a recognised expert, who must provide a written confirmation.

**Hobby**

### Regulators and valves

- Pressure governors must have a fixed pressure of 30 mbar. The regulations of EN 12864, Appendix D apply accordingly. The pressure governors must have a minimum flow rate of 1.2 hx/h.
- Attach the high-pressure hose on the bottle carefully by hand (note: left-handed thread). Do not use spanners, pliers or similar tools.
- If the temperature is below 5°C use the de-frosting facility (ice-ex) for regulators.



The operating pressure for gas is 30 mbar.

### Before initial operation

- The waste gas pipe must be tightly connected to the heating and chimney without any leaks. It may not be damaged.
- Keep vents clear.
- Remove any snow from the chimney.
- Clear aspirating openings for combustion air in the side all from dirt and/or snow. Otherwise, the exhaust fumes could have a CO content higher than allowed.
- Do not close the safety vents.
- Never use portable cookers or heating devices, except electric heating devices, however not radiant heaters, since they can cause fires or suffocation.



Read the manufacturer's operating manuals carefully!

# Hobby



## 9.2 Gas supply

The motor home is equipped with a propane gas system (gas bottle not included in scope of delivery). This system is used to run the following equipment:

- Cooker
- Refrigerator
- Heating
- Hot water boiler
- Oven
- Possibly special accessories

## Gas bottle cabinet

Depending on the model access to the gas bottle cabinet is either via the rear storage compartment or separately in the side wall.

The gas bottle cabinet holds 2 x 11 kg propane gas cylinders.

These are connected to the gas pressure governor mounted on the wall by means of high-pressure hoses with integrated protection against breakage. The governor is equipped with a gas flow monitor and an integrated test connection. Therefore, operation of the heating system while driving is explicitly permitted. The cylinders are secured using two independent straps.

# Hobby

**The following applies to the gas bottle cabinet:**

- Always check the gas cylinder mountings before driving. Stand the gas cylinders upright and close the valves (unless the heating is being used while driving).
- Pull any loose straps tight.
- The high-pressure hose to the cylinders must be checked for leaks using the leak detector every time a cylinder is changed.
- The gas bottle cabinet is not suitable for storing additional items.
- The stop valves on the gas cylinders must always be easily accessible.
- Do not close the gas bottle cabinet's air vents.
- Ensure that third parties cannot gain access to the gas bottle cabinet.
- Hold the hose breakage protector; unscrew the knurled nut (left-handed thread) and remove the breakage protection and the high-pressure hose from the gas cylinder.
- Loosen the fixing strap and remove the gas cylinder.
- Replace the full gas cylinder in the gas bottle cabinet and carefully fasten it using the fixing straps.
- Put the hose breakage protector and the high-pressure hose back on the cylinder and screw up the knurled nut (left-handed thread) tightly by hand.
- Open the main stop valve; press the green button on the hose breakage protector and the silver button on the SecuMotion (gas governor).
- Check that gas is not escaping from the connection point using leak detector spray.
- Close the gas bottle cabinet door.

**Changing gas cylinders**

Do not smoke or ignite open flames while changing the gas cylinders.

- Open the door of the gas bottle cabinet.
- Close the main stop valve on the gas cylinder. Pay attention to the direction of the arrow.

**Gas stop valves**

Every gas device is fitted with a corresponding gas stop valve. The gas stop valves are located in the kitchen drawer above the cutlery tray and are labelled with the corresponding symbols.

# Hobby



Heating (Oven) Gas cooker Refrigerator

**The following applies to stop valves and valves:**

- All the valves on gas devices must be closed while driving. The only exception is for the valves for heating devices being used while driving.



Over the years, vibrations can cause slight leakages to occur. If you suspect that there are leakages, have your dealer or an authorised workshop for gas facilities check your system.



Never carry out leak tests near an open flame.

**Hobby**

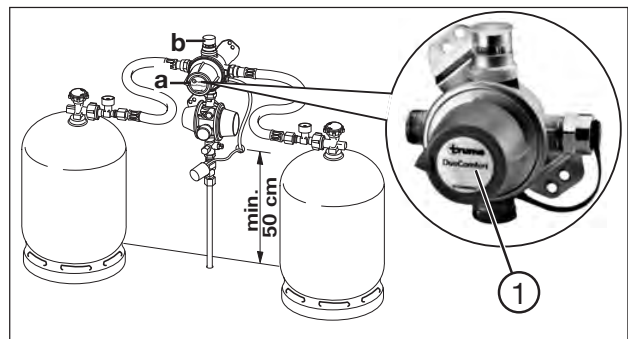

**Switching valve for the two-cylinder gas unit**

As an optional feature, your vehicle has a switching valve for the gas unit. Without interrupting the gas supply, the valve automatically switches the gas cylinders.

**a** Turn the knob to the left ① or right to determine which cylinder is to be used.

**b** Shows the status of the cylinder in use.

**Green: full**

**Red: empty**

**Function**

- Attach gas cylinders and open the valves of both gas cylinders. Turn the knob to the left or right as far as it will go.

If the pressure in the cylinder is less than 0.5 bar, the valve will automatically switch the cylinder.

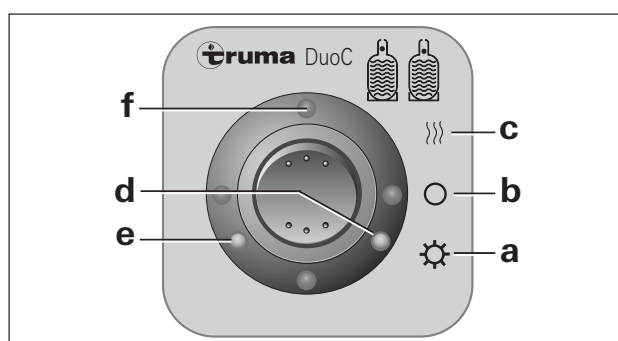

Do not change the cylinders near an open fire and never smoke when changing them!

**Remote indicator for the switching valve**

As an optional feature, your vehicle is equipped with a remote indicator for the switching valve for the two-cylinder gas unit.

- a** Operation in summer. Press the switch down and the LED will show the status of the cylinder in use.
- b** Display switched off.
- c** Operation in winter. Press the switch up and, in addition to showing the status, the switching valve will be heated (yellow LED lights up).
- d** Red LED (cylinder in use is empty)
- e** Green LED (cylinder in use is full)
- f** Yellow LED (operation in winter)

# Hobby



## Chapter 10: Built-in devices

### 10.1 General Information

In this chapter, you will find information on the devices that have been built into the mobile home. This information refers only to the operation of these devices. To some extent, the devices described are special accessories. For further information on the individual built-in devices, please refer to the separate operating instructions that have been included in the blue service bag found in the vehicle.



Built-in devices may only be repaired by specialists.



Only the device manufacturer's original spare parts may be used for maintenance and repair work.



Any changes to the built-in devices as well as non-compliance with the rules for use will cause the guarantee to become void and lead to the exclusion of liability claims. Furthermore, the operating licence for the device will become void and, in some countries, this means that the operating licence for the vehicle is also void.



Please also refer to the instructions in **Chapter 9** for operating gas devices, gas regulators and gas bottles.



Please observe the instructions in **Chapter 7** for operating electrical devices.

**Hobby**

## 10.2 Heating



The LPG heating system in your motor home has been designed to allow operation while driving. The requirements of EU Guideline 2001/56/EC for heating devices have been fulfilled so that LPG cannot escape involuntarily if there is an accident.

The combined LPG heating consists of a warm air heater with an integrated hot water boiler (capacity: 10 l).

The heating system is fully operational with or without the hot water system.

### Initial operation

- Set the air vents in the motor home so that the warm air is blown out where required.
- Check that the chimney is clear. Remove any covers.
- Open the gas cylinder and the gas stop valve.

### Operating panel

- a** Rotary switch for room temperature (1-5)
- b** green LED lights up: "ON"  
green LED flashes: "COAST DOWN" to reduce the heater's temperature.

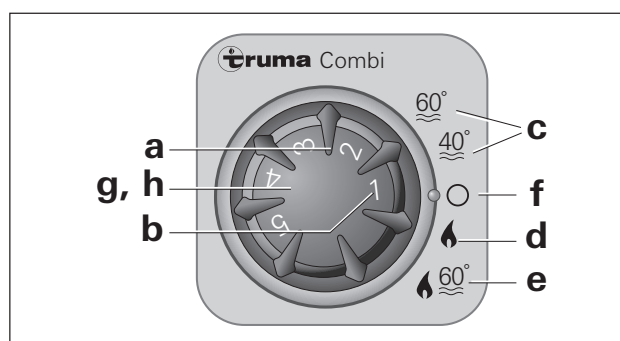

- c** Summer operation  
(Water temperature 40°C or 60°C)
- d** Winter operation  
(Heating **without** regulated water temperature or with drained water system)
- e** Winter operation  
(Heating with regulated water temperature)
- f** Rotary switch "OFF"
- g** Yellow LED lights up: "BOILER HEAT-UP PHASE"
- h** Red LED lights up, red LED flashes  
"MALFUNCTION": carefully clean the heater's rotary switch with a brush.

**Hobby**

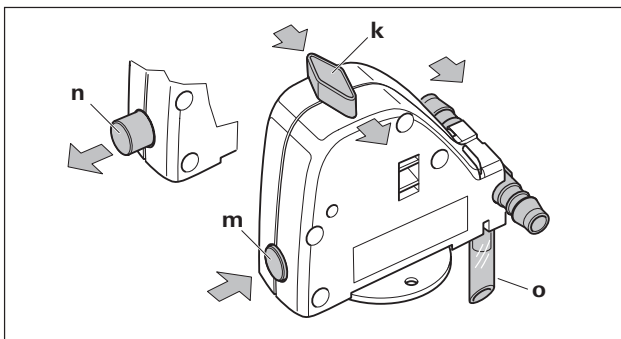

## FrostControl

FrostControl is a non-electric safety or drain valve. If there is a risk of sub-zero temperatures it automatically drains the content of the boiler via a drain outlet.

If the system is under excess pressure intermittent pressure equalisation will automatically take place via the safety valve. The outlet valve is located by the heating connection in your vehicle.

- k** Rotary switch position "ON"
- m** Push button position "CLOSED"
- n** Push button position "DRAIN"
- o** Drain outlet (to the outside through the vehicle floor)

## Hobby

### To activate

- Push in the knob at position **(m)** slightly and, at the same time, move it 90° towards position **(k)**.
- If the switch is in position **(k)**, the knob will remain in position **(m)**.

### To deactivate

- Turn the switch at position **(k)** by 90° so that it is parallel to the frost control.
- At the same time, the knob will jump from position **(m)** to position **(n)**.



The drain valve can only be closed manually using the push button (Position **m**) and the boiler filled if the valve temperature is above approx. 7°C.



If the temperature of the safety/drain valve is lower than approx. 3°C, the push button will be ejected (Position **n**) and the contents of the boiler will be drained off via the drain outlet **(o)**.

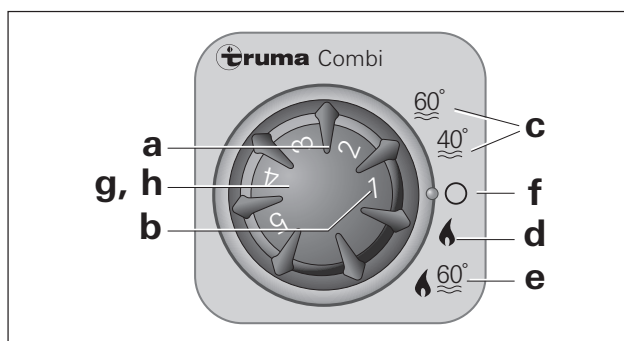

### Summer operation

- Turn the rotary switch on the operating panel to Position c (summer operation 40°C or 60°C).

The green (b) and yellow (g) LEDs will light up. When the water temperature selected (40°C or 60°C) has been reached, the burner will turn off and the yellow LED (g) will go out.

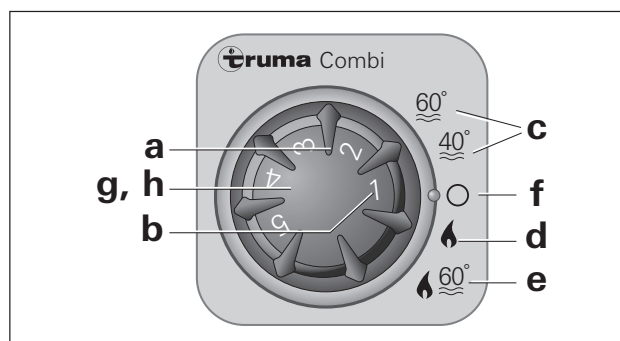

### Winter operation

#### Heating with regulated water temperature

- Set the rotary switch to operating position (e).
- Turn the rotary button (a) to the desired thermostat setting (1-5).

The green LED (b) for operation lights up and simultaneously displays the setting for the room temperature selected.

The yellow LED (g) indicates the warming up phase for the water. The device will automatically select the performance level required. When the room temperature set on the operating panel has been reached the burner will

**Hobby**

revert back to the lowest setting and heat the water in the boiler to 60° C. The yellow LED (**g**) will go out when the water temperature has been reached.

#### Heating without regulated water temperature

- Set the rotary switch to operating position (**d**).
- Turn the rotary button (**a**) to the desired thermostat setting (1-5).

The green LED (**b**) for operation lights up and simultaneously displays the setting for the room temperature selected. The yellow LED (**g** – warming-up phase for the water) only lights up at water temperatures below 5°C. The device will automatically select the performance level required.

When the room temperature set on the operating panel has been reached the burner will turn off. The warm air blower will continue to run at a low rotation speed as long as the air emission temperature (of the device) is above 40°C. If the boiler is full the water will automatically also be heated. The water temperature will depend on the heat produced and the duration of heating required to reach the room temperature selected.

#### Heating with drained water system

- Set the rotary switch to operating position (**d**).
- Turn the rotary button (**a**) to the desired thermostat setting (1-5).

The green LED (**b**) for operation lights up and simultaneously displays the setting for the room temperature selected. The yellow LED (**g**) only lights up if the temperature of the device is below 5°C. The device will automatically select the performance level required.

When the room temperature set on the operating panel has been reached the burner will turn off.

# Hobby

**Turning off**

- Turn the heater off using the rotary switch (position **f**). The green LED (**b**) will go out.



If the green LED (**b**) flashes after the device has been turned off, a coast-down phase to reduce the device's temperature is being carried out. This will finish after a few minutes and the green LED (**b**) will go out.



In the case of malfunction, the red LED (**h**) will light up. Please check the manufacturer's instructions to determine possible causes of malfunction.

**Filling up the boiler**

- Close the drain valve by pushing the button until it locks into place.
- Turn on the 12V power supply by turning on the main switch on the control panel.
- Turn on all taps and set them to "warm". Leave them on until the boiler fills up due to the air displacement.



At temperatures below approx. 7°C turn on the heating first in order to warm up the installation area and the FrostControl on the drain valve. After a few minutes, when the temperature on the FrostControl is above 7°C, the drain valve can be closed.

**Draining the boiler**

- Turn off the 12V power supply at the control panel.
- Turn on the hot water taps.
- Turn the rotary switch on the drain valve 180° until it locks into place (the push button will be ejected), the drain valve will open and the boiler contents will drain off to outside.

# Hobby

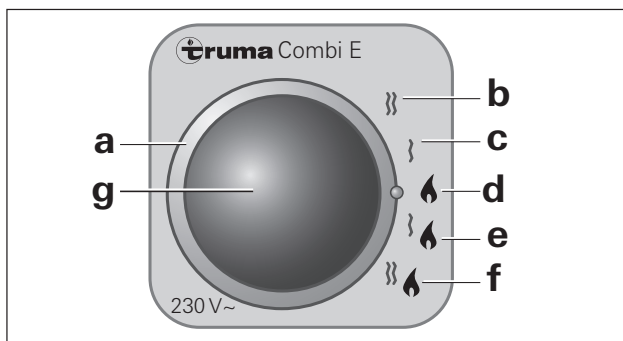

- a Rotary switch for selecting type of energy
- b Electrical operation: 230 V, 1800 W
- c Electrical operation: 230 V, 900 W
- d Operating on gas
- e Mixed operation\* (gas and electrical operation, 900 W)
- f Mixed operation\* (gas and electrical operation, 1800 W)
- g Yellow LED lit up: "Electrical operation"

\*For operation in winter only!

When operating in summer, the device automatically selects electrical operation with the preselected electric power (900 W or 1800 W).

### 10.3 Electric Heating System (Special Accessory)

The electric heating system also has heating rods to enable electric operation. These can be switched on or combined manually.

# Hobby



#### 10.4 Auxiliary Heating in the Driver's Cab (Special Accessory))

As a special accessory, your vehicle can be equipped with auxiliary heating for the driver's cab and the motor. This heating unit is integrated in the water circuit; electric power is supplied by means of the 12V modular battery.

##### Function

The heating function is set manually using the switch in the driver's cab.

Set the switch to position ① to heat the driver's cab.

Set the switch to position ② if you prefer to heat the motor; this will, however, also preheat the interior.

**Hobby**



## 10.5 Refrigerator

### Modes of operation

Three modes of operation are possible for the refrigerator.

- 12 V operation: electricity is supplied by the motor home's battery.
- 230 V operation: electricity is supplied from an external source.
- LPG: supply is from the motor home's gas bottles



Please refer to the manufacturer's separate operating instructions before using the refrigerator.

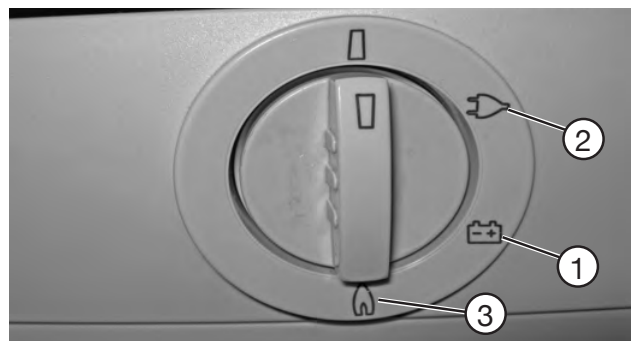

### 12 V operation

12 V operation can only be used while driving, when the motor is running. When resting or if you have stopped for a longer period of time, turn off the 12 V operation and, if required, select another mode of operation.

- Turn the energy selector switch to battery operation ①.
- 12V operation will only function if the vehicle's motor is running.
- The refrigerator runs without a thermostatic control (continuous operation). 12 V operation should, therefore, only serve to maintain a temperature which has already been achieved.

**Hobby**

- To turn the refrigerator off turn the energy selector switch to the O position.

### 230 V operation

- Turn the energy selector switch to mains ②.
- Set the temperature using the thermostat.
- To turn the refrigerator off turn the energy selector switch to the O position.

### Gas operation

- Turn the energy selector switch to gas operation ③.
- Open the main stop valve on the gas cylinder and the “Refrigerator” gas stop valve.
- Turn the thermostat to the highest setting and keep it pressed down. The refrigerator will either automatically ignite or by pressing the button for manual ignition (depending on the model).
- When the pilot light has ignited, let go of the thermostat. Repeat the previous step if there has not been ignition.
- Set the cooling temperature using the thermostat.
- To turn the refrigerator off turn the energy selector switch to the O position
- Close the main stop valve on the gas cylinder and the “Refrigerator” gas stop valve.

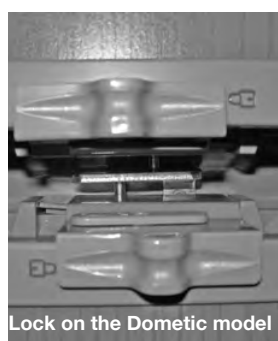

Lock on the Dometic model 1



Lock on the Dometic model 2

### Refrigerator door lock



While driving, the refrigerator door must always be closed and locked.

The refrigerator door has an automatic lock. If the door is closed and pushed firmly it will lock automatically.

#### Lock on Dometic 1:

Push the lock to the left to open the refrigerator and to the right to close it.

#### Lock on Dometic 2:

Press the push button and pull open the refrigerator door.

**Hobby**

## 10-11 | Built-in devices



To avoid mould or unpleasant odours always lock the refrigerator door in the ventilation position when the refrigerator is turned off.



### Freezer compartment

If the outside temperature and the rate of humidity are very high, drops of water may form on the metal frame of the separate freezer compartment. For this reason, it has been fitted with a frame heater (Dometic only). If the outside temperature and the rate of humidity are very high, switch the frame heater on by pressing ①. This helps to avoid corrosion. When the frame heater is on, the control light ② will shine.

# Hobby



## 10.6 Gas cooker

The kitchen in the motor home is equipped with a gas cooker with three burners.

### Before initial operation

- Open the bottle valve and the quick-action stop valve in the gas pipe.
- Open the skylight or the kitchen window
- Ignition points which must be pressed for ignition when turning on the gas device should spring back to their original position after being pressed.



Never use the cooker or other devices extracting combustion air from the interior of the vehicle to heat the vehicle. If this is ignored there is an acute risk to life due to a lack of oxygen and the odourless carbon monoxide which could be generated.



Do not operate the cooker when the glass covering is closed.

**Hobby**



### Operation

- Open the tinted glass covering ①.
- Turn the rotary switch ② of the burner you wish to use to the ignition position (large flame) and press.
- Ignite the burner with a gas lighter or a match or cigarette lighter.
- Continue to press the rotary switch for a further 5-10 seconds to ensure that the automatic flame guard takes effect.
- Release the rotary switch ② and turn to the desired setting (large or small flame).
- If ignition was unsuccessful, repeat the procedure.

- To turn off the gas flame, turn the rotary switch back to the “0” position
- Close the main gas stop valve on the gas cooker.



Use oven gloves or potholders when handling hot pots, pans or similar objects. You may be burned!



After cooking, leave the glass covering open until the burner no longer emits heat. Otherwise, the glass plate could explode.



Never store easily flammable objects such as dishtowels, serviettes, etc. near the cooker. Danger of fire!

## Hobby



### 10.7 Oven (Special Accessory)



- Do not close the air vents on the oven.
- Only use the oven after making a 230 V or 12 V mains connection (automatic ignition).
- A skylight or window must be open when the oven is in operation.
- The oven door must remain open during the ignition process.
- If there is no ignition repeat the procedure from the beginning.
- In the event the pilot light is extinguished by mistake set the rotary switch to the "0" position and leave the pilot light out for at least one minute before reigniting it.



- Never operate the oven when it is empty (no food inside).
- Never use the grill (special accessory) for longer than 25 minutes.
- Never use the oven to heat the motor home.

#### Switching on

- Turn on the 12 V power supply at the main switch of the control panel.
- Open the main stop valve on the gas cylinder and the gas stop valve "Oven".
- Open the oven door as far as it will go.
- Position the oven rack or baking tray in such a way that there is no direct contact with the flame.
- Gently press the rotary switch and set it to the desired ignition position (oven or grill).
- Press the rotary switch. Gas will be released to the burner and the flame will ignite automatically.
- Depress the rotary switch for a few seconds until the ignition safety valve keeps the gas supply open.
- Release the rotary switch and set it to the desired level of performance (oven only).
- Close the oven door carefully so that the flame is not extinguished.

**Hobby**

## 10-15 | Built-in devices

### Switching off

- Turn the rotary switch to the “0” position. The flame will be extinguished.
- Close the main stop valve on the gas cylinder and the gas stop valve “Oven”.

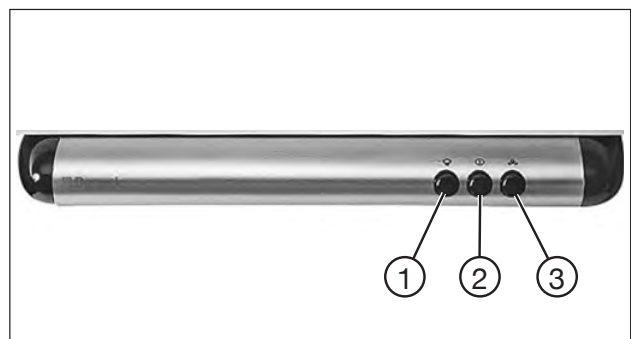

### 10.8 Fume Hood (Special Accessory)

As an option, the kitchen can be fitted with a fume hood. The built-in fan blows kitchen odours directly outside.

- ① Light
- ② To switch on
- ③ To set the speed for the fan



Clean the filter of the fume hood regularly, as it collects fat from kitchen odours.

# Hobby



### 10.9 Rooftop Air Conditioning (Special Accessory)

As an optional feature, your vehicle is equipped with an air conditioner in the living room instead of a skylight.

To operate the air conditioner correctly and optimize its performance, you should observe the following:



- Ensure sound thermal insulation; seal chinks and cover up glass areas.
- Avoid opening doors and windows unnecessarily.
- Do not plug or cover up air intakes and openings.
- Do not spray water into the air conditioner.
- Keep all easily inflammable material away from the system.

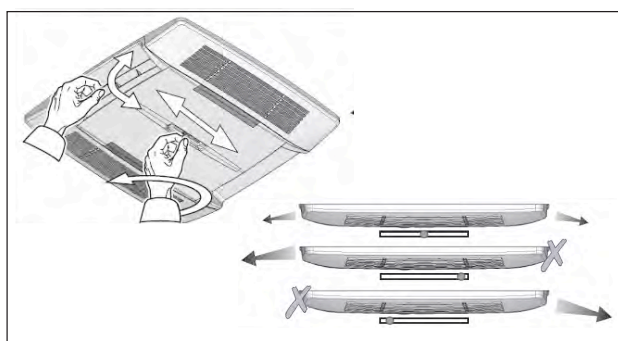

#### To set the direction of ventilation

- First turn the knob counter-clockwise.
- Set the slide to correspond with the desired direction of ventilation.
- Turn the knob clockwise.

**Hobby**



## Chapter 11: Maintenance and Care

### 11.1 Maintenance

#### Maintenance intervals

There are stipulated maintenance intervals for the motor home and its equipment.



Also note the maintenance intervals for the basic Ford vehicle.

#### The following applies for maintenance intervals:

- Have the first maintenance carried out by a HOBBY dealer 12 months after the vehicle was first registered.
- All further maintenance should be carried out once a year by a HOBBY dealer.
- The maintenance of the basic vehicle as well as all built-in equipment should be carried out at the intervals given in each operating manual.



The gas fittings must be checked every 2 years by an expert for LPG and confirmed on the certificate in accordance with DVGW G 607 and EN 1949.

# Hobby



The operator of the vehicle is responsible for having maintenance carried out on schedule.



Replace the safety regulator for gas at least every 6 years!



For safety reasons, spare parts for equipment must conform with the manufacturer's instructions and must be installed by him or a duly authorised representative.

### 11.2 Airing

For a comfortable climate inside the caravan, there must be sufficient ventilation. This also avoids corrosive damage due to condensation.

#### Condensation is caused by

- insufficient volume inside the caravan
- breathing and perspiration of the passengers
- bringing in damp clothing
- operating a gas cooker



Ensure that there is a sufficient exchange of air to avoid damages due to the build-up of condensation!

### 11.3 Care

#### Cleaning the exterior

The vehicle should not be washed more often than necessary.



Wash the vehicle only in places provided for this purpose.



Using cleaning materials sparingly. Aggressive cleansers, such as wheel rim cleaners, damage the environment.



Only wash the vehicle at sites designated for this purpose. Avoid direct exposure to sunlight and adhere to environmental protection measures. Do not use cleaning agents containing solvents.

#### The following applies when cleaning the exterior:

- Rinse the vehicle with a weak jet of water.
- Wash the vehicle with a soft sponge and a commercial shampoo solution. Rinse the sponge often.
- Then rinse with a generous amount of water.
- Dry the vehicle with a suede cloth.
- After washing the vehicle, leave it standing outside to dry off completely.



Dry the headlights and sockets thoroughly, as water collects there easily.

#### Washing with a high pressure cleaner



Do not spray stickers and external decors directly with the high pressure cleaner as they could peel away as a result.

Before washing the motor home with a high pressure cleaner, study its operating manual carefully. During washing maintain a minimum distance of 700 mm between the motor home and the high pressure cleaner. Please note that the water jet is under pressure when it comes out of the cleaning nozzle. Incorrect handling of the high pressure cleaner can result in damage to the motor home. The water temperature should not exceed 60°C. Keep the water jet moving while washing. The jet should not be pointed directly at gaps around doors; gaps around windows; acrylic windows; electric attachments; the exhaust chimney; refrigerator grille; connectors; seals; service flaps or skylights as this could damage the vehicle or result in water penetrating inside the vehicle.

**Hobby**

**The following applies when waxing the surfaces:**

- The varnished surfaces should be treated occasionally with wax. Follow the application instructions given by the wax manufacturers.

**The following applies when polishing the surfaces:**

- In exceptional cases, use polish to refinish weathered varnished surfaces. We recommend solvent-free polishing paste.



Use polish only in special cases and as seldom as possible, because polish removes the top layer of varnish. Frequent polishing causes extreme wear.

**The following applies for tar and resin stains:**

- Tar and resin stains as well as other organic stains can be removed with petroleum ether or spirits.



Do not use aggressive solutions such as products containing ester or ketone.

**The following applies for damages:**

- Repair damages immediately to avoid further damages due to corrosion. Ask your HOBBY dealer for assistance.

**Skylights, windows and doors**

Window panes require particularly careful treatment.

**The following applies for their care:**

- Rub the rubber seals around doors and windows lightly with talcum powder.
- Clean acrylic glass panes only with a clean, wet sponge and a soft cloth. Cleaning with a dry cloth may scratch the panes.



Do not use strong and aggressive solutions that contain softeners or solvents!



You will find talcum powder in auto accessory shops.

**Cleaning the interior**

**The following applies for cushions, upholstery and curtains:**

- Clean cushions with a soft brush or Hoover.

**Hobby**

- Have very dirty upholstery and curtains dry-cleaned. Do not wash them yourself!
- If necessary, wash them carefully using the foam from mild-action detergent.

**The following applies for carpeted floors:**

- Clean with a Hoover or brush.
- If necessary, treat with carpet shampoo or a shampooing machine.

**The following applies for the PVC flooring:**



Sand and dust can damage the surface of PVC flooring that is walked on regularly. When in use, clean the floor daily with a Hoover or a broom.

- Use cleansing agents for PVC floors and clean water when washing the floor. Do not place fitted carpets on a wet PVC floor, as the fitted carpet and the PVC flooring could become glued together.
- Never use chemical cleansing agents or steel wool, because this will damage the PVC flooring.

**The following applies for furniture surfaces:**

- Clean the surface of wooden furniture with a damp cloth or sponge.
- Rub dry with a dust-free cloth.
- Use mild furniture polish.



Never use strong cleansers or intensive furniture polish, because this could scratch the surface!

**The following applies for the toilet:**

- Clean with a neutral liquid cleanser and a cloth that does not scratch.



Never use strong cleansers in the toilet!



Do not use diluted acetic acid to clean the toilet and the water system or for descaling the water system. Diluted acetic acid can damage the seals or parts of the system.



Do not pour any corrosive substances down the drains. Do not pour boiling water down the drains. Corrosive substances and boiling water damage drain pipes and syphons.

**The following applies for the sink and the cooker:**

- Clean stainless steel parts with normal household cleaners or special stainless steel cleansing agents.

**Hobby**

## Accessories

### The following applies for their care:

- Clean plastic parts (e.g. fenders, skirts) with water of up to 60° C and mild household cleansers.
- Clean greasy or oily surfaces with spirits.
- If necessary, lubricate door hinges and leveling supports.
- Clean fresh water pipes, the fresh water and waste water tanks once a year.



Do not use strong cleansers, because these could scratch the surface!



Remove all spray cans containing cleansing and care solutions from the vehicle after you have finished! Otherwise they may explode if the temperature exceeds 50° C!

## 11.4 Winter Lay Up for the Mobile Home

The camping season often ends when winter starts. Your mobile home must be prepared accordingly before being laid up for the winter.

It should only be left in a closed space if this is dry and easy to air well. Otherwise, it is better to leave your mobile home in the open.

### The following applies for the base vehicle and the external superstructure:

- Preserve varnished external surfaces with suitable agents.
- Use a wax-based protective agent to protect the metal parts of the undercarriage against rust.
- To protect the tires, jack up the mobile home and move it every two months.
- Leave space between tarpaulins and the mobile home so as not to hamper ventilation.
- Leave the forced ventilation open.
- Air the mobile home thoroughly every three to four weeks.
- Check the antifreezer in the cooling system and, if necessary, top it up.

**Hobby**

**The following applies for tanks and containers:**

- Empty and clean the fresh water tank.
- Empty and clean the waste water tank.
- Empty and clean the toilet tank.
- Completely empty the hot-water boiler: use the control panel to switch off the electric power supply and open all of the water taps.
- Shut the main stop valve on the gas cylinder as well as all separate gas stop valves. Always take the gas cylinders out of the gas bottle container, even if they are empty.



Also note the information and operating instructions given by the manufacturers of the built-in equipment.

**The following applies for the interior fittings:**

- Empty and clean the refrigerator; leave the refrigerator door open.
- Leave stowage spaces and cupboards open to enable air circulation.
- Place cushions and mattresses in such a way that they do not come into contact with condensation.
- If necessary, heat the mobile home to prevent the build-up

of mould from condensation.

- Set up a dehumidifier (such as salt) inside the camper and dry the granulate or change it regularly.
- Open the battery's circuit breaker. Ideally, remove the battery and/or check the charge level approx. once a month; if necessary, recharge it.
- Switch off the main switch for 12V.

# Hobby

## 11.5 Winter Operation

### Preparations

Your mobile home has been designed to allow you to use it to a certain extent in winter. If you really wish to camp in winter, we recommend that you optimize your mobile home to meet your personal requirements. Your dealer will be pleased to advise you.

#### The following applies for your preparations:

- Check the vehicle for damage to the paintwork or from rust and, if necessary, repair it.
- Ensure that water cannot run into the ventilation and de-aerating and heating systems.
- Use a wax-based protective agent to protect the metal parts of the undercarriage against rust.
- Preserve varnished external surfaces with suitable agents.
- Fill the petrol tank with winter diesel; check the antifreezer in the windshield cleaning unit and the coolant.

During operation in winter, condensation is caused when using the camper in low temperatures. Sufficient ventilation is extremely important to ensure that the quality of the air inside the camper is good and to avoid damages to the vehicle caused by condensation.

# Hobby

#### The following applies for ventilation:

- Set the heating to maximum power when heating up the vehicle and open all of the upper cupboards, curtains and shades/screens. This enables you to achieve optimum ventilation and de-aerating.
- Every morning, air all of the cushions and stowage spaces and dry any damp spots.
- Air thoroughly with fully opened doors and windows several times a day.
- If the outside temperature is under 8° C, winter covers should be mounted over the ventilation grilles of the refrigerator.



If, despite all of these measures, condensation forms, simply wipe it away.



Before entering the vehicle, remove the snow from your clothes and shoes to prevent an increase in humidity.

#### The following applies for heating:

- Both the air intake as well as the exhaust gas openings of the heating system must be kept free of snow and ice.
- It takes longer to heat up the mobile home in winter, especially to heat hot water.

- Do not let the interior cool down completely when you are away or at night; set the heating to low and leave it on.



If there is danger of frost, or if you are in the vehicle, you must let the heating run during the night!



Check the gas supply when operating the vehicle in winter: up to three times as much gas is used.

#### The following applies for tanks and containers:

- If the interior is sufficiently heated, the fresh water tank, water pipes and therme/boiler should not freeze. Fill all of the water containers only after the interior has been thoroughly heated.
- Since waste water is collected outside the vehicle, add antifreezer or common salt to it. The drain cock of the sewage pipe must be kept clear.
- The toilet can be used normally, even in cold weather, as long as the interior of the mobile home is heated. If there is a danger of frost, both the excrement and the flushing water tanks should be emptied.

### At the end of the winter season

#### The following applies for the care of the vehicle:

- Thoroughly wash the underbody and the motor. This removes corrosive thawing agents (salts, alkali).
- Clean the exterior and use normal car wax to preserve metal parts.
- Do not forget to remove flue extensions, cover panels on refrigerators, etc.



Wash the vehicle only in places provided for this purpose.



Using cleaning materials sparingly. Aggressive cleansers, such as wheel rim cleaners, damage the environment.

# Hobby



## Chapter 12: Sanitation and Environmental Protection

### 12.1 The environment and traveling

#### Environmentally fair use

It is only natural that owners of motor homes and caravans have a special responsibility for the environment. Always use your vehicle in an environmentally friendly way.

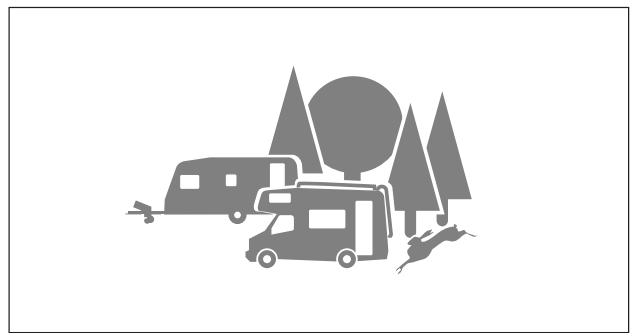

#### The following applies for environmentally fair use:

- When spending longer periods in towns and cities ask about specially designated campsites for motor homes and use them.
- Do not spoil the peace and cleanliness of nature.
- Dispose of waste water and rubbish in the proper way.
- Set an example so that motor home and caravan drivers are not generally held to be pollutionists.

**Hobby**



**The following applies for waste water:**

- Collect waste water on board only in built-in waste water tanks or, if necessary, in suitable containers!
- Never empty waste water in open spaces or down man-holes! Generally, the public waste water system does not run through clarification plants.
- Empty your waste water tank as often as possible, even if it is not completely full (hygiene). If possible, rinse out the waste water tank with fresh water after emptying.



Only empty your waste water tank in special places for waste water disposal, but never in open spaces! Generally, waste water stations are found in motorway service areas, campsites or petrol stations.

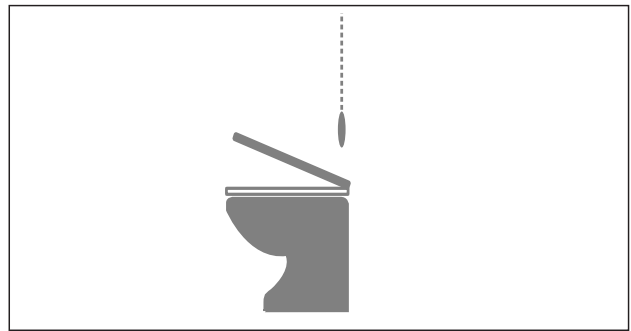

**The following applies for wastes:**

- Only use approved sanitary cleansing products in the waste tank.



You may be able to avoid the use of sanitary liquids by installing an activated carbon filter system (sold as an accessory)!



Use sanitary liquids very sparingly. An overdose is no guarantee of preventing odours!

**Hobby**

### Sanitation

- Never allow the waste tank to become too full. Empty the tank immediately as soon as the level indicator lights up.
- Never empty wastes down manholes! Generally, the public waste water system does not run through clarification plants.



Empty the waste tank in special places for sanitary disposal, but never in open spaces!



#### The following applies for waste:

- Separate your waste and put appropriate materials in the recycling bins.
- Empty waste bins as often as possible in the appropriate bins or containers. This avoids unpleasant and problematic waste from building up on board.

#### The following applies for picnic spots:

- Always leave picnic spots clean and tidy, even if you dispose of someone else's waste.



Careful use of the environment is not only in the interest of nature, but also of motor home and caravan drivers everywhere!

# Hobby

## 12.2 Returning the vehicle

If you should ever have to give up your motor home and have it recycled, the manufacturer of the basic vehicle is responsible for taking it back (status at the time of printing).

This means that your HOBBY motor home will be taken back free of charge by any Ford dealer and expertly recycled.

**Hobby**

## Chapter 13: Technical Data

### 13.1 Weights according to 92/21/EWG

Model	Series	Weight of basic vehicle	Driver	Diesel [kg]	Basic equipment	Mass when vehicle is ready to start	Techn. perm. overall weight	Overload weight	No. of seats	Conventional loading	Overload weight	Length of vehicle	Personal equipment	Remaining overload weight
T 500 GFSC	Van (A)	2420	75	68	110	2673	3500	827	4	225	602	6,0	100	502
T 500 FSC	Van (A)	2444	75	68	110	2697	3500	803	4	225	578	6,0	100	478
T 500 FSC LE	Van (A)	2505	75	68	110	2758	3500	742	4	225	517	6,0	100	417
TL 500 GESC	Van Exclusive (K)	2600	75	68	110	2853	3500	647	4	225	422	6,8	108	315
T 600 FC	Siesta Exclusive (X)	2603	75	68	110	2856	3500	644	3	150	494	6,5	95	399
T 650 FLC	Siesta Exclusive (X)	2744	75	68	110	2997	3500	503	4	225	278	7,0	110	169
T 555 AK GFSC	Siesta (C)	2610	75	68	110	2863	3500	637	4	225	412	5,8	98	314
T 555 AK GFSC LE	Siesta (C)	2690	75	68	110	2943	3500	557	4	225	332	5,8	98	234
T 600 AK KM	Siesta (C)	2728	75	68	110	2981	3500	519	4	225	294	6,4	104	190
T 650 AK GFM	Siesta (C)	2815	75	68	110	3068	3500	432	4	225	207	6,9	109	98
T 650 AK GFM **	Siesta (C)	2815	75	68	29	2987	3500	513	6	375	138	6,9	129	9
T 650 ESC LE	Siesta Exclusive (V)	2990	75	68	110	3243	3850	607	4	225	382	7,0	110	272
T 650 ESC LE *	Siesta Exclusive (V)	2990	75	68	29	3162	3500	338	4	225	113	7,0	110	3

These figures refer to the standard vehicle without extra equipment. Deviations of up to 5 % are possible.

\* Reduction of load capacity to 3,500 kg.

\*\* Optional additional belt rack

# Hobby

### 13.2 Inflation pressures

Tyres	Tyre pressure (bar)	Basis
Michelin XC Camping		
215/75 R 16 C	front: 3,5 rear: 5,5	FORD
other tyre manufacturers*		
185/75 R 16 C	front: 4,7 rear: 3,5	FORD
215/75 R 16 C	front: 3,5 rear: 4,75	FORD

\*These tyre inflation pressures are only valid for standard tyres by alternative manufacturers (e.g. Continental, Goodyear, etc.)

**Hobby**

## 13.3 Technical data

Hobby Model	Model	Type	Base vehicle	Motorisation <sup>5)</sup> Model	Chassis	Frame extension	Tow-bar	
							Towing bracket	Spherical head
<b>FORD Transit V347 (front wheel drive)</b>								
<b>T 500 GFSC</b>	Van	H2	FORD Transit FT 350 M	2.2 TDCi (85 kW)	Flat bottom	205914 lowered	SAWIKO 30LF70003P	Typ 05 (3009000500)
<b>T 500 FSC</b>	Van	H2	FORD Transit FT 350 M	2.2 TDCi (85 kW)	Flat bottom	205914 lowered	SAWIKO 30LF70003P	Typ 05 (3009000500)
<b>T 500 FSC LE</b>	Van	H2	FORD Transit FT 350 M	2.2 TDCi (103 kW)	Flat bottom	205914 lowered	SAWIKO 30LF70003P	Typ 05 (3009000500)
<b>TL 500 GESC</b>	Van Exclusive	H2	FORD Transit FT 350 L	2.2 TDCi (85 kW)	Flat bottom	205913 lowered	SAWIKO 30LF70001P	Typ 05 (3009000500)
<b>T 600 FC</b>	Siesta Exclusive	H2	FORD Transit FT 350 L	2.2 TDCi (85 kW)	Flat bottom	205821 level	SAWIKO 30LF70008P	Typ 04 (3009000400)
<b>T 650 FLC</b>	Siesta Exclusive	H2	FORD Transit FT 350 L	2.2 TDCi (85 kW)	Flat bottom	205823 level	SAWIKO 30LF70002P	Typ 04 (3009000400)
<b>T 555 AK GFSC</b>	Siesta	H2	FORD Transit FT 350 M	2.2 TDCi (85 kW)	Flat bottom	206381 level	SAWIKO 30LF70010P	Typ 04 (3009000400)
<b>T 555 AK GFSC LE</b>	Siesta	H2	FORD Transit FT 350 M	2.2 TDCi (103 kW)	Flat bottom	206381 level	SAWIKO 30LF70010P	Typ 04 (3009000400)
<b>T 600 AK KM</b>	Siesta	H2	FORD Transit FT 350 L	2.2 TDCi (85 kW)	Flat bottom	205822 level	SAWIKO 30LF70007P	Typ 04 (3009000400)
<b>T 650 AK GFM</b>	Siesta	H2	FORD Transit FT 350 L	2.2 TDCi (85 kW)	Flat bottom	205824 level	SAWIKO 30LF70009P	Typ 04 (3009000400)
<b>FORD Transit V348 (rear wheel drive)</b>								
<b>T 650 ESC LE</b>	Siesta Exclusive	H3	FT 350 L	2.4 TDCi (103 kW)	Ladder-type chassis frame	204310 level	BOSAL 3959-A	---

All measurements in [mm]                      all weights in [kg]

- 1) incl. roof rail if it is standard equipment
- 2) without wing mirror, without side blinker
- 3) tow coupling is a special accessory. Please observe the maximum towing weight.
- 4) rear edge of traction unit to rear edge of back wall
- 5) 2,2 TDCi 85 kW (115 PS); 2,2 TDCi 103 kW (140 PS); 2,4 TDCi 103 kW (140 PS)
- 6) 2-point (lap) belt rack facing towards the rear (special accessory): UTP 620 (20-10006950)

# Hobby

Belt system	Seats	t.z.G. [kg]	Permissible front axle load	Permiss. rear axle load	Unbraked trailer load <sup>3)</sup>	Braked trailer load <sup>3)</sup>	Maximum towing weight	Length of super-structure <sup>4)</sup>	Total length <sup>1)</sup>	Height <sup>1)</sup>	Width <sup>2)</sup>	Front tread width	Rear tread width	Wheel base	Front projection	Rear projection <sup>1)</sup>
<b>FORD Transit V347 (front wheel drive)</b>																
UAP 324 (20-10006953)	4	3500	1750	2250	750	1000	4500	3701	5999	2710	2140	1757	1718	3300	933	1766
UAP 324 (20-10006953)	4	3500	1750	2250	750	1000	4500	3701	5999	2710	2140	1757	1718	3300	933	1766
UAP 324 (20-10006953)	4	3500	1750	2250	750	1000	4500	3701	5999	2710	2140	1757	1718	3300	933	1766
UAP 324 (20-10006953)	4	3500	1750	2250	750	1000	4500	4397	6750	2710	2180	1757	1718	3750	933	2067
MSP 500 (20-10005970)	3	3500	1750	2250	750	1000	4500	4083	6452	2830	2360	1757	1718	3750	933	1769
UAP 141 (20-10006948)	4	3500	1750	2250	750	1000	4500	4586	6955	2830	2360	1757	1718	3750	933	2272
UAP 325 (20-10007513)	4	3500	1750	2250	750	1000	4500	3699	5999	2940	2286	1757	1718	3300	933	1766
UAP 325 (20-10007513)	4	3500	1750	2250	750	1000	4500	3699	5999	2940	2286	1757	1718	3300	933	1766
UAP 380 (20-10006949) <sup>6)</sup>	4	3500	1750	2250	750	1000	4500	4031	6407	2940	2286	1757	1718	3750	933	1724
UAP 380 (20-10006949) <sup>6)</sup>	4	3500	1750	2250	750	1000	4500	4547	6923	2940	2286	1757	1718	3750	933	2240
<b>FORD Transit V348 (rear wheel drive)</b>																
UAP 390 (20-10006951)	4	3850	1750	2600	750	2000	5850	4586	7028	2845	2360	1737	1642	3954	933	2141

# Hobby



### Increase and reduction of load capacity for mobile homes

Hobby Model	Model	Type	Base vehicle	Motorisation <sup>5)</sup> Model	Chassis	Frame extension	Tow-bar	
							Towing bracket	Spherical head
<b>FORD Transit V347 (front wheel drive)</b>								
<b>T 500 GFSC</b>	Van	H2	FORD Transit FT 350 M	2.2 TDCi (85 kW)	Flat bottom	205914 lowered	SAWIKO 30LF70003P	Typ 05 (3009000500)
<b>T 500 FSC</b>	Van	H2	FORD Transit FT 350 M	2.2 TDCi (85 kW)	Flat bottom	205914 lowered	SAWIKO 30LF70003P	Typ 05 (3009000500)
<b>T 500 FSC LE</b>	Van	H2	FORD Transit FT 350 M	2.2 TDCi (103 kW)	Flat bottom	205914 lowered	SAWIKO 30LF70003P	Typ 05 (3009000500)
<b>TL 500 GESC</b>	Van Exclusive	H2	FORD Transit FT 350 L	2.2 TDCi (85 kW)	Flat bottom	205913 lowered	SAWIKO 30LF70001P	Typ 05 (3009000500)
<b>T 600 FC</b>	Siesta Exclusive	H2	FORD Transit FT 350 L	2.2 TDCi (85 kW)	Flat bottom	205821 level	SAWIKO 30LF70008P	Typ 04 (3009000400)
<b>T 650 FLC</b>	Siesta Exclusive	H2	FORD Transit FT 350 L	2.2 TDCi (85 kW)	Flat bottom	205823 level	SAWIKO 30LF70002P	Typ 04 (3009000400)
<b>T 555 AK GFSC</b>	Siesta	H2	FORD Transit FT 350 M	2.2 TDCi (85 kW)	Flat bottom	206381 level	SAWIKO 30LF70010P	Typ 04 (3009000400)
<b>T 555 AK GFSC LE</b>	Siesta	H2	FORD Transit FT 350 M	2.2 TDCi (103 kW)	Flat bottom	206381 level	SAWIKO 30LF70010P	Typ 04 (3009000400)
<b>T 600 AK KM</b>	Siesta	H2	FORD Transit FT 350 L	2.2 TDCi (85 kW)	Flat bottom	205822 level	SAWIKO 30LF70007P	Typ 04 (3009000400)
<b>T 650 AK GFM</b>	Siesta	H2	FORD Transit FT 350 L	2.2 TDCi (85 kW)	Flat bottom	205824 level	SAWIKO 30LF70009P	Typ 04 (3009000400)
<b>FORD Transit V348 (rear wheel drive)</b>								
<b>T 650 ESC LE</b>	Siesta Exclusive	H3	FT 350 L	2.4 TDCi (103 kW)	Ladder-type chassis frame	204310 level	BOSAL 3959-A	---

All measurements in [mm]

all weights in [kg]

- 1) incl. roof rail if it is standard equipment
- 2) without wing mirror, without side blinker
- 3) tow coupling is a special accessory. Please observe the maximum towing weight.
- 4) rear edge of traction unit to rear edge of back wall
- 5) 2,2 TDCi 85 kW (115 PS); 2,2 TDCi 103 kW (140 PS); 2,4 TDCi 103 kW (140 PS)
- 6) **2-point (lap) belt rack facing towards the rear (special accessory): UTP 620 (20-10006950)**

increased load due to Goldschmitt additional pneumatic spring  
 Reduction of load capacity to 3,500 kg.

# Hobby

Belt system	Seats	t.z.G. [kg]	Permissible front axle load	Permiss. rear axle load	Unbraked trailer load <sup>3)</sup>	Braked trailer load <sup>3)</sup>	Maximum towing weight	Length of super-structure <sup>4)</sup>	Total length <sup>1)</sup>	Height <sup>1)</sup>	Width <sup>2)</sup>	Front tread width	Rear tread width	Wheel base	Front projection	Rear projection <sup>1)</sup>
<b>FORD Transit V347 (front wheel drive)</b>																
UAP 324 (20-10006953)	4	3850	1750	2250	750	1000	4500	3701	5999	2710	2140	1757	1718	3300	933	1766
UAP 324 (20-10006953)	4	3850	1750	2250	750	1000	4500	3701	5999	2710	2140	1757	1718	3300	933	1766
UAP 324 (20-10006953)	4	3850	1750	2250	750	1000	4500	3701	5999	2710	2140	1757	1718	3300	933	1766
UAP 324 (20-10006953)	4	3850	1750	2250	750	1000	4500	4397	6750	2710	2180	1757	1718	3750	933	2067
MSP 500 (20-10005970)	3	3850	1750	2250	750	1000	4500	4083	6452	2830	2360	1757	1718	3750	933	1769
UAP 141 (20-10006948)	4	3850	1750	2250	750	1000	4500	4586	6955	2830	2360	1757	1718	3750	933	2272
UAP 325 (20-10007513)	4	3850	1750	2250	750	1000	4500	3699	5999	2940	2286	1757	1718	3300	933	1766
UAP 325 (20-10007513)	4	3850	1750	2250	750	1000	4500	3699	5999	2940	2286	1757	1718	3300	933	1766
UAP 380 (20-10006949) <sup>5)</sup>	4	3850	1750	2250	750	1000	4500	4031	6407	2940	2286	1757	1718	3750	933	1724
UAP 380 (20-10006949) <sup>5)</sup>	4	3850	1750	2250	750	1000	4500	4547	6923	2940	2286	1757	1718	3750	933	2240
<b>FORD Transit V348 (rear wheel drive)</b>																
UAP 390 (20-10006951)	4	3500	1750	2600	750	2000	5850	4586	7028	2845	2360	1737	1642	3954	933	2141

Hobby

## 13.4 Tyres and rims for basic motor home vehicles

Hobby Model	Series	Techn. perm. overall weight [kg]	Perm. axle load front	Perm. axle load rear	Basic model with steel rims			Basic model with LM rims			
					Tyre size	Wheel attachment *	Steel rims	Tyre size	Wheel attachment *	LM rims	Rim designation
T 500 GFSC	Van	3500	1750	2250	215/75 R 16 C	5 / 65 / 160	5½ J x 16, ET 56	215/75 R 16 C	5 / 65 / 160	At present, the manufacturer cannot supply light alloy rims.	
T 500 FSC	Van	3500	1750	2250	215/75 R 16 C	5 / 65 / 160	5½ J x 16, ET 56	215/75 R 16 C	5 / 65 / 160	At present, the manufacturer cannot supply light alloy rims.	
T 500 FSC LE	Van	3500	1750	2250	215/75 R 16 C	5 / 65 / 160	5½ J x 16, ET 56	215/75 R 16 C	5 / 65 / 160	At present, the manufacturer cannot supply light alloy rims.	
TL 500 GESG	Van Exclusive	3500	1750	2250	215/75 R 16 C	5 / 65 / 160	5½ J x 16, ET 56	215/75 R 16 C	5 / 65 / 160	At present, the manufacturer cannot supply light alloy rims.	
T 600 FC	Siesta Exclusive	3500	1750	2250	215/75 R 16 C	5 / 65 / 160	5½ J x 16, ET 56	215/75 R 16 C	5 / 65 / 160	At present, the manufacturer cannot supply light alloy rims.	
T 650 FLC	Siesta Exclusive	3500	1750	2250	215/75 R 16 C	5 / 65 / 160	5½ J x 16, ET 56	215/75 R 16 C	5 / 65 / 160	At present, the manufacturer cannot supply light alloy rims.	
T 555 AK GFSC	Siesta	3500	1750	2250	215/75 R 16 C	5 / 65 / 160	5½ J x 16, ET 56	215/75 R 16 C	5 / 65 / 160	At present, the manufacturer cannot supply light alloy rims.	
T 555 AK GFSC LE	Siesta	3500	1750	2250	215/75 R 16 C	5 / 65 / 160	5½ J x 16, ET 56	215/75 R 16 C	5 / 65 / 160	At present, the manufacturer cannot supply light alloy rims.	
T 600 AK KM	Siesta	3500	1750	2250	215/75 R 16 C	5 / 65 / 160	5½ J x 16, ET 56	215/75 R 16 C	5 / 65 / 160	At present, the manufacturer cannot supply light alloy rims.	
T 650 AK GFM	Siesta	3500	1750	2250	215/75 R 16 C	5 / 65 / 160	5½ J x 16, ET 56	215/75 R 16 C	5 / 65 / 160	At present, the manufacturer cannot supply light alloy rims.	
T 650 ESC LE	Siesta Exclusive	3850	1750	2600	185/75 R 16 C	6 / 139 / 178	5 J x 16, ET 107	---	---	---	---

\* No. of tyre bolts / centralising collars / bolt circle

Permissible light alloy rims for the Ford Transit (front wheel drive): CWC65640 and CG 65650 (Borbet), measurements: 6½ J x 16, ET 60 (presently only available from accessory dealers; not available for original equipment manufacturers)

# Hobby

### Tyres and rims for loaded motor homes

Hobby Model	Series	Techn. perm. overall weight [kg]	Perm. axle load front	Perm. axle load rear	Basic model with steel rims			Basic model with LM rims			
					Tyre size	Wheel attachment *	Steel rims	Tyre size	Wheel attachment *	LM rims	Rim designation
T 500 GFSC	Van	3850	1750	2250	215/75 R 16 C	5 / 65 / 160	5½ J x 16, ET 56	215/75 R 16 C	5 / 65 / 160	At present, the manufacturer cannot supply light alloy rims.	
T 500 FSC	Van	3850	1750	2250	215/75 R 16 C	5 / 65 / 160	5½ J x 16, ET 56	215/75 R 16 C	5 / 65 / 160	At present, the manufacturer cannot supply light alloy rims.	
T 500 FSC LE	Van	3850	1750	2250	215/75 R 16 C	5 / 65 / 160	5½ J x 16, ET 56	215/75 R 16 C	5 / 65 / 160	At present, the manufacturer cannot supply light alloy rims.	
TL 500 GESC	Van Exclusive	3850	1750	2250	215/75 R 16 C	5 / 65 / 160	5½ J x 16, ET 56	215/75 R 16 C	5 / 65 / 160	At present, the manufacturer cannot supply light alloy rims.	
T 600 FC	Siesta Exclusive	3850	1750	2250	215/75 R 16 C	5 / 65 / 160	5½ J x 16, ET 56	215/75 R 16 C	5 / 65 / 160	At present, the manufacturer cannot supply light alloy rims.	
T 650 FLC	Siesta Exclusive	3850	1750	2250	215/75 R 16 C	5 / 65 / 160	5½ J x 16, ET 56	215/75 R 16 C	5 / 65 / 160	At present, the manufacturer cannot supply light alloy rims.	
T 555 AK GFSC	Siesta	3850	1750	2250	215/75 R 16 C	5 / 65 / 160	5½ J x 16, ET 56	215/75 R 16 C	5 / 65 / 160	At present, the manufacturer cannot supply light alloy rims.	
T 555 AK GFSC LE	Siesta	3850	1750	2250	215/75 R 16 C	5 / 65 / 160	5½ J x 16, ET 56	215/75 R 16 C	5 / 65 / 160	At present, the manufacturer cannot supply light alloy rims.	
T 600 AK KM	Siesta	3850	1750	2250	215/75 R 16 C	5 / 65 / 160	5½ J x 16, ET 56	215/75 R 16 C	5 / 65 / 160	At present, the manufacturer cannot supply light alloy rims.	
T 650 AK GFM	Siesta	3850	1750	2250	215/75 R 16 C	5 / 65 / 160	5½ J x 16, ET 56	215/75 R 16 C	5 / 65 / 160	At present, the manufacturer cannot supply light alloy rims.	
T 650 ESC LE	Siesta Exclusive	---	---	---	---	---	---	---	---	---	---

\* No. of tyre bolts / centralising collars / bolt circle

increased load due to Goldschmitt additional pneumatic spring  
 No increased load possible at the factory.

Permissible light alloy rims for the Ford Transit (front wheel drive): CWC65640 and CG 65650 (Borbet), measurements: 6½ J x 16, ET 60 (presently only available from accessory dealers; not available for original equipment manufacturers)

**Hobby**

### 13.5 Accessory weights

Object	Weight [kg]	Object	Weight [kg]
FORD convenience package	44.5	Outside shower	0.5
Hobby start-up package	54.5	Oven with grill and light	14.5
Hobby all-inclusive package	68.0	Oven with grill, light and electric ignition	16.0
Additional gel battery	28.0	Pilot seats, pivoted	4.8
Additional loudspeaker	2.0	Radio alarm system with gas warner	1.0
Additional socket	0.5	Rear ladder	12.0
Air conditioner 2200, 230V	34.0	Rear stanchions	6.0
Battery sensor	0.9	Reverse drive video system	2.0
Bedspread	1.5	Roof bonnet with electric fan	8.5
Bicycle carrier for 2 bicycles	8.0	Roof bonnet, Midi-Heki	4.5
Bicycle carrier for 3 bicycles	9.0	Roof bonnet, Midi-Heki, electric	5.5
Comfortable bed system incl. memory foam mattress	2.7	Roof rail	6.0
DuoComfort remote indicator	0.3	SAT antenna 65 cm	16.0
DuoComfort	3.0	SAT antenna 85 cm	18.0
DVD/CD radio with sat-nav and camera	3.2	SAT receiver 2	2.0
Elegant wooden dashboard	0.5	Special metallic silver paintwork	3.0
External socket for gas	1.0	Telescopic arm for flat screen TV	3.0
Fume hood	3.0	Telescopic ladder	2.8
Gas level indicator	1.0	Tow coupling for Siesta/ Siesta Exclusive	35.0
Gas warner	1.0	Tow coupling	3.0
Gel batteries, two	55.0	Truma Combi 6 E	1.1
GOLDSCHMITT additional pneumatic suspension	12.0	WEBASTO auxiliary heating	9.5
Hobby multimedia package	23.0	Winter cover for refrigerator grid	0.5
Hobby surround sound system ELAC	4.5		
Interior upholstery for driver's and passenger's seats	3.0		
Leather upholstery	12.0		
Motorcycle mount	36.0		
Mud flaps, rear	2.0		
Outer tent socket	0.4		

## Hobby

**Hobby**

## Index

### A

Access ladder  
 bed in external storage  
 locker/alcove 06-19  
 Accessories  
 upkeep 11-5  
 Additional loads 03-3  
 Additional pneumatic spring  
 03-6  
 Airing 11-1  
 Alcoves 06-18  
 Anti-freeze measures 11-5  
 Auxiliary heating 10-8  
 Awning 05-12

### B

Bar 06-5  
 Basic equipment 03-1  
 Battery charger  
 location 07-12  
 Battery circuit breaker 07-2  
 Bed conversion 06-12  
 Bed ladder  
 foldaway 06-19  
 Berths 06-13  
 Bicycle carrier 05-11  
 Boot lid 05-9  
 Brakes 02-6, 04-8  
 Breakdown of devices 07-11

### C

Car jack 02-8  
 Carrier 05-11

Changing the tire 04-7  
 Charging process 07-7  
 deep discharge protection 07-8  
 protecting devices 07-8  
 when engine is running 07-9  
 Chassis 03-1  
 Checking the gas system 09-1  
 Chocks 02-9  
 Choosing a parking space 02-9  
 Condensation 11-1  
 Control panel 07-1  
 Converting the L-shaped seating  
 arrangement 06-27  
 Converting the transverse seat  
 06-12  
 Cushion arrangements 06-13

### D

Darkening system  
 driver's cab 06-22  
 Day and night positions  
 overview 06-32  
 Deep discharge protection 07-7  
 Distribution module 07-5  
 Doors and flaps  
 interior 06-1  
 Doors  
 opening and closing 05-5  
 Driving 02-7  
 in curves 02-7  
 in reverse 02-6  
 sparing the tires 04-1  
 Driving economically 02-7  
 Driving in curves 02-7  
 Driving in reverse 02-6

### E

Electric heating system 10-7  
 Electric power supply 07-6  
 Electric power supply unit 07-7  
 Electrical devices, installation  
 safety tips 07-1  
 Electrical system  
 fuse protection 07-11  
 Emergency equipment 02-8  
 first-aid kit 02-8  
 warning triangle 02-9  
 Entrance door 05-5  
 Entrance step 03-5  
 Environment 12-1  
 disposal 12-3  
 excrements 12-2  
 picnic spots 12-3  
 rubbish 12-3  
 waste water 12-2  
 Environmental protection 12-1  
 Exhaust fumes 09-2  
 External cleaning 11-2  
 polishing 11-3  
 waxing 11-3  
 External gas connection 05-10  
 External socket 07-7

### F

Fire protection 02-1  
 First-aid kit 02-8  
 Fittings 03-8  
 Flaps  
 opening and closing 06-1  
 Flush toilet 08-5  
 Forced de-aerating 05-3

Forced ventilation 05-3  
 Freezer compartment 10-11  
 Fresh water tank 08-2  
 to empty 08-2  
 Frost control 10-3  
 Fume hood 10-15  
 Furniture doors 06-2  
 Furniture surfaces  
 upkeep 11-4  
 Fuse protection of electrical  
 system  
 12V circuits 07-11

### G

Gas 09-1  
 Gas bottle container 09-3  
 Gas cooker 10-12  
 to operate 10-13  
 Gas supply 09-3  
 Gas system  
 exhaust fumes 09-2  
 fixtures and changes 09-1  
 inspection 09-1  
 regulator knobs and valves  
 09-2  
 shut-off valves and valves 09-4  
 General inspection 02-2

### H

Hanging table 06-8  
 Head rests  
 setting the height 06-15  
 Heating  
 location of control panel 10-2  
 operating in summer 10-4

# Hobby

operating in winter 10-4  
to switch off 10-6  
to operate 10-4  
Hinged windows 06-19  
Hot water supply 08-5

**I**

Insect screen 06-20  
Intelligent Battery Sensor 07-4

**K**

Kitchen extension 06-10  
Kitchen pull-out 06-3

**L**

Levelling supports 03-4  
Loading 02-5  
roof rail 05-10

**M**

Mains connection 07-6  
Maintenance intervals 11-1  
Maintenance  
brake system 04-8  
Mass when ready to drive  
03-1  
Modular battery 07-10  
changing the battery 07-10  
features 07-10  
location 07-10  
Modular battery 07-11

**N**

Navigation 07-12

**O**

Operating in winter 11-7  
anti-freeze measures 11-8  
ventilation 11-7  
Operating the cooker 10-13  
Outside shower  
water supply 08-8  
Overflow valve  
fresh water tank 03-3

**P**

Petrol cap 05-9  
Pillared table 06-7  
Power saving 02-10  
Preparing the vehicle 02-3  
Profile depth 04-2  
Push lock 06-4

**R**

Rear external storage locker 02-6  
Rear view camera 07-12  
Redirecting electrical devices  
02-9  
Reduction of load capacity 03-2  
Refrigerator 10-9  
12V operation 10-9  
230V operation 10-10  
air supply 05-3  
door lock 10-10  
operating on gas 10-10  
types of operation 10-9  
Refuelling 02-7  
Registration 02-2  
Resin stains 10-3  
Retractable bed 06-17

Rims 04-3  
Roof bonnets 06-23  
Roof load 02-6  
Roof rail 05-10  
Rooftop air conditioning 10-16

**S**

Safety belts in the superstructure 06-28  
Seats in the superstructure  
06-27  
Seats  
overview 06-29  
Securing the vehicle 02-9  
Service flaps 05-1  
Shunting 02-6  
Skylight 06-21  
Sunshade 06-21  
Switching valve 09-5

**T**

Table extension 06-9  
Tables 06-7  
Tar stains 11-3  
Technically permissible  
maximum weight 03-1  
Tire pressure 04-2  
Tire pressure values 13-2  
Tires 04-1  
Toilet flap 05-7  
Toilet  
upkeep 11-4  
Toilet  
emptying the cassette 08-7  
use of 08-5

TV mount 06-6

**U**

Upkeep 11-2  
accessories 11-5  
chair and cushion covers,  
curtains 11-3  
fitted carpets 11-4  
furniture surfaces 11-4  
PVC flooring 11-4  
toilet 11-4  
windows and doors 11-3

**V**

Valve for waste water tank 08-4  
Valves 09-2  
Vehicle keys 05-5  
Ventilation grids 05-4

**W**

Warning triangle 02-8  
Waste water tank 08-2  
to empty 08-4  
Water filler necks 05-9  
Water filter 08-3  
Weights for accessories 13-9  
Widening the beds 06-17  
Windows 06-20  
Winter lay up 11-5  
external superstructure and the  
base vehicle 11-5  
interior 11-7  
tanks and containers 11-6  
Winter tires 04-1

# Hobby



### Calculating masses for HOBBY motor homes

The following table enables you to calculate the mass of your own motor home on the basis of the mass data given in this manual. This calculation must always result in a positive remaining load in order to fulfil current legal requirements.

To determine your remaining load, simply subtract the "mass when the vehicle is ready to start", the "conventional load", all "additional equipment" as well as your "personal luggage" from the "technically permissible overall mass". Simply enter the date for your personal motor home in the table on the next page. If you have any questions or if anything is unclear, your HOBBY dealer will be pleased to assist you.

Your  
HOBBY Motor Home Plant  
Ing. Harald Striewski GmbH

# Hobby

**Model:**

<b>Technically permissible overall mass:</b>		
<b>Mass when the vehicle is ready to start</b> (incl. gas, water, electricity, driver and fuel):	-	
<b>Conventional load</b> (no. of seats [excl. driver] x 75 kg):	-	
<b>Additional equipment:</b>		
1.)	-	
2.)	-	
3.)	-	
4.)	-	
5.)	-	
6.)	-	
7.)	-	
8.)	-	
9.)	-	
10.)	-	
11.)	-	
12.)	-	
13.)	-	
14.)	-	
15.)	-	
<b>Personal luggage</b> = (10 x N) + (10 x L):	-	
N - Total number of seats (incl. driver)		
L - Length of vehicle in meters		
<b>Remaining load:</b>		



Under no circumstances may the technically permissible overall mass of the motor home be exceeded!

# Hobby