



**OPERATOR'S
HANDBOOK**

CH SERIES



MACK TRUCKS INC. • HISTORICAL MUSEUM • RE-ISSUE 2008

TS71095
CH SERIES

© MACK TRUCKS INC. 1994

PRINTED IN U.S.A.

TS71095

CH

OPERATOR'S
HANDBOOK

TS71095

*THE INFORMATION CONTAINED IN THIS HANDBOOK
IS CURRENT AT TIME OF PUBLICATION.*

MACK TRUCKS, INC.® RESERVES THE RIGHT TO
MAKE CHANGES WITHOUT PRIOR NOTIFICATION.



NOTES





TABLE OF CONTENTS



REPORTING SAFETY DEFECTS	3
CANADIAN CONSUMER COMPLAINTS	3
CUSTOMER SERVICE	4
TO THE OWNER	8
ADVISORY LABELS	9
SIGNAL WORD LOCATIONS	10
SERVICE LITERATURE	22
WARRANTY	24
UNIT IDENTIFICATION	26
ENGINE INFORMATION PLATE LOCATION	28
SAFETY CERTIFICATION LABEL	30
DOORS	32
CAB ENTRY (<i>DRIVER'S SIDE</i>)	33
CAB EXIT (<i>DRIVER'S SIDE</i>)	36
CAB ENTRY (<i>PASSENGER'S SIDE</i>)	38
CAB EXIT (<i>PASSENGER'S SIDE</i>)	41
SEAT BELTS	43
TELL-TALES	49
INSTRUMENT PANEL ARRANGEMENT	50
VARIABLE SPEED CONTROL-IF SO EQUIPPED ...	60
HEATER AND AIR CONDITIONER	68
TURN SIGNAL STICK	70
COMBINATION STARTER / ELECTRIC SWITCH ...	72
STEERING WHEEL ADJUSTMENT	73
CIRCUIT BREAKERS	74
HOOD	76
A GUIDE TO SAFE, ECONOMICAL OPERATION ...	83
BREAK IN	84
OIL CHECK	85
DAILY INSPECTION	86
STARTING	88
COOLING SYSTEM	95
TRANSMISSION	105
BRAKES	139
TIRE PRESSURE CHART	145
WHEEL INSPECTION	146
JUMP STARTING AN ENGINE	149
BULB CHART	152



NOTES





SAFETY



REPORTING SAFETY DEFECTS

If you believe that your vehicle has a defect which could cause a crash or could cause injury or death, you should immediately inform the National Highway Traffic Safety Administration (NHTSA) in addition to notifying Mack Trucks, Inc.

If NHTSA receives similar complaints, it may open an investigation, and if it finds that a safety defect exists in a group of vehicles, it may order a recall and remedy campaign. However, NHTSA cannot become involved in individual problems between you, your dealer, or Mack Trucks, Inc.

To contact NHTSA, you may either call the Auto Safety Hotline toll-free at 1-800-424-9393 (or 366-0123 in Washington, D.C. area) or write to: NHTSA, U.S. Department of Transportation, Washington, D.C. 20590. You can also obtain other information about motor vehicle safety from the Hotline.

CANADIAN CONSUMER COMPLAINTS

For Canadian consumer complaints, refer your complaint to Transport Canada—Department of Public Complaints, Recalls and Investigations.

Call (613)-993-9851.



CUSTOMER SERVICE



Your satisfaction with the vehicle or service parts you purchase, and the service you receive at a Mack Trucks branch, distributor or service dealer, is our most important concern.

If questions or complaints arise, we suggest that you first discuss the matter with the service manager at the Mack facility involved. If you are not satisfied with the service manager's response, seek out the branch manager, principal or general manager of the distributorship, explain the situation and request assistance. Those requiring assistance at a service dealer should speak with the owner of the establishment.

If for any reason you need further assistance after dealing with the personnel at a Mack branch, distributor or service dealer, contact the nearest Mack regional service office and address your problem or request to our regional service manager. The regional service manager has the responsibility and the authority to recommend action on most cases and (with the aid of relevant district service personnel) will make every effort to conduct a fair review of your situation.





CUSTOMER SERVICE



The addresses and telephone and fax numbers of the Mack Truck regional offices are:

UNITED STATES



EASTERN REGION
2166 S. 12TH STREET
AX 4 B
P. O. BOX "M"
ALLENTOWN, PA 18105
(215) 439-3551
FAX: (215) 439-2220

SOUTHERN REGION
5775-B GLENRIDGE DRIVE
SUITE 540
ATLANTA, GA 30328
(404) 252-5227
FAX: (404) 252-4482

CENTRAL REGION
101 BURR RIDGE PARKWAY
BURR RIDGE, IL 60521
(708) 920-8788
FAX: (708) 920-8798

WESTERN REGION
5605 N. MACARTHUR BLVD.
#550
P. O. BOX 165408
IRVING, TX 75016-5408
(214) 518-1614
FAX: (214) 550-0389

CANADA



EASTERN REGIONAL OFFICE
MACK CANADA INC.
1350 THE QUEENSWAY
TORONTO, ONTARIO
M8Z 1S5
TEL: (416) 255-1311
TLX: 06967510
FAX: (416) 255-4209

WESTERN REGIONAL OFFICE
MACK CANADA INC.
#101, 566 LOUGHEED HWY.
COQUITLAM, BC
V3K S3S
TEL: (604) 939-2261
TLX: 04351266
FAX: (604) 939-2367

AUSTRALIA



P. O. BOX 364
DARRA 4076, QUEENSLAND
AUSTRALIA
61-7-375-3333
FAX: 61-7-375-3469
OR: 61-7-375-4010

INTERNATIONAL



P. O. BOX 1782
ALLENTOWN, PA 18105-1782
(215) 439-2470
FAX: (215) 439-3800



CUSTOMER SERVICE



If additional assistance is necessary, Mack Trucks, Inc. maintains a corporate customer service department staffed by experienced personnel, whose sole purpose is to aid the customer who needs information or assistance which isn't provided at the local or regional level.

THE CUSTOMER SERVICE DEPARTMENT PHONE NUMBER IS (215) 439-3961.

When contacting our regional service offices or customer service department, it is imperative that you provide them with the following information:

VEHICLE IDENTIFICATION NUMBER (VIN). You will find this 17 digit number located on a plate on the driver's door latch post. You can also find it behind the front axle on the right front frame rail.

MODEL AND YEAR OF VEHICLE.

DATE VEHICLE WAS PURCHASED AND PUT INTO SERVICE.

DATE OF REPAIR AND REPAIR MILEAGE.

BRANCH, DISTRIBUTOR OR SERVICE DEALER who sold and/or serviced the vehicle.

DESCRIPTION of unresolved service complaint or inquiry.

SUMMARY OF ACTION TAKEN TO DATE by the branch, distributor or service dealer as well as our regional service office.

NAMES (if known) OF INDIVIDUALS contacted at the branch, distributor or service dealer and Mack Truck's regional service office.





IMPORTANT



Keep this handbook with this vehicle at all times to insure that each owner and/or operator will have access to all pertinent information.

This handbook is referred to as the CH SERIES OPERATOR'S HANDBOOK. We call it that because it covers the entire line of CH vehicles. The basic configuration of these models is a conventional styled, aerodynamic cab.

We at MACK TRUCKS, INC.® hope you will be happy with your new CH, and that you see many years of troublefree driving.

V-MAC

VEHICLE MANAGEMENT AND CONTROL SYSTEM

The Vehicle Management and Control System, referred to in this handbook as V-MAC, is an electronic engine control system with the ability to control and manage certain functions of the vehicle as well as monitor and store information.

Your vehicle may or may not be equipped with V-MAC. Vehicles equipped with V-MAC may have switches or controls located in slightly different locations than vehicles without V-MAC.

A complete description of the system components and their functions and locations on the vehicle is contained in the V-MAC Operator's Guide, TS725.

If your vehicle has V-MAC, refer to TS725 for specific information for V-MAC.



TO THE OWNER



IN APPRECIATION

Thank you for buying a MACK® truck. With proper care and maintenance, your new CL will help you gain a competitive edge with its aerodynamic design, its fuel efficient drive train combinations, low maintenance extended service intervals and eventually a good resale value. Maintenance and lubrication are covered in another manual, TS494. Important information is also found in the Emission Control Systems booklet, TS505.

MACK TRUCKS, INC. WOULD LIKE TO EMPHASIZE THE IMPORTANCE THE DRIVER WILL PLAY IN THE LIFE OF THE TRUCK. ONLY TRAINED AND INFORMED DRIVERS FAMILIAR WITH HEAVY DUTY TRUCK-TRACTORS SHOULD OPERATE THIS VEHICLE.

This manual was prepared to help the driver in the daily operation of the truck. Please read it before you put the truck into service. Pay particular attention to the advisory labels which are referred to throughout this manual. They are in this handbook to bring attention to some things of which you may not be aware.

The service manager of your local MACK dealership will answer any question you may have and help you locate serial numbers on major components in order to fill in the blanks in the section on Unit Identification.

Information and illustrations in this manual are based on latest production usage at time of printing and are subject to change without prior notice.

Your new vehicle is built to conform to all federal standards and regulations applicable at its time of manufacture.





ADVISORY LABELS



THE READER MAY FIND ANY OR ALL OF THE FOLLOWING LABELS USED IN THIS PUBLICATION. AN UNDERSTANDING OF THEIR USE, AS GIVEN BELOW WILL AID THE READER.

ADVISORY LABELS

SERVICE HINT

A helpful suggestion which will make the servicing being performed, quick and easy.

NOTE

An operating procedure, practice, condition, etc., which is essential to emphasize.

⚠ CAUTION

Directs attention to unsafe practices which could result in damage to equipment and possible subsequent personal injury or death if proper precautions are NOT taken.

⚠ WARNING

Directs attention to unsafe practices which could result in personal injury or death if proper precautions are NOT taken.

⚠ DANGER

Directs attention to unsafe practices and/or existing hazards which will result in personal injury or death if proper precautions are NOT taken.



SIGNAL WORD LOCATIONS

Throughout this book you will find Notes, Warnings, Cautions and Dangers (Advisory Labels) and their accompanying information. The vehicle also has Caution and Warning Labels which are placed in various locations on the vehicle to alert the driver, operator or service technician to situations which could harm himself or equipment. The Caution and Warning Labels shown are applicable to the CH model chassis at time of publication and they are representative of what can be typically found on a CH. They are there for your benefit. Please look through this section and make a mental note of the labels, their locations and what they explain.

Replace any label that is damaged.





ADVISORY LABEL LOCATION



SERVICING WARNING LABEL 4MR3191M

The Servicing Warning Label, designated as 4MR3191M, is located on the cab firewall (both left and right sides). The hood must be tilted to see the label.

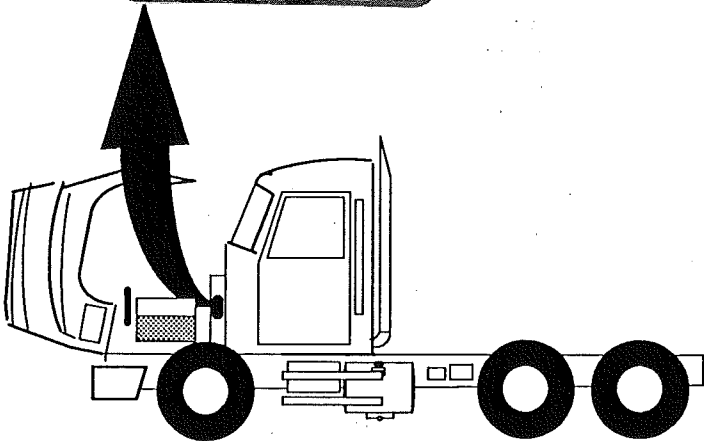
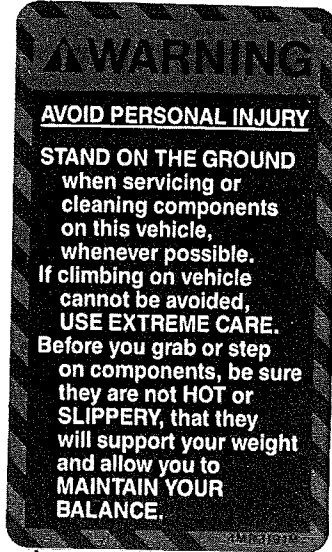



ADVISORY LABEL LOCATION



HOOD PROP CAUTION LABEL 4MR2921

The Hood Prop Caution Label is located on the right side frame rail. Specifically, it can be found in the location shown in the illustration below.

NOTE

In addition to the hood prop caution label, there is also an instruction label mounted on the hood, just behind the bulldog, to remind the operator to release the hood prop before closing.

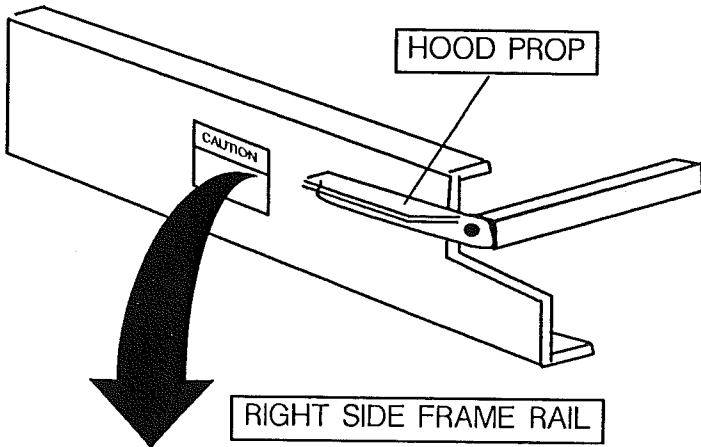



ADVISORY LABEL LOCATION



BATTERY DISCONNECT SWITCH

CAUTION NAMEPLATE 4MR2799M

The Battery Disconnect Switch Caution Nameplate, designated as 4MR2799M, is typically located on the left side frame rail near the battery box.

BATTERY JUMPSTART WARNING LABEL 4MR2797

The Battery Jumpstart Warning Label is located on the battery hold-down. The battery hold-down is under the box cover and can not be seen unless you remove the cover.

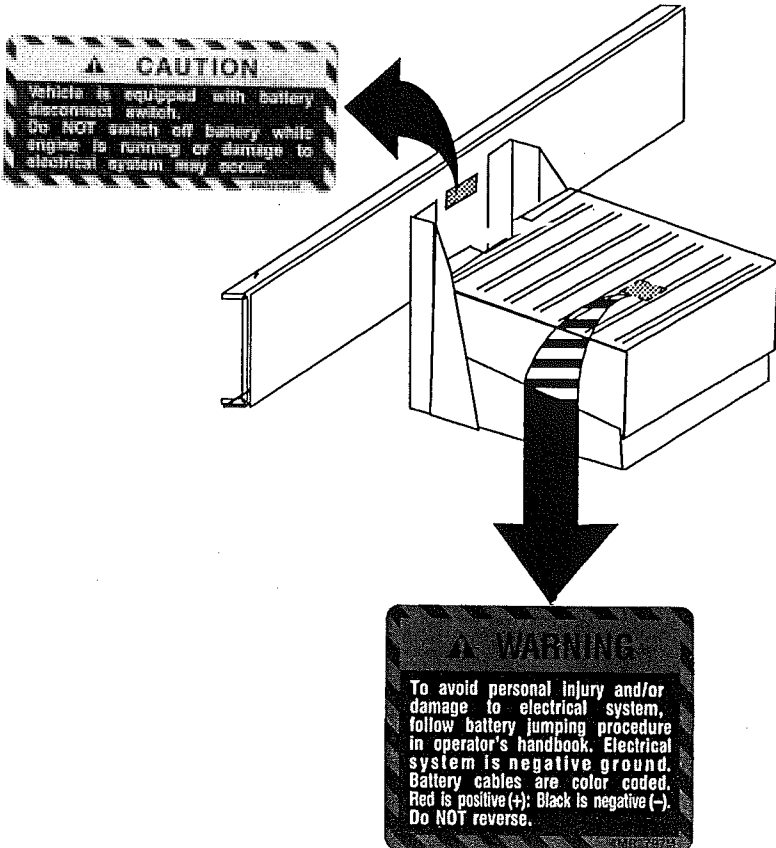



ADVISORY LABEL LOCATION



FUEL TANK VENTED CAP CAUTION LABEL .. 4MR2798

The Fuel Tank Vented Cap Caution Label, designated as 4MR2798, is typically located on the fuel tank in the vicinity of the vented fill cap.

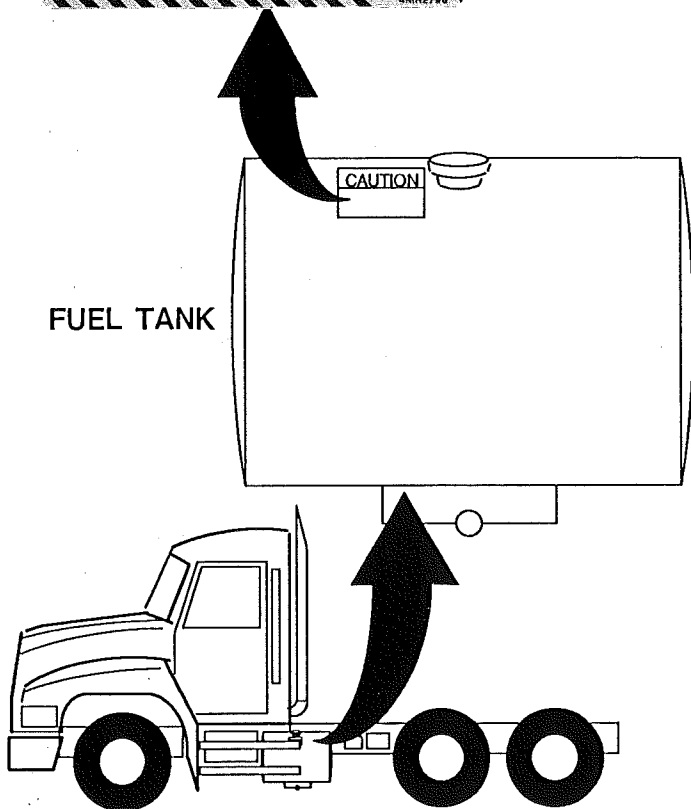



ADVISORY LABEL LOCATION



HUCK FASTENER CAUTION LABEL 4MR3208M

(This label will be affixed only if the chassis utilizes Huck frame fasteners.)

The Huck Fastener Caution Labels (one is affixed to each side of the chassis) is located on the outboard side of each frame rail in an open area ahead of the rear axle(s).

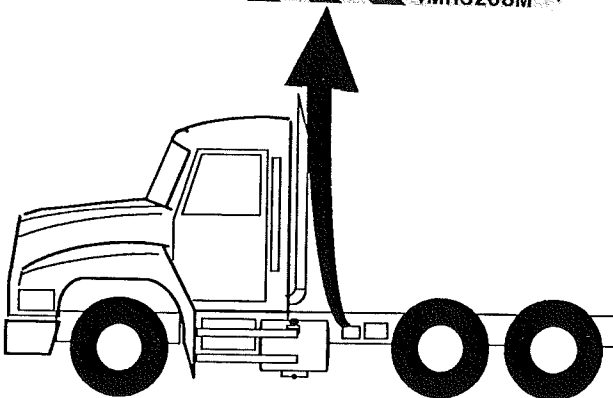



ADVISORY LABEL LOCATION



FRAME DAMAGE CAUTION LABEL 4MR2801

The Frame Damage Caution Labels, (two are affixed to each chassis) are typically located on the outboard side of the frame rails (left and right sides) in an open area ahead of the rear axle(s).

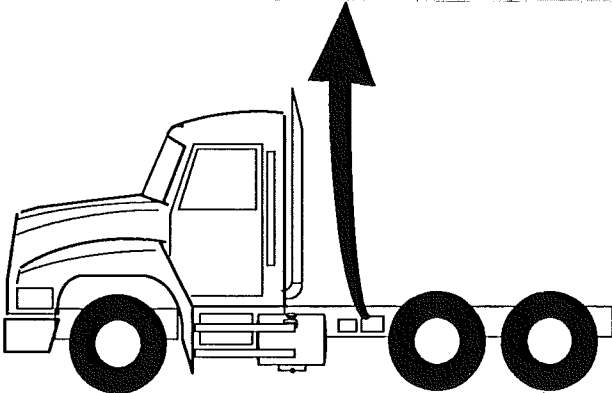
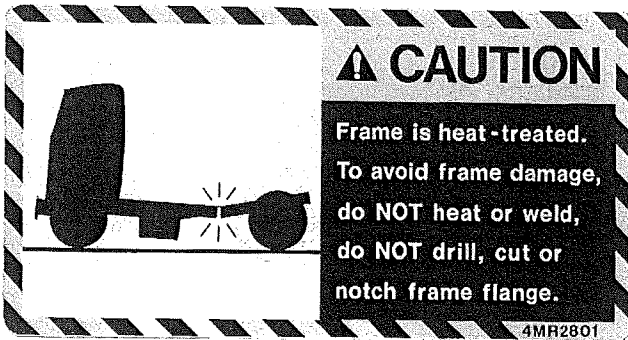



ADVISORY LABEL LOCATION



CAB ENTRY AND EXIT WARNING LABEL 4MR3190

The Cab Entry and Exit Warning Label, designated as 4MR3190, is typically located on the left hand and right hand door lock post edges, about one-third of the way up from the bottom.

STEP WARNING LABEL 4MR2821M

The Step Warning Label, designated as 4MR2821M, is typically located on the right and left top step.

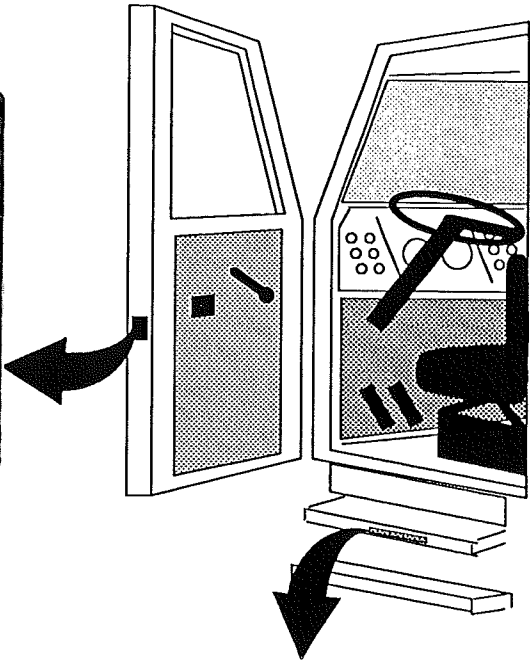



ADVISORY LABEL LOCATION



OPERATION WARNING LABEL 4MR3211M
 OPERATION WARNING LABEL 4MR3216M
 (4MR NUMBER DEPENDS ON THE TYPE OF ENGINE INSTALLED IN THE TRUCK)

The Operation Warning Label, designated as either 4MR3211M or 4MR3216M, depending on the engine installed in the truck, is typically located on the driver's sun visor (the left side when pulled into a down position).

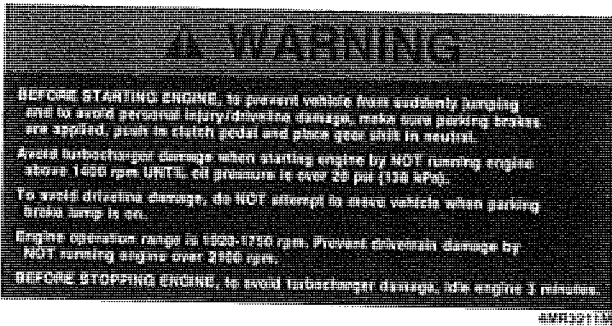
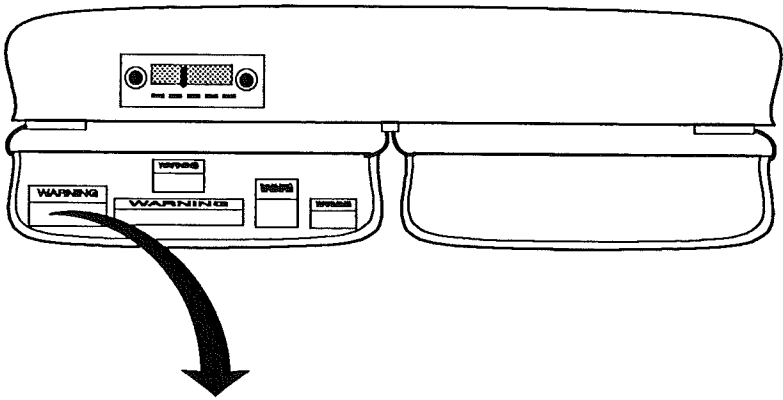



ADVISORY LABEL LOCATION



WINTERFRONT CAUTION LABEL 4MR2855

The Winterfront Caution Label, designated as 4MR2855, is typically located on the driver's sun visor.

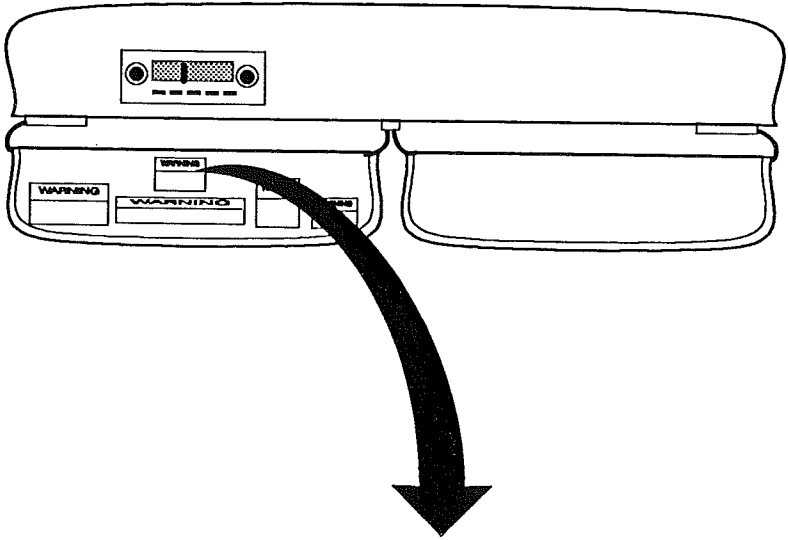

▲ CAUTION

Use of winterfront is NOT recommended. It can cause high exhaust temperature and serious engine damage. If one is to be installed, a Mack-approved pyrometer MUST also be installed. Do NOT exceed the temperature limit shown on pyrometer. To reduce temperature, open winterfront, downshift or reduce engine power.



ADVISORY LABEL LOCATION



V-MAC SHUTDOWN SYSTEM

WARNING LABEL 4MR3250

The V-MAC Shutdown System Warning Label is typically located on the driver's side sun visor.

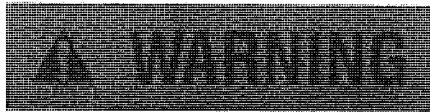
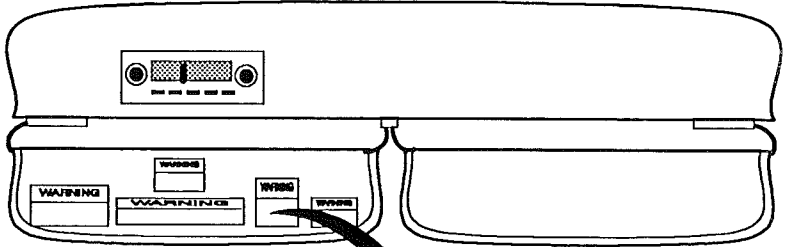

Engine Shutdown System works **AUTOMATICALLY**. If buzzer or warning light comes on, **QUICKLY** get vehicle safely off roadway. Failure to do so may result in injury to you or others due to power loss to vehicle systems. Pushing Shutdown Override Button will provide an extra 30 seconds of engine operation **ONLY ONE TIME**. See operation manual.

4MR3250M





ADVISORY LABEL LOCATION



POWER TAKE-OFF CAUTION LABEL 4MR2887

The Power Take-Off Caution Label is typically located on the dashboard. It can be found in the location shown in the illustration below.

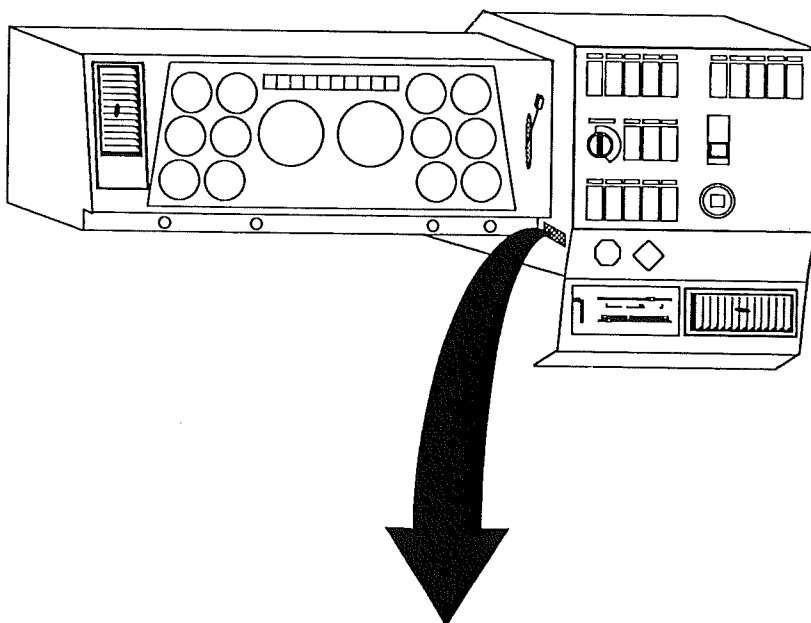

STATIONARY PTO OPERATION

Push in clutch pedal; Shift to neutral; Apply parking brake.
TURN NEUTRAL SWITCH ON. Shift to desired gear (See caution below).
Let out clutch pedal. Follow separate instructions for turning on pto.

ROAD OPERATION

Push in clutch pedal. Shift to neutral. Turn off neutral switch.

▲ CAUTION

Very high pto speed causes equipment damage.
Select lowest gear that provides satisfactory operation. 4MR2887



SERVICE LITERATURE



For customers who would like to know more about servicing their new Mack truck, several options are available to you. We offer three different types of literature which are described below. Decide which type fits your needs and order from your local branch or distributor.

NOTE

Mack Trucks, Inc. would like to point out the importance of properly servicing this truck. Servicing, repair and replacements must be done by certified licensed mechanics in accordance with pertinent Mack literature.

TS576-Mack Component Service Manual—A general collation containing numerous sections covering the service of engines, fuel system, transmissions, front and rear axles, cabs, electrical and many other systems and components on your vehicle.

Individual Master Manual Sections—Each manual contains complete overhaul, repair and other technical information for the component. Specify section number, title and quantity. Order one at a time if you prefer.

TS473-Custom Truck Service Manual—A tailor made service manual covering a specific vehicle or General Sales Order (GSO). When ordering this service manual, the complete model and chassis serial number must be supplied.





NOTES





WARRANTY



CAUTION

Any unauthorized adjustments of the injection pump and governor settings, other than as specified, can cause serious damage to the engine.

INJECTION PUMP AND GOVERNOR SETTING

Please be aware of the hazards of attempting to increase the power of the diesel engine in your chassis by adjusting injection pump and governor settings. Standard specifications for injection pump and governor settings permit the maximum allowable engine output. Adjustments of the injection pump and governor settings, other than as specified, can cause serious damage to the engine. In some engines, improper adjustments generally produce visual warnings of overfueling, excessive fuel consumption and smoke. The turbocharged diesel engine usually does not. The possibility of damage from improper adjustments is greater in the turbocharged diesel engine because the usual warning signs may not be present.

In the event that damage results from such unauthorized adjustments, as evidenced by improper settings in the injection pump and governor assembly, or broken fastener seals of the same, the cost of repairing such damage WILL NOT BE COVERED under the Mack Standard Vehicle Warranty.





WARRANTY



AIR BRAKE SYSTEM

The Mack Standard Vehicle Warranty applies to the air brake system, as set forth in the Warranty, but only if the air brake system has not been subjected to unauthorized additions, deletions or modifications. If any such unauthorized additions, deletions or modifications are performed to the air brake system, Mack Trucks, Inc.[®] disclaims any and all liability for any loss or damage arising out of a malfunction of the air brake system.

If any unauthorized additions, deletions or modifications are made to any portion of the air brake system which is required by Federal Motor Vehicle Safety Standards, Mack Trucks, Inc.[®] makes no representation as to conformity with the Standards.

For complete warranty information, refer to Pedigree Protection Plan (Mack manual number TS468) or Standard Vehicle Warranty (Form FO34) furnished with your truck.



UNIT IDENTIFICATION



MACK COMPONENTS

(Record Serial Numbers on the Box Provided)

VEHICLE IDENTIFICATION NUMBER (VIN)

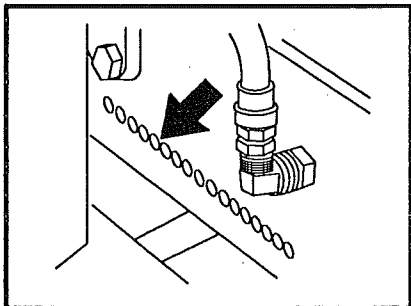

Located on the Right Hand Front Frame Rail

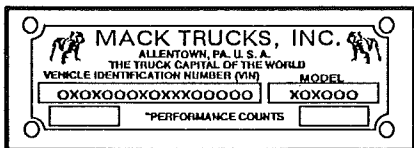

Located on a Plate Mounted on the Lower Edge of the Driver's Door Locking Edge

ENGINE STAMPING

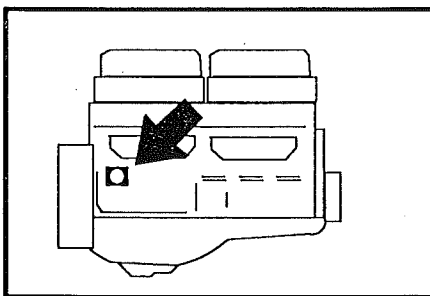

All Six Cylinders—
Located on the right side of the engine, to the rear.





UNIT IDENTIFICATION



MACK COMPONENTS

(Record Serial Numbers on the Box Provided)

TRANSMISSION

T200 Series—Located on the Left Side of the Main Case Near the Rear

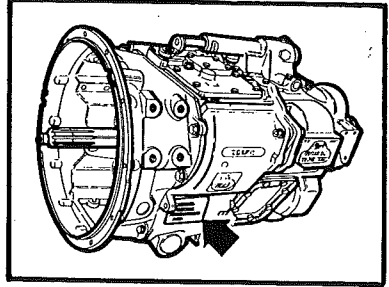

T107 SERIES—Located on the Left Side of the Main Case Near the Front

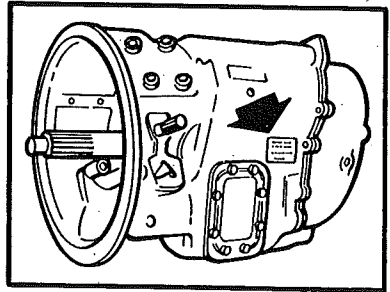

REARS

Arrangement Number—Located on the Right Side of the Rear Axle Housing

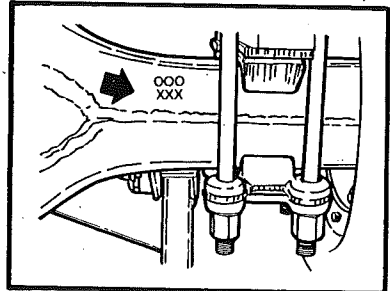

Carrier Assembly Number—Located on the Right Front of Housing

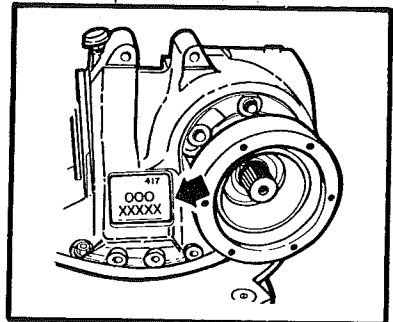



UNIT IDENTIFICATION



ENGINE INFORMATION PLATE LOCATION

(ALL E7 ENGINE MODELS)

The **Engine Information Plate** is mounted on the cylinder head cover on the above mentioned models. (See the illustration below.)

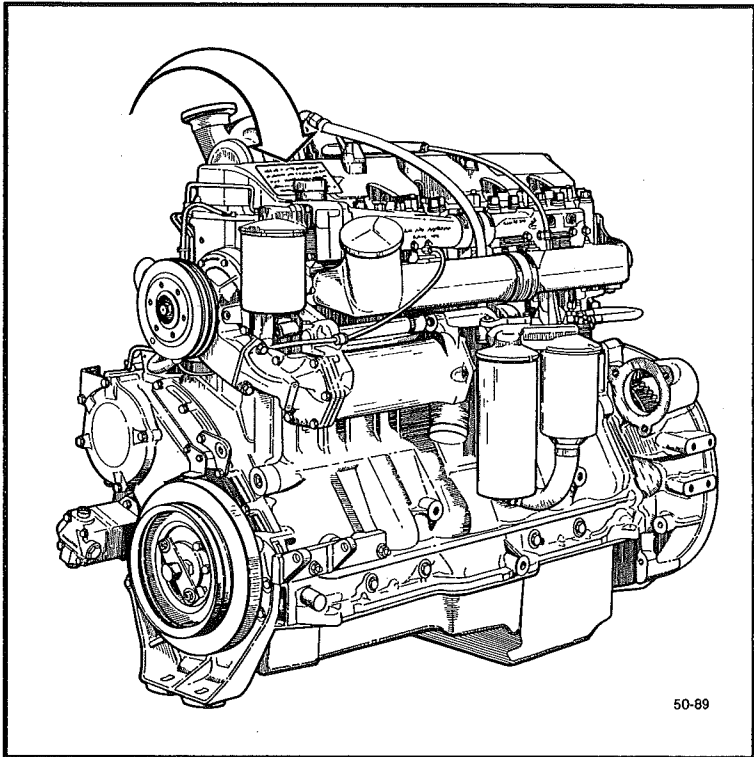



NOTES





CERTIFICATION LABELS



SAFETY CERTIFICATION LABEL

The National Highway Traffic Safety Administration (NHTSA) regulations require that a certification label be affixed to all vehicles.

The NHTSA regulations also require that the certification label be affixed to either the hinge pillar, door latch post, or the door edge that meets the door latch post, next to the driver's seat. If none of these locations are practical, it may be attached to the left side of the instrument panel, or affixed to an inward facing surface of the driver's door.

MACK COMPLETED VEHICLE

On Mack completed vehicles, this label contains the following information:

- ☞ Date of Manufacture
- ☞ Vehicle Identification Number (VIN)
- ☞ GVWR, GAWR and Tire and Rim Data

On Mack vehicles, the certification label is generally affixed to the driver's side cab door hinge pillar. If not, it will be found at one of the other NHTSA specified locations.

	GVWR _____	VEHICLE TYPE _____	DATE _____	MANUFACTURED BY MACK TRUCKS, INC.
FRONT AXLE GAWR _____	WITH _____	TIRES _____	RIMS AT _____	COLD _____ SINGLE _____
1ST INT AXLE GAWR _____	WITH _____	TIRES _____	RIMS AT _____	COLD _____
2ND INT AXLE GAWR _____	WITH _____	TIRES _____	RIMS AT _____	COLD _____
3RD INT AXLE GAWR _____	WITH _____	TIRES _____	RIMS AT _____	COLD _____
REARMOST AXLE GAWR _____	WITH _____	TIRES _____	RIMS AT _____	COLD _____
THIS VEHICLE CONFORMS TO ALL APPLICABLE FEDERAL MOTOR VEHICLE SAFETY STANDARDS IN EFFECT ON THE DATE OF MANUFACTURE SHOWN ABOVE.				
45MR3100				

42-2





CERTIFICATION LABELS



MACK INCOMPLETE VEHICLES

A chassis cab is an incomplete vehicle with completed occupant compartment, that requires the addition of cargo-carrying, work-performing of load-bearing components to perform its intended functions.

The manufacturer of a chassis-cab is required to affix a label to the incomplete vehicle in one of the previously noted locations. This label will provide the date of manufacture of the chassis-cab, the vehicle identification number and vehicle certification information.

	DATE _____	CHASSIS-CAB MANUFACTURED BY MACK TRUCKS, INC. VEHICLE IDENTIFICATION NUMBER (VIN) _____
THIS CHASSIS-CAB CONFORMS TO FEDERAL MOTOR VEHICLE SAFETY STANDARD NOS. 101, 102, 103, 104, 106, 107, 111, 113, 115, 116, 124, 205, 206, 207, 208, 209, 210, AND 302.		
THIS VEHICLE WILL CONFORM TO STANDARD NOS. 108, 120, AND 121 IF IT IS COMPLETED IN ACCORDANCE WITH THE INSTRUCTIONS CONTAINED IN THE INCOMPLETE VEHICLE DOCUMENT FURNISHED PURSUANT TO 49 CFR PART 568.		
CONFORMITY TO THE OTHER SAFETY STANDARDS APPLICABLE TO THIS VEHICLE WHEN COMPLETED IS NOT SUBSTANTIALLY AFFECTED BY THE DESIGN OF THE CHASSIS-CAB.		
		4MR3143

42-3



DOORS



The inside door handles used on the CH are of the flush mounted paddle type design.

To open, put your fingers behind the handle and pull out while exerting some force on the door to open it.

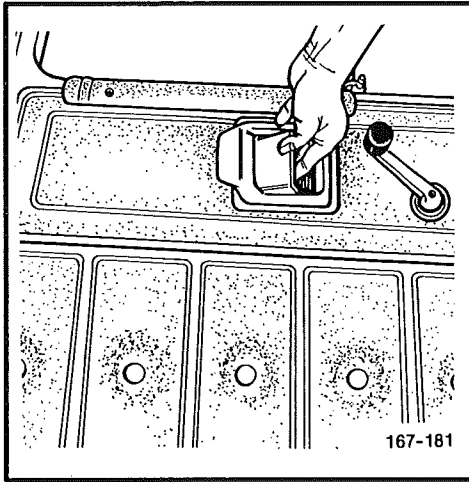

To lock, (with door closed) from the inside, press the door handle inward.

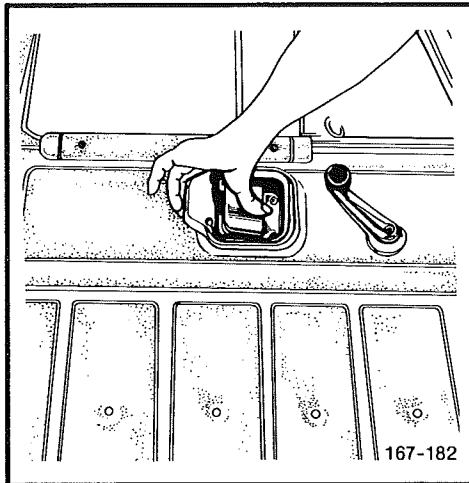



CAB ENTRY



DRIVER'S SIDE

The primary rule to follow when entering or exiting a cab is for the driver and/or passenger to have at least three limbs in contact with the vehicle at all times. This means that a minimum of two hands and a foot or a hand and two feet must be in FIRM contact with the vehicle (or ground surface) to avoid mishaps due to carelessness.

▲WARNING

GUIDELINES FOR ENTERING AND EXITING TO AVOID SERIOUS INJURY.

Face cab when entering AND exiting.

Place papers, coats, etc., in cab BEFORE entering—take out AFTER exiting—keep hands free to grip handholds.

Keep hands and shoes clean—check hands and shoes for grease, mud, etc., BEFORE entering or exiting.

Keep three limbs (two hands and a foot or a hand and two feet) in FIRM contact with steps and handholds at ALL times.

Be sure of where you step and grab—keep these areas clean.

Be EXTRA careful in rainy, snowy, etc., weather.
Do NOT jump from the vehicle.



CAB ENTRY



▲WARNING

To avoid serious injury, do NOT step on the fuel tank, battery box, frame, etc. unless adequate slip resistant surfaces and handholds are provided.

When entering and exiting the cab, be aware of the condition of the steps and handholds, especially in snow or icy weather. At such times when ice and snow may accumulate on the steps and handholds, they should be cleaned off to minimize the possibility of slipping.

The same warning applies to grease or oil which may be present on steps and handholds.

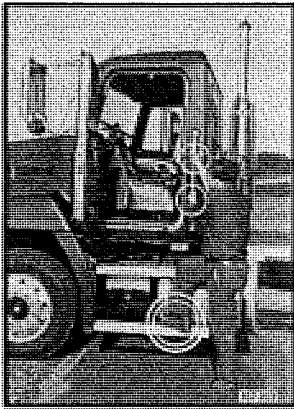

1. With two hands on the handhold, raise your right foot up to the lowest step.



2. Raise your left foot up to the second step.





CAB ENTRY

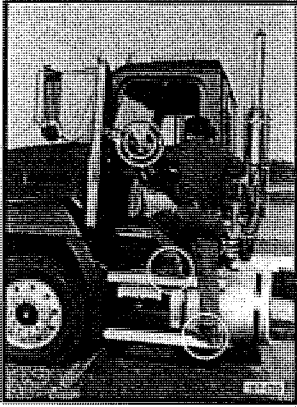

3. Reach in with your left hand and grab the steering wheel.

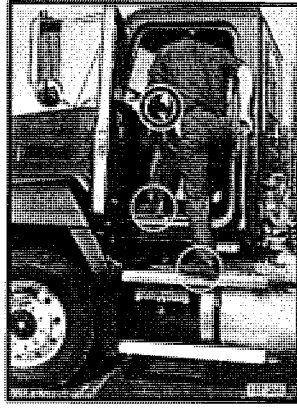

4. Raise your right foot up to the cab floor.



5. Move your body into the cab and have a seat.



CAB EXIT



DRIVER'S SIDE

The primary rule to follow when entering or exiting a cab is for the driver and/or passenger to have at least three limbs in contact with the vehicle at all times. This means that a minimum of two hands and a foot or a hand and two feet must be in FIRM contact with the vehicle (or ground surface) to avoid mishaps due to carelessness.

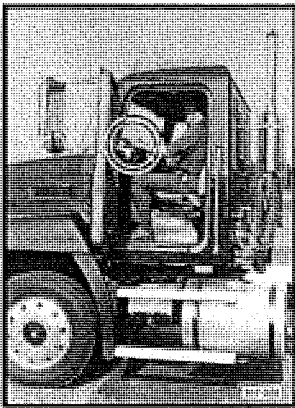

1. Open the door, then keep both hands on the steering wheel as you prepare to exit.

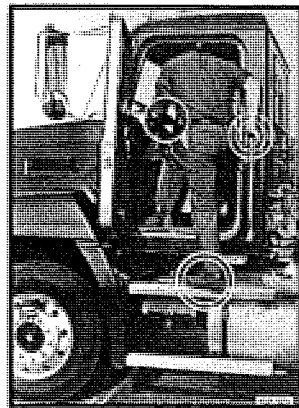

2. Move your left foot out to the top step, then move right hand to the outside handhold.





CAB EXIT



3. Move your right foot down to the lower step.



4. Move your left hand from the steering wheel to the outside handhold.

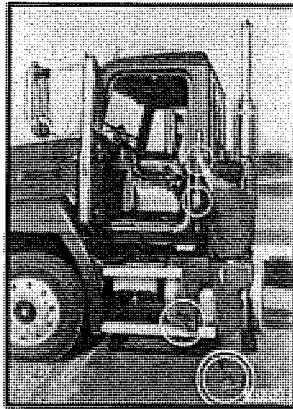

5. Move your left foot down to the ground.



PASSENGER'S SIDE

The primary rule to follow when entering or exiting a cab is for the driver and/or passenger to have at least three limbs in contact with the vehicle at all times. This means that a minimum of two hands and a foot or a hand and two feet must be in FIRM contact with the vehicle (or ground surface) to avoid mishaps due to carelessness.

WARNING

GUIDELINES FOR ENTERING AND EXITING TO AVOID SERIOUS INJURY.

Face cab when entering AND exiting.

Place papers, coats, etc., in cab BEFORE entering—take out AFTER exiting—keep hands free to grip handholds.

Keep hands and shoes clean—check hands and shoes for grease, mud, etc., BEFORE entering or exiting.

Keep three limbs (two hands and a foot or a hand and two feet) in FIRM contact with steps and handholds at ALL times.

Be sure of where you step and grab—keep these areas clean.

Be EXTRA careful in rainy, snowy, etc., weather. Do NOT jump from the vehicle.





CAB ENTRY



▲ WARNING

To avoid serious injury, do NOT step on the fuel tank, battery box, frame, etc. unless adequate slip resistant surfaces and handholds are provided.

When entering and exiting the cab, be aware of the condition of the steps and handholds, especially in snow or icy weather. At such times when ice and snow may accumulate on the steps and handholds, they should be cleaned off to minimize the possibility of slipping.

The same warning applies to grease or oil which may be present on steps and handholds.

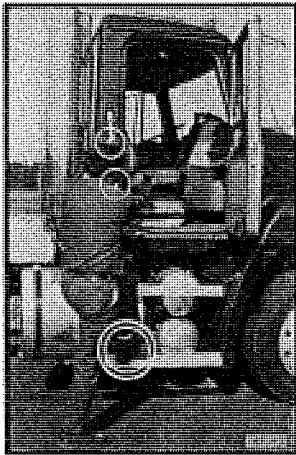

1. With both hands on the outside handhold, place your left foot on the lower step.



2. Move your right foot to the upper step.

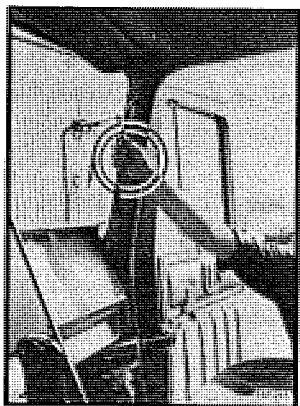

3. Move your right hand to the inner handhold (mounted on the door hinge post).

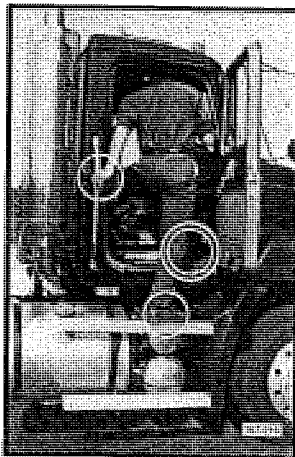

4. Move your left foot in to the cab floor.



5. Move your body into the cab and have a seat.





PASSENGER'S SIDE

The primary rule to follow when entering or exiting a cab is for the driver and/or passenger to have at least three limbs in contact with the vehicle at all times. This means that a minimum of two hands and a foot or a hand and two feet must be in FIRM contact with the vehicle (or ground surface) to avoid mishaps due to carelessness.

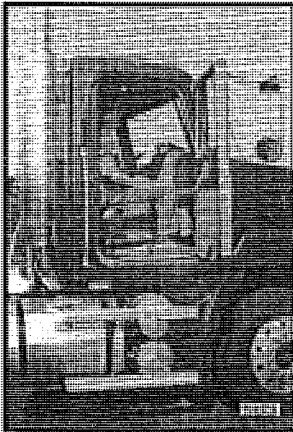

1. Open the door.

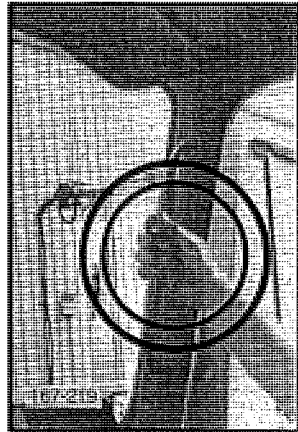

2. Place your right hand on the inside handhold (mounted on the door hinge post).



CAB EXIT

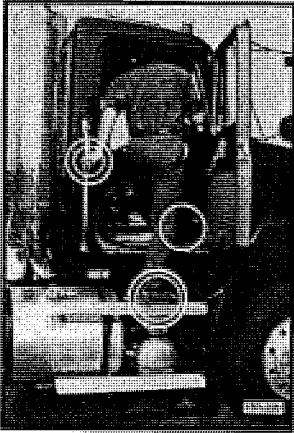

3. Move your right foot out to the upper step, then move your left hand to the outer handhold.

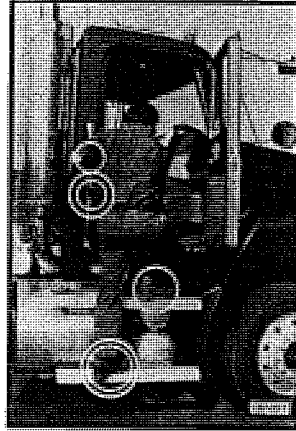

4. Move your right hand to the outside handhold, then move your left foot to the lower step.

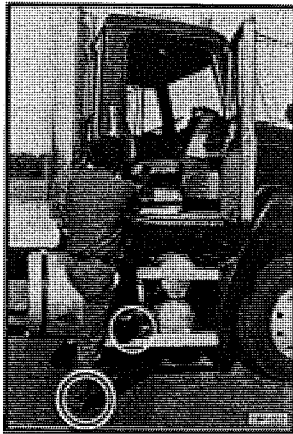

5. Move your right foot down to the ground.





SEAT BELTS



▲WARNING

Use seat belts and bunk restraints (if so equipped) to minimize the risk of serious personal injury in the event of an accident.

OPERATION

Mack vehicles manufactured on or after September 1, 1990 are required to have locking retractable seat belts. For most seating positions on your Mack vehicle, this type of seat belts is a combination lap and shoulder belt. In a few cases, the seat belt will be lap belt only. Both types of belts are designed to lock (that is, prevent belt travel out of the retractor) only during sudden stops or impacts. This feature allows the wearer to move freely under normal conditions. The combination lap and shoulder belts cannot be made to lock by jerking on the belt except during sudden stops or harsh bumps.

FASTENING BELT

1. Pull the clip so that the belt crosses your shoulder and/or lap and insert it into the buckle until an audible snap is heard.

▲WARNING

Use the shoulder belt only on the shoulder that is closest to the vehicle door. Never wear the shoulder portion of the belt under your arm or behind your back. Improper use will increase your chances of injury during a collision.



SEAT BELTS



2. Make sure the clip is securely fastened into the buckle.
3. To tighten the lap portion of the combination belt, pull upward on the shoulder portion until the lap portion fits you snugly. The belt should rest as low on your hips as possible.

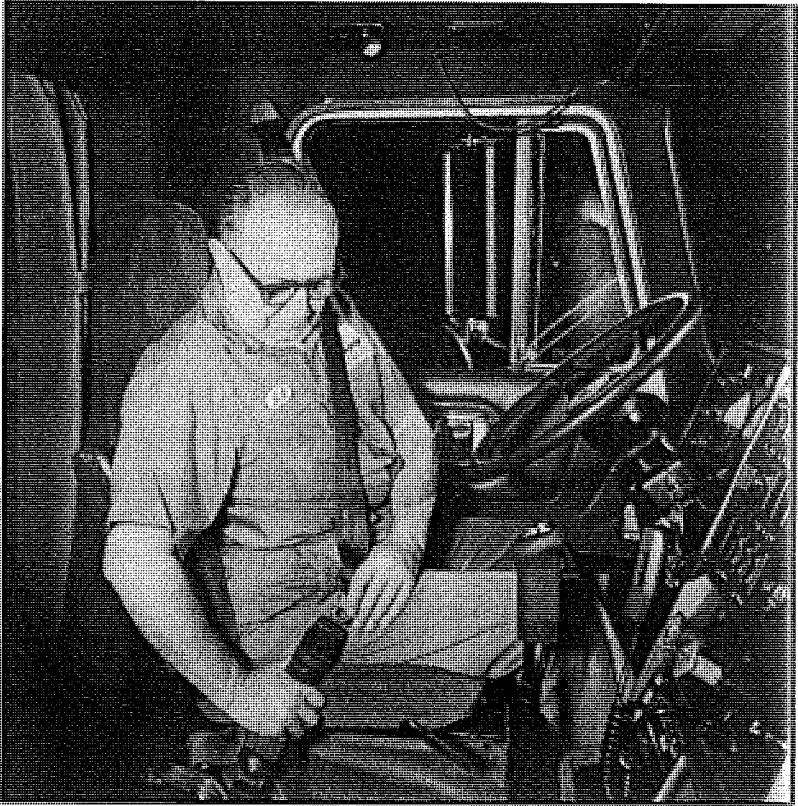



SEAT BELTS



UNFASTENING SEAT BELTS

1. Push down on the button to release the belt.

▲WARNING

Do NOT bleach or dye belt because this may cause severe loss of strength.

Do NOT use one belt for more than one person. Use of one belt for more than one person could result in injury.

MAINTENANCE

1. Keep belt clean and dry.
2. Clean with mild soap solution and luke-warm water.
3. Periodically inspect belt, retractor, and mounting points for damage or corrosion that could materially lessen effectiveness of belt installation. Replace all inadequate parts.

NOTE

Safety belt assemblies must be replaced after an accident if:

1. they have been subjected to loading by occupants even if no damage is obvious, or
2. they have been damaged by an accident (bent retractor, torn webbing, etc.)

If there is any question regarding belt or retractor condition, replace the appropriate part.



THE KOMFORT LATCH SYSTEM

TRACK III-THREE•POINT SEAT BELT ASSEMBLY

The Track III-Three Point Seat Belts installed in this chassis are designed to provide the highest degree of operator safety, comfort and convenience. Additional comfort is provided by the Komfort® Latch mechanism which is incorporated into the seat belt assembly, and may be used to relieve any discomfort that may be caused by the constant pressure of the engaged seat belts.

SEAT BELT OPERATION

To buckle the seat belt, grasp the latch portion of the buckle, bring it across your lap (from outboard to inboard) and insert it into the fixed buckle which is mounted to the floor or seat (depending on seat type). With the belt properly latched, the pelvic and upper torso restraints will be in place and automatically adjusted to provide a snug fit.

KOMFORT® LATCH FEATURE

If the constant tension of the buckled seat belt causes any discomfort, engage the Komfort latch as follows:

WARNING

DO NOT attempt to engage the Komfort Latch feature while the truck is in motion.

1. **Engagement**—Pull the webbing of the shoulder belt away from the upper torso, pulling only as much slack as needed while still allowing the belt to exert slight pressure against your chest and shoulder. (Maximum amount of slack should not exceed 1 inch when measured from the chest to the belt.) While holding the slack, lift the lever, located on top of the Komfort latch mechanism, upward to clamp the webbing in place.





SEAT BELTS



2. **Normal Release-To** unfasten the seat belt, simply release the buckle and give the shoulder belt a quick tug to release the Komfort latch mechanism. Allow the belt to retract into the retractor.
3. **Emergency Release-**In the event of an emergency, release the seat belt buckle. It is not necessary to release the Komfort Latch in an emergency situation.

NOTE

If forward movement is required while the Komfort latch mechanism is latched, the latch automatically releases when you lean against the shoulder portion of the belt. Repeat the above steps to reset the Komfort Latch, if desired, after forward movement is no longer required.

DANGER

Excessive slack will reduce effectiveness of seat belt which could result in personal injury and death. CAREFULLY follow the instructions for adjusting the "tension - relieving" device.



NOTES





A Tell-Tale, by definition, is a display that indicates, by means of a light-emitting signal, the actuation of a device, a correct or defective functioning or condition, or a failure to function.

The operator should become familiar with these symbols to enable him to recognize and react, if necessary, to the indicated condition.

COLORS

To promote visual recognition internationally, specific colors for tell-tales have been established. Unless governmental regulations, where the vehicle is to be used, or Engineering directives specify otherwise, the standard colors shall be:

Blue—High beam headlights.

Flashing Green—Turn signals.

Flashing Red—Hazard condition involving the safety of personnel.

Steady Green—System in operation.

Steady Red—Warning, immediate action required.

Amber—Early warning, such as low fuel or anti-lock malfunction.

Tell-tale symbols are shown next to the callout and description of the instruments and controls on the following pages.



INSTRUMENT PANEL



INSTRUMENT PANEL ARRANGEMENT

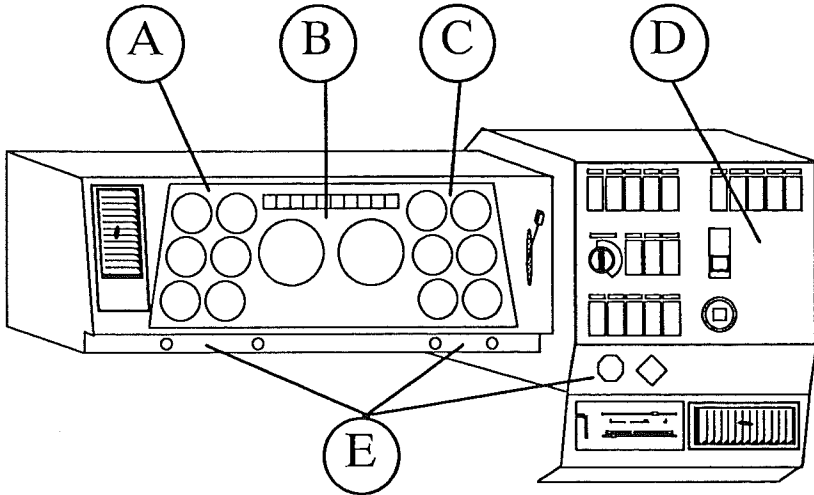

Your view from the driver's seat will look something like this. The layout has been designed to provide the operator a good view of the gages and controls (which are placed so they are within easy reach). The instrument panel as shown in the above line drawing, is broken down into five main sections. For easy identification, we will refer to them, from left to right as Panels A, B, C, D and E.





INSTRUMENT PANEL



PANEL A

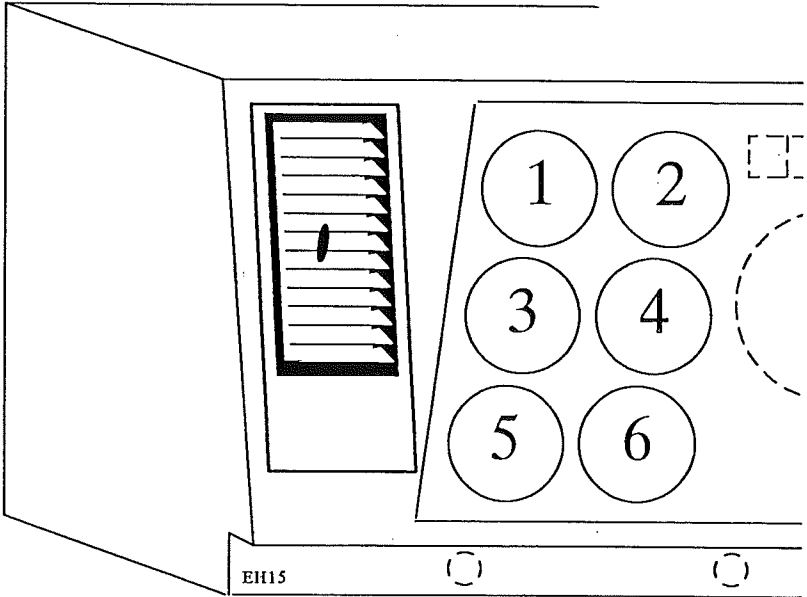

① **Manifold Pressure Gage**—measures the (charge air) boost pressure in the intake manifold.



② **Coolant Temperature Gage**—The normal operating range of a Mack engine as indicated by the coolant, is between 170°F. and 225°F. (77°C. to 107°C.).

Consult other manufacturers engine manuals if your vehicle is so equipped.

▲ CAUTION

Coolant temperature must NOT exceed 225°F. (107°C.).



INSTRUMENT PANEL



- ③ **Voltmeter**—This gage indicates the surface charge of the battery with the ignition switch on and the engine not running. With engine running, gage indicates condition of charging system.

The voltmeter will provide useful information. When the reading is observed during cranking, the reading normally should not drop below 10 volts. Lower readings indicate corroded connections at the cranking motor or at the battery terminals or defective or discharged batteries.



- ④ **Oil Pressure Gage**—Under normal operating conditions, the engine oil pressure will be between 40 and 95 psi (276 to 665 kPa) at governed speed on a Mack 6 cylinder depending on engine type, speed and oil viscosity.

Oil pressure should be about **9–10 psi (about 69 kPa)** on **E7 engines** at idling speed.

Should pressure at operating speeds drop suddenly from normal reading, stop engine immediately and determine cause. Other manufacturer's engines may have different requirements and specs. Consult the appropriate manufacturer's engine manuals for their respective pressures.





INSTRUMENT PANEL

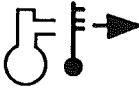

- ⑤ **Exhaust Pyrometer**—Indicates temperature of exhaust gases about 12" to 16" from the turbocharger exhaust connections. This helps the operator to select the proper gear for load and grade conditions, thereby avoiding excessive exhaust temperatures. The maximum operating temperature is shown on the nameplate of the pyrometer glass.

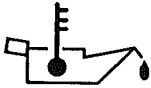

- ⑥ **Engine Oil Temperature Gage**—Indicates the temperature of the engine oil.

▲ CAUTION

Maximum safe oil temperature is 235°F. (113°C.). Continued operation with oil above this temperature will cause rapid deterioration of the oil's lubricating properties and is **NOT RECOMMENDED**.

PANEL B

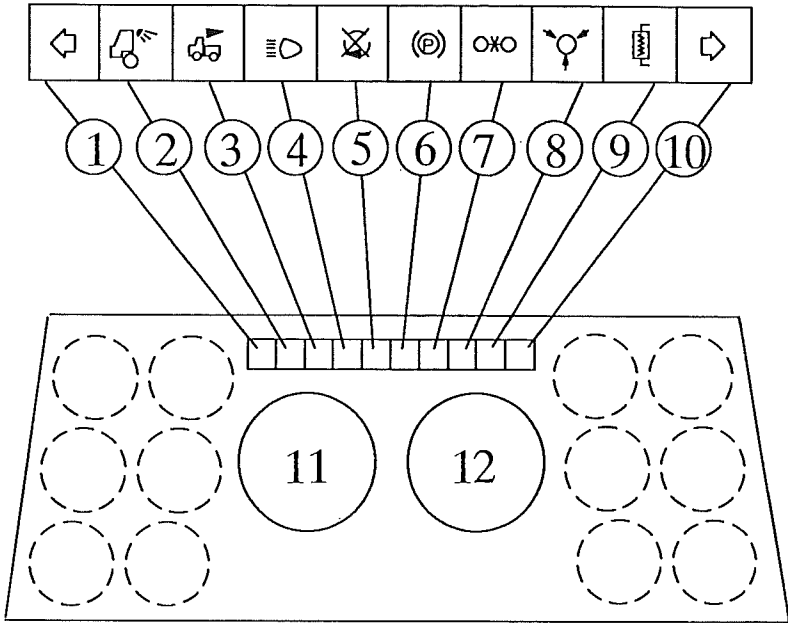

EH16

Panel B contains a ten section bank of tell-tales. When certain functions or switches are activated, the indicator lamp will light up to show it is operative. The lamp will remain lit until the function is discontinued.



- ① **Left Turn Signal Indicator Lamp**—Flashes green when the turn signal is activated.



- ② **Hook-Up Indicator Lamp (Amber).**



- ③ **Reverse Indicator Lamp (Amber).**





INSTRUMENT PANEL



④ High Beam Indicator Lamp (Blue).



⑤ Engine Shutdown Indicator Lamp (Red).



⑥ Parking Brake Indicator Lamp (Red).



⑦ Power Divider Lockout Indicator Lamp (Amber).



⑧ Air Brake Engagement Indicator Lamp (Red).



⑨ Mirror Defrost Indicator Lamp (Amber).

V-MAC

⑨ On V-MAC Equipped Vehicles, the Electronic Malfunction Tell-Tale will be located here.



⑩ Right Turn Signal Indicator Lamp—Flashes green when turn signal is activated.

⑪ Tachometer—Engine speed is indicated in revolutions per minute. The tachometer readings should be used as a guide for shifting and to prevent engine damage due to over-speed.

⑫ Speedometer and Odometer—Indicates road speed in miles and/or kilometres per hour and total distance vehicle has traveled.



INSTRUMENT PANEL



PANEL C

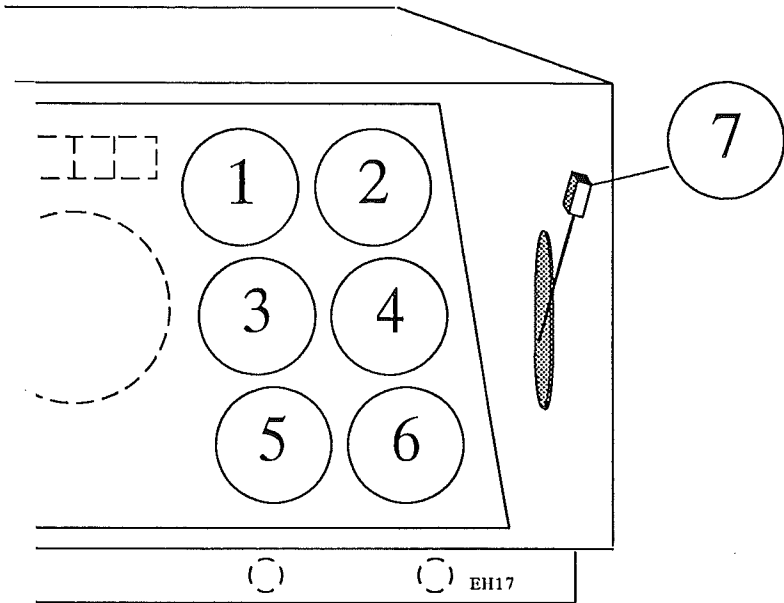

① and ③ Air Pressure Gage—Normal operating air pressure is between 90 psi (620 kPa) and 125 psi (827 kPa) in both air brake systems. If pressure drops below 75 (± 5 psi) in either system, the warning buzzer and warning lamp will operate. Determine the cause of failure before proceeding. Primary air pressure is supplied to the rear brakes and is indicated by the green pointer on the gage. Secondary air pressure is supplied to the steering axle brakes and indicated by the orange pointer.





INSTRUMENT PANEL



- ② Air Application Gage—Measures the air pressure being delivered to the service brake chambers in the tractor (and trailer if attached).



- ④ Fuel Gage—Registers fuel level in supply tank(s).



- ⑤ Oil Temperature Gage (Mack Rear Axle)—Shows the oil temperature.

▲ CAUTION

Maximum safe oil temperature is 235°F. (113°C.). Continued operation with oil above this temperature will cause rapid deterioration of the oil's lubricating properties and is NOT RECOMMENDED.

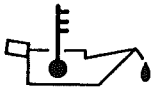

- ⑥ Oil Temperature Gage (Mack Transmission)—Shows the oil temperature.

▲ CAUTION

Maximum safe oil temperature is 235°F. (113°C.). Continued operation with oil above this temperature will cause rapid deterioration of the oil's lubricating properties and is NOT RECOMMENDED.

- ⑦ Trailer Brake Lever—Pull down to activate the trailer brakes.

▲ WARNING

The trailer braking system must NOT be used for parking.



INSTRUMENT PANEL



PANEL D

This panel is devoted to lighting and some optional items. Your particular chassis may not include some items shown.

For a more detailed description of certain items on this panel which are directly related to the V-MAC system, see the V-MAC Operator's Guide, TS725.

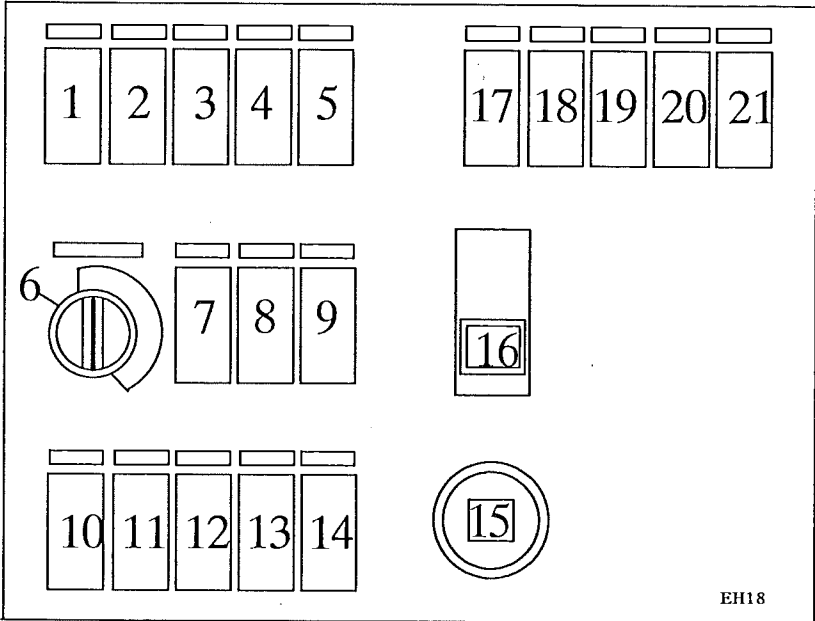

① **Light Switch**—This is a three position switch allowing the operator to choose between parking lights (push bottom in), headlights (push top in), or OFF (middle position).



② **Clearance Lamp Switch**—This is a two position switch. Push the top to activate the clearance lights on the tractor and the trailer. Push the bottom to turn the switch OFF.





INSTRUMENT PANEL



- ③ **Fog Lamp Switch**—This is a two position rocker switch. Push the top to activate the fog lights and push the bottom to turn them OFF.



- ④ **Hook Up Lamp Switch**—This is a two position rocker switch. Push the top to activate the lights and push the bottom to turn it OFF.



- ⑤ **Mirror Defroster Switch**—This is a two position rocker switch. Push the top in activates outside rear view mirror defrosters. Push the bottom in turns mirror defrosters off.

- ⑥ **Windshield Wiper/ Washer Control**—Push knob in to activate the washers. Twelve o'clock position is OFF. The area between OFF and LOW is intermittent wiper control. Four o'clock position is LOW speed. Five o'clock position is HIGH speed.



- ⑦ **Engine Brake Switch** (if applicable)

- ⑧ **Cold Start Switch**—Press at the top to activate the solenoid for the cold start system.



- ⑨ **Override Button**—Allows the operator to temporarily override the engine shutdown system by pushing the button. This is to be used for the purpose of moving the vehicle to safety.

VARIABLE SPEED CONTROL—IF SO EQUIPPED

V-MAC

- ⑩ **Accelerator/Decelerator Set Switch (found only on vehicles with V-MAC)**—This is a spring-loaded rocker switch allows the operator to raise (press the top) or lower (press the bottom) the engine speed. The speed control switch (Item 11) must be on to use this switch.

V-MAC

- ⑪ **Speed Control Switch (found only on vehicles with V-MAC)**— This is an ON-OFF switch which must be in the ON (press top) position to use the Accelerator/Decelerator Switch shown as item 10.

Because **variable speed control** requires the function of both items 10 and 11, here is the procedure for both setting and disengaging the **variable speed control**.

SETTING SPEED CONTROL

1. The clutch must be engaged.
2. Move the speed control switch to the ON position.
3. Increase the engine speed using the accelerator pedal.
4. At the desired speed, press and release the SET switch. This setting will be maintained.





NOTE

To increase the engine speed, press and hold the accelerator set switch until the desired speed is attained, OR, press the accelerator pedal until the desired speed is attained and then press and release the set switch.

DISENGAGING THE SPEED CONTROL

NOTE

If the speed control ON/OFF switch is used to disengage the Variable Speed Control, a new speed must be set. The RESUME switch will work only if the Variable Speed Control was disengaged by using the clutch service brake.

1. To turn off the speed control system, move the speed control switch to the OFF position.
2. To momentarily disengage the speed control system, disengage the clutch, OR, apply the service brakes. This will allow you to resume at your previous speed.

NOTE

On vehicles equipped with both Single and Variable Speed Control, when the PTO is engaged, the Single Speed Control will take precedence over the Variable Speed Control.

NOTE

To reactivate the Variable Speed Control to the previously set speed, press and release the RESUME switch.



INSTRUMENT PANEL



⑫ **Power Window Switch (Driver's Side)**—Press bottom to lower the window. Press the top of the switch to raise the window.

⑬ **Power Window Switch (Passenger's Side)**—Press bottom to lower the window. Press the top of the switch to raise the window.

⑭ **Passenger's Side Power Door Lock**—Press the bottom of the switch to lock the door. Press the top to unlock the door.

⑮ **Air Filter Restriction Indicator**—Indicator shows when the element needs servicing or replacement. When the red flag locks into position, service as soon as possible to prevent engine damage. Then reset the indicator after the filter change. Check the air filter indicator daily.

⑯ **Power Take Off Neutral Switch**

⑰ **Power Take Off Switch**

⑱ **Power Divider Switch**—See the section on Inter-Axle Power Divider Control.





INSTRUMENT PANEL



①9 **Fifth Wheel Slide Switch**—Locks and releases sliding fifth wheel by air pressure. This allows the fifth wheel to be properly positioned.

②0 **Spare**

②1 **Inside/Outside Air Switch**—This switch activates a solenoid which allows you to choose between outside air or "under the hood" air to be fed to the air cleaner.



INTER-AXLE POWER DIVIDER



A driver controlled, air shifted lockout is available by which the Mack Power Divider may be rendered inoperative for short periods and then unlocked when the poor traction situation is past. When the Mack sliding clutch lockout is engaged with mating teeth of the outer cam, both axles are locked together in positive through-drive for maximum traction with no differential action taking place between axles.

Normally, the driver controlled inter-axle power divider lockout control switch is in the OUT or unlocked position. On rare occasions, it is necessary to provide positive through-drive to both bogie axles for poor traction situations.

▲ CAUTION

Stop the vehicle before actuating the air shift control valve.

NOTE

The lockout should *NOT* be used on dry, hard surfaces.

Then declutch the engine, move lockout switch to the engaged position. Re-engage clutch and drive through the slippery area.

NOTE

An electric buzzer in the cab sounds continuously as long as the lockout is engaged. This is done to remind the driver to release the lock as soon as normal traction is regained.

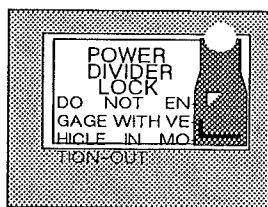

LOCKOUT DISENGAGED

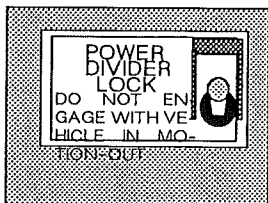

LOCKOUT ENGAGED

EH10





INTER-AXLE POWER DIVIDER



When driving conditions permit returning to normally unlocked power divider drive, move the lockout switch back to the OUT or normally disengaged position and let up momentarily on the accelerator pedal so the powershift out of locked position can be completed. Then drive as usual.

CAUTION

To avoid clash at the lockout sliding clutch and outer cam, under NO circumstances should the air shift mechanism be activated while the drive wheels are actually slipping or spinning.

NOTE

Your vehicle may or may not have an Inter-Axle Power Divider. This section has been included just in case it does.



INSTRUMENT PANEL



PANEL E

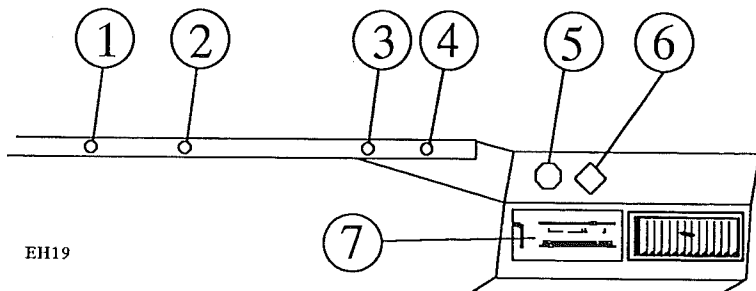

EH19



- ① Throttle (This manually operated throttle will not be included on V-MAC equipped vehicles.)—Pull out to increase idling speed. Turn clockwise to lock in position.

V-MAC

On vehicles equipped with V-MAC, refer to the TS725 for information on setting the idle speed.

▲WARNING

The throttle was designed to allow the operator to increase the idle speed of the engine. Uses other than what the throttle was designed for, are strictly prohibited. Misuse may cause damage to equipment or even fatal injuries.

- ② Panel Lights Rheostat—Rotation clockwise decreases dash light intensity.

NOTE

Panel lights will not go on unless light switch is on.





INSTRUMENT PANEL



③ **Engine Stop Control**—Pull out to stop engine (this does not apply to V-MAC equipped vehicles).



④ **Push Button Starter (option).**

⑤ **Trailer Air Supply Valve**—THIS VALVE IS NOT TO BE USED FOR PARKING. Pull to apply trailer emergency brakes. Push to pressurize trailer air reservoir releasing the trailer emergency brakes.

⑥ **Parking (Tractor Trailer) Brake Valve**—Pull to apply. Push to release.

⑦ **Heater and Air Conditioner Control Panel**—See section on Heater and Air Conditioner.



HEATER AND AIR CONDITIONER

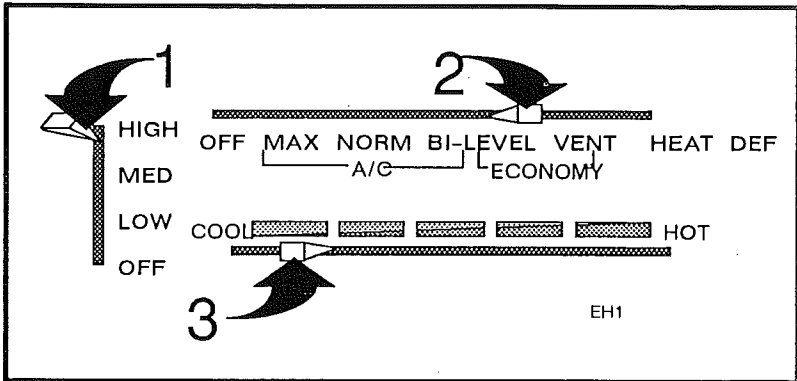

① **Fan Control Switch**—This is a four position switch to control the amount of air delivered through the vents. Down is OFF and up is HIGH speed. The middle positions are LOW and MEDIUM speeds.

② **Mode Selection Lever**—This lever lets you choose what type of climate and air direction you want in the cab.

Trucks without air conditioner—This lever provides for OFF, VENT (untreated outside air), HEAT and DEF (useful for removing condensation from the windows—eliminates inside wiping).





HEATER AND A/C



Trucks with air conditioner—This lever provides for OFF, MAX A/C (recirculates and treats cab air for the fastest cool down), NORM A/C (brings in and treats fresh air from the outside), BI-LEVEL A/C (treated cab air delivered through all dash and floor outlets), VENT (untreated outside air), HEAT and DEF (useful for removing condensation from the windows—eliminates inside wiping).

③ **Temperature Control Lever**—This sliding lever controls the temperature of air from cool (far left) to warm (far right).

NOTE

If your vehicle is equipped with air conditioning, the air conditioner unit should be run for five minutes at least once a week throughout the year to keep the moving parts well lubricated.



STEERING COLUMN



TURN SIGNAL STICK

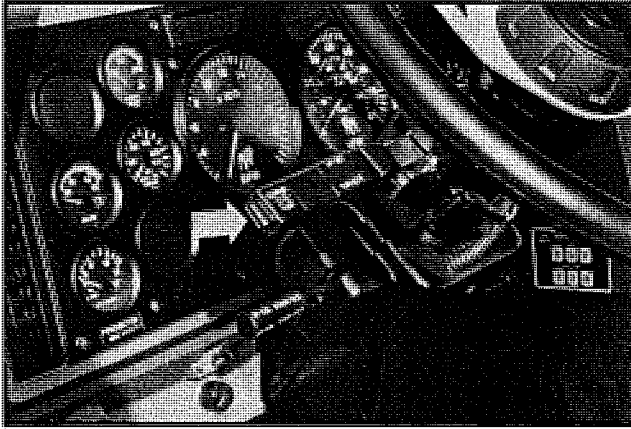

The turn signal stick is located on the steering column. It performs a number of functions including activating the high and low beams, signal switch and the hazard switch. The signal switch can be used for courtesy flashing of marker lights and for the flashing of high beams.

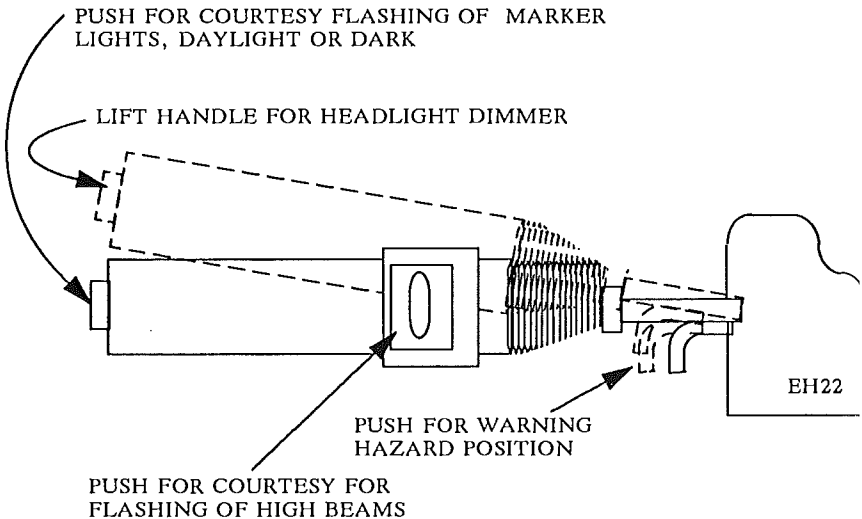

SIDE VIEW





STEERING COLUMN



NOTE

The turn signals are not self canceling and must be returned to the middle position manually.

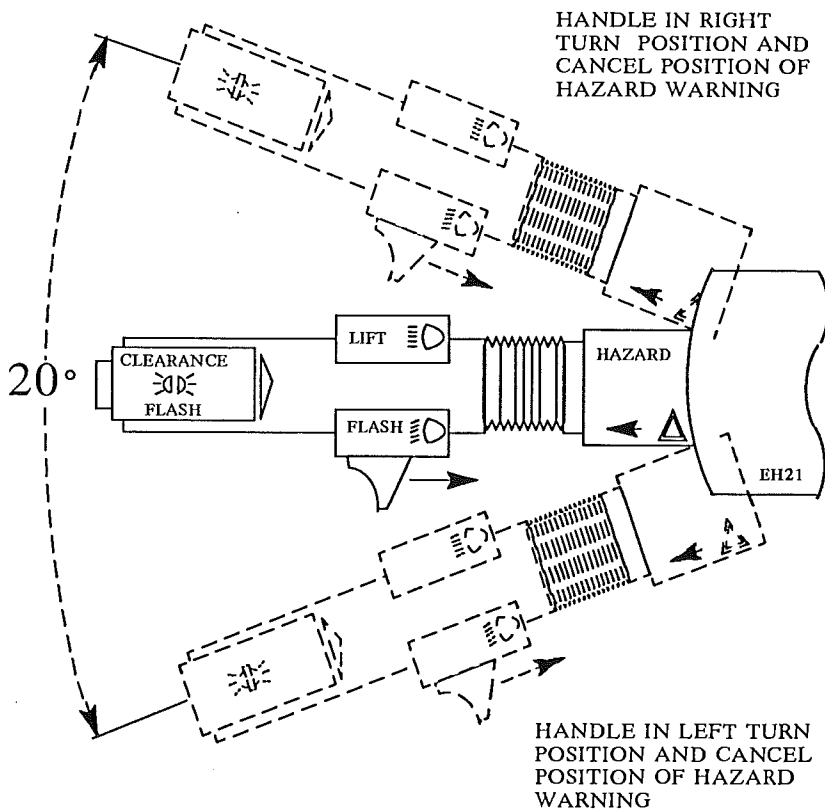

TOP VIEW



COMBINATION STARTER AND ELECTRIC SWITCH

When key is straight up and down, switch is OFF. Turn counterclockwise to activate accessories. To start engine, turn key clockwise. As soon as engine starts, release the key which will automatically return to running position. When switch is turned to on in either direction, a warning buzzer will sound if air pressure is below 65 ± 5 psi (448 ± 34 kPa). Buzzer shuts off as soon as sufficient air pressure is restored.

V-MAC

For information on the engine protection/shut-down system as it relates to V-MAC, consult the TS725.

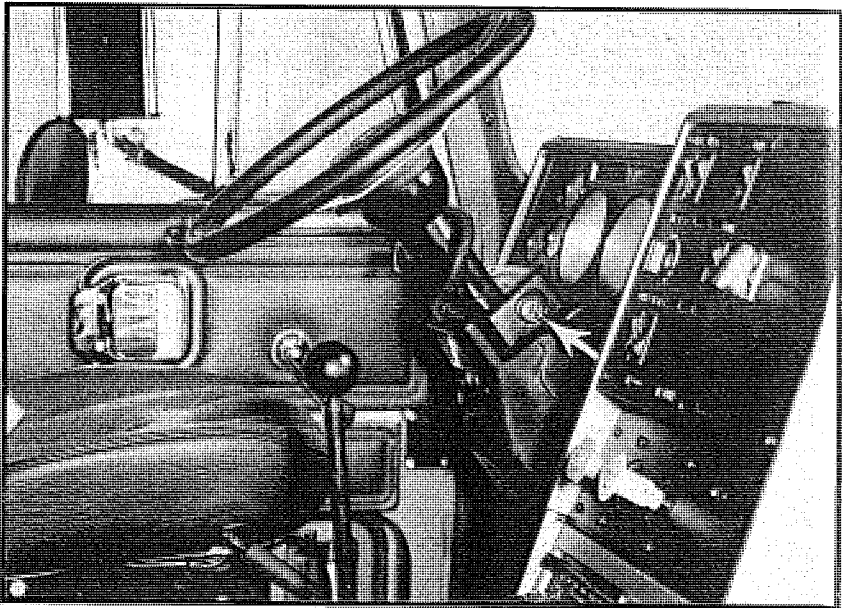



STEERING COLUMN



STEERING WHEEL ADJUSTMENT

▲WARNING

Adjust the steering wheel position **BEFORE** attempting to move the vehicle to avoid losing control of the vehicle.

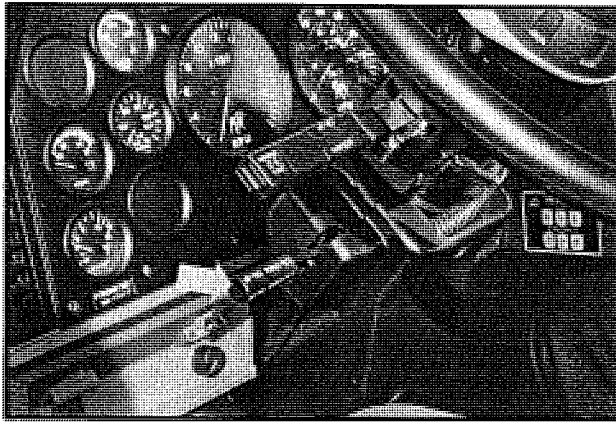

The steering column adjusts by telescoping and tilting. There is a lever which controls these functions (see the illustration above).

TELESCOPING

Pull up on the lever and the steering column will telescope in any one of five different positions.

TILTING

Push down on the lever to tilt the steering column to any one of five different positions.



CIRCUIT BREAKERS

The circuit breakers in the CH models are located behind a panel which is situated in front of the passenger's seat.

The access panel is removed by two easily operated tabs, or by removing the four torx head screws, depending upon the interior trim level specified.

▲ CAUTION

For proper installation of electrical accessories, all wiring should be routed through the junction block with Type II circuit breakers.

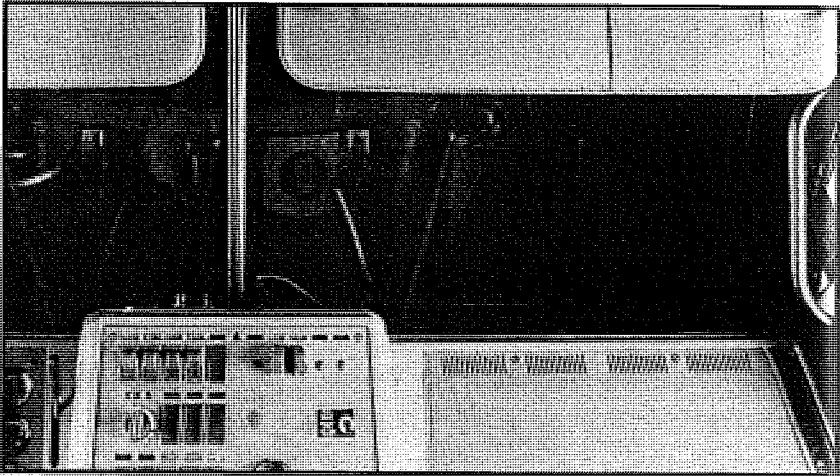



ELECTRICAL

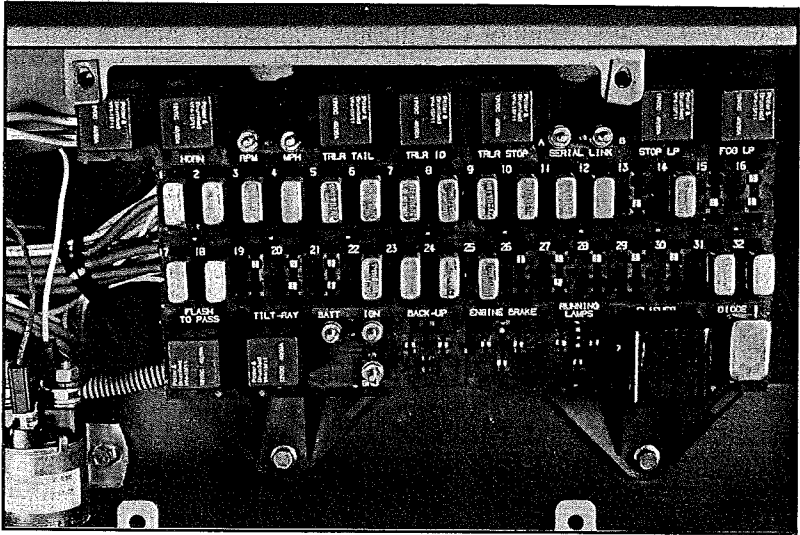

The headlamp circuit breakers are circuit breakers used in the electrical system to automatically interrupt the flow of electrical current in the event of an overload. They are SAE Type I.

SAE Type II (automatic reset non-cycling) provides a complete circuit disconnect until the overload is corrected. The power to the affected circuit breaker must be shut off before the circuit breaker will reset itself.

Type II's will be used in all accessory circuits except the headlight circuit. The headlights will be on Type I, cycling type circuit breakers.

The circuit breaker panel also provides access to a "battery," "ignition" and a "ground" terminal for non-factory installed electronic equipment. Also provided are two serial link terminals for easy local connection of a trip recording device.



HOOD



To open the hood of a CH, release the rubber hold-down straps on each side of the hood.

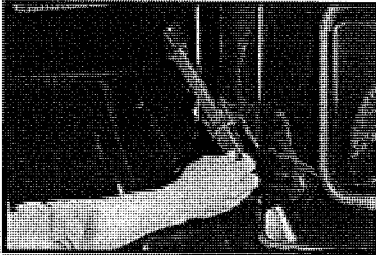

1. With the hood in locked position, pull outward on the metal tab...

...force the tab back toward the rubber strap so the locking discs can be removed from the hood latch.

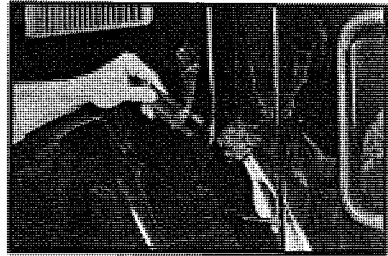

2. Swing the rubber strap up and out of the way.

Repeat this procedure on the other side of the hood.

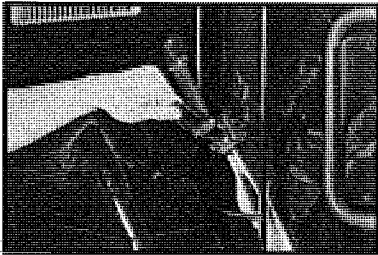

▲WARNING

NEVER take both feet off the ground to tilt the hood. Keep at least one foot on the ground to avoid a slip or fall. Use a helper or assistant whenever possible.





HOOD



3. Using the Bulldog as a handle, pull on the hood to raise it over the engine. You may use one foot on the bumper if necessary.



4. Pull steadily on the hood until it comes over center and stops fully open.



HOOD

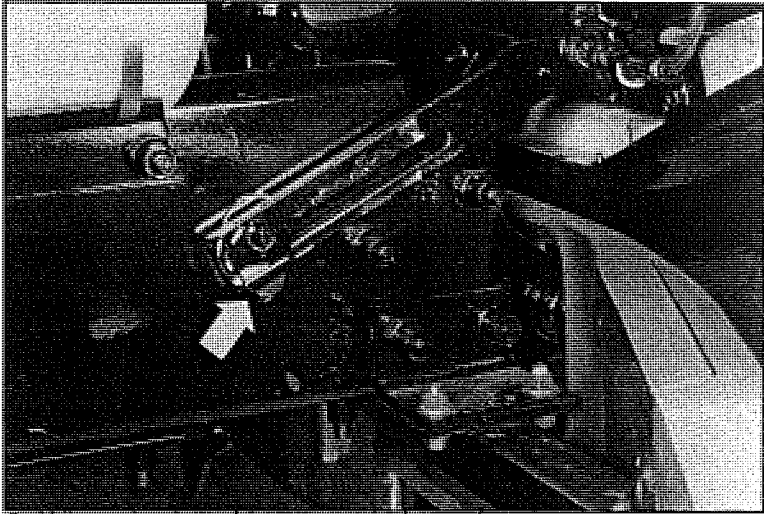

5. When the hood is opened, the safety latch drops down into a locked position.

⚠ CAUTION

Avoid hood damage. Release the hood prop before closing the hood.

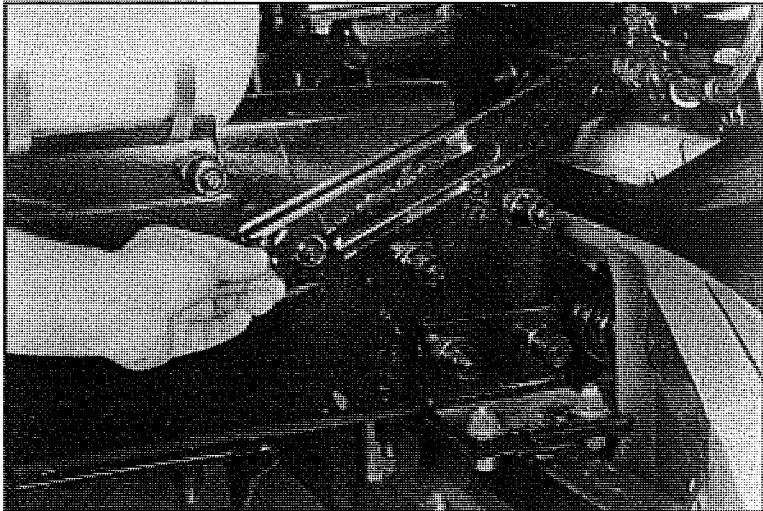

6. Before closing the hood, the safety latch must be released (reset) before the hood will close.





HOOD



To lock the hood of a CH, secure the rubber hold-down straps on each side of the hood.

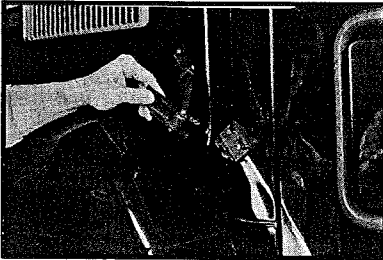

1. With the hood in down, set the rubber strap in position.....

.....force the locking discs under the hood latch.

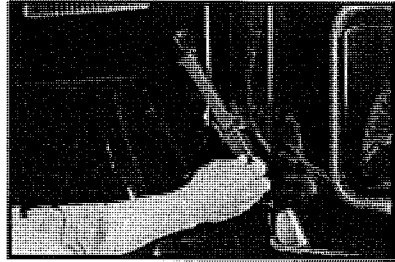

2. Push in on the metal tabs to lock the rubber strap in place

Repeat this procedure on the other side of the hood.





NOTES





OPERATION



GETTING THE MOST FROM YOUR MACK CH®



CH

CH OPERATOR'S HANDBOOK



NOTES





A GUIDE TO SAFE, ECONOMICAL OPERATION

Don't overload your truck! The gross vehicle weight ratings for a given model truck vary with operating conditions, tire size, wheel base, frame length and overhang. For economy and safety, it is therefore important to observe the "GVW" ratings for your particular truck. This information can be found on your Vehicle Certification Label.

OBSERVE INSTRUMENTS

Glance at instruments frequently. When problems develop, take prompt steps to correct them.

STOPPING ENGINE

After a hard run, allow engine to idle three minutes before shutdown in order to stabilize the temperature of all engine parts. Quick shutdowns can cause engine damage and prevent the turbocharger from being properly lubricated.

PARKING

Use only the parking brake for parking. **DO NOT USE TRAILER BRAKE LEVER FOR PARKING.** Check frequently to be certain brakes are adjusted to lock and hold vehicle when parked. Do **NOT** use the parking brake for braking vehicle when in motion except in an emergency. When parking on a grade, use wheel chocks under the rear wheels or turn front wheels to the curb. Do **NOT** leave diesel engine vehicles in gear; if vehicle should move, the engine may start by heat of compression. Be sure the engine stop knob is left in the **OUT** (engine stopped) position to prevent accidental starting.

GENERAL OBSERVATION

Make it a habit, at stops to walk around your truck to look for fuel, oil and coolant leaks and condition of tires, wheel nuts, springs and lights. Stop trouble before it stops you.



BREAK-IN



BREAK IN

NOTE

It is important that components be filled with lubricants meeting the specifications as given in the Lubricants and Capacities section found in the Maintenance and Lubrication Manual, TS494.

Your new Mack truck has been thoroughly inspected, adjusted and lubricated by your Mack service center. As moving parts "wear in" or as gaskets "take a set," an occasional oil, air or coolant leak may develop. Prompt action to correct these minor mechanical items will prevent a major repair later. Refer to the following "break in" recommendations and take the truck to the nearest Mack service center as soon as any abnormal condition becomes evident.

DURING THE FIRST 3,000 MILES/5 000 KILOMETRES,

- Check the oil and coolant levels frequently.

- Check brake and clutch adjustments frequently and adjust as needed.

- Observe your dashboard instruments often and shut down the vehicle at the first sign of any abnormal readings.

- Report all leaks, loose fasteners, unusual noises, etc., to the service representative at your nearest branch or distributor, so they may be checked and corrected as soon as possible.

- Check spring clip torque (U-bolts). (On Reyco Suspensions, also check equalizer nut torque).

- Check the U-bolt torque on the Mack Air Suspension at the end of the first 1000 miles (1 600) kilometres of service.





NOTE

All checks and adjustments referred to in this vehicle break-in section can be found in the Maintenance and Lubrication Manual, TS494.

AT THE END OF THE FIRST 3,000 MILES/5 000 KILOMETRES OR BEFORE 4,000 MILES/6 400 KILOMETRES OR 3 TO 4 MONTHS

-Change the engine lubricating oil, oil filters, fuel filters and coolant conditioner.

-Change the geared units' (transmission, auxiliary transmission, transfer case, power take-off, front driving axle, rear driving axle[s]) lubricating oils.

-Lubricate the chassis.

-Retorque spring clips (U-bolts). (On Reyco Suspension, retorque spring clips and equalizer nuts).

OIL CHECK

As the operator of this vehicle, it is important for you to perform the daily inspections necessary to keep your truck in top shape. Maintaining the proper level in your engine crankcase cannot be overemphasized.

Before checking the oil, remember these important points.

-Measurement of the oil level must be taken on level ground.

-If the engine has been running, allow about fifteen minutes after shutdown for oil to drain down to the oil pan.

-The level must be close to the full line (the top of the cross hatch pattern) on the dipstick, but must NOT exceed that line.



DAILY INSPECTION



This section has been written with two things in mind, the truck and its operator. The goal of this section is to get the truck and the operator to function as one unit. The truck has been designed to work hard and give the you years of efficiency and performance with the proper care. It's the operator's job to provide the proper care, through maintenance and lubrication (see the TS494). Good operating habits formed early will make you and your truck a great team.

▲ WARNING

To avoid serious injury, Do NOT step on fuel tank, battery box, frame, etc. unless adequate slip resistant surfaces and handholds are provided.

BEFORE STARTING OUT-TAKE A WALK

The driver of each shift should make a "walk around" inspection daily to check the safety equipment and levels or operation and conditions of the following:

INSIDE

- | | |
|---|---|
| <input type="checkbox"/> AIR PRESSURE AT GAGE | <input type="checkbox"/> FOOT PEDALS |
| <input type="checkbox"/> ALL INSTRUMENTS | <input type="checkbox"/> WINDSHIELD WIPERS |
| <input type="checkbox"/> ALL BRAKES | <input type="checkbox"/> WINDSHIELD WASHERS |
| <input type="checkbox"/> STEERING | <input type="checkbox"/> SIGNALING DEVICES |
| <input type="checkbox"/> HORN | <input type="checkbox"/> HEATER / DEFROSTER |
| <input type="checkbox"/> SEAT BELTS | <input type="checkbox"/> SEAT ADJUSTMENT |





DAILY INSPECTION



OUTSIDE

- FUEL IN TANK AND FUEL LINES
- OIL IN ENGINE
- COOLANT LEVEL
- PROPER AIR PRESSURE IN ALL TIRES
- DRAIN THE AIR SEPARATOR
- CHECK FOR FLUID LEAKS
- FRONT WHEEL BEARINGS (OIL)
- DOORS AND WINDOWS
- CHECK FOR BROKEN OR CRACKED LIGHTS OR LENSES
- PROPER LICENSING AND PLATES
- REAR VIEW MIRRORS PROPERLY ADJUSTED
- REFLECTORS IN PLACE AND NOT BROKEN
- WHEEL STUD NUTS TIGHT AND IN PLACE
- HOOD LATCHES SECURE
- CHECK OPERATION OF LIGHTS AND TURN SIGNALS
- CHECK HANDHOLDS, DECK PLATES, BATTERY BOX COVERS, FUEL TANK AND STRAPS SECURELY FASTENED AND FREE FROM CORROSION

CAUTION

Be sure door and hood latches are secured before attempting to move the vehicle.

Get in the habit of making this daily walk-around inspection. You'll have the satisfaction of knowing your truck is in good shape. That means less unexpected down time from a breakdown and less chance of a shakedown from highway inspections for faulty equipment.



STARTING



CRANKING IT UP

The Mack engine installed in this chassis, has been designed and built to conform to the latest Federal Emission Standards. Procedures for starting the engine in your chassis may be a little different than what you are used to.

Read through the following section. Starting instructions are included for E7 V-MAC engines, E7 non V-MAC engines and the E9 engine. Special conditions may apply when starting the vehicle in cold weather, so cold weather starting is also addressed.

Climb up and into the cab (see Cab Entry). Before you put the keys in the ignition switch, set the parking (spring) brake, disengage the clutch (if so equipped) and move the shift lever into neutral. Push the engine stop button all the way in. (Because vehicles equipped with V-MAC have no stop button, this step does not apply to them.)

COLD WEATHER STARTING

NOTE

For vehicles with V-MAC, the accelerator should be pressed to the floor when starting in cold weather.

NOTE

Before attempting to start the engine during cold weather, actuate the engine stop control rack several times to insure that the injection pump control rack is free. Condensation in the fuel could cause the control rack to freeze up after extended shutdown in cold weather.





STARTING



-**Use ether sparingly.** An ether capsule may be used to assist in starting the truck in cold weather. However, too much ether will damage the engine.

-**Save your batteries.** Do not overtax batteries and starting motor by cranking for more than thirty seconds without interruption. Allow about two minutes between attempts at starting the truck. This permits starter to cool and batteries to reenergize.

Here are a few tips that will make cold weather starting easier on you and your truck.

-**Use the correct grade of oil** in your crankcase for the prevailing winter temperature.

-**Diesel fuel has some bad habits in cold weather.** It can gel and clog filters and small passages. In those circumstances where gelling occurs, it is permissible to mix a small percentage of number one fuel (kerosene) to your number two (diesel) fuel. The addition of kerosene is NOT recommended for general use since there will be a sacrifice in both performance and fuel economy.

-**Water/moisture can accumulate in the fuel system.** This can be avoided by regularly draining the tanks and filters. Water accumulation can freeze in fuel tank, fuel lines and filter. To prevent fuel freeze-up, add one pint of isopropyl alcohol for every 100 gallons of diesel fuel.

WARNING

Under NO circumstances should gasoline or other liquid materials be used in place of kerosene or alcohol.



STARTING



E7 NON V-MAC ENGINES

If your chassis is equipped with a mechanically governed E7 (non V-MAC) engine, use the following procedure:

DURING COLD WEATHER

- 1 .Fully depress and hold the accelerator pedal to the floor.
- 2 .Push the Charge Air Cooler Bypass Switch to the ON position. A dash light will illuminate when the bypass is activated.

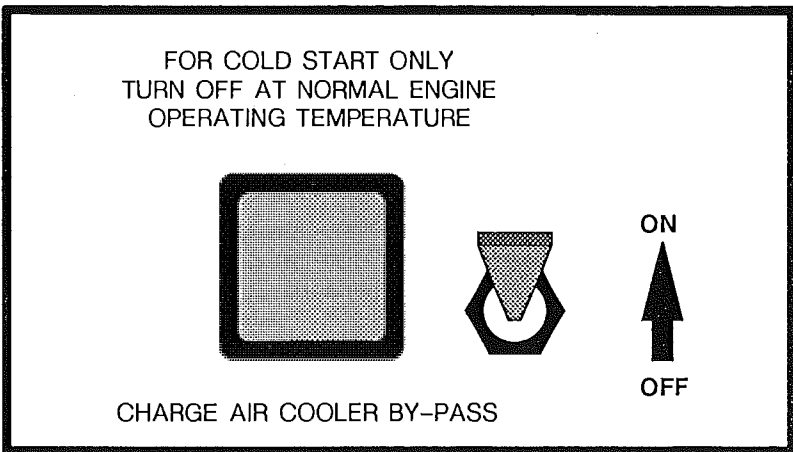

- 3 .Crank the engine.
- 4 .Release the accelerator pedal as soon as the engine starts.
- 5 .Set the hand throttle to maintain an engine speed of 1200 RPM.
- 6 .Allow the engine to idle at 1200 RPM until normal operating temperature is achieved BEFORE operating the vehicle.





STARTING



- 7 .Move the Charge Air Cooler Bypass Switch to the OFF position when the coolant temperature has reached 125 degrees F. (52 degrees C.)

▲ CAUTION

Operating the chassis with the Charge Air Cooler Bypass Switch in the ON position may cause severe engine damage.

NORMAL TEMPERATURES

- 1 .DO NOT depress the accelerator.
- 2 .Crank the engine.
- 3 .After the engine has started, set the hand throttle to maintain an engine speed of 1200 RPM.
- 4 .Allow the engine to idle at 1200 RPM until normal operating temperature is achieved BEFORE moving the vehicle.

NOTE

If difficulty is encountered when starting the engine, use the following procedure:

- 1 .With the key switch in the OFF position, fully depress and hold the accelerator pedal to the floor.
- 2 .If equipped with an Engine Stop Control, pull to the OFF position, then return to the run position.
- 3 .Crank the engine.
- 4 .Release the accelerator pedal as soon as the engine starts.



STARTING



CAUTION

DO NOT use the Charge Air Cooler Bypass switch during warm temperatures or if the engine is already warm.

NOTE

If parking (spring) brakes are not applied, hard starting may be the result.

NOTE

Do NOT rev the engine to try to achieve a faster warmup. Lubricants need time to establish a film between moving parts.

CAUTION

Engine must be warmed up to operating temperature before attempting to move the vehicle in either reverse or lo-lo range.

E7 V-MAC ENGINES

If your chassis is equipped with an electronically governed E7 (V-MAC) engine, use the following procedure:

DURING COLD WEATHER

- 1 .Fully depress and hold the accelerator pedal to the floor.
- 2 .Crank the engine.
- 3 .Release the accelerator pedal as soon as the engine starts.
- 4 .Set the Variable Speed Control (VSC) to maintain an engine speed of 1200 degrees.





STARTING



- 5 .Allow the engine to idle at 1200 RPM until normal operating temperature is achieved before attempting to move the vehicle.

NORMAL TEMPERATURES

- 1 .DO NOT depress the accelerator. The pedal must be left in the idle position.
- 2 .Crank the engine.
- 3 .After the engine has started, set the hand throttle to maintain an engine speed of 1200 RPM.
- 4 .Allow the engine to idle at 1200 RPM until normal operating temperature is achieved BEFORE moving the vehicle.

AIR STARTER OR PUSH BUTTON

Put the key in the ignition switch. Turn the key clockwise to the first "click" (about 2 o' clock position) to activate the instruments. Push starter button in and release as soon as engine starts. (If engine does not start immediately, limit cranking period to thirty seconds.) Keep clutch disengaged until engine runs smoothly. When oil pressure and air pressure approach normal operating ranges, you may put the vehicle into operation.

NOTE

Build up air pressure to a maximum (120 lbs/827kPa) before shutting down and parking for the night.

▲ CAUTION

Idling engine unnecessarily for long periods of time wastes fuel and fouls injection nozzles. Unburned fuel causes carbon formation and oil dilution. NEVER RACE AN ENGINE DURING WARMUP.



MOVING THE VEHICLE



1. To move the vehicle, begin by starting the engine and waiting until it reaches its operating range.
2. Disengage the clutch (push the pedal to the floor).
3. Shift transmission into first or low gear (see transmission section for your particular transmission and advice on how to shift and in what gear to start).
4. Release the parking brake.

CAUTION

If the spring brake warning light is on, DO NOT move the vehicle because driveline damage may result.

5. Engage clutch smoothly by releasing the clutch pedal. At the same time, apply the accelerator enough for the engine to move the load.

CAUTION

Never allow your foot to ride the clutch pedal when clutch is engaged. This will cause premature failure and short clutch facing life.

6. As vehicle gains speed, continue shifting until transmission is in highest gear possible with engine in operating range.

NOTE

Engine must be warmed up to operating temperatures before attempting to move in either reverse or lo-lo range when vehicle is equipped with a torque limiting device.





COOLING SYSTEM



The cooling system is a pressurized system. The coolant is circulated by a centrifugal pump. It is a typical system in most respects but there are a few things to keep in mind when checking or working on the cooling system.

▲WARNING

Avoid injury when checking coolant in a hot engine. Wait for the engine to cool prior to checking the level whenever possible.

Turn the radiator cap counterclockwise to the first stop but do NOT depress. After the pressure has completely dissipated, press the cap downward and continue turning to remove.

DRAINING

Whenever repairs are to be made which would require disconnecting of coolant hoses, etc., the cooling system should be completely drained. Carefully remove the filler cap and open all coolant drain cocks.

REFILLING

Close all drain cocks and fill with the proper coolant mixture. Run engine with radiator cap off until operating temperature is reached and the thermostat opens. Recheck level and add coolant if required. Run the engine long enough to be sure the system is free of air and has the correct amount of coolant.

The coolant recovery bottle has fill indicators which should help you determine when the cooling system is at its capacity.



COOLING SYSTEM



CAUTION

The concentration of ethylene glycol in the cooling system must be checked with a hydrometer prior to traveling or operating in areas where sub-freezing temperatures may be encountered.

NOTE

Piping arrangement may cause capacity variation depending on the type of cooling system and optional external cooling devices which may be attached. Therefore it is difficult to tell exactly how much coolant it will take to fill any one particular system. As a general rule, you can fill to one inch below the bottom of the radiator filler neck. When making initial fill or adding ethylene glycol, operate the engine for twenty minutes and check the solution with a hydrometer.

CAUTION

DO NOT use coolant solutions which contain antileak additives in trucks equipped with coolant filters or conditioners.

DO NOT use soluble oil type coolant in ANY MACK cooling system.





DRIVETRAIN



To obtain peak efficiency and maximum performance, the operator will want to be familiar with certain aspects of the drive train with which he/she will be working. Gear ratios should be selected to allow engine operation between peak torque and rated speed.

CAUTION

Running the engine at an rpm that is too low for the load or grade of the road can cause damage to the drive train.

Shifting at the proper time will save both fuel and unnecessary repair bills, but remember that once your engine falls below the peak torque, both the torque and horsepower drop off very rapidly. Before this happens, downshift to the next lower gear.

On vehicles with transmissions having extreme reduction gearing, coupled with high rear axle loads, a torque limiting device will be used. This device limits the amount of fuel that can be delivered to the engine by the injection pump and prevents overloading of the drive train components while in extreme reduction gears.

Use the same gear going down hill as you would going up hill. This will save your brakes and prevent damaging the engine due to overspeeding.

ENGINE TEMPERATURE

Before entering high speed traffic conditions, allow the engine to reach operating temperature. Normal operating range may go between 170°F. and 225°F. depending on weather and road conditions. Engines do not normally overheat and the cause should be determined and corrected if overheating occurs.



MACK ENGINE



▲ CAUTION

Use of a winter front is NOT recommended. It can cause high exhaust temperature and serious engine damage. If a winter front is used a Mack approved pyrometer MUST be installed. Do NOT exceed the temperature limit shown on the pyrometer. To reduce temperature, open winter front, downshift or reduce engine power.

Don't permit load to drive engine above governed speed. Operate in a gear low enough to allow engine to accelerate to or to maintain governed rpm when applying throttle.

▲ WARNING

Misuse or modification of a turbocharger can result in serious injury and property damage. In addition, extreme care must be taken to avoid foreign material induction, excessive exhaust temperatures and lack of lubrication.

MODEL DESIGNATION

DESCRIPTION

The Mack engine unit symbol designation system is designed to provide total unit descriptive identification through a combination of prefix letters, numbers, digits and suffix letter as applicable.

PREFIX LETTERS AND NUMBERS

- E = MACK TURBOCHARGED DIESEL ENGINE
- M = MAXIDYNE ENGINE (HIGH TORQUE RISE)
- 7 = 728 CUBIC INCH DISPLACEMENT

DIGITS: PEAK GROSS HORSEPOWER (BHP)





NOTES





POWER TAKE-OFF UNIT



If the vehicle you are operating is equipped with a Power Take Off Unit (PTO), be sure you read and understand the following WARNING!

DANGER

POWER TAKE OFF (PTO) UNITS, and their related equipment can be very dangerous. Any PTO installation, repair or replacement should include a warning lamp which indicates PTO engagement. The lamp must be located close to the PTO control and clearly visible to the operator.

PTO units are driven by the engine or drive train components (flywheel, crankshaft, transmission). No work or service should be performed or attempted on the PTO and related units unless the engine is shut down. Always keep body parts and loose fitting clothing out of the range of these powerful components or personal injury may be the result.

Be sure you are aware of the PTO's engagement or nonengagement status and the position of the truck's body (dump body controlled by PTO, etc.). Be sure PTO is disengaged when not in use.

The way Mack rear-mounted PTO units are operated, places them in one of two categories. They are:

INTERMITTENT SERVICE—The PTO unit is operated, under load, for less than seven minutes and then allowed to cool before it is operated again.

CONTINUOUS SERVICE—The PTO unit is operated, under load, for seven minutes or more. Also, units operated for less than seven minutes and not allowed to cool down before operating again, should be considered continuous service.





POWER TAKE-OFF UNIT



Rear-mounted PTO units operating under the continuous service guideline must not be run at more than 70% of the PTO output rated torque/horsepower.

V-MAC

PTO operations controlled through V-MAC, differ from vehicles not equipped with V-MAC. See the **TS725** for information regarding the programming of PTO.



NOTES



TORQUE LIMITING CLUTCH BRAKE

When used properly, the torque limiting clutch brake prevents tang breakage which is prevalent in the conventional clutch brake. The torque limiting clutch brake provides an amount of internal free travel that allows for torsional oscillation to prevent fatigue.

NORMAL CLUTCH PEDAL TRAVEL

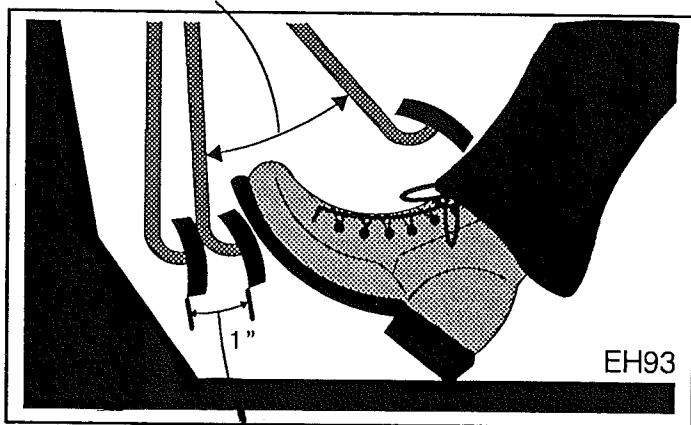

DEPRESS PEDAL LAST ONE INCH TO ENGAGE CLUTCH BRAKE.

With the vehicle standing still, disengage the clutch (carefully apply clutch brake to synchronize clutching teeth), shift to first or reverse gear, engage clutch and accelerate. The torque limiting clutch brake was designed to stop the input shaft of the transmission while the vehicle is stopped and the driver is attempting to shift into either first or reverse. It was not designed to be used as an upshifting clutch brake.

CAUTION

Once the vehicle is in motion, further clutch brake operation could damage the torque limiting clutch brake. The clutch brake must NOT be used when making a downshift or and upshift.



CLUTCH



NOTE

When the clutch is engaged, a slight but definite resistance to clutch pedal downward travel will be felt in the last one inch.

DOUBLE-CLUTCHING

As with all nonsynchronized transmissions, double-clutching is necessary on downshifts as well as upshifts. It is advisable to use the torque limiting clutch brake to engage first and reverse gears and to double-clutch for gear ratio changes.

DOUBLE-CLUTCHING is a means of bringing the speed of transmission gears into synchronization so that the shift can be made without clash. The engine is used to speed up the countershaft for a downshift and to slow it down for an upshift.

1. Depress clutch pedal and shift to neutral.
2. Let up clutch pedal and accelerate engine (when making downshift) or allow engine to slow down (upshift) until engine speed approximately corresponds to road speed of gear to be selected.
3. Depress clutch pedal and complete shift to desired gear. Release the clutch pedal.





TRANSMISSION



▲ CAUTION

Maximum safe oil temperature is 235°F. (113°C.). Continued operation with oil above this temperature will cause rapid deterioration of the oil's lubricating properties and is NOT RECOMMENDED.

▲ CAUTION

The vehicle must be completely stopped before attempting to shift from reverse to any forward speed or any forward speed to reverse or damage to transmissions may result.

TRTXL1070(B)* SHIFTING INSTRUCTIONS

* THE "B" DESIGNATION MEANS THAT INSTEAD OF A STICK SHIFT FOR THE FRONT COMPOUND, THERE IS A DASH MOUNTED SWITCH TO AIR SHIFT THE FRONT COMPOUND BETWEEN LOW AND DIRECT.

The TRTXL1070(B) is a twelve speed, triple countershaft, non-synchronized Maxitorque transmission. It consists of a five speed main box with an air shifted rear compound providing a Direct and Overdrive split in each of the five main box speeds, plus a manually shifted front compound providing a Direct and Low range for first speed gear. Due to a positive interlock, the only time Low range in the front compound can be used is with the main box in first gear.

NOTE

Main box cannot be shifted out of first gear until the front compound is in Direct.

Reverse (R) is located in the rear compound and therefore, five reverse speeds are available. Reverse is engaged by placing the Selectaire valve in reverse position and then placing the main box gear shift lever in one of the five forward speeds.



TRANSMISSION



STARTING OUT—Front Compound in Direct (D)

Engine is running and rear compound and main gear box are in neutral. The front compound is in Direct.

Depress the clutch pedal.

Shift the Selectair Valve (rear compound) to desired mode.

Shift the main gear box to first gear.

Release the clutch pedal and accelerate the engine.

STARTING OUT—Front Compound in Low (L)

Engine is running and rear compound and main gear box are in neutral. The front compound is in Direct.

Depress the clutch pedal.

Shift the main gear box to first gear.

Shift the front compound to Low.

Shift the Selectair Valve to Direct.

Release the clutch pedal.

Accelerate the engine.

Depress the clutch pedal and move the Selectair valve to Direct.

Release the clutch pedal and accelerate.





TRANSMISSION



MAIN AND REAR COMPOUND-Upshift

Select **Direct (D)** on Selectair Valve.

Release accelerator and depress clutch pedal.

Move the gear shift lever to next location.

Release clutch pedal and reapply accelerator.

MAIN AND REAR COMPOUND-Downshift

Select **High (H)** on Selectair Valve and downshift through normal procedure double-clutching as you go.

MAIN AND REAR COMPOUND-Reverse

Neutral (N) must be selected first in the main box before selecting reverse on the Selectair Valve.

Engage the gearshift lever in one of the forward speed positions, depending on how much speed is desired in reverse.

REAR COMPOUND-Upshift ONLY

Select **High (H)** on Selectair Valve.

Release and reapply accelerator

REAR COMPOUND-Downshift ONLY

Select **Direct** on Selectair Valve.

Release and reapply accelerator.

(Clutch pedal may be depressed for compound shifts.)



TRANSMISSION



TRTXL1070(B)

EH24

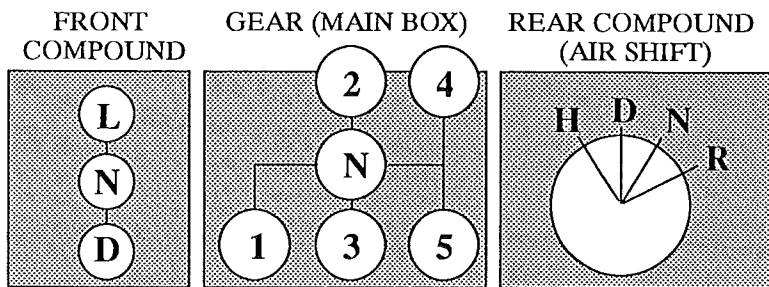

FRONT COMPOUND	GEAR (MAIN BOX)	REAR COMPOUND (AIR SHIFT)	RATIO
L	1	D	14.44
		H	11.23
		R	(47.96)
D	1	D	8.59
		H	6.68
		R	(28.52)
D	2	D	4.99
		H	3.89
		R	16.59
D	3	D	2.84
		H	2.21
		R	9.42
D	4	D	1.66
		H	1.29
		R	5.50
D	5	D	1.00
		H	.78
		R	3.32





NOTES





TRANSMISSION



T2050 SHIFTING INSTRUCTIONS

UPSHIFT

The T2050 is a five speed overgear transmission designed for general highway usage. This is a non-synchronized model that shifts through the use of a single shift in the traditional "H" pattern. Start out in first and shift up to second, third, fourth and fifth, double-clutching from one gear to the next.

DOWNSHIFT

Downshift in reverse order double-clutching through each gear.

▲ CAUTION

Do NOT overspeed the engine during downshifting. Damage to the drive train components may be the result.

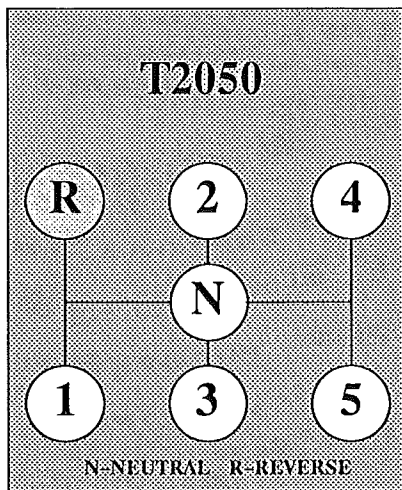

T2050	
GEAR	RATIO
(MAIN BOX)	
1	5.24
2	3.05
3	1.73
4	1.00
5	.60
R	5.38

E1123





T2060

The T2060 is a non-synchronized transmission. There is a Lo and Hi auxiliary section controlled by an air shift flipper. In Lo range you get one low ratio. In Hi range there are five forward gears which can be shifted in the standard manner, but remember to double-clutch whether moving up or down through the gears. For normal highway usage, start in Hi range, first gear and shift through second, third, fourth and fifth. The low range is designed for use off-highway and in slow moving (curb pouring, material spreading, heavy load/steep grade) operations. Reverse can be used in Low or Hi range.

UPSHIFT-2060

To upshift the T2060, begin in first gear Low range, depress the clutch pedal and release accelerator pedal. Flip air shift flipper to High range (you are still in first gear). Release the clutch pedal and apply the accelerator to reach the top of the operating range. Shift through second, third, fourth and fifth, double-clutching as you go.

DOWNSHIFT-T2060

To downshift the T2060, downshift as normal from fifth, fourth, third, second and first (don't forget to double-clutch all gears). When you get to the low end of the first high operating range, depress the clutch pedal, release the accelerator, and flip air shift to Low. Release the clutch pedal.

CAUTION

Do NOT overspeed the engine during downshifting. Damage to the drive train components may be the result.



TRANSMISSION



CAUTION

Do NOT preselect the air shift flipper on the T2060. Shift the rear compound only with the clutch pedal depressed and the gear shift lever in neutral.

T2060

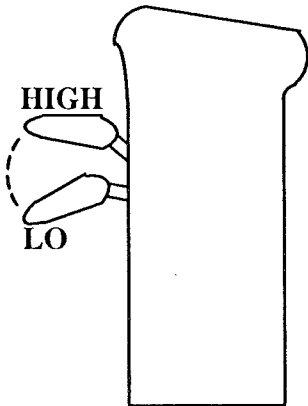

**AIR FLIPPER
SWITCH
LOCATED
ON THE
SHIFT LEVER**

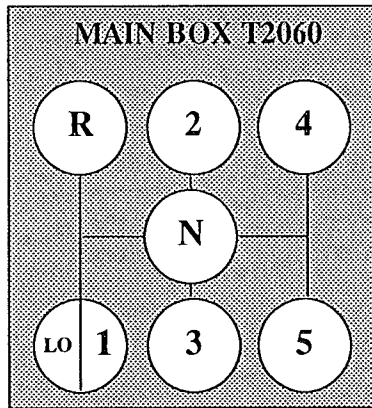

GEAR (Main Box)	RATIOS T2060	
	LO	HI
1	9.02	5.24
2	(5.25)	3.05
3	(2.98)	1.73
4	(1.72)	1.00
5	(1.03)	.60
EH13 R	9.25	5.38

() The ratios in parentheses are not practical to use.





T2070A

The T2070A is a non-synchronized transmission. There is a Lo and Hi auxiliary section controlled by an air shift flipper located on the shift lever. There is also a rear compound neutral valve switch located on the dash. In Lo range you get two low ratios. In Hi range there are five forward gears which can be shifted in the standard manner, but remember to double-clutch whether moving up or down through the gears. For normal highway usage, start in Hi range, first gear and shift through second, third, fourth and fifth. The two gears in low range are designed for off-highway use and in slow moving (curb pouring, material spreading, heavy load/steep grade) operations. Reverse can be used in Low or Hi range.

CAUTION

Do NOT preselect the air shift flipper on the T2070A. Shift the rear compound only with the clutch pedal depressed and the gear shift lever in neutral.

UPSHIFT-T2070A

To upshift the T2070A, begin in first gear, low range (commonly referred to as LO-LO, as shown on the shift pattern art). Upshift to second gear, low range (commonly referred to as LO) in the normal manner (double-clutch). When you are ready to upshift again, depress the clutch pedal and release the accelerator pedal. Move the stick to neutral. Flip the air shift switch up to High, double-clutch and move the stick back to first gear. You are now in first gear, High range (which is the next highest ratio). Release the clutch pedal and apply the accelerator pedal. Shift through the normal second, third, fourth and fifth procedures, double-clutching as you go.



TRANSMISSION



DOWNSHIFT-T2070A

To downshift the T2070A, downshift as normal from fifth to fourth, third, second to first in High range (double-clutch between them all). The next lowest shift will be to second gear, Low range (commonly referred to as LO). When you are ready for this gear, depress the clutch pedal and release the accelerator pedal. Move the stick to neutral and move the air shift switch to Low. Double-clutch and move the stick to second gear (LO). You are now in second gear, Low range. Your next lower gear (and lowest ratio in the T2070A) is first Low (LO-LO). Double-clutch down to first, Low range, at the proper time.

CAUTION

Do NOT overspeed the engine during downshifting. Damage to the drive train components may result.

OBTAINING NEUTRAL IN REAR (COMPOUND) CASE

The T2070A has a two position switch mounted on the dashboard which controls air flow to the rear compound. This allows the operator to obtain Neutral in the rear case if he wants it. When you switch to Neutral in the Rear (Compound) case, it allows you to operate the PTO with the vehicle stationary. In order to get into Neutral in the rear (compound) case, follow the procedure listed below.

1. Disengage the clutch.
2. Move the main box shift lever to Neutral.
3. Select Neutral on the dash mounted two position switch.
4. Select and engage the required main box ratio for PTO operation.
5. Engage the clutch.





TRANSMISSION

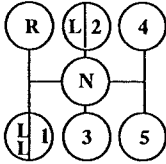

T2070A

MAIN BOX T2070A

GEAR (Main Box)	RATIOS T2070A	
	LO	HI
1	14.16	5.24
2	8.25	3.05
3	(4.67)	1.73
4	(2.70)	1.00
5	(1.62)	.60
R	14.53	5.38

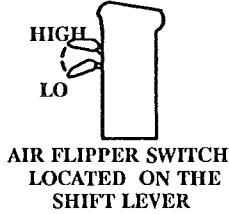

() The ratios in parentheses are not practical to use.

T2070B

To shift the T2070B, the same methods should be used in the forward speeds as in the T2070A. The only basic difference here is that you will be using an air shift selector on the stick shift for Direct, Low and Reverse.

To shift the T2070B in Reverse, use the air selector to put the transmission in reverse. Start in low gear (first speed reverse) and then shift as you normally would up to the desired reverse speed.

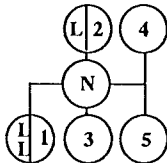

T2070B

MAIN BOX T2070B

GEAR (Main Box)	RATIOS T2070B		
	LO	D	R
1	14.16	5.24	12.42
2	8.25	3.05	7.23
3	(4.67)	1.73	4.12
4	(2.70)	1.00	(2.37)
5	(1.62)	.60	(1.42)

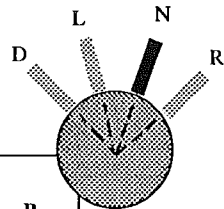

() The ratios in parentheses are not practical to use.



T2080 SHIFTING INSTRUCTIONS

The T2080 is a range shifted transmission with eight forward speeds. Low and high ranges are controlled by an air shift control button.

Never attempt to move type vehicle from a stopped position, in any gear higher than third Low. Depending on load, grade and road conditions you will very likely have to start in first Low or second Low. All three speeds in Low range are torque limited.

CAUTION

Do not move the air shift control button while moving in reverse. Also, when the truck is stationary do not shift into High range and then start moving the truck. Damage to the synchronizer may result.

UPSHIFT

Let's assume that we will need all eight forward speeds to get up to fifth High. This is how the vehicle should be shifted.

With shift lever in neutral, push the shift control button down and shift the transmission into first Low. Shift up through second Low and third Low, double-clutching between the gears. When maximum rpm has been reached in third Low, pull the air control button up (preselect) and then move the shift lever through neutral to first High. Your shift lever, when passing through neutral will put you in High range. Now follow the normal sequence (second High, third High, fourth High and fifth High) double-clutching your way to High gear.





TRANSMISSION



CAUTION

Be careful not to overspeed the engine during downshifting. Damage to the driveline may be the result.

DOWNSHIFT

To downshift the T2080, go from fifth High on down through High range (fourth High, third High, second High first High). While still in first High, push down on air shift control button (preselect) and move the shift lever through neutral to third Low. The move through neutral again activates the air shift mechanism, this time to Low range. Then shift down to second Low and first Low, double-clutching between all gears.

EH4

T2080

MAIN BOX

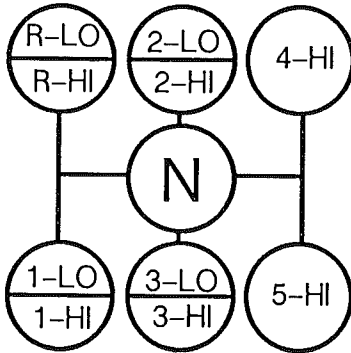

REAR COMPOUND

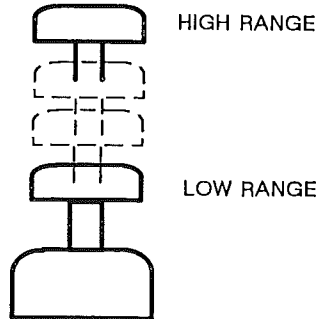

SPEED	LOW	SPEED	HIGH
FIRST	20.08	FOURTH	5.24
SECOND	11.68	FIFTH	3.05
THIRD	6.63	SIXTH	1.73
(FOURTH)	(3.83)	SEVENTH	1.00
(FIFTH)	(2.29)	EIGHTH	.60
REVERSE	20.61	REVERSE	5.38

() DENOTES RATIOS ARE NOT FUNCTIONAL TO OPERATIONS.



TRANSMISSION



T2080B

To shift the T2080B, the same methods should be used in the forward speeds as in the T2080. The only basic difference here is that you will be using an air shift selector on the stick shift for Direct, Low and Reverse.

To shift the T2080B in Reverse, use the air selector to put the transmission in reverse. Start in low gear (first speed reverse) and then shift as you normally would up to the desired reverse speed.

EH4B

T2080B

MAIN BOX

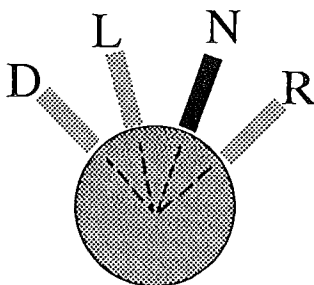
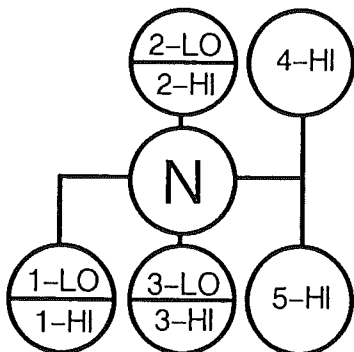

SPEED	REVERSE
FIRST	17.62
SECOND	10.25
THIRD	5.82
(FOURTH)	3.37
(FIFTH)	2.01

SPEED	LOW	SPEED	HIGH
FIRST	20.08	FOURTH	5.24
SECOND	11.68	FIFTH	3.05
THIRD	6.63	SIXTH	1.73
(FOURTH)	(3.83)	SEVENTH	1.00
(FIFTH)	(2.29)	EIGHTH	.60

() DENOTES RATIOS ARE NOT FUNCTIONAL TO OPERATIONS.





T2090 SHIFTING INSTRUCTIONS

CAUTION

Make sure air pressure is at least 100 psi before making range shifts. Warm units before making range shifts. Always start in Low range per shift label instructions, fourth or lower in T2090 and fifth or lower in T2100, including dynamometer testing. Do NOT select high range and attempt to move a stationary vehicle.

UPSHIFT

The T2090 is a range shifted transmission with eight forward speeds and an extra low gear in the Low range. Low and High ranges are controlled by an air shift control button. Under normal highway conditions, push the button down while shift lever is in neutral and shift the transmission into first gear (see shift pattern). Shift through second, third, fourth, double-clutching as you go. To continue while still in fourth gear, pull the air shift control button up (preselect) and then move shift lever through neutral to fifth gear (first position in Low range). As the shift lever passes through neutral, the air shift will be completed to high range. Now continue (double-clutching) through sixth, seventh and eighth.

The extra low gear was designed for off-highway use such as paving, material spreading and heavy load/steep grade conditions.

CAUTION

Do NOT move the air shift control button while moving in reverse. Also, when the truck is stationary, do NOT shift into High range and then start moving the truck. Damage to the synchronizer may result.



TRANSMISSION



DOWNSHIFTING

To downshift the the T2090, shift from eighth to seventh, sixth and fifth (don't forget to double-clutch between gears). While still in fifth gear, push the air control button to Low (preselect). As you shift through neutral, the range shift to Low will be completed. Move the shift lever to fourth, third, second and first.

CAUTION

Do NOT overspeed the engine during downshifting. Damage to driveline components may be the result.

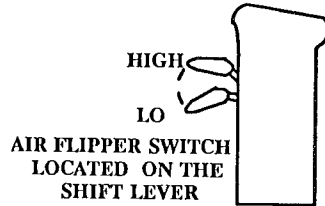
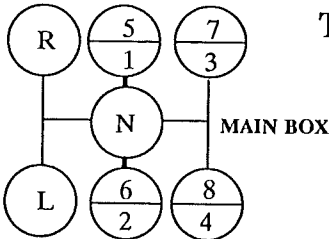

SPEED	LOW	SPEED	HIGH
LO	10.69	(LO)	(2.78)
FIRST	7.45	FIFTH	1.94
SECOND	5.33	SIXTH	1.39
THIRD	3.84	SEVENTH	1.00
FOURTH	2.73	EIGHTH	.71
REVERSE	10.92	(REVERSE)	(2.84)

() DENOTES RATIOS ARE NOT FUNCTIONAL TO OPERATIONS.

T2090B* The only difference between the T2090 and the T2090B is that the T2090B has a low gear ratio of 11.80 instead of the 10.96 of the T 2090.

SPEED	LOW	SPEED	HIGH
LO	* 11.80	LO	(3.08)
FIRST	7.45	FIFTH	1.94
SECOND	5.33	SIXTH	1.39
THIRD	3.84	SEVENTH	1.00
FOURTH	2.73	EIGHTH	.71
REVERSE	10.92	(REVERSE)	(2.84)

() DENOTES RATIOS ARE NOT FUNCTIONAL TO OPERATIONS.

* INDICATES LOW RATIO ON T2090B ONLY





TRANSMISSION



ALTERNATIVE SHIFT PATTERN

NOTE

The following information is a preferred alternative to the shift pattern on the previous page.

An alternative shift pattern can be used in the operation of the T2090. Although either shift pattern is acceptable, the alternate shift pattern is preferred and reduces transmission noise in fourth gear. No changes have been made to the transmission.

ORIGINAL SHIFT PATTERN FOR THE T2090 AND T2090B

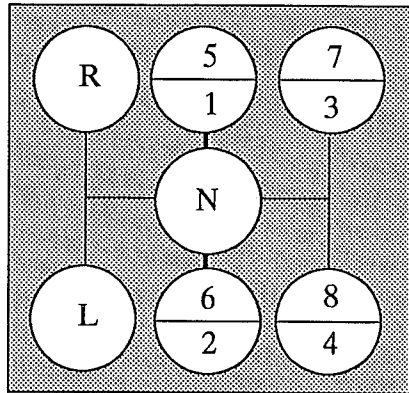

PREFERRED ALTERNATIVE PATTERN FOR THE T2090 (THIS PATTERN CANNOT BE USED FOR THE T2090B)

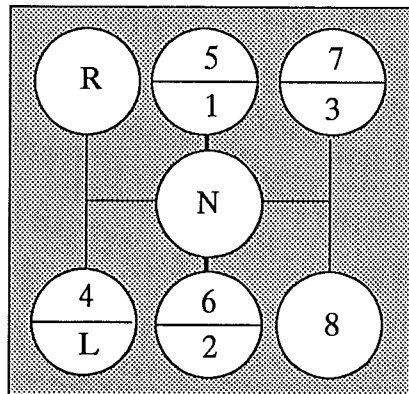



TRANSMISSION



T2100 SHIFTING INSTRUCTIONS

CAUTION

Make sure air pressure is at least 100 psi before making range shifts. Warm units before making range shifts. Always start in Low range per shift label instructions, fourth or lower in T2090 and fifth or lower in T2100, including dynamometer testing. Do NOT select high range and attempt to move a stationary vehicle.

UPSHIFT

The T2100 is a range shifted transmission with ten forward highway speeds. Low and High ranges are controlled by an air shift control button. The T2100 is designed for highway travel. With shift lever is in neutral push the shift control button down and shift the transmission into first gear (see shift pattern). Shift through second, third, fourth and fifth, double-clutching as you go. When maximum rpm has been reached in fifth, pull the air control button up, (preselect) and then move shift lever to sixth gear (first position in Low range). As the shift lever passes through neutral, the air shift will be completed to high range. Now continue (double-clutching) through seventh, eighth, ninth and tenth doubleclutching as you go.

The extra low gear was designed for off-highway use such as paving, material spreading and heavy load/steep grade conditions.

CAUTION

Do NOT move the air shift control button while moving in reverse. Also, when the truck is stationary, do NOT shift into High range and then start moving the truck. Damage to the synchronizer may result.





TRANSMISSION



DOWNSHIFTING

To downshift the the T2100, shift from tenth on down through Hi range (ninth, eighth, seventh and sixth). While still in sixth gear, push the air shift control button to (preselect) . As you shift through neutral to fifth, the range shift to Low will be completed. Move the shift lever to fourth, third, second and first.

EH12B

T2100

MAIN BOX

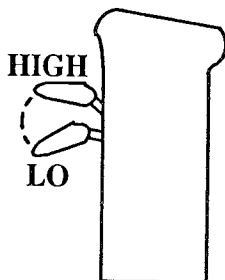
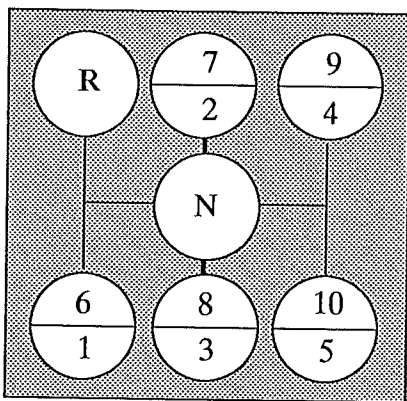

**AIR FLIPPER
SWITCH
LOCATED
ON THE
SHIFT LEVER**

SPEED	LOW	SPEED	HIGH
FIRST	8.52	SIXTH	2.22
SECOND	6.50	SEVENTH	1.70
THIRD	4.99	EIGHTH	1.30
FOURTH	3.84	NINTH	1.00
FIFTH	2.94	TENTH	.77
REVERSE	11.76	(REVERSE)	(3.06)

EH12B

() DENOTES RATIOS ARE NOT FUNCTIONAL TO OPERATIONS.



TRANSMISSION



T2130 SHIFTING INSTRUCTIONS

CAUTION

Make sure air pressure is at least 100 psi before making range shifts. Warm unit before making range shifts. Always start in low range per shift label instructions. This also applies to dynamometer testing. Do NOT select High range and attempt to move a stationary vehicle.

The T2130 is a range shifted transmission with twelve forward highway speeds and an extra low gear in the low range. Lo and Hi ranges are controlled by an air shift control button. The air shift splitter section can be preselected and controlled by the splitter toggle switch on the hand control valve.

NOTE

If you chose to preselect a gear, especially under heavy loads the splitter will not shift until the driveline torque is relieved. This can be done by depressing the clutch pedal and releasing or by backing off the throttle and then reapplying it.

Let's assume we have a full load and we are ascending a slight grade, for the purpose of showing a shift procedure through ALL the gears.





UPSHIFTING

When you start the vehicle, put the shift lever in neutral, **select low with the splitter switch, move the range shift down** to select low range. Engage first low with the lever (see shift pattern). To upshift the T2180, move the splitter switch to high (preselect) and when the engine reaches its peak rpm, release the accelerator pedal long enough to allow the upshift to take place. For the next upshift, move the splitter switch to low (preselect) and move the shift lever into second gear. The splitter shift will complete with rising engine speed. Flip the splitter to high and either actuate the clutch or get off the accelerator to complete the shift to second high. Repeat this procedure for third low and high and fourth low and high, double-clutching as you go. At this point you must use the range shift switch to get fifth low, fifth high, sixth low, sixth high, and so on through the low and high split until you reach eighth high.

NOTE

When upshifting with the splitter in high or low range, accelerate engine to governed speed, move splitter to high, depress and release clutch and back off accelerator pedal. Reapply accelerator when audible shift is heard or when engine speed falls by approximately 200 rpm. Tapping the clutch pedal may not be necessary to break the driveline torque, but this will vary depending on road and load conditions.

The extra low gears in low range were designed for off-highway use such as paving, material spreading and heavy load/steep grade conditions.



DOWNSHIFTING

To downshift the T2180, shift from eight high to eighth low, seventh high, seventh low, sixth high, sixth low, fifth high, to fifth low double-clutching for lever moves only. This is accomplished by using the splitter from high to low range.

NOTE

When downshifting with the splitter in high, as engine speed falls, move the splitter to low, release and reapply the accelerator pedal. An audible shift completion should be heard.

To continue while in fifth low, flip the range lever down to the low range position (preselect) and as you move gear shift lever through neutral to fourth gear, move the splitter switch from low to high. As the lever moves through neutral, the air shift will be completed to fourth high. At this point you can downshift using the splitter switch from fourth high to low, third high to low, etc. down to first low.

▲ CAUTION

Do NOT overspeed the engine during downshifting. Damage to the driveline components may be the result.





UPSHIFTING

When you start the vehicle, put the shift lever in neutral. Flip the **range shift switch up** so it is in high range. (This must be done before the splitter switch can be selected to low due to a mechanical interlock.) **Select low with the splitter switch.** Now **move the range shift switch down** to make sure the splitter is toggled for low range.

To upshift the T2130, Shift the gear lever into first gear (see shift pattern). Shift through second, third and fourth gears double-clutching as you go. To continue while in fourth gear, flip the range lever to the high position (preselect) and then move gear shift lever through neutral to fifth gear. As the lever moves through neutral, the air shift will be completed to high range. At this point you must use the splitter to get fifth high, sixth low, sixth high, and so on through the low and high range until you reach eighth high.

NOTE

When upshifting with the splitter in high range, accelerate engine to governed speed, move splitter to high, tap clutch and back off accelerator pedal. Reapply accelerator when audible shift is heard or when engine speed falls by approximately 200 rpm. Tapping the clutch pedal may not be necessary to break the driveline torque, but this will vary depending on road and load conditions.

The extra low gear in low range was designed for off-highway use such as paving, material spreading and heavy load/steep grade conditions.



TRANSMISSION



DOWNSHIFTING

To downshift the T2130, shift from eight high to eighth low, seventh high, seventh low, sixth high, sixth low, fifth high, to fifth low double-clutching and between the gears. This is accomplished by using the splitter from high to low range.

NOTE

When downshifting with the splitter in high range, as engine speed falls, move the splitter to low range, release and reapply the accelerator pedal. An audible shift completion should be heard.

To continue while in fifth low, flip the range lever down to the low range position (preselect) and then move gear shift lever through neutral to fourth gear. As the lever moves through neutral, the air shift will be completed to low range. At this point you can downshift in as normal manner from fourth to third, second and first.

⚠ CAUTION

Do NOT overspeed the engine during downshifting. Damage to the driveline components may be the result.





TRANSMISSION



T2130 and T2130B MAIN BOX

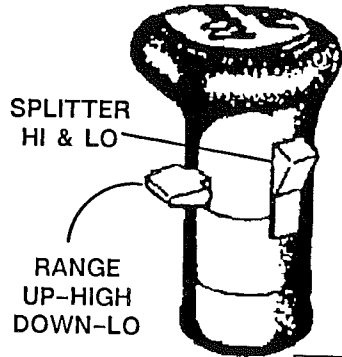
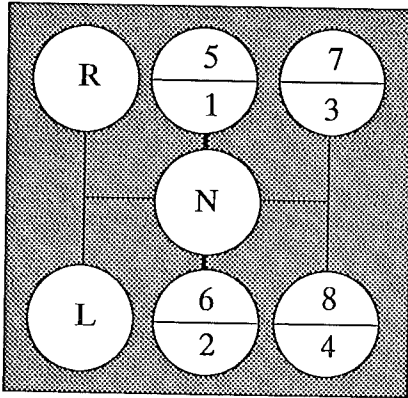

EH32

GEAR	SPLITTER	RANGE	T2130	T2130B
LO	LO	LO	13.91	13.91
1	LO	LO	8.78	8.78
2	LO	LO	6.28	6.28
3	LO	LO	4.52	4.52
4	LO	LO	3.22	3.22
RANGE SHIFTER HERE				
5	LO	HI	2.29	2.29
5	HI	HI	1.94	1.94
6	LO	HI	1.64	1.64
6	HI	HI	1.39	1.39
7	LO	HI	1.18	1.18
7	HI	HI	1.00	1.00
8	LO	HI	0.84	0.84
8	HI	HI	0.71	0.71
R	LO	LO	28.98	12.88
R	LO	HI	7.56	3.36
R	HI	HI	6.41	2.85

() DENOTES RATIOS ARE NOT FUNCTIONAL TO OPERATIONS.



TRANSMISSION



T2180 SHIFTING INSTRUCTIONS

▲ CAUTION

Make sure air pressure is at least 100 psi before making range shifts. Warm unit before making range shifts. Always start in low range per shift label instructions. This also applies to dynamometer testing. Do NOT select High range and attempt to move a stationary vehicle.

The T2180 is a range shifted transmission with sixteen forward highway speeds and two extra low gears in the low range. Lo and Hi ranges are controlled by an air shift control button. The air shift splitter section can be preselected and controlled by the splitter toggle switch on the hand control valve.

NOTE

If you chose to preselect a gear, especially under heavy loads the splitter will not shift until the driveline torque is relieved. This can be done by depressing the clutch pedal and releasing or by backing off the throttle and then reapplying it.

Let's assume we have a full load and we are ascending a slight grade, for the purpose of showing a shift procedure through ALL the gears.





TRANSMISSION



MAIN BOX

T2180 and T2180B

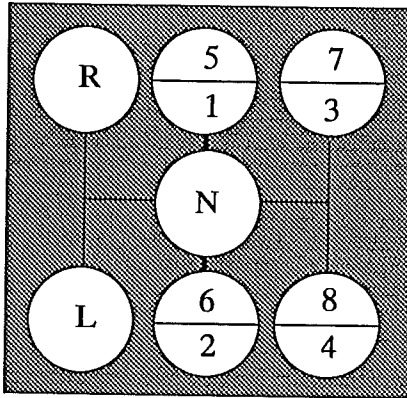

SPLITTER
HI & LO

RANGE
UP-HIGH
DOWN-LO

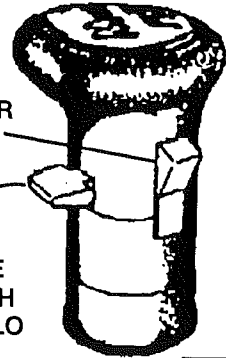

EH33

GEAR	SPLITTER	RANGE	T2180	T2180B
LO	LO	LO	13.91	13.91
LO	HI	LO	11.80	11.80
1	LO	LO	8.78	8.78
1	HI	LO	7.45	7.45
2	LO	LO	6.28	6.28
2	HI	LO	5.33	5.33
3	LO	LO	4.52	4.52
3	HI	LO	3.83	3.83
4	LO	LO	3.22	3.22
4	HI	LO	2.73	2.73
RANGE SHIFTER HERE				
5	LO	HI	2.29	2.29
5	HI	HI	1.94	1.94
6	LO	HI	1.64	1.64
6	HI	HI	1.39	1.39
7	LO	HI	1.18	1.18
7	HI	HI	1.00	1.00
8	LO	HI	0.84	0.84
8	HI	HI	0.71	0.71
R	LO	LO	28.98	12.88
R	HI	LO	24.58	10.92
R	LO	HI	7.56	3.36
R	HI	HI	6.41	2.85

() DENOTES RATIOS ARE NOT FUNCTIONAL TO OPERATIONS.



NOTES





REAR AXLE



Mack Trucks, Inc.® provides axle housings in three capacity classifications. They are medium-duty, heavy duty and extra heavy-duty. To deliver the appropriate amount of torque to the driving wheels, Mack Trucks, Inc.® offers single reduction and dual reduction carriers in a large variety of ratios for single axle applications. When required, a large variety of four wheel drive, two axle bogies are also available with top mounted, dual reduction carriers for straight line through drive. The bogie carriers are also available in a large number of ratios.

All four wheel drive bogie tandem carriers are available with the Mack Inter-Axle Power Divider third differential, with or without a driver controlled lockout.

Mack rear axles are designed so the entire load is carried by the axle housing through the wheel bearings mounted on the housing spindle. The rear axle shafts can be either free-splined, both ends, or integral flange type. Both types of axle shafts may be removed without removing or disturbing the rear wheels.

To avoid excessive tire wear, good maintenance must be practiced in the matching or tires on bogies without a compensating inter-axle power divider.

CAUTION

Maximum safe oil temperature is 235°F. (113°C.). Continued operation with oil above this temperature will cause rapid deterioration of the oil's lubricating properties and is NOT RECOMMENDED.



TWO SPEED REAR AXLE



The double reduction rear axle carrier employs selective fast and slow gear reductions. Electric shift (button on the transmission shifter lever) provides either fast or slow ratio by selecting these gearsets. The transmission is shifted in the usual manner and the two speed axle is shifted in the usual manner. The two speed axle is shifted as follows:

SPLIT SHIFTING

To shift to higher transmission gear and low axle speed at the same time (split shifting):

1. Make transmission shift to higher gear in the usual way.
2. Push the axle shifter button down just before re-engaging the clutch.
3. Re-engage clutch and depress the accelerator to maintain road speed.

To shift to lower transmission gear and high axle speed at the same time (split shifting):

1. Hold accelerator down and pull axle shifter up.
2. Shift to lower transmission gear in the usual way, then depress accelerator to maintain road speed.

CAUTION

Always keep accelerator down when shifter button is moved except when split shifting to low axle speed.

Vehicle must be brought to a full stop before shifting from forward to reverse and vice-versa.





TWO SPEED REAR AXLE



TO SHIFT AXLE FROM LOW TO HIGH SPEED:

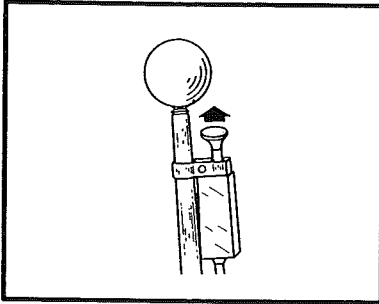

Shifter button
up (Hi)

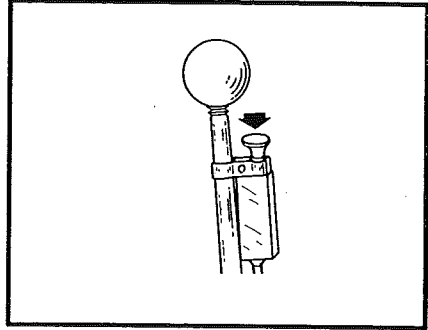

Up, pause and
down on
accelerator

1. Hold accelerator down.
2. Pull axle shifter button up.
3. Ride with accelerator down until you want to complete shift. Release accelerator, pause until shift is completed, then depress accelerator to maintain road speed.



TWO SPEED REAR AXLE



TO SHIFT AXLE FROM HIGH TO LOW SPEED:

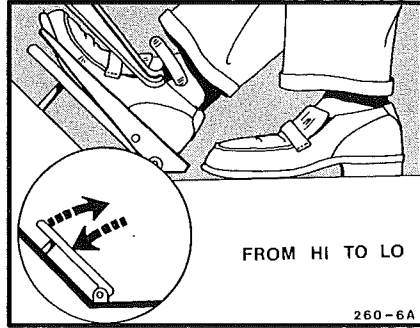
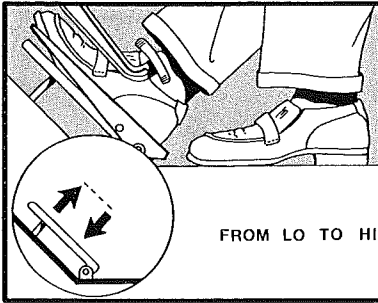

Shifter button
down (low)

Up and down on accelerator quickly without declutching, or hold accelerator down while disengaging and re-engaging clutch as quickly as possible.

1. Push axle shifter button down.
2. Hold accelerator down until you want to shift.
3. Disengage and re-engage clutch as quickly as possible while holding accelerator down OR release and depress accelerator as quickly as possible without declutching.





NOTES





HOSE TENDERS



▲ CAUTION

AVOID LOOSE HOSES. Air lines and tractor to trailer electrical connections must be secured to the tractor's hose tenders (hose hanger, towel bar, pogo stick, etc.) to avoid getting them tangled in the drive line.





BRAKE OPERATION

This truck has been built to meet or exceed all applicable federal standards and regulations.

The air brake system consists of three main elements.

- The **compressor with governor and reservoirs** supply the air pressure.
- The **brake application valve** controls the braking pressures.
- The **brake chambers** perform the work on the truck brake mechanism.

Mack vehicle design has incorporated into this chassis a dual braking system. It has two complete air circuits, a primary circuit for rear brakes and a secondary circuit for front brakes. Each circuit receives air from separate reservoirs. Although there are two air circuits, they operate as one brake system through the dual circuit treadle valve. This provides the driver with an easy, graduated control of applying and releasing the brakes.

The air pressure in the two air brake circuits is monitored by air pressure gauge[s] on the dashboard. (See information about air pressure gage(s) listed in the section on Panel C). When air pressure drops below 65 ± 5 psi (448 ± 34 kPa) in either primary or secondary air system, at any time other than vehicle startup, pull to the side of the road and determine problem. If air pressure continues to drop below 40 ± 5 psi in both systems, spring brakes will begin to be automatically applied. The low air pressure warning light or buzzer will be activated if low air pressure in either circuit occurs.



BRAKES



Driver caution should be exercised as this braking system is more sensitive to foot brake pressure and truck may stop in shorter distance than vehicles not equipped with this type of system.

CAUTION

Avoid sudden stops because constantly making such stops may have a negative effect on the performance of braking and driving parts.

When slowing for a stop, leave clutch engaged as long as possible to utilize the braking effect of the engine. When forward speed has dropped to a little above idling speed, push clutch pedal in and brake to a complete stop.

NOTE

The Mack puff limiter reversing relay normally bleeds a minute quantity of air unless the spring brake is applied. Whenever a vehicle is parked with the engine shut off and the spring brake not applied, the bleed air from the reversing relay will be audible. The bleed air from the reversing relay could be misinterpreted as a vehicle air leak and to stop the bleed air from escaping from the reversing relay, the parking (spring) brake must be applied.





PARKING BRAKE

Spring type parking brakes are standard on rear axles and bogies. The basic unit of a spring brake system is an air cylinder with heavy springs in it, either integrated with the service brake chamber or connected through linkage to the slack adjuster. It is so engaged in the brake linkage and thereby connected to the brake shoes, that with no air pressure in the spring cylinder, the springs expand and apply their force causing brake application. When air pressure is again applied to the air cylinder, it compresses the heavy springs, making them ineffective and thereby releasing the brakes.

The spring type parking brake can be controlled from the cab by use of a hand operated valve. In order to apply or release the auxiliary system, the control valve in the cab is moved by the driver as directed on the knob and decal.

At a predetermined reduced air pressure, in the event of air loss in the basic air system, the control will automatically exhaust the air from the spring chamber applying the brakes. Sufficient air pressure must then again be made available in the system to compress the heavy application springs.

CAUTION

NEVER use the trailer brake system alone as a parking brake. Use the tractor trailer brake system only. (It is activated by pulling the yellow diamond shaped knob on the dash panel.)



ANTI-WHEEL LOCK

INSTALLATION OF ELECTRICAL EQUIPMENT ON VEHICLES EQUIPPED WITH ANTI-WHEEL LOCK BRAKE SYSTEM

Connection of electrically powered or electrically controlled equipment to the vehicle may cause interference with the proper operation of other vehicle components. This interference may be dependent upon the operating frequency and the degree to which transient signals are coupled into the vehicle system.

Every user and installer of electrical equipment has the obligation to assure the proper operation of all electrical systems on the vehicle with respect to conducted or radiated signals by his installation.

"Specific attention is directed to the anti-wheel lock control brake system." A vehicle checkout procedure should include operating any added circuitry under the following test conditions.

1. Engine running and brake air system pressure in operating range.
2. Vehicle stationary.
3. Depress and hold brake pedal in full application pressure mode.
4. Operate added equipment in all its starting, running and shutdown conditions. Listen for any exhausting of air from anti-wheel lock controllers.
5. Any exhausting of air from anti-wheel lock controllers will indicate an interference condition which must be corrected before the vehicle is released for highway use.





! DANGER

Tires used on multipiece rims must be assembled and inflated only by experienced, qualified personnel. Tires must be inflated in a safety cage whenever possible. If, however a safety cage is not available, use a portable lock ring guard.

The tire must be deflated prior to removal of the tire and rim assembly from the vehicle. Remove the valve core to insure complete deflation.

! DANGER

NEVER POSITION YOUR BODY IN FRONT OF THE RIM DURING INFLATION.

The recommendations listed below, when followed, will provide the maximum in performance and mileage from your tires.

CORRECT INFLATION PRESSURE

In order to insure **MAXIMUM MILEAGE AND OVERALL PERFORMANCE** from your tires, it is essential that they operate at the **CORRECT INFLATION PRESSURE** for the **LOAD CARRIED**.

! WARNING

UNDER NO CIRCUMSTANCES should you drive on **UNDERINFLATED (OR OVERLOADED)** tires. A tire in this condition builds up **EXCESSIVE HEAT** which can result in sudden tire destruction, property damage and personal injury.



TIRES



At the end of this TIRE AND RIM section is a chart showing the maximum acceptable cold inflation pressures for the indicated loads for various tire sizes and types when used for NORMAL HIGHWAY OPERATION.

TIRE INSPECTION

Inspect your tires **daily**. Look for bulges, cracks, cuts, penetrations and/or oil contamination. If any such damage is found, the tire must be thoroughly inspected by a QUALIFIED TIRE INSPECTOR and repaired or discarded immediately, at his discretion.

Also, check for uneven wear. If found, a thorough inspection of front end parts and alignment should be made by a qualified mechanic.

TIRE MANUFACTURER'S DATA BOOK

Specific and more detailed information can be obtained by referring to the technical data books provided by each tire manufacturer.

Subjects of interest are:

- High speed or low speed operation
- Repair, retreading and regrooving
- Use of tire chains
- Mixing radial and bias tires on the same vehicle
- Use of dynamometers
- Tire mounting/dismounting

OIL CONTAMINATION OF TIRES

Lubricating oils, fuel oil, gasoline and other petroleum derivatives, if allowed to contact tires, will soften the rubber and destroy the tire. Preventive maintenance is necessary to insure that oil leakage does not occur. The following areas should be inspected on a regular basis:

- | | | |
|---|--------------------------|------------------|
| <input type="checkbox"/> Axle end seals | <input type="checkbox"/> | Drive axle seals |
| <input type="checkbox"/> Engine seals | <input type="checkbox"/> | Oil filters |
| <input type="checkbox"/> Transmission seals | <input type="checkbox"/> | Oil lines |





TIRES



TIRE PRESSURE CHART

Maximum cold inflation tire pressures (psi) are listed below.
Add five (5) psi for all radial tires. D=DUAL / S=SINGLE

TIRE SIZE DESIGNATION		LOAD RANGE (PLY RATING)			
		F(12)	G(14)	H(16)	J(18)
10.00-20 TUBE TYPE	D	75	90	105	-
	S	85	100	115	-
10.00-22 TUBE TYPE	D	75	90	105	-
	S	85	100	115	-
11.00-20 TUBE TYPE	D	75	90	105	-
	S	85	100	115	-
11.00-22 TUBE TYPE	D	75	90	105	-
	S	85	100	115	-
11.00-22.5 TUBELESS	D	75	90	105	-
	S	85	100	115	-
11.00-24 TUBE TYPE	D	75	90	105	-
	S	85	100	115	-
11.00-24.5 TUBELESS	D	75	90	105	-
	S	85	100	115	-
12.00-20 TUBE TYPE	D	-	80	95	105
	S	-	90	105	115
12.00-22.5 TUBELESS	D	75	90	105	-
	S	85	100	115	-
12.00-24 TUBE TYPE	D	-	80	95	105
	S	-	90	105	115
12.00-24.5 TUBELESS	D	75	90	105	-
	S	85	100	115	-
15.00-22.5 TUBELESS	S	-	85	100	-
16.5-22.5 TUBELESS	S	-	-	90	-
18.00-22.5 TUBELESS	S	-	-	85	100



WHEELS



WHEEL INSPECTION

Check pressure when tires are cold. Look at wheels and cap nuts. Inspect them for evidence of cap nut looseness. Rust streaks from the cap nut ball seat are an indication of looseness.

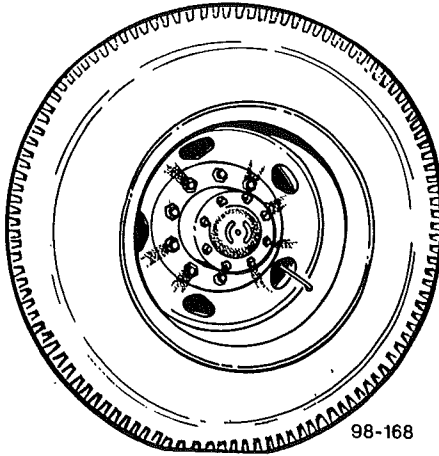

Look for cracks around the hand hole, stud hole and wheel. Look for broken studs, wheel damage or improperly seated lock rings.

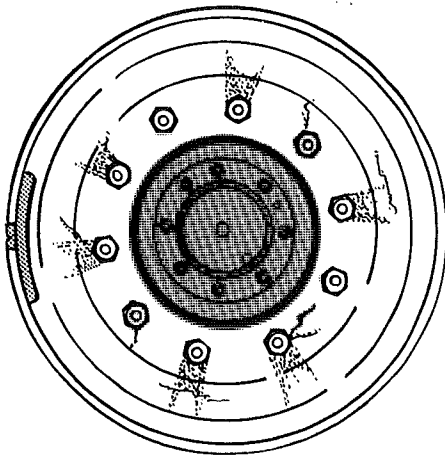



TOWING



▲ CAUTION

DO NOT LIFT AND TOW VEHICLE BY TOW CLEVISES.

There are two tow clevises located in the front bumper on the CH models. They meet the requirements set forth by The Management Council (TMC) for towing. The tow clevises may be used for towing a disabled vehicle from the immediate location.

NOTE

This practice is NOT intended for long term wrecker pull of disabled vehicles.



TOWING



TOWING WITH MACK AIR (AL) SUSPENSION

During vehicle towing, when the rear axles of a chassis with the Mack AL suspension are raised from the ground, the bogie is held in position by the fore-aft torque rods, transverse torque rod, and the shock absorbers.

To prevent damage to any of these components during rear towing, the following precautions should be taken.

1. Drain the air from the system (dump valve).
2. Using chains of suitable length, secure the axles to the frame.

CAUTION

Be sure that the chains do not rub against spring members, as this could adversely affect spring member life.

CAUTION

Tow truck operators must be trained in proper hook-up techniques, safety precautions, and the correct operation of their equipment to avoid vehicle damage and personal injury.





BATTERY



JUMP STARTING AN ENGINE

You may encounter a situation where it becomes necessary to jump start an engine. Be aware of a few simple rules.

▲ WARNING

Batteries which are to be linked together must be of the same voltage (12 to 12, 24 to 24).

Batteries produce explosive gasses. Keep sparks, flames, cigarettes, etc. away from batteries at all times.

Protect your eyes by wearing safety goggles.

Be sure vehicles are NOT touching each other.

1. Connect positive(+) cable to positive(+) post of discharged battery.
2. Connect the other end of the same cable to the positive(+) post of the booster battery.
3. Connect the second cable, negative(-) side, to the other post of the booster battery.
4. MAKE THE FINAL CONNECTION ON THE ENGINE BLOCK (of the stalled vehicle) AWAY FROM THE BATTERY AND STAND BACK.
5. Start the vehicle and remove the cables in the reverse order of connection.



METRICS



CAUTION

Potential external/internal thread mismatch condition(s) may occur with certain metric thread-inch thread fastener combinations, and with fastener combinations involving incompatible metric fastener systems. A given thread mismatch condition can result in thread stripping and/or assembly weakness leading to potential service failure, thereby rendering a vehicle non-operational and/or unsafe for operation.

The specific external/internal thread combinations from which such problems can result are identified and set forth in the TS494

When using tools on all fasteners, use them on the fasteners they were made to be used on. Use metric tools on SI metric units only. Never try to use metric tools on U.S. Inch-Pound Units or U.S. Inch-Pound tools on SI metric units. See conversion charts.

The first chart gives a U.S. to SI conversion.

U.S. TO SI CONVERSION CHART

1 inch	= 25.4 millimetres
1 mile	= 1.61 kilometres
1 pint (U.S. liquid)	= .473 litre
1 quart (U.S. liquid)	= .946 litre
1 cubic inch	= .01639 litre
1 pound-foot	= 1.3558 newton-metres
1 horsepower	= .746 kilowatt
1 pound/square inch	= 6.895 kilopascals
degrees Fahrenheit	= (1.8 X degrees Celcius) + 32
1 gallon (U.S. liquid)	= .83267 Imperial gallons





METRICS



The second chart shows SI to U.S. conversions.

SI TO U.S. CONVERSION CHART	
1 millimetre	= .03937 inches
1 kilometre	= .6214 miles
1 litre	= 2.1134 pints (U.S. liquid)
1 litre	= 1.0567 quarts (U.S. liquid)
1 litre	= 61.024 cubic inches (U.S. liquid)
1 newton-metre	= .7376 pound-feet
1 kilowatt	= 1.34 horsepower
1 kilopascal	= .145 pound/square inch
degrees Celcius	= .556 X (degrees Fahrenheit - 32)
1 imperial gallon	= 1.2009 gallons (U.S. liquid)



BULB CHART



12 VOLT SYSTEM

LAMP	QUANTITY	CP/ WATT	TRADE NO.
ABC GAGE PANEL CLUSTER LAMPS	26	1.0CP	#161
GAGE PANEL D	2	1.0CP	#161
DOME AND DOOR COURTESY LAMP	3	12.0CP	#561
MAP LAMP	1	3.0CP	#1816
HEATER AND AIR CONDITIONER	1	1.0CP	#184
CLEARANCE & CAB ID MARKER (STANDARD)	5	3.0CP	#168
CLEARANCE & CAB ID MARKER (PREMIUM)	5	4.0CP	#904
SIDE TURN INDICATOR	2	32.0CP	#570
HOOK-UP LAMP	1	35W/600CP	#4406
FOG LAMP	2	55W	#H3
HEADLAMP INCANDES- CENT ROUND	2	60W/50W	#6015
HEADLAMP, HALOGEN (ROUND)	2	65W/35W	#H6024
HEADLAMP, HALOGEN (RECTANGULAR)	2	65W/45W	#9004
REAR TAIL LAMP BACKUP	2	32.0CP	#1156
REAR STOP, TAIL AND TURN LAMP	2	32.0/3.0CP	#1157
FRONT TURN LAMP	2	32.0/3.0CP	#1157





CLOSING



PREVENTIVE MAINTENANCE IS THE KEY TO SAFE, COST EFFECTIVE OPERATION. THE MACK PREVENTIVE MAINTENANCE PROGRAM, OUTLINED IN THE MAINTENANCE AND LUBRICATION MANUAL (TS494) PROVIDES A GOOD BASE UPON WHICH A COMPLETE PREVENTIVE MAINTENANCE PROGRAM MAY BE BUILT. REMEMBER, A WELL BALANCED PREVENTIVE MAINTENANCE PROGRAM IS FAR LESS COSTLY BOTH IN TIME AND MONEY THAN DOWN TIME DUE TO PERSONAL INJURY OR VEHICLE BREAKDOWN.



NOTES





INDEX



A

- ADVISORY LABELS, 9
- AIR APPLICATION GAGE, 57
- AIR CONDITIONER CONTROLS, 67
- AIR HOSE LINES, 138
- ANTI-WHEEL LOCK, 142

B

- BATTERY, 149
- BRAKES
 - ANTI-WHEEL LOCK, 142
 - OPERATION, 139
 - PARKING, 141
- BULB CHART, 152
 - See also* LAMPS, REPLACEMENT

C

- CAB ENTRY, 33
 - DRIVER'S SIDE, 33
 - PASSENGER'S SIDE, 38
- CAB EXIT, 36, 41
 - DRIVER'S SIDE, 36
 - PASSENGER'S SIDE, 41
- CERTIFICATION LABELS, 30
- CIRCUIT BREAKERS, 74

- CLEARANCE LAMP SWITCH, 58
- CLUTCH, TORQUE LIMITING, 103
- CLUTCH PEDAL, 103
- COOLANT TEMPERATURE GAGE, 51
- COOLING SYSTEM, 95
- CUSTOMER SERVICE, 4
 - AUSTRALIA, 5
 - CANADA, 5
 - INTERNATIONAL, 5
 - UNITED STATES, 5

D

- DAILY INSPECTION, 86
- DOORS, 32
- DRIVETRAIN, 97
- DYNATARD ENGINE BRAKE SWITCH, 59

E

- ENGINE
 - MACK, TEMPERATURE, 98
 - MODEL DESIGNATION, 98
- ENGINE INFORMATION PLATE, 28
- ENGINE OIL TEMPERATURE GAGE, 53
- EXHAUST PYROMETER, 53



INDEX



F

FUEL GAGE, 57

H

HEATER AND AIR CONDITIONER, 68

FAN CONTROL SWITCH, 68

MODE SELECTION LEVER

TRUCKS WITH AIR CONDITIONER, 69

TRUCKS WITHOUT AIR CONDITIONER, 68

TEMPERATURE CONTROL LEVER, 69

HEATER CONTROLS, 67

HOOD, 76

HOOK UP/FOG LAMP SWITCH, 59

HOSE TENDERS, 138
See also AIR HOSE LINES

I

INDICATOR LAMP PANEL, 56

INSTRUMENT PANEL ARRANGEMENT, 50

INSTRUMENTS AND CONTROLS, PANEL A, 51

INSTRUMENTS AND CONTROLS

HEATER AND AIR CONDITIONER, 68

INTER-AXLE POWER DIVIDER, 64

PANEL B, 54

PANEL C, 56

PANEL D, 58

PANEL E, 66

INTER-AXLE POWER DIVIDER CONTROL, 64

J

JUMP START, 149

L

LAMPS, REPLACEMENT, 152

LIGHT SWITCH, 58

M

MACK ENGINE, 98

METRICS, 150

MIRROR DEFROSTER SWITCH, 59

MOVING THE VEHICLE, 94

O

ODOMETER, 55

OIL CHECK, 85

OIL PRESSURE GAGE, 52

OPERATION, 81



INDEX



P

- PANEL A, 51
- PANEL B, 54
- PANEL C, 56
- PANEL D, 58
- PANEL E, 66
- PARKING BRAKE VALVE, 67
- POWER TAKE-OFF UNIT,
100
- PTO. *See* POWER TAKE-OFF
UNIT

R

- REAR AXLE, 133
 - TWO SPEED, 134
- REPORTING SAFETY DE-
FECTS, 3
 - CANADIAN CONSUMER
COMPLAINTS, 3

S

- SEAT BELTS, 43
 - Seat Belts, Komfort Latch, 46
- SERVICE LITERATURE, 22
- SPEEDOMETER, 55
- STARTER SWITCH, 72
- STARTING
 - AIR START, 93
 - NORMAL, 91, 93
- STARTING THE VEHICLE, 88

- STEERING COLUMN, 70
- STEERING WHEEL ADJUST-
MENT, 73

T

- TACHOMETER, 55
- TELL-TALES, 49
- TIRE PRESSURE CHART, 145
- TIRES, 143
- TO THE OWNER, 8
- TOWING, 147, 148
- TRAILER SUPPLY VALVE, 67
- TRANSMISSION, 105
 - T2050, 110
 - T2060, 111
 - T2070A, 113
 - T2090, 119
 - T2100, 122
 - T2130, 124
 - T2180, 128
 - TRTXL1070(B), 105
- TRANSMISSIONS, T2080, 116
- TURN SIGNAL STICK, 70

U

- UNIT IDENTIFICATION
 - ENGINE WITH 4 VALVE
HEAD, 28
 - MACK COMPONENTS, 26
 - REAR AXLE, 27
 - TRANSMISSION, 27
 - VIN, ENGINE, 26

CH



INDEX



V

V-MAC, 7

VARIABLE SPEED CONTROL, 60

VEHICLE BREAK-IN, 84

VEHICLE CERTIFICATION LABELS

MACK COMPLETED VEHICLES, 30

MACK INCOMPLETE VEHICLES, 31

SAFETY CERTIFICATION LABEL, 30

VOLTMETER, 52

W

WARRANTY, 24

AIR BRAKE SYSTEM, 25

INJECTION PUMP AND GOVERNOR, 24

WHEEL INSPECTION, 146



NOTES





NOTES





NOTES





NOTES



TS71089 / PRELIMINARY / 8/88 / 1M
TS71091 / REVISED SEPTEMBER 1, 1990 / 10M
TS71093 / REVISED JUNE 1, 1992 / 10M
TS71094 / REVISED SEPTEMBER 8, 1993 / 10M
TS71095 / REPRINTED JULY 11, 1994 / 15M