

J
40-2-0
TM 9-816

TM 9-816

WAR DEPARTMENT TECHNICAL MANUAL

Case DFLC 310-62, 1 May 63

4- to 5-Ton 4x4 Tractor Truck (Autocar Model U-7144T)

WAR DEPARTMENT TECHNICAL MANUAL

TM 9-816

4- to 5-Ton
4x4 Tractor Truck
(Autocar Model U-7144T)



WAR DEPARTMENT

•

21 MARCH 1944

WAR DEPARTMENT
Washington 25, D. C., 21 March 1944

TM 9-816, 4- to 5-ton 4 x 4 Tractor Truck (Autocar Model U-7144T), is published for the information and guidance of all concerned.

[A.G. 309.7 (13 Dec 43)
O.O.M. 4617 (TM-9) Rev. Ans. (3-27-44)]

BY ORDER OF THE SECRETARY OF WAR:

G. C. MARSHALL,
Chief of Staff.

OFFICIAL:

J. A. ULIO,
*Major General,
The Adjutant General.*

DISTRIBUTION: X.

(For explanation of symbols, see FM 21.6.)



CONTENTS

PART ONE — VEHICLE OPERATING INSTRUCTIONS

SECTION		Paragraphs	Pages
	I. Introduction	1	5
	II. Description and tabulated data	2- 3	5- 8
	III. Driving controls and operation	4- 6	9- 15
	IV. Operation under unusual conditions	7- 10	15- 23
	V. First echelon preventive maintenance services	11- 15	23- 35
	VI. Lubrication	16- 17	35- 45
	VII. Tools and equipment storage on the vehicle	18	46- 49

PART TWO — VEHICLE MAINTENANCE INSTRUCTIONS

SECTION	VIII. Vehicle modification records	19	50
	IX. New vehicle run-in test	20- 21	50- 55
	X. Second echelon preventive maintenance	22	55- 85
	XI. Organization tools and equipment	23	85
	XII. Trouble shooting	24- 45	85-107
	XIII. Engine data, maintenance, and adjustment in vehicle	46- 55	107-119
	XIV. Engine removal and installation	56- 57	119-130
	XV. Clutch	58- 60	130-134
	XVI. Fuel system	61- 66	134-143
	XVII. Intake and exhaust system	67- 71	143-147

*This manual supersedes technical information TM 9-816, 16 Oct 44 and DFM 826-21, 27 Nov 45. This manual includes pertinent information from TM 9-150, 6 Mar 42, together with TM 9-118 and UN 9-187A, the manual superseded TM 9-816.

CONTENTS - Cont'd

	Photographs	Pages
XVIII. Cooling system	72- 78	148-157
XIX. Ignition system	79- 85	157-165
XX. Starting and generating systems	86- 92	165-174
XXI. Transmission	93- 95	175-179
XXII. Transfer case	96- 99	179-181
XXIII. Propeller shafts and universal joints	100-103	181-184
XXIV. Front axle	104-107	185-187
XXV. Rear axle	108-110	187-189
XXVI. Service brake system	111-127	189-212
XXVII. Propeller shaft brake system	128-132	212-215
XXVIII. Wheels, hubs, wheel bearings, and tires	133-135	216-219
XXIX. Springs and shock absorbers	136-138	220-225
XXX. Steering gear	139-143	225-228
XXXI. Body and frame	144-152	228-235
XXXII. Battery and lighting system	153-168	235-249
XXXIII. Instruments	169-176	250-255
XXXIV. Fifth wheel	177-179	256
XXXV. Radio noise suppression	180-184	257-261
XXXVI. Shipment and temporary storage	185-187	261-265
REFERENCES		266-267
INDEX		268-280

PART ONE — VEHICLE OPERATING INSTRUCTIONS

Section I

INTRODUCTION

1. SCOPE.*

a. This Technical Manual is published for the information and guidance of the using arm personnel charged with the operation, maintenance, and minor repair of the materiel.

b. In addition to a description of the 4- to 5-ton 4 x 4 Tractor Truck (Autocar Model U-7144T), this manual contains technical information required for the identification, use, and care of the materiel. The manual is divided into two parts. Part one, section I through section VII, gives operating instructions. Part two, section VIII through section XXXVI, gives vehicle maintenance instructions to using arm personnel charged with the responsibility of doing maintenance work within their jurisdiction.

c. In all cases where the nature of the repair, modifications, or adjustment is beyond the scope or facilities of the unit, the responsible ordnance service should be informed so that trained personnel with suitable tools and equipment may be provided, or proper instructions issued.

Section II

DESCRIPTION AND TABULATED DATA

2. DESCRIPTION (figs. 1 and 2).

a. The 4- to 5-ton 4 x 4 Tractor Truck (Autocar Model U-7144T) is a cab-over-engine vehicle. Power is furnished by an RXC model Hercules engine. When necessary power can be transmitted to the front wheels through a centrally located transfer case. Hub construction allows the wheels to be mounted dually at both front and rear. A support bracket behind the cab carries two spare tires. A large rectangular tank attached to the frame midway between the wheels on the left side carries fuel. A battery box and two air reservoir tanks are located in a similar position on the right side.

b. This tractor truck is manufactured in both open and closed cab-type vehicles.

*To provide operating instructions with the materiel, this Technical Manual has been published in advance of complete technical review. Any errors or omissions will be corrected by changes or, if extensive, by an early revision.

4- TO 5-TON 4 x 4 TRACTOR TRUCK (AUTOCAR MODEL U-7144T)

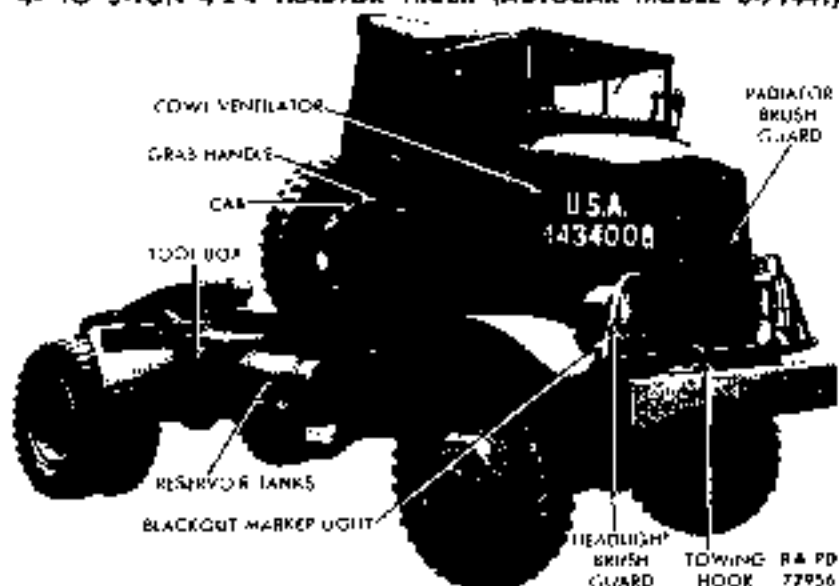

Figure 1 - Truck Right Front

3. DATA.

a. Vehicle Specifications.

Model	U-7144T
Wheel base	134 1/2 in.
Length, over-all	203 1/2 in.
Width, over-all	95 7/8 in.
Height, over-all	112 3/4 in.
Tire:	
Size	9.00 x 20
Type	10-ply, lug tread
Tread (center to center)	
Front	73 1/4 in.
Rear (inside)	59 3/4 in.
Rear (outside)	84 1/2 in.
Weight of vehicle:	
Empty	11,660 lb
Loaded	21,010 lb
Ground clearance:	
Front	11 3/8 in.
Rear	12 1/4 in.
Pintle height	38 in.
Grade of fuel	68 octane (min)

DESCRIPTION AND TABULATED DATA

RA PD 77947

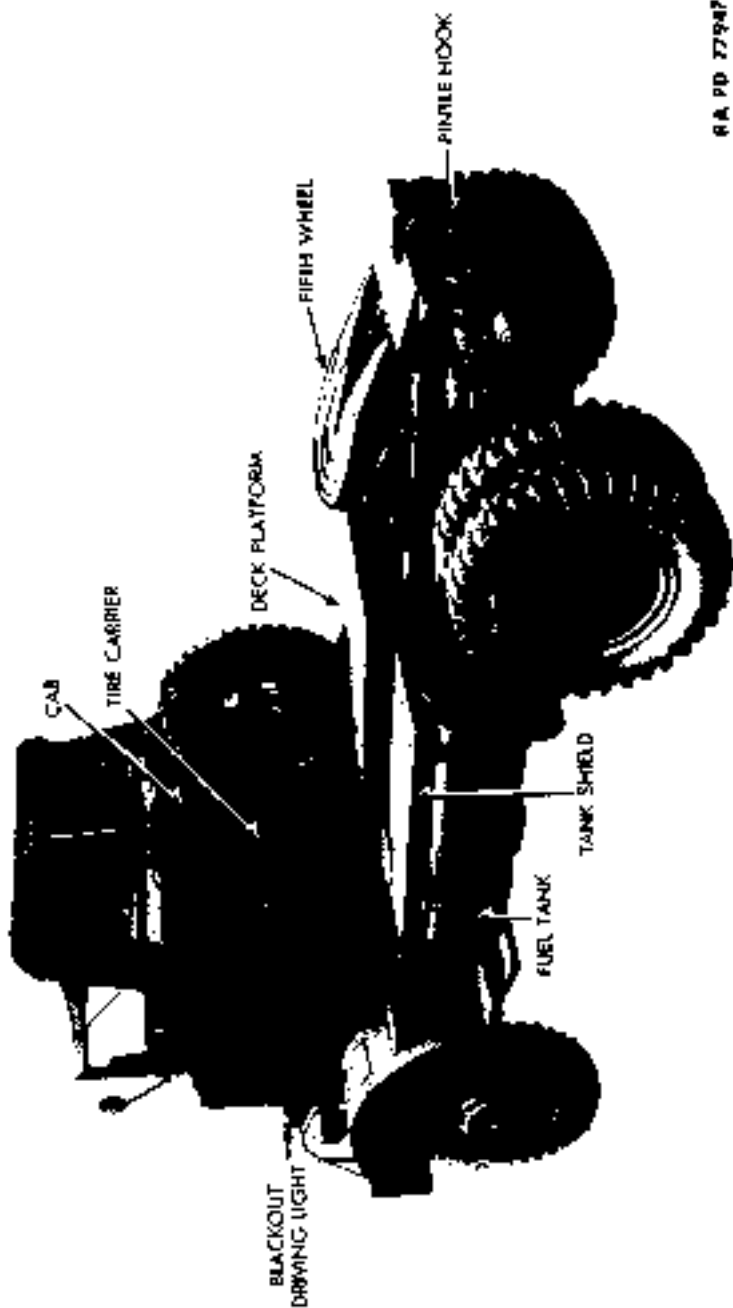

Figure 2 - Trach - Left Rear

4. 10 5-TON 4 x 4 TRACTOR TRUCK (AUTOCAR MODEL U-7144T)

b. Performance.

Speeds allowable:

Without front wheels driving:

First gear	5 mph
Second gear	9 mph
Third gear	18 mph
Fourth gear	33 mph
Fifth gear	41 mph

With front wheels driving:

First gear	5 mph
Second gear	9 mph
Third gear	10 mph
Fourth gear	10 mph
Fifth gear	10 mph

Minimum turning radius. 30 ft

Towing facilities:

Front	Two hooks
Rear	One pintle

Maximum drawbar pull 450 lb (4th gear)

Maximum governed engine speed 2,300 rpm

Miles per gallon 3 to 5

Cruising range 180 miles

c. Capacities.

Transmission capacity:

Summer	7 qt
Winter	9 qt

Transfer case capacity 2 qt

Front axle capacity 8 qt

Rear axle capacity 10 qt

Fuel capacity 60 gal

Cooling system capacity 40 qt

Crankcase capacity 12 qt

Oil bath air cleaner capacity 3 pt

Steering gear capacity 1½ pt

Section III

DRIVING CONTROLS AND OPERATION**4. CONTROLS.**

a. **Transfer Case Shift Lever** (fig. 3). This lever is located in the cab between the main transmission gearshift lever and the front axle declutching lever, and is used to engage the high and low speed gears in the transfer case. **NOTE:** *The low speed gear cannot be engaged unless the front axle declutch lever is in the "IN" position (fig. 3).*

b. **Front Axle Declutch Lever** (fig. 3). This lever is located at right of transfer case shift lever. It engages and disengages the front axle drive. Placing it in the "IN" position automatically carries the transfer case shift lever to the "LOW" range position. Declutch lever can be operated independently only when the transfer case shift lever is in the "HIGH" range.

c. **Main Transmission Gearshift Lever** (fig. 3). This lever is located at the left of transfer case shift lever, and is used to shift all gears in the main transmission.

d. **Propeller Shaft Brake Lever** (fig. 3). This lever, located next to the operator, controls the propeller shaft brake at the rear of the transfer case.

e. **Service Brake Pedal** (fig. 3). This pedal is located on the right side of the steering column, and operates the service brake to stop vehicle.

f. **Clutch Pedal** (fig. 3). The clutch pedal, located at the left side of the steering column, is used to engage and disengage the clutch. When properly adjusted, the clutch has approximately 1½ inches of free travel before it starts to release.

g. **Cranking Motor Switch** (fig. 19). This switch is located on the floor board in front of the operator's seat, and is used to complete electric circuit between battery and cranking motor.

h. **Foot Dimmer Switch** (fig. 3). This switch is located on the floor board at the left of the clutch pedal, and is used to raise and lower the headlight beam.

i. **Viscosity Gage** (fig. 3). This gage is located on the left side of the instrument panel, and indicates the viscosity of the engine oil in terms of "thin," "ideal," or "heavy."

j. **Ammeter** (fig. 3). This gage is located on the left side of the instrument panel. It indicates generator output in amperes varying with engine speed from 0-30.

4- TO 5-TON 4x4 TRACTOR TRUCK (AUTOCAR MODEL U-7144T)

- A—WINDSHIELD WIPER REGULATOR VALVES
- B—VISCOSITY GAGE
- C—HEADLIGHT AND BLACKOUT BRIGHT SWITCH
- D—AMMETER
- E—AIR PRESSURE GAGE
- F—AUXILIARY AMPMETER
- G—TACHOMETER
- H—SPEEDOMETER
- J—OIL PRESSURE GAGE
- K—INSTRUMENT LIGHT
- L—TEMPERATURE GAGE
- M—FOOT DIMMER SWITCH
- N—CLUTCH PEDAL
- P—HORN BUTTON
- O—BRAKE PEDAL
- R—HAND BRAKE VALVE OPERATING LEVER
- S—IGNITION SWITCH
- T—THROTTLE CONTROL
- U—FUEL GAGE
- V—INSTRUMENT LIGHTING SWITCH
- W—ACCELERATOR PEDAL
- X—PROPELLER SHAFT BRAKE LEVER
- Y—MAIN TRANSMISSION GEARSHIFT LEVER
- Z—FRONT AXLE DECLUTCH LEVER
- AA—TRANSFER CASE SHFT LEVER
- AB—GEARSHIFT FINISH PLATE

RA PD 77942

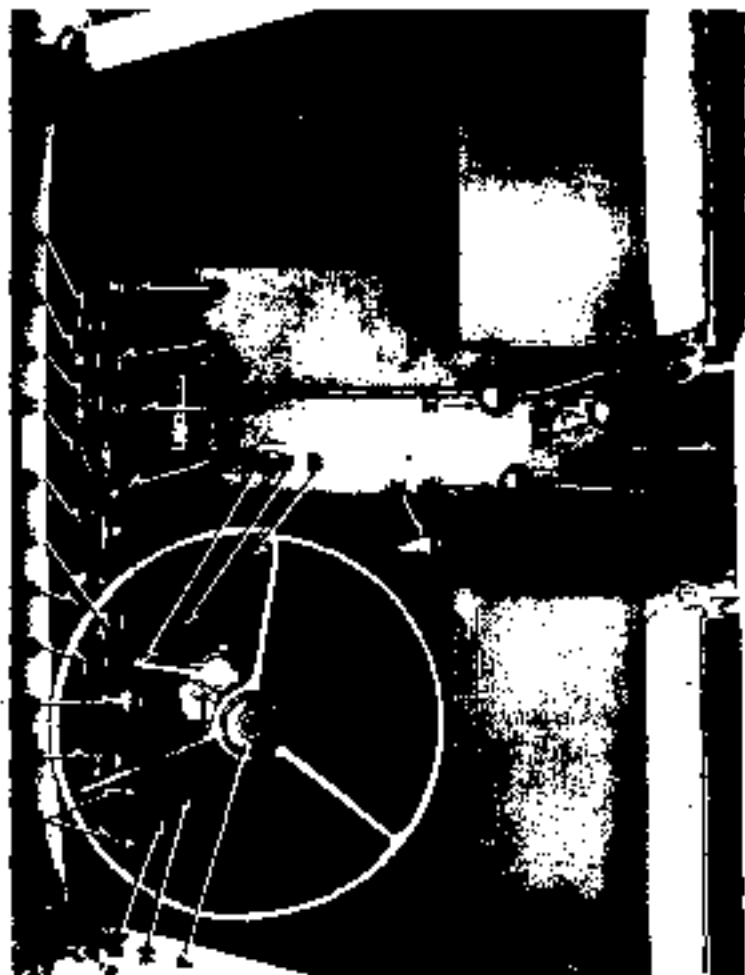
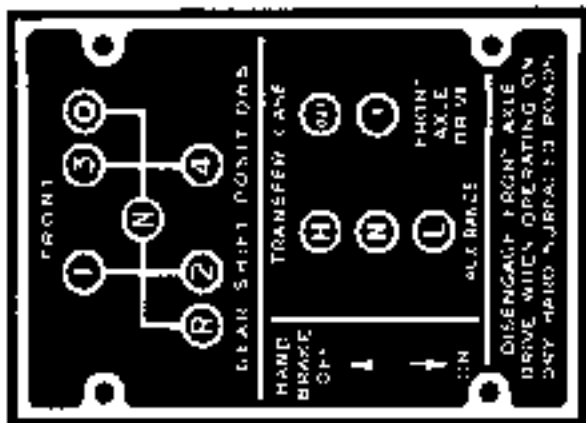

Figure 3 — Operator's Controls and Instrument Panel

DRIVING CONTROLS AND OPERATION



NA 90 77809

IF THE ENGINE IS OPERATED FOR ANY LENGTH OF TIME AT A SPEED GREATER THAN 2400 R.P.M. AS SHOWN BY THE ENGINE SPEED METER ON THE INSTRUMENT PANEL THE ENGINE WILL BE SERIOUSLY DAMAGED.

WARNING - BUZZER OPERATION IS AN INDICATION THAT THE TRUCK MUST IMMEDIATELY BE BROUGHT TO A STOP AND THE CAUSE OF LOSS OF BRAKE AIR PRESSURE DETERMINED.

TO DRAIN COOLING SYSTEM OPEN DRAIN COCKS AT BOTTOM OF RADIATOR AND ABOVE WATER PUMP IN CYLINDER BLOCK.

Figure 4 - Instruction Plates

4. TO 5-TON 4 x 4 TRACTOR TRUCK (AUTOCAR MODEL U-7144T)

k. **Auxiliary Ammeter (fig. 3).** This gage is located on the left side of the instrument panel to the right of the ammeter. It indicates the charge or discharge operation of the auxiliary 6-volt battery.

l. **Air Pressure Gage (fig. 3).** This gage, located at the center of the instrument panel, shows the amount of air pressure available in the service brake system.

m. **Tachometer (fig. 3).** The tachometer is located at the center of the instrument panel. The black hand shows engine speed in revolutions per minute. The instrument is equipped with a key that is used to reset the red hand which registers the highest revolutions per minute the engine has been operated.

n. **Speedometer (fig. 3).** This gage is located at the center of the instrument panel. It indicates road speed and records total miles and trip miles.

o. **Oil Pressure Gage (fig. 3).** This gage is located at the center of the instrument panel at the right side, and indicates oil pressure.

p. **Temperature Gage (fig. 3).** This gage is located on the right side of the instrument panel, and indicates temperature of fluid in the engine cooling system.

q. **Fuel Gage (fig. 3).** This gage is located on the right side of the instrument panel. It shows the quantity of fuel in the fuel tank, when ignition switch is turned on.

r. **Windshield Wiper Regulator Valves (fig. 3).** These two valves are located on the left side of the instrument panel, and their function is to control the speed of the two wiper arms.

s. **Headlight and Blackout Light Switch (fig. 3).** This switch is located on the instrument panel behind the steering column. It controls all lights and operates in four positions.

t. **Choke Control.** This control is located at the center of the instrument panel. It is used to reduce the amount of air admitted to the carburetor, thus giving various degrees of a richer fuel mixture.

u. **Ignition Switch (fig. 3).** This switch is located at the center of the instrument panel, and controls the engine electrical supply.

v. **Throttle Control (fig. 3).** This control is located at the center of the instrument panel to the right of the ignition switch. It serves as a hand throttle to increase or reduce engine speed.

w. **Instrument Lighting Switch (fig. 3).** This switch is located on the right side of the instrument panel. It is a rheostat type switch which controls instrument panel lights when the headlight and blackout light switch is in third position.

DRIVING CONTROLS AND OPERATION

x. **Hand Brake Valve Operating Lever** (fig. 3). This lever is attached to the steering column just below steering wheel, and independently controls the trailer brake.

y. **Accelerator Pedal** (fig. 3). This pedal is located at right of the service brake pedal, and it controls speed of the vehicle.

z. **Blackout Driving Light Switch**. This switch is located at the extreme left of the instrument panel. It controls the blackout driving light attached to the cowling above the left headlight.

aa. **Horn Button** (fig. 3). This button is located at the top center of the steering column, and gives operator manual control of horn.

5. OPERATION OF VEHICLE.

a. **Before-operation Service**. Perform the services in items 1 to 6 in paragraph 12 before attempting to start the engine. Start and warm up engine (subpar. b, below) and then complete the Before-operation Services.

b. **Starting the Engine**. Note instrument panel instruction plates (fig. 4). Set propeller shaft brake (fig. 3) to prevent vehicle from moving. Place main transmission gearshift lever in neutral position (fig. 4). If engine is cold, pull choke out all the way (fig. 3); otherwise, use partial choke or none at all. Pull out throttle control (fig. 3) about $\frac{1}{2}$ inch. Less throttle will be needed for a warm engine. Turn ignition switch to "ON" position (fig. 3). Depress clutch pedal (fig. 3), and hold down until engine starts. Depress cranking motor switch (fig. 19) until engine fires, then release immediately. Push in throttle control and choke control when engine runs smoothly. During the warm-up period, a buzzing noise will be heard, indicating insufficient air pressure to operate service brakes. Do not operate vehicle, except in an emergency, until this noise stops. Increase engine speed slightly to build up air pressure more rapidly. If buzzer sounds while vehicle is in operation, stop immediately and determine cause of loss of air pressure.

c. **Driving the Vehicle**. Disengage clutch by depressing clutch pedal. Place transfer case shift lever in either "HIGH" or "LOW" position (fig. 4) depending on load and road conditions. For heavy load use "LOW," for light load "HIGH." Vehicle cannot be moved while this lever is in neutral position. Move main transmission gearshift lever to the first gear position (fig. 4). Release propeller shaft brake lever (fig. 3). Depress accelerator pedal to increase engine speed gradually and slowly release clutch until clutch is fully engaged. Increase engine speed until truck gets under way. Shift main transmission into second gear as follows: Depress clutch pedal; place gearshift lever in neutral position; and engage clutch momentarily. De-

4. TO 5-TON 4 x 4 TRACTOR TRUCK (AUTOCAR MODEL U-7144T)

press clutch pedal again, and place gearshift lever in second position (fig. 4). Release clutch and increase engine speed. **CAUTION:** Do not exceed 2,400 revolutions per minute as indicated by tachometer (fig. 3). Repeat this operation, passing through all the gears consecutively until the highest gear is reached at which the engine pulls without laboring. To shift to a lower gear, use the same procedure as for shifting to a higher gear, with the following exception: When gearshift lever is in neutral position and clutch is momentarily engaged, accelerate engine to approximate speed required to propel vehicle at the same speed in the lower gear. Then disengage clutch and quickly shift to lower gear.

d. **Stopping the Vehicle.** Close throttle by removing foot from the accelerator pedal. Apply brake carefully by depressing service brake pedal. When the vehicle is nearly stopped, disengage clutch, and move main transmission gearshift lever in neutral position. When truck stops, apply propeller shaft brake; then release clutch and service brake pedals.

e. **Stopping the Engine.** To stop engine, turn ignition switch to "OFF" position, making sure switch is completely open to avoid running down battery.

6. TOWING OF VEHICLE.

a. **Towing To Start Vehicle.** Attach towing cable to towing hooks, also attach air line from towing truck to air line of truck to be towed, if possible. Place front axle declutch lever (fig. 3) in "OUT" position (fig. 4), and move transfer case shift lever to "HIGH" position (fig. 4). Shift main transmission gearshift lever to the No. 5 or "OVERDRIVE" position (fig. 4). Pull out choke and throttle into same position as for starting, and turn ignition switch to "ON" position. Release propeller shaft brake lever and depress clutch pedal. Engage clutch by releasing clutch pedal slowly when towing speed is reached. When engine starts, disengage clutch, and adjust controls until engine runs smoothly. If necessary to stop vehicle before engine starts and air is not available from towing vehicle, use propeller shaft brake with extreme care.

b. **Towing Disabled Vehicle.** Check tires for proper inflation to make towing easier (par. 135). Attach towing cable to towing hooks. Connect air supply from towing vehicle, if any, to trailer connections behind front bumper of vehicle to be towed. Move the front axle declutch lever to the "OUT" position (fig. 4), and place main transmission gearshift lever in neutral position (fig. 4). Push propeller shaft brake lever all the way down to the released position. If air supply is not connected, this brake provides the only possible means for stopping. **CAUTION:** Be careful in using propeller shaft brake

OPERATION UNDER UNUSUAL CONDITIONS

because it is extremely severe. If necessary to hoist front end of truck attach lifting tackle to bumper, using care to avoid crushing air tubing. Use necessary blocking between tow truck and bumper to prevent vehicle from running into tow truck. If necessary to hoist rear of truck, wrap chain around the entire frame immediately in front of rear spring rear bracket, making sure to get chain between spring and frame so that frame will carry the load. Attach necessary blocking between tow truck and rear frame rail to prevent collision. Straighten front wheels, and clamp the steering wheel to prevent turning.

Section IV
OPERATION UNDER UNUSUAL CONDITIONS**7. COLD WEATHER OPERATION.**

a. Purpose. Operation of automotive equipment at sub-zero temperatures presents problems that demand special precautions and extra careful servicing from both operation and maintenance personnel, if poor performance and total functional failure are to be avoided.

b. Gasoline. Winter grade of gasoline is designed to reduce cold weather starting difficulties; therefore the winter grade fuel should be used in cold weather operation.

c. Storage and Handling of Gasoline. Due to condensation of moisture from the air, water will accumulate in tanks, drums, and containers. At low temperatures, this water will form ice crystals that will clog fuel lines and carburetor jets unless the following precautions are taken:

(1) Strain the fuel through filter paper, or any other type of strainer that will prevent the passage of water. *CAUTION: Gasoline flowing over a surface generates static electricity that will result in a spark, unless means are provided to ground the electricity. Always provide a metallic contact between the container and the tank, to assure an effective ground.*

(2) Keep tank full, if possible. The more fuel there is in the tank, the smaller the volume of air will be from which moisture can be condensed.

(3) Add 1/2 pint of denatured alcohol, Grade 3, to the fuel tank each time it is filled. This will reduce the hazard of ice formation in the fuel.

(4) Be sure that all containers are thoroughly clean and free from rust before storing fuel in them.

(5) If possible, after filling or moving a container, allow the fuel to settle before filling fuel tank from it.

4. 10 5-TON 4x4 TRACTOR TRUCK (AUTOCAR MODEL U-7144T)

(6) Keep all openings of containers tight to prevent snow, ice, dirt, and other foreign matter from entering.

(7) Wipe all snow or ice from dispensing equipment and from around fuel tank filler cap before removing cap to refuel vehicle.

d. Lubrication.**(1) TRANSMISSION AND DIFFERENTIAL.**

(a) Universal gear lubricant, SAE 80, where specified on figures 5 and 6 or War Department Lubrication Guide No. 502, is suitable for temperatures as low as -20° F. If consistent temperature below 0° F is anticipated, drain the gear cases while warm, and refill with Grade 75 universal gear lubricant, which is suitable for operation at all temperatures below 0° F. If Grade 75 universal gear lubricant is not available, SAE 80 universal gear lubricant diluted with the fuel used by the engine, in the proportion of one part fuel to six parts universal gear lubricant, may be used. Dilute make-up oil in the same proportion before it is added to gear cases.

(b) After engine has been warmed up, engage clutch and maintain engine speed at fast idle for 5 minutes, or until gears can be engaged. Put transmission in low (first) gear, and drive vehicle for 100 yards, being careful not to stall the engine. This will heat gear lubricants to the point where normal operation can be expected.

(2) CHASSIS POINTS. Lubricate chassis points with general purpose grease, No. 0.

(3) STEERING GEAR HOUSING. Drain housing, if possible, or use suction gun to remove as much lubricant as possible. Refill with universal gear lubricant, Grade 75, or, if not available, SAE 80 universal gear lubricant diluted with fuel used in the engine, in the proportion of one part fuel to six parts SAE 80 universal gear lubricant. Dilute make-up oil in the same proportion before it is added to the housing.

(4) OILCAN POINTS. For oilcan points where engine oil is prescribed for above 0° F, use light lubricating preservative oil.

(5) PRECAUTIONS.

(a) Keep crankcase oil fluid by one of the following methods, listed in order of preference:

1. Keep vehicle in a heated enclosure when not in use.

2. After stopping engine, drain crankcase oil while still hot. Place warning tag in a conspicuous place in the cab to indicate crankcase is empty. Store oil in a warm place if possible; otherwise, heat oil before reinstalling.

3. Cover entire cab and engine section with tarpaulin. Place fire pots under tarpaulin about 3 hours before engine is to be started. A Primus, Van Praag, or other type blowtorch, and ordinary kerosene

OPERATION UNDER UNUSUAL CONDITIONS

lanterns may be used. **CAUTION:** *Be careful in applying flame directly to oil pan.*

4. Do not move the vehicle from a warm place into subzero temperature, unless necessary.

5. Park vehicle without setting propeller shaft brake to avoid brake freezing. Block wheels to prevent rolling of vehicle, and keep a blowtorch handy to thaw frozen propeller shaft or service brakes.

6. Inspect vehicle frequently for broken screws, bolts, or other metal parts, and for loosened nuts.

7. Dilute crankcase oil with gasoline, or with Diesel fuel in an emergency. Turn engine over several times to mix oil and diluent. After 4 or more hours of operation, redilute oil if vehicle is to be left standing unprotected for 3 or more hours. Use diluent for both original dilution and redilution as follows:

Temperature	Diluent	Quantity
0 F to -20 F	Gasoline	½ qt to each 4 ½ qt of engine oil
0 F to -20 F	Diesel fuel	½ qt to each 3 ½ qt of engine oil
Below -20 F	Gasoline	1 qt to each 5 qt of engine oil
Below -20 F	Diesel fuel	1 qt to each 4 qt of engine oil

NOTE: *Presence of diluent increases engine oil consumption. Check oil level frequently.*

c. Protection of Cooling Systems.

(1) **USE ANTIFREEZE COMPOUND.** Protect the system with antifreeze compound (ethylene-glycol type) for operation below +32° F. The following instructions apply to use of new antifreeze compound.

(2) **CLEAN COOLING SYSTEM.** Before adding antifreeze compound, clean the cooling system, and completely free it from rust. If the cooling system has been cleaned recently, it may be necessary only to drain, refill with clean water, and again drain. Otherwise clean the system with cleaning compound.

(3) **REPAIR LEAKS.** Inspect all hose and replace if deteriorated. Inspect all hose clamps, plugs, and pet cocks, and tighten if necessary. Repair all radiator leaks before adding antifreeze compound. Correct all leakage of exhaust gas or air into the cooling system.

(4) **ADD ANTIFREEZE COMPOUND.** When the cooling system is clean and tight, fill the system with water to about one-third capacity. Then add antifreeze compound, using the proportion of antifreeze compound to the cooling system capacity indicated below. Protect

4- TO 5-TON 4 x 4 TRACTOR TRUCK (AUTOCAR MODEL U-7144T)

the system to at least 10° F below the lowest temperature expected to be experienced during the winter season.

**ANTIFREEZE COMPOUND CHART
(FOR 40-QUART CAPACITY COOLING SYSTEM)**

Temperature	Antifreeze Compound (Ethylene-glycol Type)
-30 F	5 qt
-20 F	7 ½ qt
-10 F	10 qt
0 F	12 ½ qt
-10 F	15 qt
-20 F	17 ½ qt
-30 F	20 qt
-40 F	22 ½ qt
-50 F	22 ½ qt
-60 F	25 qt
-70 F	25 qt

(5) **WARM THE ENGINE.** After adding antifreeze compound, fill with water to slightly below the filler neck; then start and warm the engine to normal operating temperature.

(6) **TEST STRENGTH OF SOLUTION.** Stop the engine and check the solution with a hydrometer, adding antifreeze compound if required.

(7) **INSPECT WEEKLY.** In service, inspect the coolant weekly for strength and color. If rusty, drain and clean cooling system thoroughly, and add new solution of the required strength.

(8) **PRECAUTIONS.**

(a) Antifreeze compound is the only antifreeze material authorized for ordnance material.

(b) It is essential that antifreeze solutions be kept clean. Use only containers and water that are free from dirt, rust, and oil.

(c) Use an accurate hydrometer. To test a hydrometer, use one part antifreeze compound to two parts water. This solution will produce a hydrometer reading of 0° F.

(d) Do not spill antifreeze compound on painted surfaces.

f. **Electrical Systems.**

(1) **GENERATOR AND CRANKING MOTOR.** Check the brushes, commutators, and bearings. See that the commutators are clean. The large surges of current which occur when starting a cold engine require good contact between brushes and commutators.

OPERATION UNDER UNUSUAL CONDITIONS

(2) **WIRING.** Check clean, and tighten all connections, especially the battery terminals. Be sure that no short circuits are present.

(3) **COIL.** Check coil for proper functioning by noting quality of spark.

(4) **DISTRIBUTOR.** Clean thoroughly, and clean or replace points. Check the points frequently. In cold weather, slightly pitted points may prevent engine from starting.

(5) **SPARK PLUGS.** Clean and adjust spark plugs or replace, if necessary. If it is difficult to make the engine fire, reduce the gap to 0.005 inch less than that recommended for normal operation (par. 83 c (2)). This will make ignition more effective at reduced voltages likely to prevail.

(6) **TIMING.** Check the timing carefully. Be sure that the spark is not unduly advanced nor retarded.

(7) **BATTERY.**

(a) The efficiency of batteries decreases sharply with decreasing temperatures, and becomes practically nil at -40° F. Do not try to start the engine with the battery when it has been chilled to temperatures below -30° F, until battery has been heated, or unless a warm slave battery is available. See that the battery is always fully charged, with the hydrometer reading between 1.275 and 1.300. A fully charged battery will not freeze at temperatures likely to be encountered even in Arctic climates, but a fully discharged battery will freeze and rupture at -5° F.

(b) Do not add water to a battery when it has been exposed to subzero temperatures unless the battery is to be charged immediately. If water is added and the battery not put on charge, the layer of water will stay at the top and freeze before it has a chance to mix with the acid.

(8) **LIGHTS.** Inspect the lights carefully. Check for short circuits and presence of moisture around sockets.

(9) **ICE.** Before every start, see that the spark plugs, wiring, or other electrical equipment are free from ice.

g. Starting and Operating Engine.

(1) **INSPECT CRANKING MOTOR MECHANISM.** Be sure that no heavy grease or dirt has been left on the cranking motor throw-out mechanism. Heavy grease or dirt is liable to keep the gears from being meshed, or cause them to remain in mesh after the engine starts running. The latter will ruin the cranking motor and necessitate repairs.

(2) **USE OF CHOKE.** A full choke is necessary to secure the rich air-fuel mixture required for cold weather starting. Check the butter-

THE ARMY LIBRARY

WASHINGTON, D.C.

4- TO 5-TON 4 x 4 TRACTOR TRUCK (AUTOCAR MODEL U-7144T)

fly valve to see that it closes all the way and otherwise functions properly.

(3) **CARBURETOR AND FUEL PUMP.** The carburetor, which will give no appreciable trouble at normal temperatures, is liable not to operate satisfactorily at low temperatures. Be sure the fuel pump has no leaky valves or diaphragm, as this will prevent the fuel pump from delivering the amount of fuel required to start the engine at low temperatures when running speeds are reduced to between 30 and 60 revolutions per minute.

(4) **AIR CLEANER.** At temperatures below 0° F, do not use oil in air cleaners. The oil will congeal and prevent the easy flow of air. Wash screens in dry-cleaning solvent, dry, and replace. Ice and frost formations on the air cleaner screens can cause an abnormally high intake vacuum in the carburetor air horn hose, resulting in collapse.

(5) **FUEL SYSTEM.** Remove and clean sediment bowl, strainers, etc., daily. Also drain fuel tank sump daily to remove water and dirt.

h. Chassis.

(1) **BRAKE BANDS.** Brake bands, particularly on new vehicles, have a tendency to bind when they are very cold. Always have a blow torch handy to warm up these parts if they bind prior to moving, or attempting to move, the vehicle. Parking the vehicle with the brake released will eliminate most of the binding. Precaution must be taken, under these circumstances, to block the wheels or otherwise prevent movement of the vehicle.

(2) **EFFECT OF LOW TEMPERATURES ON METALS.** Inspect the vehicle frequently. Shock resistance of metals, or resistance against breaking, is greatly reduced at extremely low temperatures. Operation of vehicles on hard, frozen ground causes strain and jolting which will result in screws breaking, or nuts jarring loose.

(3) **SPEEDOMETER CABLE.** Disconnect the oil-lubricated speedometer cable at the drive end when operating the vehicle at temperatures of -30° F and below. The cable will often fail to work properly at these temperatures, and sometimes will break, due to the excessive drag caused by the high viscosity of the oil with which it is lubricated.

B. HOT WEATHER OPERATION.

a. **General.** Operation of these vehicles in high temperatures requires regular maintenance of cooling units, lubrication-filtering devices, and air cleaners. In extremely high temperatures, water-saving devices such as surge or overflow tanks should be employed. Avoid the continuous use of low gear ratios whenever possible. Make frequent inspections and servicing of air cleaners, fuel filter, and oil filter if side panels are removed during operation in dusty areas. Watch the temperature and oil gauges constantly. Check and replenish oil and

OPERATION UNDER UNUSUAL CONDITIONS

water frequently. **CAUTION:** *Inspect vehicle frequently for broken screws, bolts, or other metal parts, and for loosened nuts.*

h. Cooling System Maintenance.

(1) **COOLING LIQUID.** Formation of scale and rust in cooling system occurs more often during operation in extremely high temperatures; therefore rust preventives should always be added to the cooling liquids. Use only clean water. Avoid the use of water that contains alkali or other substances which may cause scale and rust formations.

(2) **COOLING SYSTEM.** Thoroughly clean and flush the cooling system at frequent intervals when operating in extremely high temperatures.

(3) **FAN BELT AND WATER PUMP.** Inspect fan belt at regular intervals and adjust if necessary (par. 75). Water pump must be kept in good operating condition.

(4) **THERMOSTAT.** Check operation of thermostat (par. 76). Thermostat must open at calibrated temperature to prevent overheating of cooling liquid.

(5) **HOSE CONNECTIONS.** Check hose connections frequently for leaks.

c. Hot, Dry Climates.

(1) Keep cooling system full of recommended coolant and maintain proper level of correct grade of lubricating oil in lubricating system. Check engine temperature frequently, and if temperature rises to 212° F, stop engine and inspect cooling system. Flush cooling system if necessary; look for sand in radiator fins; blow out with compressed air, if available.

(2) Under desert conditions, check oil filter, carburetor, air cleaner, and air compressor air filter every few hours, and service as necessary.

(3) Under sandy conditions, use lubricants sparingly and clean all sand from fittings before lubricating.

(4) Avoid touching machined surfaces when making repairs.

(5) Do not park vehicle in sun for long periods, because this shortens life of tires. If possible, place vehicle under cover to protect it from sand and dust. Cover inactive vehicles with tarpaulins if no suitable building is available.

d. Hot, Damp Climates.

(1) Keep cooling system clean and filled with clean, fresh (not salt) water. Use soft water when possible. Note engine temperature as registered by temperature gage frequently. Stop vehicle immediately if temperature of engine reaches 212° F.

(2) Protect exterior surfaces from atmosphere by renewing paint on all painted surfaces, and keeping a film of light engine oil on unfinished exterior metal surfaces.

4. TO 5-TON 4 x 4 TRACTOR TRUCK (AUTOCAR MODEL U-7144T)

(3) Flush metal surfaces which have been exposed to salt water with fresh water, and apply a film of light engine oil to unfinished metal parts.

(4) Make frequent inspections of stored vehicles. Remove corrosion from exterior surfaces with flint paper 2/0 (from machined surfaces with crocus cloth), and apply a protective coating of paint, oil, or rust-preventive compound.

c. Battery.

(1) **WATER LEVEL.** In torrid zones, cell water level should be checked daily and replenished if necessary with pure distilled water. If this is not available, any water fit to drink may be used. However, continuous use of water with high mineral content will eventually cause damage to battery and should be avoided.

(2) **SPECIFIC GRAVITY.** Batteries operating in torrid climates should have a weaker electrolyte than for temperate climates. Instead of 1.300 gravity, the electrolyte should be adjusted to around 1.210 to 1.230 for a fully charged battery. This will prolong the life of the negative plates and separators. Under this condition battery should be recharged at about 1.160. Where freezing conditions do not prevail, there is no danger with gravities from 1.230 to 1.075.

(3) **SELF-DISCHARGE.** A battery will self-discharge at a greater rate at high temperatures if standing for long periods. This must be taken into consideration when operating in torrid zones. If necessary to park for several days, remove battery and store in a cool place.

9. OPERATION IN MUD, SNOW, ICE, SAND, AND FLOOD.

a. Mud. Install tire chains on both rear wheels, and select low enough gear ratio to move vehicle steadily without putting undue driving strain on engine and axles.

b. Snow and Ice. Skidding is the general hazard encountered in these conditions. Install chains, and select the proper gear ratio to move the vehicle steadily, without imposing undue strain on engine and axle. When skidding occurs, turn the front wheels in the same direction that the rear end is skidding. Decelerate the engine, and apply brakes very gradually until vehicle is under control. Proceed with caution. Remove chains as soon as their use is no longer necessary.

c. Sand. The main objective when driving in sand is to avoid the possibility of spinning the driving wheels. If possible, lay an improvised track with planks or brush in order to prevent the wheels coming in contact with the loose footing. Do not let the motor labor. Reverse and go forward several times if necessary, until a solid road bed is reached.

d. Flood. Know the fording depth of this vehicle, and do not exceed its known limits. Reduce the vehicle speed to 4 miles per hour

FIRST ECHELON PREVENTIVE MAINTENANCE SERVICES

and proceed with caution. Exercise care to avoid water damage to electrical and driving systems. Lubricated parts which have been affected by mud and water must be serviced at earliest opportunity.

c. **Precautions.** Do not allow mud, snow, or ice to cake on wheels, slack adjusters, steering knuckles, and steering arms, or to gather on the air system safety valve, oil filter, or air filter openings. Inspect and clean mud, snow, or ice off radiator core, fan, and fan belts. Keep mud, snow, ice, and moisture off all electrical connections.

10. DECONTAMINATION.

a. **Poisonous Gas.** Removing and destroying dangerous chemical agents encountered when operating in affected areas is known as decontamination and is covered by instructions contained in FM 17-59.

Section V

FIRST ECHELON PREVENTIVE MAINTENANCE SERVICES

11. PURPOSE.

a. To insure mechanical efficiency, it is necessary that the vehicle be systematically inspected at intervals each day it is operated as well as weekly, so that defects may be discovered and corrected before they result in serious damage or failure. Certain scheduled maintenance services will be performed at these designated intervals. The services set forth in this section are those performed by driver or crew before-operation, during-operation, at-halt, and after-operation, and weekly.

b. Driver preventive maintenance services are listed on the back of "Driver's Trip Ticket and Preventive Maintenance Service Record" W.D. Form No. 48 to cover vehicles of all types and models. Items peculiar to specific vehicles but not listed on W.D. Form No. 48 are covered in manual procedures under the items with which they are related. Certain items listed on the form that do not pertain to the vehicle involved are eliminated from the procedure as written into the manual. Every organization must thoroughly school each driver in performing the maintenance procedures set forth in manuals whether they are listed specifically on W.D. Form No. 48 or not.

c. The items listed on W.D. Form No. 48 that apply to this vehicle are expanded in this manual to provide specific procedures for accomplishment of the inspections and services. These services are arranged to facilitate inspection and conserve the time of the driver, and are not necessarily in the same numerical order as shown on W.D. Form No. 48. The item numbers, however, are identical with those shown on that form.

4. TO 5-TON 4 x 4 TRACTOR TRUCK (AUTOCAR MODEL U-7144T)

d. The general inspection of each item applies also to any supporting member or connection, and generally includes a check to see whether the item is in good condition, correctly assembled, secure, or excessively worn.

e. The inspection for "good condition" is usually an external visual inspection to determine whether the unit is damaged beyond safe or serviceable limits. The term "good condition" is explained further by the following terms: not bent or twisted, not chafed or burned, not broken or cracked, not bare or frayed, not dented or collapsed, not torn or cut.

f. The inspection of a unit to see that it is "correctly assembled" is usually an external visual inspection to see whether it is in its normal assembled position in the vehicle.

g. The inspection of a unit to determine if it is "secure" is usually an external visual examination, a wrench, hand-feel, or a pry-bar check for looseness. Such an inspection should include any brackets, lock washers, lock nuts, lock wires, or cotter pins used in assembly.

h. "Excessively worn" will be understood to mean worn close to, or beyond serviceable limits, and likely to result in a failure if not replaced before the next scheduled inspection.

i. Any defects or unsatisfactory operating characteristics beyond the scope of first echelon to correct must be reported at the earliest opportunity to the designated individual in authority.

12. BEFORE-OPERATION SERVICE.

a. This inspection schedule is designed primarily as a check to see that the vehicle has not been damaged, tampered with, or sabotaged since the After-operation Service was performed. Various combat conditions may have rendered the vehicle unsafe for operation and it is the duty of the driver to determine whether or not the vehicle is in condition to carry out any mission to which it is assigned. This operation will not be entirely omitted, even in extreme tactical situations.

b. **Procedures.** Before-operation Service consists of inspecting items listed below according to the procedure described, and correcting or reporting any deficiencies. Upon completion of the service, results should be reported promptly to the designated individual in authority.

(1) **ITEM 1. TAMPERING AND DAMAGE.** Look for any injury to vehicle, its accessories, or equipment, caused by tampering or sabotage, collision, falling debris, or shell fire since parking. Look in engine compartment for evidence of above conditions, and for loosened or damaged engine accessories or drive belts, loose fuel, oil or coolant lines, or disconnected control linkage.

FIRST ECHELON PREVENTIVE MAINTENANCE SERVICES

(2) **ITEM 2, FIRE EXTINGUISHER.** See that extinguisher is securely mounted and not damaged. Look for evidence of opened operating valve or leakage.

(3) **ITEM 3, FUEL, ENGINE OIL, AND COOLANT SUPPLY.** Check amount of fuel in tank. Check crankcase oil level on dip stick. Check coolant level. Add fuel necessary to complete mission or to operate vehicle to next scheduled fueling point. Add engine oil and coolant as needed to bring to correct level. **NOTE:** *Any appreciable drop in levels since After-operation Service should be investigated, and cause corrected or reported to designated authority.* During freezing weather when antifreeze solution is in use, if any appreciable addition of water is needed, antifreeze value should be tested by second echelon and added if necessary. Be sure spare fuel, oil, and water cans are full and securely mounted.

(4) **ITEM 4, ACCESSORIES AND DRIVES.** Examine units, such as carburetor, generator, cranking motor, air compressor, fan, and air cleaners for looseness, damage, or leaks. Be sure drive belts are in good condition and that adjustment is satisfactory. Belts should have 1/2- to 3/4-inch finger-pressure deflection.

(5) **ITEM 5, AIR BRAKE TANKS.** Check the air brake reservoir tanks to see that they are secure and undamaged, and that all air line connections are tight. Also be sure that water (condensation) has been drained from the tanks and that drain cocks are closed.

(6) **ITEM 6, LEAKS, GENERAL.** Inspect ground and also under the vehicle and within engine compartment for indications of fuel, engine oil, coolant, and gear oil leaks. Pay particular attention to fuel tanks and lines, crankcase and oil filters, radiator, water pump, water lines and connections, and all gear cases. Trace any leaks found to their source, and correct or report them to designated authority.

(7) **ITEM 7, ENGINE WARM-UP.** Start engine and note any tendency toward hard starting. Observe action of cranking motor, particularly if it has adequate cranking speed and engages and disengages without unusual noise when in operation. Set hand throttle so that engine idles at 450 to 600 revolutions per minute, and during warm-up, proceed with following Before-operation Services. **NOTE:** *If oil pressure is not evident in 30 seconds, stop engine and investigate.*

(8) **ITEM 8, CHOKE.** As engine is being started, check operation of choke. As engine warms up, reset choke as required for engine to run smoothly and to prevent overchoking and oil dilution.

(9) **ITEM 9, INSTRUMENTS.**

(a) **Oil Gage.** Pressure at normal engine operating speed must be 30 to 50 pounds, and the minimum at idling speed must be 5 pounds.

(b) **Ammeters.** Regular ammeter should show positive (+) charge with engine at fast idle, and at slower speeds with lights on may show

4. TO 5-TON 4 x 4 TRACTOR TRUCK (AUTOCAR MODEL U-7144T)

on negative (-) side. "B" ammeter indicates that second battery or "B" battery is charging or discharging. High charge readings may be indicated until generator restores to batteries current used in starting engine.

(c) *Engine Temperature Gage.* Reading should increase gradually during warm-up period to normal operating range 157°F. to 183°F. Maximum safe temperature is 200°F. NOTE: Do not move vehicle until temperature reaches minimum operating range of 135°F.

(d) *Vacuumeter.* After engine has reached operating temperature, reading should be in "ideal" range.

(e) *Tachometer.* White pointer should indicate actual engine revolutions per minute at any given time engine is running. Read hand indicates, and remains at highest engine revolutions per minute reached. It should not exceed 2,400 revolutions per minute.

(f) *Air Pressure Gage.* Gage should register 60 pounds before moving vehicle. Maximum governed pressure is 105 pounds.

(g) *Fuel Gage.* Inspect gage to see that it registers the approximate amount of fuel in tank. Ordinarily tank will be filled after operation and gage should register "FULL."

(10) **ITEM 10, HORN AND WINDSHIELD WIPERS.** If tactical situation permits, test horn for proper operation and tone. Test wipers to see that they operate, and observe whether the blades contact glass evenly and arms travel through full stroke. Inspect for damage.

(11) **ITEM 11, GLASS AND REAR VISION MIRROR.** Clean all glass and inspect for damage. Air rear vision mirror properly and see that it is secure.

(12) **ITEM 12, LAMPS (LIGHTS) AND REFLECTORS.** See that all lights and warning reflectors are clean. Examine them for looseness or damage. If tactical situation permits, open and close switches, and observe if lights respond properly. Include stop and blackout lights.

(13) **ITEM 13, WHEEL AND FLANGE NUTS.** See that all wheel mounting and axle flange nuts are present and secure.

(14) **ITEM 14, TIRES.** Maximum tire pressure should be 65 pounds (cool). Inspect tires for damage, and remove any embedded objects from treads, carcass, or between duals.

(15) **ITEM 15, SPRINGS AND SUSPENSIONS.** Inspect springs and shock absorbers to see that they are secure and not damaged, and that all assembly and mounting nuts and screws are tight. Examine shock absorbers for leaks.

(16) **ITEM 16, STEERING LINKAGE.** Inspect gear case and all rods and friction points for looseness, damage, or excessive lubricant leaks.

(17) **ITEM 17, FENDERS AND BUMPERS.** Inspect fenders and bumpers for looseness or damage.

FIRST ECHELON PREVENTIVE MAINTENANCE SERVICES

(18) **ITEM 18, TOWING CONNECTIONS.** Inspect all connections for looseness or damage. Examine jangle to be sure it operates freely and locks securely. See that fifth wheel is secure and not damaged, that lever and kingpin connection works properly, and that it will lock securely.

(19) **ITEM 19, BODY AND TARPAULIN.** Inspect cab and top tarpaulin for damage. See that doors and latches operate properly, and that floor plates and engine cover are secure.

(20) **ITEM 20, DECONTAMINATOR.** Be sure decontaminator is present, fully charged, and secure.

(21) **ITEM 21, TOOLS AND EQUIPMENT.** Be sure all items are present, serviceable, and properly mounted or stowed.

(22) **ITEM 22, ENGINE OPERATION.** Before vehicle is put in motion, be sure engine has reached operating temperature and idles smoothly. Accelerate and decelerate and listen for any unusual vibration or noise. Note any unsatisfactory operating characteristics or excessive exhaust smoke.

(23) **ITEM 23, DRIVER'S PERMIT AND FORM NO. 26.** Driver must have his operator's permit on his person. Check to see that Standard Form No. 26 Driver's Report-Accident, Motor Transportation, Operator's Manual, Lubrication Guide, and W.D., AGO Form No. 478 are present in vehicle, legible, and properly stowed.

(24) **ITEM 25, DURING-OPERATION CHECK.** The During-operation Services and observations start immediately as the vehicle is put in motion. Detailed description follows.

13. DURING-OPERATION SERVICE.

a. While vehicle is in motion, listen for any such sounds as rattles, knocks, squeals, or hums that may indicate trouble. Look for indications of trouble in cooling system and smoke from any part of the vehicle. Be on the alert to detect any odor of overheated components or units such as generator, brakes, or clutch, fuel vapor from a leak in fuel system, exhaust gas, or other signs of trouble. Each time the brakes are used, gears shifted, or vehicle turned, consider this a test and notice any unsatisfactory or unusual performance. Watch the instruments constantly. Notice promptly any unusual instrument indications that may signify possible trouble in the system to which the instrument applies.

b. **Procedures.** During-operation Services consist of observing items listed below according to the procedures following the instructions in each item, and investigating any indications of serious trouble. Notice minor deficiencies to be corrected or reported at earliest opportunity, usually next scheduled halt.

4- TO 5-TON 4 x 4 TRACTOR TRUCK (AUTOCAR MODEL U-7144T)

(1) **ITEM 27, FOOT AND HAND BRAKES.** Foot brakes should stop vehicle smoothly and effectively with normal pedal pressure, and return to off position immediately after foot pressure is released. If towed vehicle is connected, test hand-operated air application valve separately, and note if brake action on trailer is satisfactory. Hand brake should hold vehicle on a reasonable incline, leaving one-half ratchet travel in reserve, and should lock securely in applied position.

(2) **ITEM 28, CLUTCH.** Clutch should not grab, chatter, or squeal during engagement, or slip when fully engaged under load. Pedal should have a 1½-inch free travel before meeting resistance.

(3) **ITEM 29, TRANSMISSIONS.** Gears should shift smoothly and quietly, and not creep out of mesh during operation.

(4) **ITEM 30, TRANSFER.** Transfer unit range gears and declutching mechanism should shift easily and quietly and not creep out of mesh during operation.

(5) **ITEM 31, ENGINE AND CONTROLS.** The driver must be on the alert for deficiencies in engine performance, such as lack of usual power, misfiring or stalling, unusual noise or vibration, and any indications of overheating or excessive exhaust smoke. Observe if engine responds to all controls and if the controls are in proper adjustment, and not excessively loose or binding.

(6) **ITEM 32, INSTRUMENTS.** Observe readings of all instruments frequently during operation to be sure units to which they apply are functioning satisfactorily.

(a) *Oil Pressure Gage.* Gage should show normal operating pressure, 5 pounds minimum at idling, and 30 to 50 pounds at operating vehicle speeds.

(b) *Ammeters.* During operation, with all lights and accessories turned off, the main ammeter should indicate a positive (+) charge at operating speed or with fully charged batteries, and regulator unit cut-in may register zero. "B" ammeter should also show positive (+) or zero charge. Investigate or report excessive negative (-) readings to proper authority.

(c) *Engine Temperature Gage.* Gage should read 157° F. to 183° F. in normal operating range. Maximum safe temperature is 200° F.

(d) *Viscometer.* During operation, viscometer pointer should remain in "ideal" range. This range reading may indicate oil dilution. Heavy range reading may indicate oil contamination, such as presence of dirt or sludge. Abnormal readings should be investigated or reported to proper authority.

(e) *Air Pressure Gage.* Maximum reading should be 105 pounds, minimum 60 pounds.

FIRST ECHELON PREVENTIVE MAINTENANCE SERVICES

(f) *Tachometer.* White pointer should register actual engine revolutions per minute, and red pointer should not exceed maximum governed speed, 2400 revolutions per minute.

(g) *Speedometer.* Pointer should indicate actual vehicle speed, and odometer should register total accumulated mileage.

(h) *Fuel Gage.* Fuel gage should continue to register approximate amount of fuel in tank.

(7) **ITEM 33, STEERING GEAR.** Note any indication of looseness or binding, pulling to one side, wandering, shimmy, wheel tramp, or unusual noise.

(8) **ITEM 34, RUNNING GEAR.** Be on the alert for any unusual operating characteristics or noise from wheels, axles, or suspension units that might indicate looseness or damage, or under-inflated tires.

(9) **ITEM 35, BODY.** Note any noise or abnormal condition that might indicate shifting, loose top tarpaulin or curtains, loose or damaged doors, hardware, floor or inspection plates, or mounted body attachments.

14. AT-HALT SERVICE.

a. At-halt Services may be regarded as minimum maintenance procedures and should be performed under all tactical conditions even though more extensive maintenance services must be slighted or omitted altogether.

b. *Procedures.* At-halt Services consist of investigating any deficiencies noted during operation, inspecting items listed below according to the procedures following the items, and correcting any deficiencies found. Deficiencies not corrected should be reported promptly to the designated individual in authority.

(1) **ITEM 32, FUEL, OIL, AND WATER SUPPLY.** Check the fuel supply to see that it is adequate to operate the vehicle to the next refueling point. When refueling, use safety precautions for grounding static electricity, and allow space for expansion in filler neck. Filler cap vents must be open, pressure cap valves must be free, and caps must be replaced securely. Check the crankcase oil level and, if necessary, add oil to proper level. Remove radiator filler cap being careful of steam, especially if a pressure cap is used. Check coolant to see that it is at proper level, and replenish as necessary. Do not fill to overflowing but leave sufficient space for expansion. If engine is hot, fill slowly while engine is running at a fast idle.

(2) **ITEM 39, TEMPERATURES: HUBS, BRAKE DRUMS, TRANSFER, TRANSMISSION, AND AXLES.** Place hand cautiously on each brake drum and wheel hub to see if it is abnormally hot. Inspect transfer case, transmission, and axle housings for overheating, and note any excessive lubricant leaks.

4- TO 5-TON 4x4 TRACTOR TRUCK (AUTOCAR MODEL U-7144T)

(3) **ITEM 40, AXLE AND TRANSFER VENTS.** Wipe clean and inspect vents for damage or clogging. Vents must be kept open.

(4) **ITEM 41, PROPELLER SHAFTS.** Inspect all drive shafts and universal joints for looseness, damage, and excessive lubricant leaks. Remove any foreign matter wound around shafts or joints.

(5) **ITEM 42, SPRINGS AND SUSPENSIONS.** Inspect for broken or shafted spring leaves, damaged or loose U-bolts, eye bolts, shackles, rebound clips or shock absorber bodies and linkage, or excessive shock fluid leaks.

(6) **ITEM 43, STEERING LINKAGE.** Examine all steering control mechanism arms and linkage frictional joints for looseness or damage. Investigate any unusual condition noted during operation.

(7) **ITEM 44, WHEEL AND FLANGE NUTS.** See that all wheel mounting and axle flange nuts are present and secure.

(8) **ITEM 45, TIRES.** Inspect all tires for under-inflation or damage. Remove embedded objects in treads or carcasses and from between duals. See that spare tire is inflated and secure in carrier.

(9) **ITEM 46, LEAKS, GENERAL.** Look under vehicle and within engine compartment for indications of fuel, oil, or coolant leaks. Trace any leaks found to their source, and correct or report them to proper authority.

(10) **ITEM 47, ACCESSORIES AND BELTS.** Examine all accessible units for looseness or damage. Be sure generator, fan, and compressor drive belt tension is satisfactory.

(11) **ITEM 48, AIR CLEANER.** If operating under extremely dusty or sandy conditions, inspect air cleaner and breather cap to see that they are in condition to deliver clean air properly. Service as necessary.

(12) **ITEM 49, FENDERS AND BUMPER.** Inspect front bumper, fenders, and rear splash guards for looseness or damage.

(13) **ITEM 50, TOWING CONNECTIONS.** Inspect all connections for looseness or damage. Be sure locking devices are secure, and that trailer brake air hose is supported so as not to chafe on other vehicle parts.

(14) **ITEM 51, BODY AND TARPULIN.** Inspect for damage, or any indications of looseness or shifting of cab.

(15) **ITEM 52, GLASS.** Clean windshield, mirror, light, and warning reflector glass, and inspect for damage.

15. AFTER-OPERATION AND WEEKLY SERVICE.

a. After-operation Service is particularly important, because at this time, the driver inspects his vehicle to detect any deficiencies that may have developed and corrects those he is permitted to handle. He should report promptly to the designated individual in authority the results

FIRST ECHELON PREVENTIVE MAINTENANCE SERVICES

of his inspection. If this schedule is performed thoroughly, the vehicle should be ready to roll again on a moment's notice. The Before-operation Service, with a few exceptions, is necessary only to ascertain whether the vehicle is in the same condition in which it was left upon completion of the After-operation Service. The After-operation Service should never be entirely omitted even in extreme tactical situations, but may be reduced to the bare fundamental services outlined for the At-halt Service if necessary.

b. **Procedures.** When performing the After-operation Service, the driver must remember and consider any irregularities noticed during the day in the Before-operation, During-operation, and At-halt Services. The After-operation Service consists of inspecting and servicing the following items. (Those items of the After-operation service that are marked by an asterisk (*) require additional weekly services, the procedures for which are indicated in subparagraph (b) of each applicable item.)

(1) **ITEM 55, ENGINE OPERATION.** Test engine for satisfactory performance and smooth idle. Accelerate and decelerate engine, and note any tendency to miss or backfire. Listen for any unusual noise or vibration that may indicate worn or inadequately lubricated parts, loose mountings, incorrect fuel mixture, or faulty ignition. Note any unusual exhaust smoke. Investigate and correct, or report any deficiencies noted during operation to the proper authority.

(2) **ITEM 56, INSTRUMENTS.** Check all pertinent instruments to be sure all are operating properly and continue to register or indicate correct performance of the units to which they apply. Stop engine, first allowing it to cool off for 4 to 5 minutes if it is at or beyond normal temperature.

(3) **ITEM 54, FUEL, OIL, AND WATER SUPPLY.** Fill fuel tanks. (See if fuel gage indicates full.) Check crankcase oil, and add as necessary to bring to correct level. Check coolant level, and add as necessary to bring to correct level. **NOTE: Do not overfill fuel tanks or radiator. Allow room for expansion.** In freezing weather, if any appreciable amount of coolant is necessary, have antifreeze value checked, and add enough to protect cooling system against freezing. Do not add coolant while engine is too hot. Fill all spare fuel, oil, and water cans if supply has been used.

(4) **ITEM 57, HORN AND WINDSHIELD WIPERS.** Inspect these items to see if they are secure and not damaged. If tactical conditions permit, test horn for proper operation and tone.

(5) **ITEM 58, GLASS AND REAR VISION MIRROR.** Clean and inspect for damage, and be sure that mountings are secure.

(6) **ITEM 59, LAMPS (LIGHTS) AND REFLECTORS.** Inspect for looseness or damage. If tactical situation permits, test all lights and switches for proper operation. Clean all lenses.

4- TO 5-TON 4 x 4 TRACTOR TRUCK (AUTOCAR MODEL U-7144T)

(7) **ITEM 60. FIRE EXTINGUISHER.** Inspect extinguisher for looseness or damage and full charge. If extinguisher has been in use or valves opened, report for refill or exchange.

(8) **ITEM 61. DECONTAMINATOR.** Inspect decontaminator for looseness or damage and full charge. If used, report for refill or exchange.

(9) **ITEM 62. *BATTERIES.**

(a) Inspect batteries to see that they are clean, secure, and not leaking or damaged. See that cell caps are fingertight.

(b) *Weekly.* Clean dirt from top of batteries. If terminal connections or posts are corroded, clean them thoroughly and apply fresh, thin coating of grease. Tighten terminal bolts if loose. Remove vent caps and check level of electrolyte. Add water if required, taking precautions so that battery will not be damaged during freezing temperatures. Battery should be secure, not bulging or cracked, or leaking electrolyte; battery carrier should be secure, clean, free of rust, and well painted. If mountings are loose, tighten them cautiously so as not to damage the battery case. Report any defects to proper authority.

(10) **ITEM 63. ACCESSORIES AND BELTS.** Inspect units such as carburetor, generator, cranking motor, fan, water pump, compressor, distributor, regulator unit, and oil filters, for looseness, damage, or leaks. Check condition and adjustment of drive belts. Belts should have $\frac{1}{2}$ - to $\frac{3}{4}$ -inch finger-pressure deflection. Investigate and correct, or report to the proper authority any deficiencies of accessory units or drives noted during operation.

(11) **ITEM 64. ELECTRICAL WIRING.** Inspect all ignition wiring for looseness or damage, wipe off excessive grease or moisture. Also make an inspection of all accessible low voltage wiring and connections for looseness or damage. Be sure all wiring is supported, so as not to chafe against other vehicle parts.

(12) **ITEM 65. *AIR CLEANER AND BREATHER CAPS.**

(a) Inspect for looseness or damage. Examine oil in reservoirs for correct level and excessive dirt. When operating in sandy or dusty conditions, clean and service air cleaner and breather cap as often as necessary.

(b) *Weekly.* Remove air cleaner and breather reservoirs and elements. Wash in dry-cleaning solvent, refill reservoirs with clean oil, and reinstall securely. Be sure all gaskets seal properly and that joints and connections are secure.

(13) **ITEM 66. *FUEL FILTER.**

(a) Inspect filter for looseness, damage, and fuel leaks.

FIRST ECHELON PREVENTIVE MAINTENANCE SERVICES

(b) *Weekly.* Remove sediment bowl drain plug and drain off all accumulated dirt and water. If draining of fuel pump sediment bowl shows excessive dirt or water, remove and clean element in dry-cleaning solvent.

(14) **ITEM 67. ENGINE CONTROLS.** Examine all engine operating control linkage for looseness, damage, excessive wear, and adequate lubrication.

(15) **ITEM 68. TIRES.**

(a) Examine all tires, including spares, for damage and excessive wear. Remove all embedded foreign matter, such as nails, glass, or stones, from treads and carcasses and from between duals. Check for low pressures, proper position of valve stem, and presence of valve caps. Inflate to correct pressure as needed; maximum is 65 pounds, cool.

(b) *Weekly.* Replace badly worn or otherwise unserviceable tires. Serviceable tires which show abnormal wear should be re-located to other wheels to even wear. Apparent mechanical deficiencies causing such wear should be reported for attention by higher echelon.

(16) **ITEM 69. SPRINGS AND SUSPENSIONS.** Inspect for looseness or damage, abnormal spring sag, shifted spring leaves, and shock absorber leakage. Investigate any noise or unusual condition noted during operation.

(17) **ITEM 70. STEERING LINKAGE.** Inspect linkage for looseness or damage. Examine steering gear case and frictional joints for excessive lubricant leakage or lack of lubrication. Investigate any unusual operating condition noted during operation.

(18) **ITEM 71. PROPELLER SHAFTS.** Inspect all drive shafts and universal joints for looseness or damage and excessive oil leaks. Remove any foreign material wound around shafts or joints.

(19) **ITEM 72. AXLE AND TRANSFER VENTS.**

(a) Make sure that all axle housing and transfer case vents are present, in good condition, and clean. Inspect for indications of lubricant leakage from vents.

(b) *Weekly.* Remove vents, clean out passages, and reinstall securely.

(20) **ITEM 73. LEAKS, GENERAL.** Look in engine compartment and under vehicle for indications of fuel, engine oil, coolant, or gear oil leaks.

(21) **ITEM 74. GEAR OIL LEVELS.** Check gear oil levels in differentials, transfer case, transmission, and steering gear housing, and report to proper authority if low. Correct levels are from lower edge of filler hole to one-half inch below when cool.

4. TO 5-TON 4 x 4 TRACTOR TRUCK (AUTOCAR MODEL U-7144T)

(22) ITEM 75. *AIR BRAKE TANKS.

(a) Inspect tanks and lines for looseness or damage. Open reservoir drain cocks and drain off all accumulated condensation.

(b) *Weekly.* Tighten tank mountings and line connections. Clean air line rubber hose of all grease or oil.

(23) ITEM 76. FENDERS AND BUMPERS. Inspect front fenders, bumper, and rear splash guards for looseness or damage.

(24) ITEM 77. *TOWING CONNECTIONS.

(a) Inspect towing hooks, truck tractor fifth wheel (if used), or pintle hook and safety chains for looseness, excessive wear, or damage.

(b) *Weekly.* Lower trailer landing gear, if connected, and unhitch trailer. Clean contacting surfaces of fifth wheel plate and king-pin latch mechanism. Inspect them for wear and damage, and apply a fresh coating of clean grease. Rebitch the trailer, noticing whether the hand lever works easily. Also note whether the latching mechanism closes completely and latches securely.

(25) ITEM 78. BODY AND TARPAULIN. Inspect cab carefully for damage or loose parts. Examine top tarpaulin and side curtains for worn spots or other damage, and see that they are secure.

(26) ITEM 82. *TIGHTENING.

(a) Tighten any mounting or external assembly nuts or screws if necessary.

(b) *Weekly.* Tighten wheel mounting and axle flange nuts and cap screw, spring U-bolts, eye bolts, shackles and rebound clips. Also tighten universal joint companion flanges, engine mountings, transfer case mountings, steering arms, towing connections, or any other mounting or assembly nuts or screws if necessary.

(27) ITEM 83. *LUBRICATE AS NEEDED.

(a) Lubricate all items, such as shackles, hinges, latches, control linkage frictional joints, or any point where inspection has indicated oilcan or hand greasing is needed.

(b) *Weekly.* Lubricate all points of the vehicle indicated on the Lubrication Guide if it is necessary.

(28) ITEM 84. *CLEAN ENGINE AND VEHICLE.

(a) Clean dirt and grease or oil drippings from inside cab, from engine compartment, and exterior of engine. Wipe off excess dirt and grease from entire vehicle.

(b) *Weekly.* Wash vehicle when possible. If not possible, wipe off thoroughly. Inspect paint or camouflage pattern for rust or for bright spots which might cause light reflections. Make sure that vehicle markings are legible unless covered for tactical reasons. **CAUTION:** *If vehicle is driven into water for washing, be careful that water or dirt does not get into wheel bearings, gear cases or brakes, or on electrical units or wiring.*

LUBRICATION

(29) ITEM 85. "TOOLS AND EQUIPMENT.

(a) Check vehicle stowage and tool lists to see that all items are present. Inspect items to see that they are in good condition and properly mounted or stowed.

(b) *Weekly.* Clean all tools and equipment of rust or dirt, and apply preservative where necessary when possible. See that tools with cutting edges are sharp and properly protected. Make sure that all items are securely mounted or stowed. NOTE: When services are completed, be sure all inspection plates are replaced securely.

Section VI

LUBRICATION

16. LUBRICATION GUIDE.

a. War Department Lubrication Guide No. 502 (figs 5 and 6) prescribes lubrication maintenance for 4- to 5-ton 4 x 4 Tractor Truck (Autocar Model U-7144 T). The Guide is supplemented in this manual with localized views of important lubrication points (figs 7, 8, and 9).

b. A Lubrication Guide is placed on or is issued with each vehicle and is to be carried with it at all times. In the event the vehicle is received without a guide, the using arms shall immediately requisition a replacement from the Commanding Officer, Fort Wayne Ordnance Depot, Detroit 32, Michigan.

c. Lubrication instructions on the Guide are binding on all echelons of maintenance, and there shall be no deviations from these instructions.

d. Service intervals specified on the Guide are for normal operation conditions. Reduce these intervals under extreme conditions such as excessively high or low temperatures, prolonged periods of high speed, continued operation in sand or dust, immersion in water, or exposure to moisture, any one of which may quickly destroy the protective qualities of the lubricant and require servicing in order to prevent malfunctioning or damage to the materiel.

e. Lubricants are prescribed in the "Key" in accordance with three temperature ranges; above +32°F., +32°F. to 0°F., and below 0°F. Determine the time to change grades of lubricants by maintaining a close check on operation of the vehicle during the approach to change-over periods. Be particularly observant when starting the engine. Sluggish starting is an indication of thickened lubricants and the signal

4- TO 5-TON 4x4 TRACTOR TRUCK (AUTOCAR MODEL U-7144T)

WAR DEPARTMENT
ORDNANCE DEPARTMENT

LUBRICATION GUIDE

RA 502

TRUCK, TRACTOR, 4-5 TON, 4x4, C.O.E.
(AUTOCAR U-7144-T)

For model numbers, see RA 116

TABLE OF CAPACITIES AND DIMENSIONS TO BE USED

QUANT	CAPACITY (Approx.)	WEIGHT (Approx.)	TEMPERATURE
Engine	13 P	1375 lbs (618 kg)	30 to 120 F (0 to 49 C)
Transmission	4 P	400 lbs (181 kg)	30 to 120 F (0 to 49 C)
Transfer Case	4 P	400 lbs (181 kg)	30 to 120 F (0 to 49 C)
Final Drive	4 P	400 lbs (181 kg)	30 to 120 F (0 to 49 C)
Front Axle	4 P	400 lbs (181 kg)	30 to 120 F (0 to 49 C)
Rear Axle	4 P	400 lbs (181 kg)	30 to 120 F (0 to 49 C)

NOTE—See Service Bulletin for instructions at these points and intervals.

CAUTION—Use Service Bulletin for instructions at these points and intervals.

- A Spring Bed
- B Ring Lead
- C Steering Gear Housing
- D Steering Gear Housing
- E Drive Shaft
- F Drive Shaft
- G Drive Shaft
- H Drive Shaft
- I Drive Shaft
- J Drive Shaft
- K Drive Shaft
- L Drive Shaft
- M Drive Shaft
- N Drive Shaft
- O Drive Shaft
- P Drive Shaft
- Q Drive Shaft
- R Drive Shaft
- S Drive Shaft

GRADES:

- CG SAE 100 Motor Oil
- CG SAE 150 Motor Oil
- CG SAE 200 Motor Oil
- CG SAE 300 Motor Oil
- CG SAE 400 Motor Oil
- CG SAE 500 Motor Oil
- CG SAE 600 Motor Oil
- CG SAE 700 Motor Oil
- CG SAE 800 Motor Oil
- CG SAE 900 Motor Oil
- CG SAE 1000 Motor Oil
- CG SAE 1100 Motor Oil
- CG SAE 1200 Motor Oil
- CG SAE 1300 Motor Oil
- CG SAE 1400 Motor Oil
- CG SAE 1500 Motor Oil
- CG SAE 1600 Motor Oil
- CG SAE 1700 Motor Oil
- CG SAE 1800 Motor Oil
- CG SAE 1900 Motor Oil
- CG SAE 2000 Motor Oil
- CG SAE 2100 Motor Oil
- CG SAE 2200 Motor Oil
- CG SAE 2300 Motor Oil
- CG SAE 2400 Motor Oil
- CG SAE 2500 Motor Oil
- CG SAE 2600 Motor Oil
- CG SAE 2700 Motor Oil
- CG SAE 2800 Motor Oil
- CG SAE 2900 Motor Oil
- CG SAE 3000 Motor Oil
- CG SAE 3100 Motor Oil
- CG SAE 3200 Motor Oil
- CG SAE 3300 Motor Oil
- CG SAE 3400 Motor Oil
- CG SAE 3500 Motor Oil
- CG SAE 3600 Motor Oil
- CG SAE 3700 Motor Oil
- CG SAE 3800 Motor Oil
- CG SAE 3900 Motor Oil
- CG SAE 4000 Motor Oil
- CG SAE 4100 Motor Oil
- CG SAE 4200 Motor Oil
- CG SAE 4300 Motor Oil
- CG SAE 4400 Motor Oil
- CG SAE 4500 Motor Oil
- CG SAE 4600 Motor Oil
- CG SAE 4700 Motor Oil
- CG SAE 4800 Motor Oil
- CG SAE 4900 Motor Oil
- CG SAE 5000 Motor Oil
- CG SAE 5100 Motor Oil
- CG SAE 5200 Motor Oil
- CG SAE 5300 Motor Oil
- CG SAE 5400 Motor Oil
- CG SAE 5500 Motor Oil
- CG SAE 5600 Motor Oil
- CG SAE 5700 Motor Oil
- CG SAE 5800 Motor Oil
- CG SAE 5900 Motor Oil
- CG SAE 6000 Motor Oil
- CG SAE 6100 Motor Oil
- CG SAE 6200 Motor Oil
- CG SAE 6300 Motor Oil
- CG SAE 6400 Motor Oil
- CG SAE 6500 Motor Oil
- CG SAE 6600 Motor Oil
- CG SAE 6700 Motor Oil
- CG SAE 6800 Motor Oil
- CG SAE 6900 Motor Oil
- CG SAE 7000 Motor Oil
- CG SAE 7100 Motor Oil
- CG SAE 7200 Motor Oil
- CG SAE 7300 Motor Oil
- CG SAE 7400 Motor Oil
- CG SAE 7500 Motor Oil
- CG SAE 7600 Motor Oil
- CG SAE 7700 Motor Oil
- CG SAE 7800 Motor Oil
- CG SAE 7900 Motor Oil
- CG SAE 8000 Motor Oil
- CG SAE 8100 Motor Oil
- CG SAE 8200 Motor Oil
- CG SAE 8300 Motor Oil
- CG SAE 8400 Motor Oil
- CG SAE 8500 Motor Oil
- CG SAE 8600 Motor Oil
- CG SAE 8700 Motor Oil
- CG SAE 8800 Motor Oil
- CG SAE 8900 Motor Oil
- CG SAE 9000 Motor Oil
- CG SAE 9100 Motor Oil
- CG SAE 9200 Motor Oil
- CG SAE 9300 Motor Oil
- CG SAE 9400 Motor Oil
- CG SAE 9500 Motor Oil
- CG SAE 9600 Motor Oil
- CG SAE 9700 Motor Oil
- CG SAE 9800 Motor Oil
- CG SAE 9900 Motor Oil
- CG SAE 10000 Motor Oil

RA PD
77978

LUBRICATION

RA PD
779788

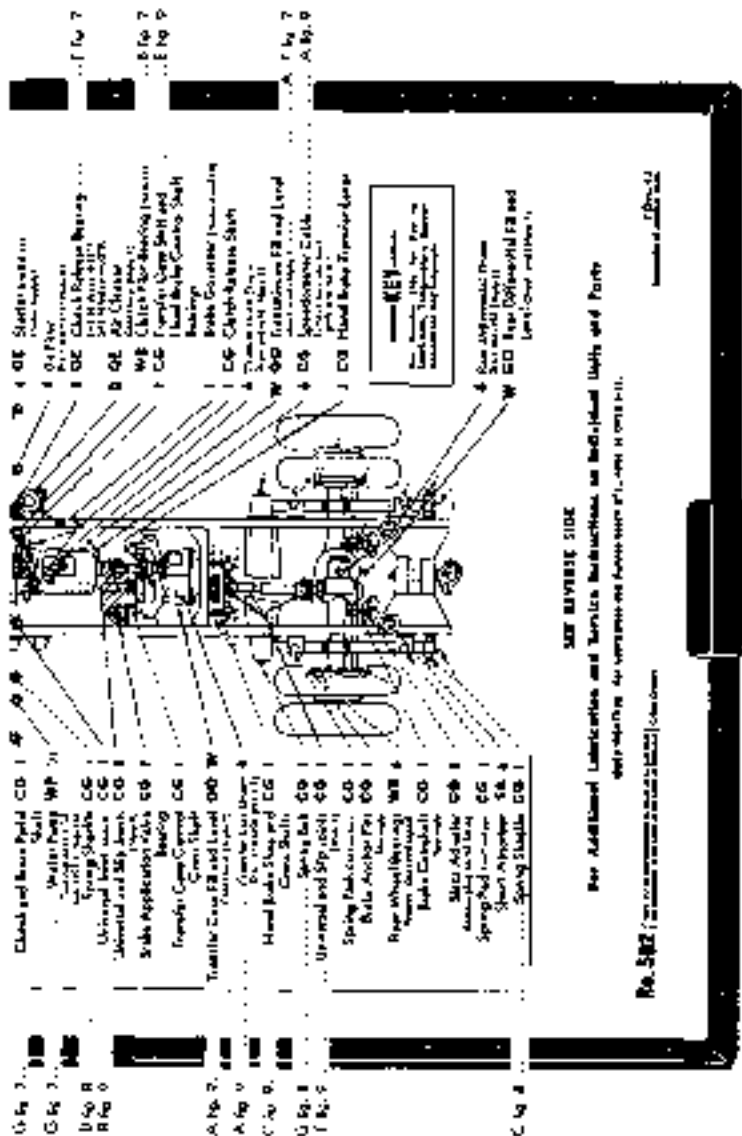

Figure 5 - Lubrication Guide - Tractor

LUBRICATION

RA PD
779608

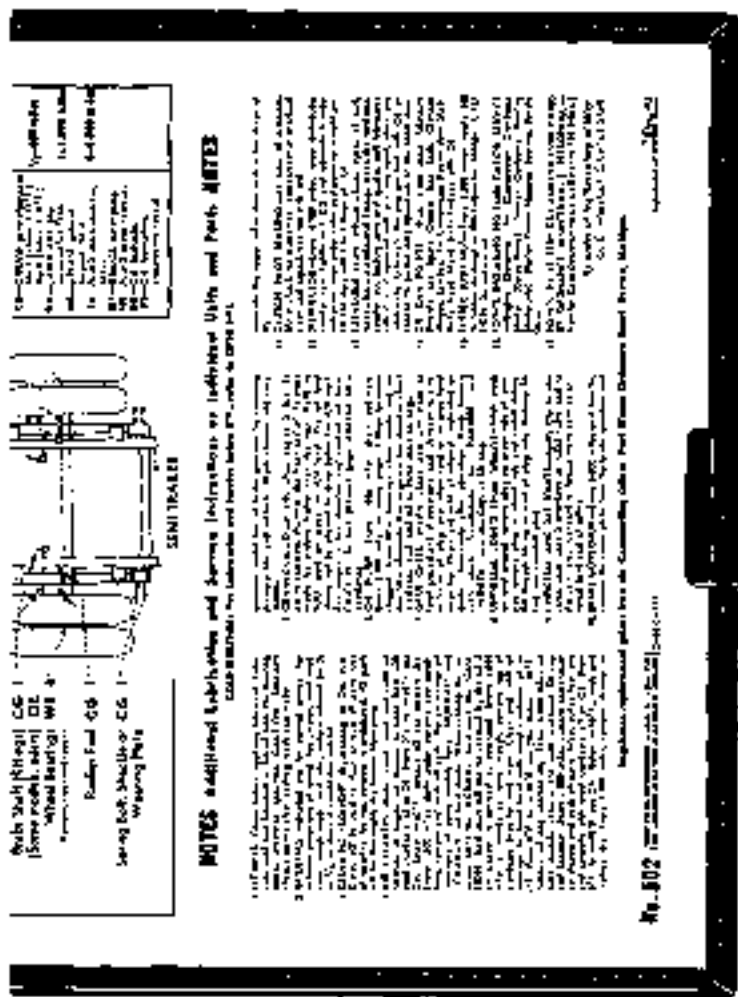

Figure 6 - Lubrication Guide - Semitrailer

4- TO 5-TON 4 x 4 TRACTOR TRUCK (AUTOCAR MODEL U-71447)

to change to grades prescribed for the next lower temperature range. Ordinarily it will be necessary to change grades of lubricants only when air temperatures are consistently in the next higher or lower range, unless malfunctioning occurs sooner due to lubricants being too thin or too heavy.

17. DETAILED LUBRICATION INSTRUCTIONS.

a. Lubrication Equipment. Each piece of material is supplied with lubrication equipment adequate to maintain the material. Be sure to clean this equipment both before and after use. Operate lubricating guns carefully and in such manner as to insure a proper distribution of the lubricant.

b. Points of Application.

(1) Red circles surrounding lubrication fittings, grease cups, oilers, and oilholes make them readily identifiable on the vehicle. Wipe clean such lubricators and the surrounding surface before lubricant is applied.

(2) Where relief valves are provided, apply new lubricant until the old lubricant is forced from the vent. Exceptions are specified in notes on the Lubrication Guide.

c. Lubrication Notes on Individual Units and Parts. The following instructions supplement those notes on the Lubrication Guide which pertain to lubrication and service of individual units and parts. All note references on the Guide itself are to the subparagraph below having the same number.

(1) **FITTINGS.** Clean all fittings before applying lubricant. Lubricate until new lubricant is forced from bearing, unless otherwise specified. **CAUTION:** Lubricate chassis points after washing truck and trailer.

(2) **INTERVALS.** Intervals indicated are for normal service. For extreme conditions of speed, heat, water, sand, mud, snow, rough roads, dust, etc., reduce interval by $\frac{1}{3}$ or $\frac{1}{2}$, or more if conditions warrant.

(3) **CLEANING.** SOLVENT, dry-cleaning, or OIL, fuel, Diesel, will be used to clean or wash all parts. Use of gasoline for this purpose is prohibited. All parts will be thoroughly dry before lubricating.

(4) **AIR CLEANERS.** Daily, check level and refill oil reservoir of engine air cleaner to head level with used crankcase oil or OIL, engine, SAE 30, above $+32^{\circ}\text{F}$. or SAE 10 $+32^{\circ}\text{F}$. to 0°F . Use OIL, hydraulic, from 0°F . to -40°F . Below -40°F ., remove oil and operate dry. Every 1,000 miles, or daily, under extreme dust conditions, remove and wash all parts. The air cleaner oil reservoirs of some models have "NORMAL" and "CAUTION" oil level marks. When re-

LUBRICATION

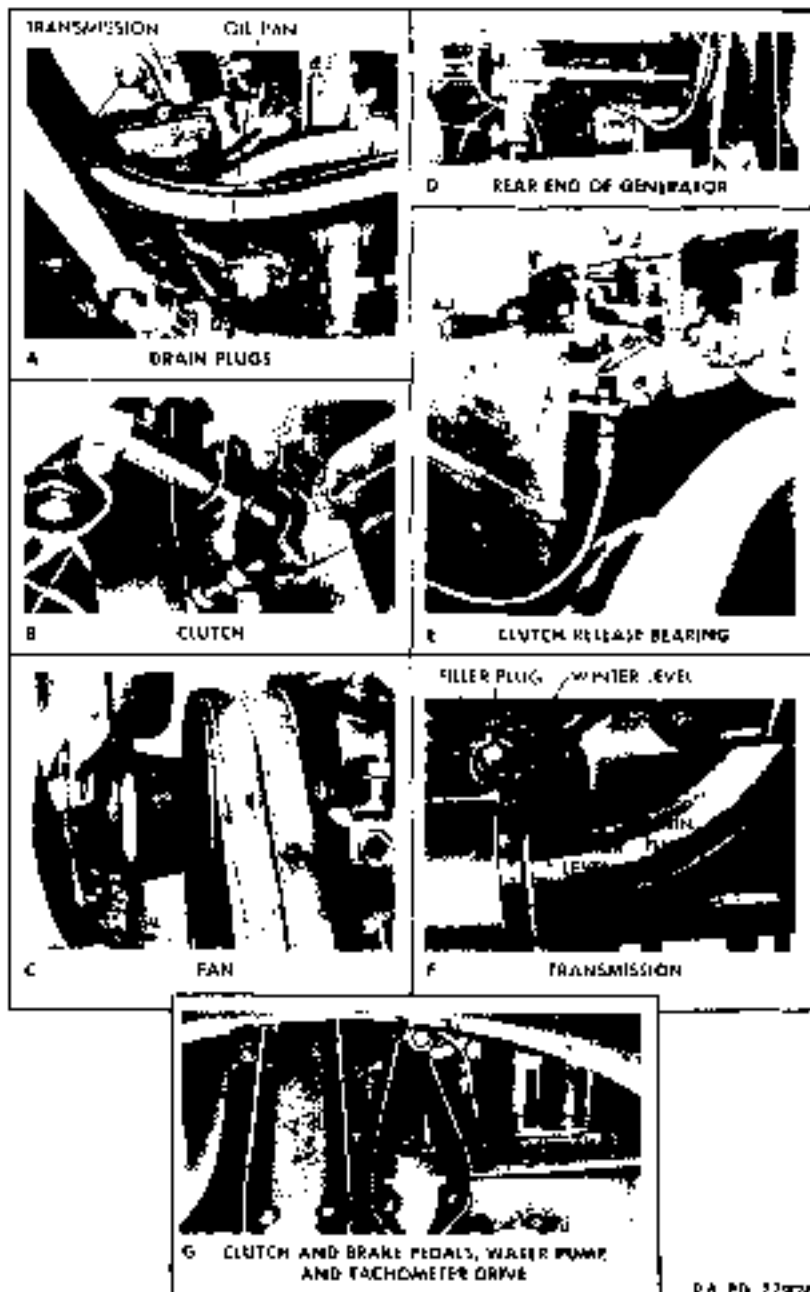

RA PD 27926

Figure 7 - Engine, Clutch, and Transmission -- Lubrication Points

4- TO 5-TON 4x4 TRACTOR TRUCK (AUTOCAR MODEL U-7144T)

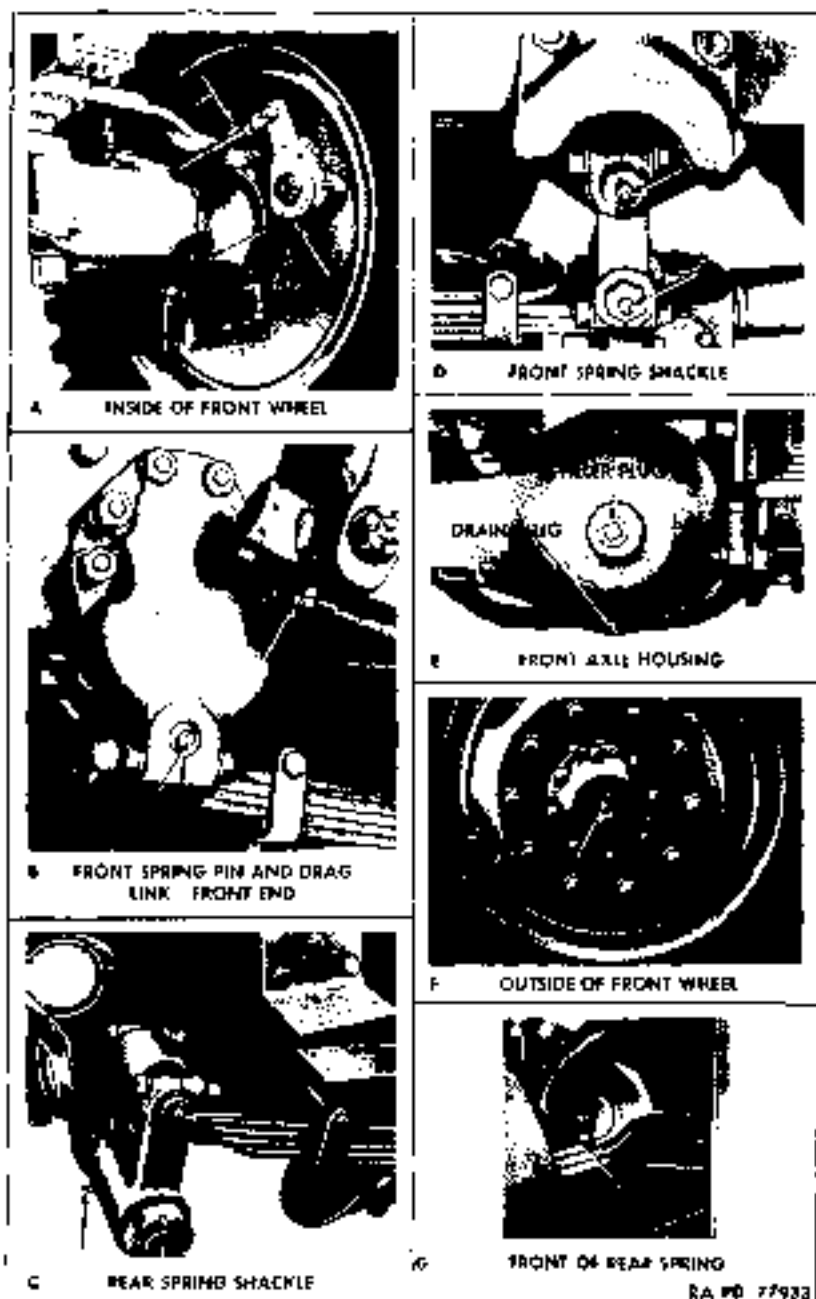

Figure 8 - Wheels, Axles, and Springs - Lubrication Points

LUBRICATION

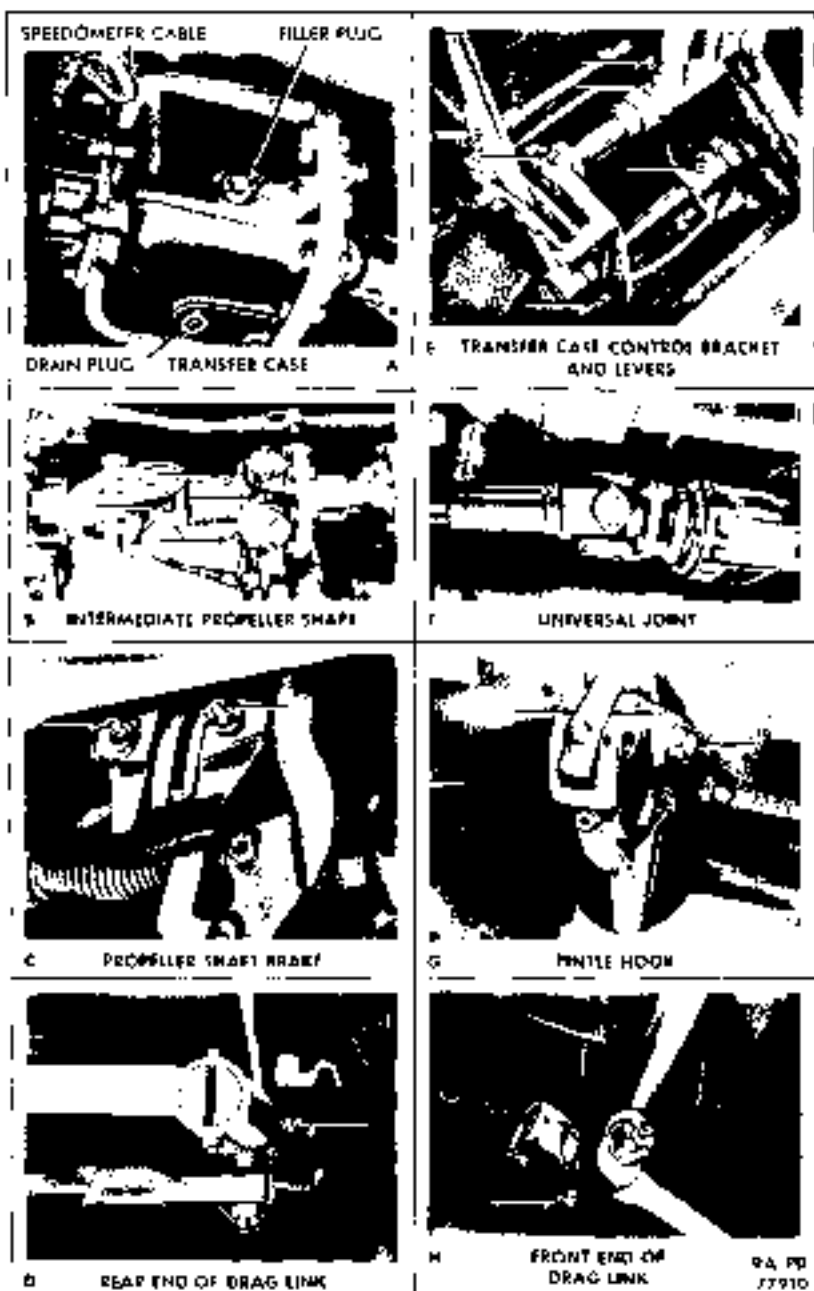

Figure 9 - Miscellaneous Lubrication Points

4- TO 5-TON 4x4 TRACTOR TRUCK (AUTOCAR MODEL U-7144T)

filling the reservoir, fill to the "NORMAL" level mark; the "CAUTION" level mark will not be reached by the oil if the air cleaner is serviced as described. Every 1,000 miles, or weekly on some models, remove top of crankcase breather and wash. Clean and refill oil reservoir to top level with used crankcase oil or OIL, engine, SAE 30, above +32°F. to 0°F. Use OIL, hydraulic, from 0°F. to -40°F. Below -40°F., remove oil and operate dry. Every 6,000 miles on some models, remove and wash crankcase fill cap and breather. Every 1,000 miles, remove compressor air cleaner and wash all parts. Wash curled hair, dry, and saturate with used crankcase oil or OIL, engine, SAE 30, above +32°F. or SAE 10 -32°F. to 0°F. Use OIL, hydraulic, from 0°F. to -40°F. Below -40°F., wash and replace dry. Every 1,000 miles, remove strainer in governor outlet line of brake governor by removing pressure line and retainer. Wash strainer and reassemble.

(5) **CRANKCASE.** Drain only when engine is hot. To aid in complete draining, the front end of the truck should be slightly higher than the rear. Refill to "FULL" mark on gage, or 4/4 level. The oil level should not be allowed to drop below the 2/4 mark. Run engine a few minutes and recheck oil level. **CAUTION:** *Be sure pressure gage indicating oil is circulating.*

(6) **OIL FILTER.** Every 1,000 miles, drain sediment. Every 6,000 miles or more often if filter becomes clogged, drain filter housings, clean inside, and renew filter elements. Run engine a few minutes, check crankcase level, and add oil to "FULL" mark on gage.

(7) **GEAR CASES (A and F, fig. 7, E, fig. 8; A, fig. 9).** Weekly, check level with truck on level ground and, if necessary, add lubricant to within 1/2 inch of plug level when cold, or to plug level when hot. Drain and refill at intervals indicated on guide. Drain only after operation. Keep housing vents clean. Transmission has "SUMMER" and "WINTER" level markings at filler plug.

(8) **UNIVERSAL JOINTS (FRONT WHEELS) (A, fig. 8).** With truck on level ground, remove plug on under side of joint; also remove plug in wheel hub and install fitting. Fill through fitting to level of plug hole. Remove fitting and reinstall plug.

(9) **UNIVERSAL AND SLIP JOINTS (B and F, fig. 9).** Apply GREASE, general purpose, No. 1 above +32°F. and No. 0 below +32°F. to universal joint until it overflows at relief valve, and to slip joint until lubricant is forced from vent at universal joint end of spline.

(10) **BRAKE GOVERNOR.** Every 6,000 miles or 6 months, remove the cover plate from the brake governor, and lubricate the upper valve stem with a few drops of OIL, lubricating, preservative, special.

LUBRICATION

(11) **CLUTCH PILOT BEARING.** At time of disassembly of clutch for inspection, replacement, or overhaul, clean and repack bearing with **GREASE**, general purpose, No. 2.

(12) **DISTRIBUTOR.** Every 6,000 miles, wipe distributor breaker cam lightly with **GREASE**, general purpose, No. 1 above -32°F . and No. 0 below $+32^{\circ}\text{F}$., and lubricate breaker arm pivot, wick under rotor, and governor weight pivots and slots with one to two drops of **OIL**, engine, SAE 30, above $+32^{\circ}\text{F}$. or SAE 10 $+32^{\circ}\text{F}$. to 0°F .. Below 0°F ., use **OIL**, lubricating, preservative, special.

(13) **TURNTABLE (FIFTH WHEEL).** Some types of early models have two additional fittings. Keep the turntable, coupler pin locking jaws, and guides well lubricated with **GREASE**, general purpose, No. 1 above $+32^{\circ}\text{F}$. and No. 0 below $+32^{\circ}\text{F}$.. If covered with grit and sand, clean and relubricate. Lubricate the kingpin lock with **OIL**, engine, SAE 30, above $+32^{\circ}\text{F}$. or SAE 10 $+32^{\circ}\text{F}$. to 0°F .. Below 0°F ., use **OIL**, lubricating, preservative, special, as needed, to permit easy operation of hand lever.

(14) **OILCAN POINTS (4, fig. 9).** Every 1,000 miles, lubricate throttle and spark control rod ends, clevises, hinges, latches, air compressor rocker arm shaft, pintle hook, and hand brake linkage with **OIL**, engine, SAE 30 above -32°F . or SAE 10 $+32^{\circ}\text{F}$. to 0°F .. Below 0°F ., use **OIL**, lubricating, preservative, special.

(15) **RUBBER BUSHINGS.** Every 1,000 miles, apply **FLUID**, brake, hydraulic, to rubber bushings in shock absorber linkage. **CAUTION:** *Do not use oil.*

(16) **POINTS REQUIRING NO LUBRICATION SERVICE.** Engine governor, air compressor crankcase starter (Delco-Remy), starter outboard bearing (Auto-Lite), starter pinion housing bearing, and the Bendix drive do not require lubrication service.

(17) **POINTS TO BE SERVICED AND/OR LUBRICATED BY ORDNANCE MAINTENANCE PERSONNEL.** The transfer case declutching unit must be serviced and/or lubricated by ordnance maintenance personnel.

d. **Reports and Records.** If lubrication instructions are closely followed, proper lubricants used, and satisfactory results are not obtained, make a report to the ordnance officer responsible for the maintenance of the materiel. A complete record of lubrication servicing may be kept in the Duty Roster (W.D., AGO Form No. 6).

e. **Localized Views.** The localized views of lubrication points (figs. 7, 8, and 9) supplement the instructions on the Guide and in the notes.

4- TO 5-TON 4 x 4 TRACTOR TRUCK (AUTOCAR MODEL U-7144T)

Section VII

TOOLS AND EQUIPMENT STOWAGE ON THE VEHICLE

18. VEHICLE TOOLS, EQUIPMENT, AND SPARE PARTS.

a. Purpose. The lists which follow are for reference purposes only. They are not to be used as a basis for requisition.

b. Vehicle Tools.

Description	Federal Stock No.
HAMMER, machinist, ball-peen 16-oz	41-H-523
HANDLE, wrench, wheel stud nut	41-S-1517-50
JACK, hydraulic, 8-ton, w/handle	41-J-73-5
PLIERS, combination, slip joint, 6-in.	41-P-1650
SCREWDRIVER, comm., heavy-duty integ. handle, 6-in. blade	41-S-1076
SCREWDRIVER, cross recess hd., type 2, 4-in. blade	41-S-1638
SCREWDRIVER, cross recess hd., type 3, 6-in. blade	41-S-1640
WRENCH, adj. single end, 12-in. ($1\frac{1}{16}$ -in. capacity)	41-W-488
WRENCH, engineer's, double-hd. alloy steel, $\frac{5}{8}$ -x $\frac{3}{4}$ -in.	41-W-991
WRENCH, engineer's, double-hd. alloy steel, $\frac{3}{2}$ -x $1\frac{1}{16}$ -in.	41-W-1003
WRENCH, engineer's, double-hd. alloy steel, $\frac{3}{4}$ -x $1\frac{1}{16}$ -in.	41-W-1005-5
WRENCH, engineer's, double-hd. alloy steel, $\frac{5}{8}$ -x $\frac{5}{16}$ -in.	41-W-1008-10
WRENCH, engineer's, double-hd. alloy steel, $\frac{3}{4}$ -x $\frac{1}{2}$ -in.	41-W-1012-5
WRENCH, screw, adjustable, auto, 15-in. ($3\frac{3}{4}$ -in. capacity)	41-W-450
WRENCH, socket, front wheel bearing nut	41-W-1493-25
WRENCH, socket-hd. set screw $\frac{1}{16}$ -in. hex, 6 $\frac{1}{2}$ in. long	
WRENCH, socket, rear wheel bearing nut	41-W-1991-10
WRENCH, spark plug, 14-mm, $1\frac{1}{16}$ -in. hex, w/handle	
WRENCH, water pump nut	
WRENCH, wheel stud nut, double-end, $1\frac{1}{16}$ in. sq and $1\frac{1}{16}$ in. hex, 14 $\frac{3}{8}$ in. long	41-W-3838-40

c. Vehicle Equipment.

ADAPTER, lubr., gun	
APPARATUS, decontaminating	
BAG, tool	41-B-15
CATALOG, standard parts list	SNL G-510
CHAINS, tire 9.00 x 20, type TD (2)	8-C-1625

TOOLS AND EQUIPMENT STORAGE ON THE VEHICLE

Description	Federal Stock No.
CHAINS, tire 9.00 x 20, type TS (2)	8-C-2440
CONTAINER, 5-gal, liquid	
CRANK, starting	
EXTINGUISHER, fire 1-qt, CCL4	58-E-202
GAGE, tire pressure	8-G-615
GUIDE, Lubrication, War Dept. No. 502	
GUN, lubr., lever type	41-G-1330-60
HOSE, tire inflation, w/sir chuck	
HOSE, trailer, 112 1/2 in. long (BWE 215604)	
HOSE, trailer, 216 in. long (BWE 220570)	
MANUAL, Technical (in envelope)	
NOZZLE, flexible tube	
OILER, straight spout, spring bottom, 1/2-pt.	13-0-1530
RIFLE	
TAPE, friction, black, Grade A, 3/4 in. wide, 8-oz roll	17-T-805
TOOL set, pioneer equip. motor vehicle set No. 1, consisting of:	
AXE, chopping, single bit, 4-lb.	41-A-1277
MATTOCK, pick, M1, w/handle	41-M-720
SHOVEL, D-handle, round point	41-S-3170
WIRE, iron, annealed 22 gage, 1/4-lb spool	22-W-1067
d. Vehicle Spare Parts.	
CONTAINER, metal spare parts, consisting of	8-C-5498-50
BELT, fan	33-B-178
CAP, tire, valve (5)	8-C-650
CORE, tire, valve (5)	8-C-6750
LAMP, elec, incand. min. 6- to 8-V, sgle-tung-fl, 3-cp (MZ 63)	17-L-5215
LAMP-UNIT, blackout stop, sealed, one opening, 6- to 8-V 3-cp	8-L-421
LAMP-UNIT, blackout tail, sealed, 4 openings, 6- to 8-V 3-cp	8-L-415
LAMP-UNIT, service tail and stop, sealed, 6- to 8-V	8-L-419
PIW, cotter, split, S. assorted (boxed)	42-P-5347
PLUG, spark, w/gasket	17-P-5355

4- TO 5-TON 4 x 4 TRACTOR TRUCK (AUTOCAR MODEL U-7144T)

RA PD 77699

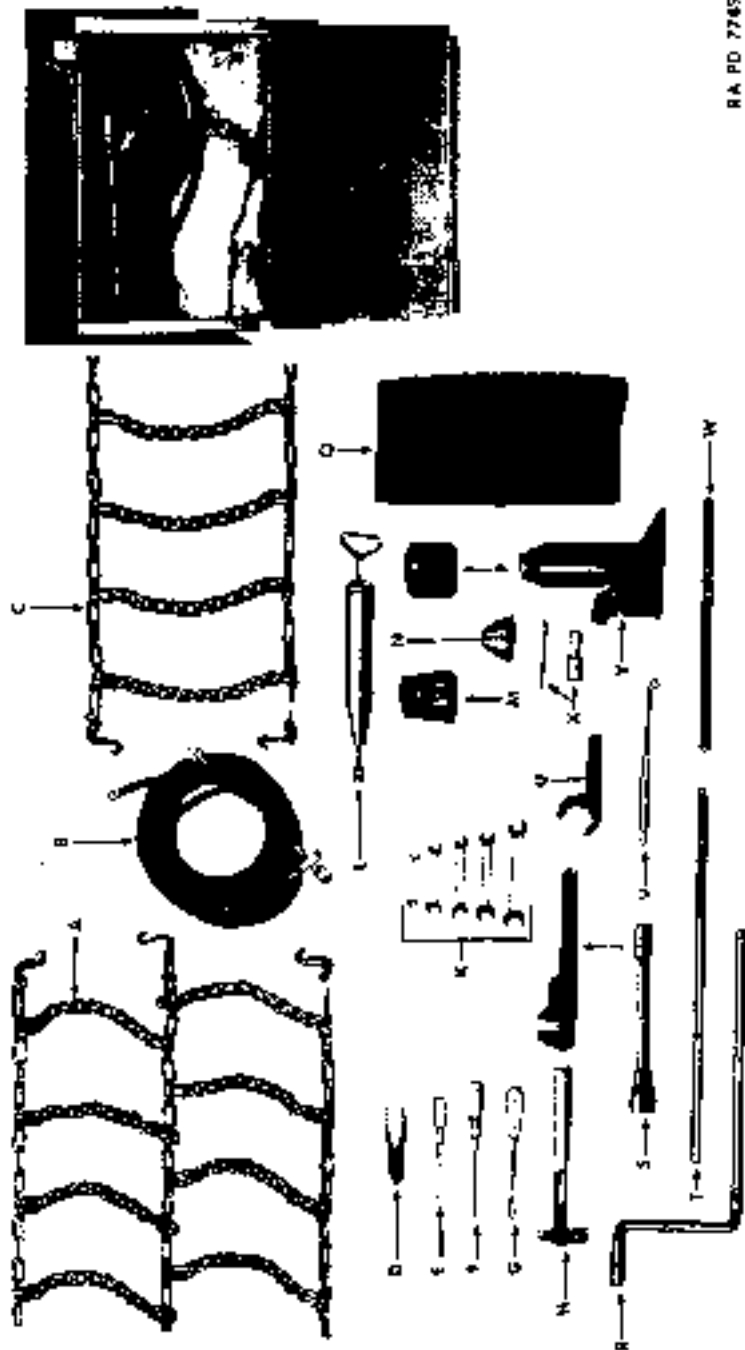

Figure 10 - Vehicle Tools and Equipment

TOOLS AND EQUIPMENT STOWAGE ON THE VEHICLE

- A—DUAL 9.00 x 20 TIRE CHAIN
- B—TIRE INFLATION HOSE
- C—SINGLE 9.00 x 20 TIRE CHAIN
- D—WIRE CUTTING SLIP JOINT COMBINATION PLIERS
- E—TYPE NO. 2 CROSS RECESSED TYPE SCREWDRIVER
- F—TYPE NO. 3 CROSS RECESSED TYPE SCREWDRIVER
- G—HEAVY-DUTY SCREWDRIVER WITH INTEGRAL HANDLE
- H—16-OZ. MACHINIST BALL PEEN HAMMER
- J—AUTOMOBILE TYPE ADJUSTABLE WRENCH
- K—OPEN-END, DOUBLE-HEAD, 15-DEGREE ENGINEER WRENCH SET
- L—HYDRAULIC CHASSIS LUBRICATING GUN
- M—FRONT WHEEL BEARING ADJUSTING NUT WRENCH
- N—OILER
- P—REAR WHEEL BEARING ADJUSTING NUT WRENCH
- Q—CLOTH TOOL CASE
- R—ENGINE STARTING CRANK
- S—WHEEL NUT WRENCH
- T—WHEEL WRENCH HANDLE
- U—WATER PUMP NUT WRENCH
- V—TIRE PRESSURE GAGE
- W—HYDRAULIC JACK HANDLE
- X—SPARK PLUG WRENCH
- Y—HYDRAULIC JACK

RA PD 77B99B

Legend for Figure 10 — Vehicle Tools and Equipment

PART TWO — VEHICLE MAINTENANCE INSTRUCTIONS

Section VIII

VEHICLE MODIFICATION RECORDS

19. MWO AND MAJOR UNIT ASSEMBLY REPLACEMENT RECORD.

a. **Description.** Every vehicle is supplied with a copy of AGO Form No. 478 which provides a means of keeping a record of each MWO completed or major unit assembly replaced. This form includes spaces for the vehicle name and U.S.A. Registration Number, instructions for use, and information pertinent to the work accomplished. It is very important that the form be used as directed and that it remain with the vehicle until the vehicle is removed from service.

b. **Instructions for Use.** Personnel performing modifications or major unit assembly replacements, must record clearly on the form a description of the work completed, and must initial the form in the columns provided. When each modification is completed, record the date, hours and/or mileage, and MWO number. When major unit assemblies, such as engines, transmissions, or transfer cases are replaced, record the date, hours and/or mileage, and nomenclature of the unit assembly. Minor repairs and minor parts and accessory replacements need not be recorded.

c. **Early Modifications.** Upon receipt, by a third or fourth echelon repair facility, of a vehicle for modification or repair, maintenance personnel will record the MWO numbers of modifications applied prior to the date of AGO Form No. 478.

Section IX

NEW VEHICLE RUN-IN TEST

20. INTRODUCTION.

a. **Purpose.** When a new or reconditioned vehicle is received at the using organization, it is necessary for second echelon personnel to determine whether or not the vehicle will operate satisfactorily when placed in service. For this purpose, inspect all accessories, subassemblies, assemblies, tools, and equipment to see that they are in place

NEW VEHICLE RUN-IN TEST

and correctly adjusted. In addition, they will perform a run-in test of at least 50 miles as directed in AR 850-15, according to procedures in paragraph 21 below.

b. Correction of Deficiencies. Deficiencies disclosed during the course of the run-in test will be treated as follows:

- (1) Correct any deficiencies within the scope of the maintenance echelon of the using organization before the vehicle is placed in service.
- (2) Refer deficiencies beyond the scope of maintenance echelon of the using organization to a higher echelon for correction.
- (3) Bring deficiencies of serious nature to the attention of the supplying organization.

21. RUN-IN TEST PROCEDURES.

a. Preliminary Service.

(1) **FIRE EXTINGUISHER.** See that portable extinguisher is present and in good condition. Test it momentarily for proper operation, and mount it securely.

(2) **FUEL, OIL, AND WATER.** Fill fuel tank. Check crankcase oil and coolant supply, and add as necessary to bring to correct levels. Allow room for expansion in fuel tank and radiator. During freezing weather, test value of antifreeze and add as necessary, to protect cooling system against freezing. **CAUTION:** *If there is a tag attached to filler cap or steering wheel concerning engine oil in crankcase, follow instructions on tag before driving the vehicle.*

(3) **FUEL FILTER.** Inspect fuel filter for leaks, damage, and secure mountings and connections. Remove sediment bowl drain plug, and drain dirt and water. If any appreciable amount of water or dirt is present, remove elements and clean cases and elements in dry-cleaning solvent. Replace elements, using new gaskets.

(4) **BATTERIES.** Make hydrometer and voltage test of batteries. If necessary, add distilled or clean water, to one-half inch above plates.

(5) **AIR BRAKE TANKS.** Drain water from all air brake reservoir tanks and close drain cocks.

(6) **AIR CLEANERS AND BREATHER CAP.** Examine carburetor, air compressor, air cleaners, and crankcase breather cap to see if they are in good condition and secure. Remove elements and wash thoroughly in dry-cleaning solvent. Fill reservoirs to head level with fresh oil and reinstall securely. Be sure all gaskets are in good condition, and that ducts and air horn connections are tight.

(7) **ACCESSORIES AND BELTS.** Make sure that accessories such as carburetor, generator, regulator, cranking motor, distributor, water pump, fan, oil filter, and air compressor are securely mounted. Check

4. TO 5-TON 4 x 4 TRACTOR TRUCK (AUTOCAR MODEL U-7144T)

the fan, generator, and air compressor belts for good condition and adjustment. Belts must have $\frac{1}{2}$ - to $\frac{3}{8}$ -inch finger-pressure deflection.

(8) **ELECTRICAL WIRING.** Examine all accessible wiring and conduits to see if they are in good condition, securely connected, and properly supported.

(9) **TIRES.** Make sure that all tires, including spare, are properly inflated to 65 pounds. Be sure that stems are in correct position, and all valve caps present and finger-tight. Remove objects lodged in treads and carcasses and between duals, and inspect for damage.

(10) **WHEEL AND FLANGE NUTS.** See that all wheel mounting and axle flange nuts are present and secure.

(11) **FENDERS AND BUMPER.** Examine fenders and bumper for looseness and damage.

(12) **TOWING CONNECTIONS.** Inspect towing hooks, truck tractor fifth wheel, and pintle hook for looseness or damage.

(13) **BODY (CAB).** Make sure that all cab and body mountings are secure. Inspect attachments, hardware, glass, doors, and windows to see that they are in good condition, secure, and operate properly. See that fifth wheel is properly assembled, in good condition, and securely mounted. Be sure trailer connecting mechanism operates properly and latches securely. See that trailer brake lines and connections are in good condition and securely connected or supported. Test all hinges, locks, windshield, and window lift mechanism to see that they function satisfactorily.

(14) **LUBRICATE.** Perform a complete lubrication of the vehicle, covering all intervals, according to the instructions on the Lubrication Guide, section VI, except gear cases, wheel bearings, and other units lubricated in steps (1) to (14). Check all gear case oil levels, and add as necessary to bring to correct level. Change only if condition of oil indicates the necessity, or if gear oil is not of proper grade for existing atmospheric temperature. **NOTE: Perform steps (15) through (18) during lubrication.**

(15) **SPRINGS AND SUSPENSIONS.** Inspect springs for sag, broken or shifted leaves, and loose clips. Check shock absorbers for secure mounting and linkage.

(16) **STEERING LINKAGE.** Be sure that all steering arms, rods, and connections are in good condition and secure. Make sure that gear case is securely mounted and not leaking excessively.

(17) **PROPELLER SHAFTS.** Inspect all propeller shafts and universal joints to see if they are in good condition, correctly assembled, aligned, secure, and not leaking excessively.

(18) **AXLE AND TRANSFER VENTS.** See that axle housing and transfer case vents are present, in good condition, and not clogged.

NEW VEHICLE RUN-IN TEST

(19) **CHOKE.** Examine choke to be sure it opens and closes fully in response to operation of choke button.

(20) **ENGINE WARM-UP.** During cold weather, when starting engine, test manifold preheating unit for proper operation. Start engine, and note if cranking motor action is satisfactory, and engine has any tendency toward hard starting. Set hand throttle to run engine at fast idle during warm-up period.

(21) INSTRUMENTS.

(a) Immediately after starting engine, observe if oil pressure is satisfactory. (Normal pressures, hot, are 30 to 50 pounds at operating speeds, 5 pounds minimum at idle speed). Stop engine if oil pressure is not indicated in 30 seconds.

(b) *Ammeters.* Main ammeter should show slight positive charge for a short period after starting engine, until generator restores to battery the current used in starting. The "B" ammeter should show charge to indicate "B" battery is receiving current from generator.

(c) *Temperature Gage.* Engine temperature should rise gradually, during warm-up period, to normal operating range, 157°F to 183°F.

(d) *Tachometer.* White pointer should indicate actual engine revolutions per minute at any given time. Red pointer indicates and remains at highest revolutions per minute attained, and should not exceed recommended governed engine speed, 2,400 revolutions per minute.

(e) *Viscosity Gage.* After engine has reached operating temperature, viscosity gage reading should remain in "ideal" range.

(f) *Air Pressure Gage.* During warm-up, air pressure should build up to 105 pounds. Governor should cut off air from compressor at this pressure, and should again cut in if pressure in lines and reservoirs is reduced to 85 pounds. Warning indicator (buzzer) should sound at pressure below 60 pounds.

(g) *Fuel Gage.* Fuel gage should register "FULL" if tank has been filled.

(22) **ENGINE CONTROLS.** Observe if engine responds properly to controls and if controls operate without excessive looseness or binding.

(23) **HORN AND WINDSHIELD WIPERS.** See that these items are in good condition and secure. If tactical situation permits, test horn for proper operation and tone. See if wiper arms will operate through their full range and that blade contacts glass evenly and firmly.

(24) **GLASS AND REAR VIEW MIRRORS.** Clean all body glass and mirrors, and inspect for looseness and damage. Adjust rear view mirrors for correct vision.

4. TO 5-TON 4 x 4 TRACTOR TRUCK (AUTOCAR MODEL U-7144T)

(25) **LAMPS (LIGHTS) AND REFLECTORS.** Clean lenses and inspect all units for looseness and damage. If tactical situation permits, open and close all light switches to see if lamps respond properly.

(26) **LEAKS, GENERAL.** Look under vehicle and within engine compartment for indications of fuel, oil, and coolant leaks. Trace any leaks found to source, and correct or report them to designated authority.

(27) **TOOLS AND EQUIPMENT.** Check tools and On Vehicle Stowage Lists (par. 18), to be sure all items are present, serviceable, and properly mounted or stowed.

b. Run-in Test. Perform the following steps (1) to (11) inclusive during the road test of the vehicle. On vehicles which have been driven 50 miles or more in the course of delivery from the supplying to the using organization, reduce the length of the road test to the least mileage necessary to make observations listed below. **CAUTION:** *Continuous operation of the vehicle at speed approaching the maximum indicated on the caution plate should be avoided during the test.*

(1) **DASH INSTRUMENTS AND GAGES.** Do not move vehicle until engine temperature reaches 135°F. Maximum safe operating temperature is 200°F. Observe readings of oil gage, ammeters, temperature gage, air pressure gage, tachometer, viscometer, and fuel gage to be sure they are indicating the proper function of the units to which they apply. Also make sure that speedometer registers the vehicle speed, and that odometer registers accumulating mileage.

(2) **BRAKES, FOOT AND HAND.** Test service air brakes to see if they stop vehicle effectively without side pull, chatter, or squealing. Be sure application valve closes when treadle pressure is released, and that there is not an excessive drop in air pressure when brakes are applied. Parking brake should hold vehicle on a reasonable incline, with one-half ratchet travel in reserve and should lock securely in applied position. **CAUTION:** *Avoid long application of brakes until shoes have become completely seated. Do not apply full treadle pressure except for an emergency stop.*

(3) **CLUTCH.** Observe if clutch operates smoothly without grab, chatter, or squeal on engagement, or slippage when fully engaged under load. See that pedal has 1½-inch free travel before meeting resistance. **CAUTION:** *Do not ride clutch pedal at any time, and do not engage and disengage new clutch severely or unnecessarily until driven and driving disks have become properly worn in.* **NOTE:** *Never allow pedal free play to become less than three-fourths inch. Adjust only according to instructions in paragraph 59.*

(4) **TRANSMISSION AND TRANSFER.** Gearshift mechanism should operate smoothly and easily; gears should operate without unusual noise, and not slip out of mesh. Test front axle declutching and power take-off mechanisms (if so equipped) for proper operation.

SECOND ECHELON PREVENTIVE MAINTENANCE

(5) **STEERING.** Observe steering action for binding or looseness, and note any excessive pull to one side, wander, shimmy, or wheel tramp. Make sure that column bracket and wheel are secure.

(6) **ENGINE.** Be on the alert for any abnormal engine operating characteristics or unusual noise, such as lack of pulling power or acceleration, backfiring, misfiring, stalling, overheating, or excessive exhaust smoke. Observe if engine responds properly to all controls.

(7) **UNUSUAL NOISE.** Be on the alert throughout road test for any unusual noise from body and attachments, running gear, suspensions, or wheels that might indicate looseness, damage, wear, inadequate lubrication, or under-inflated tires.

(8) **HALT VEHICLE AT 10-MILE INTERVALS FOR SERVICES (9) TO (11) BELOW.**

(9) **AIR BRAKE SYSTEM LEAKS.** With air pressure at governed maximum (105 lb.) and brakes applied, stop the engine. There should not be a noticeable drop in pressure in 1 minute.

(10) **TEMPERATURES.** Cautiously hand-feel each brake drum and wheel hub for abnormal temperatures. Examine transmission and rear axle housings for indications of overheating, or excessive lubricant leaks at seals, gaskets, or vents.

(11) **LEAKS.** With engine running, and fuel, engine oil, and cooling systems under pressure, look within engine compartment and under vehicle for indications of leaks.

c. Vehicle Publications and Reports.

(1) **PUBLICATIONS.** See that vehicle Technical Manuals, Lubrication Guide, Standard Form No. 26 (Drivers Report-Accident, Motor Transportation), and W.D., AGO Form No. 478 (MWO and Major Unit Assembly Replacement Record), are in the vehicle, legible, and properly stowed. *NOTE: U.S.A. registration number and vehicle nomenclature must be filled in on Form No. 478 for new vehicles.*

(2) Upon completion of run-in test, correct or report any deficiencies noted. Report general condition of vehicle to designated individual in authority.

Section X

SECOND ECHELON PREVENTIVE MAINTENANCE

22. SECOND ECHELON PREVENTIVE MAINTENANCE SERVICES.

a. Regular scheduled maintenance inspections and services are a preventive maintenance function of the using arms and are the responsibility of commanders of operating organizations.

4. TO 5-TON 4 x 4 TRACTOR TRUCK (AUTOCAR MODEL U-7144T)

(1) **FREQUENCY.** The frequency of the preventive maintenance services outlined herein is considered a minimum requirement for normal operation of vehicles. Under unusual operating conditions, such as extreme temperatures, dusty or sandy terrain, it may be necessary to perform certain maintenance services more frequently.

(2) **FIRST ECHOLON PARTICIPATION.** The drivers should accompany their vehicles and assist the mechanics while periodic second echelon preventive maintenance services are performed. Ordinarily the driver should present the vehicle for a scheduled preventive maintenance service in a reasonably clean condition; that is, it should be dry and not caked with mud or grease to such an extent that inspection and servicing will be seriously hampered. However, the vehicle should not be washed or wiped thoroughly clean, since certain types of defects, such as cracks, leaks, and loose or shifted parts or assemblies, are more evident if the surfaces are slightly soiled or dusty.

(3) If instructions other than those contained in the general procedures in step (4) or the specific procedures in step (5) which follow, are required for the correct performance of a preventive maintenance service, or for correction of a deficiency, refer to other sections of this manual pertaining to the item involved, or report to designated authority.

(4) **GENERAL PROCEDURES.** These general procedures are basic instructions which are to be followed when performing the services on the items listed in the specific procedures. **NOTE:** *The second echelon personnel must be thoroughly trained in these procedures so that they will apply them automatically.*

(a) When new or overhauled subassemblies are installed to correct deficiencies, care should be taken to see that they are clean, correctly installed, properly lubricated, and adjusted.

(b) When installing new lubricant retainer seals, a coating of the lubricant should be wiped over the sealing surface of the lip of the seal. When the new seal is a leather seal, it should be soaked in SAE 10 engine oil (warm if practicable) for at least 30 minutes. Then the leather lip should be worked carefully by hand before installing the seal. The lip must not be scratched or marred.

(c) The general inspection of each item applies also to any supporting member or connection, and usually includes a check to see whether or not the item is in good condition, correctly assembled, secure, or excessively worn. The mechanic must be thoroughly trained in the following explanations of these terms.

1. The inspection for "good condition" is usually an external visual inspection to determine if the unit is damaged beyond safe or serviceable limits. The term "good condition" is explained further by the

SECOND ECHOLON PREVENTIVE MAINTENANCE

following terms: not bent or twisted, not chafed or burned, not broken or cracked, not bare or frayed, not dented or collapsed, not torn or cut.

2. The inspection of a unit to see that it is "correctly assembled" is usually an external visual inspection to see whether or not it is in its normal assembled position in the vehicle.

3. The inspection of a unit to determine if it is "secure" is usually an external visual examination, a wrench, hand-feel, or a pry-bar check for looseness. Such an inspection should include any brackets, lock washers, lock nuts, lock wires, or cotter pins used in assembly.

4. "Excessively worn" will be understood to mean worn close to, or beyond serviceable limits, and likely to result in a failure if not replaced before the next scheduled inspection.

(d) *Special Services.* These are indicated by repeating the item numbers in the columns which show the interval at which the services are to be performed, and show that the parts, or assemblies, are to receive certain mandatory services. For example, an item number in one or both columns opposite a TIGHTEN procedure, means that the actual tightening of the object must be performed. The special services include:

1. *Adjust.* Make all necessary adjustments in accordance with the pertinent section of this manual, special bulletins, or other current directives.

2. *Clean.* Clean units of the vehicle with dry-cleaning solvent to remove excess lubricant, dirt, and other foreign material. After the parts are cleaned, rinse them in clean fluid and dry them thoroughly. Take care to keep the parts clean until reassembled, and be certain to keep cleaning fluid away from rubber or other material that it would damage. Clean the protective grease coating from new parts since this material is usually not a good lubricant.

3. *Special Lubrication.* This applies either to lubrication operations that do not appear on the vehicle Lubrication Guide, or to items that do appear on such guides, but should be performed in connection with the maintenance operations, if parts have been disassembled for inspection or service.

4. *Serve.* This usually consists of performing special operations, such as replenishing battery water, draining and refilling units with oil, and changing or cleaning the oil filter or cartridge.

5. *Tighten.* All tightening operations should be performed with sufficient wrench torque (force on the wrench handle) to tighten the unit according to good mechanical practice. Use torque-indicating wrench where specified. Do not over-tighten, as this may strip threads or cause distortion. Tightening will always be understood to include the correct installation of lock washers, lock nuts, and cotter pins provided to secure the tightening.

4- TO 5-TON 4 x 4 TRACTOR TRUCK (AUTOCAR MODEL U-71447)

(e) When conditions make it difficult to perform the complete preventive maintenance procedures at one time, they can sometimes be handled in sections, planning to complete all operations within the week if possible. All available time at halts, and in bivouac areas, must be utilized if necessary to assure that maintenance operations are completed. When limited by the tactical situation, items with special services in the columns should be given first consideration.

(f) The numbers of the preventive maintenance procedures that follow are identical with those outlined on W.D. AGO Form No. 461, which is the Preventive Maintenance Service Work Sheet for Wheeled and Half-track Vehicles. Certain items on the work sheet, that do not apply to this vehicle, are not included in the procedures in this manual. In general, the numerical sequence of items on the work sheet is followed in the manual procedures, but in some instances, there is deviation for conservation of the mechanic's time and effort.

(5) **SPECIFIC PROCEDURES.** The procedures for performing each item in the 1000-mile (monthly) and 6000-mile (6-month) maintenance procedures are described in the following chart. Each page of the chart has two columns at its left edge corresponding to the 6000-mile and 1000-mile maintenance respectively. Very often it will be found that a particular procedure does not apply to both scheduled maintenances. In order to determine which procedure to follow, look down the column corresponding to the maintenance due, and, wherever an item number appears, perform the operations indicated opposite the number.

MAINTENANCE	
6,000-Mile (6 mo.)	1,000-Mile (1 mo.)
1	1
2	2

ROAD TEST

NOTE: When the tactical situation does not permit a full road test, perform those items which require little or no movement of the vehicle. When a road test is possible, it should be for preferably 5 miles and not over 10 miles.

1 Before-operation Service. Perform the Before-operation Service as described in paragraph 12, as a check to determine whether or not the vehicle is in a satisfactory condition to make the road test safely, and to see also that the supply of fuel, engine oil, and coolant is adequate.

2 Air Pressure (Build-up, Governor Cut-off, Low Pressure Indicator). During warm-up period, operate engine at fast idle long enough to observe if air brake pressure builds up at normal rate to specified maximum (105 lb) and that governor then cuts off air from compressor. With engine at normal idling

SECOND ECHELON PREVENTIVE MAINTENANCE

MAINTENANCE	
4,000- Mile MAX Interval	1,000- Mile MINIMUM Interval
3	3

speed, bleed air pressure from system by repeated brake application, and observe if compressor cuts in at about 85 pounds. Low pressure indicator (buzzer) should sound at pressures below 60 pounds. Any abnormal drop in air pressure, except from brake application, should be investigated by making elimination soapuds tests.

Dash Instruments and Gages.

OIL PRESSURE GAGE. Oil pressure should be between 30 and 50 pounds at normal operating engine speed and have 5 pounds of minimum pressure at idle speed. **CAUTION:** *Stop engine if oil pressure is too low for safe engine operation at any speed.*

Ammeters. Main ammeter should show a positive (+) charge for short period after starting engine, until generator restores to batteries current used in starting. Time will depend on condition of charge of batteries and electrical load carried. With batteries fully charged and regulator unit cut in, ammeter may show zero or only slight charge. "B" ammeter should show charge to indicate "B" battery is receiving current from generator. Stop engine and investigate discharge (-) readings with engine running and lights and accessories turned off.

VISCOMETER. With engine oil at normal operating temperature, indicator should remain in "ideal" range. If pointer remains in "heavy" range, inspect oil for dirt or sludge. If pointer goes to "thin" range, it may indicate oil dilution.

ENGINE TEMPERATURE GAGE. Reading should increase gradually during warm-up to normal operating temperature, about 160°F. **CAUTION:** *Do not move vehicle until engine temperature has reached 135°F. Maximum safe temperature 200°F.*

TACHOMETER. White pointer should indicate actual engine revolutions per minute at any given time. Red pointer indicates and remains at highest revolution per minute attained and should not exceed recommended governed engine speed, 2,400 revolutions per minute.

4. TO 5-TON 4x4 TRACTOR TRUCK (AUTOCAR MODEL U-7144T)

MAINTENANCE		
5,000- Mile (by month)	1,000- Mile (weekly)	
		<p>SPEEDOMETER. While vehicle is in motion, speedometer should register actual vehicle miles per hour, and odometer should record total accumulated mileage.</p> <p>FUEL GAGE. This gage should register approximate amount of fuel in tank at all times.</p> <p>AIR PRESSURE GAGE. Refer to item 2 for specifications and tests.</p>
4	4	<p>Horns, Mirrors, and Windshield Wipers. If tactical situation permits, test horns for proper operation and tone. Examine rear vision mirror and wipers to see if they are in good condition and secure. Test operation of wiper motors. Make sure that wiper blades contact glass evenly and operate through their full range without indications of loose wiper motor mountings. Adjust rear vision mirror for correct vision.</p>
5	5	<p>Brakes (Service and Parking, Braking Effect, Feel, Side Pull, Noise, Chatter, Pedal Travel, Hand Control). Operate brakes at various speeds during road test.</p> <p>SERVICE BRAKES. Apply foot pedal sufficiently to stop vehicle in minimum distance, and observe brake effectiveness, any pull to one side, unusual noise, or chatter. Pedal should depress with little effort, and should return to off position when released. Apply hand application valve to see if it functions without binding.</p> <p>PARKING BRAKE. Stop vehicle on reasonable incline. Apply parking brake, and observe if it holds vehicle effectively, that lever has at least one-half travel in reserve, and that ratchet and pawl latch the applied brake securely.</p>
6	6	<p>Clutch (Free Travel, Drag, Noise, Chatter, Grab, Slip). Pedal free travel should be 1½ inches before meeting resistance. Test clutch for drag when shifting into low gear. Clutch should stop transmission entirely, and shift should be made without clashing. Note any unusual noise when pedal is depressed which may indicate defective or dry release bearing.</p>

SECOND ECHELON PREVENTIVE MAINTENANCE

MAINTENANCE		
6,000- Mile (15 work)	1,000- Mile (250h- 15)	
		With transmission in gear, note any tendency to chatter or grab when clutch is engaged, or slippage when fully engaged under load. <i>NOTE: Never allow pedal free play to become less than three-fourths of an inch. Adjust only according to instructions in par. 59.</i>
7	7	Transmission and Transfer (Lever Action, De-clutching, Vibration, Noise). Levers should move into each gear range position easily and quietly. Test declutching lever to see that front axle engages properly. Note any vibration that may indicate loose mountings or noise that may indicate damaged, excessively worn, or inadequately lubricated parts.
8	8	Steering (Free Play, Bind, Wander, Shimmy, Side Pull, Column, and Wheel). With vehicle in motion, move steering wheel fully in both directions, and observe whether there is any indication of looseness or binding. Note any tendency to wander, shimmy, or pull to one side. Observe if steering column and wheel are in good condition and secure.
9	9	Engine (Idle, Acceleration, Power, Noise, and Governed Speed). Observe engine operating characteristics as follows: IDLE. Engine should idle smoothly without stalling. UNUSUAL NOISES. Listen for knocks and rattles as the engine is accelerated and decelerated, and while it is under both light and heavy loads. ACCELERATION AND POWER. Operate the engine at various speeds in all gear ratios, noting if the vehicle has normal pulling power and acceleration. Note any tendency to stall while shifting. A slight ping during fast acceleration is normal. Continued or heavy ping may indicate early timing, heavy accumulation of carbon, or low octane number fuel. GOVERNED SPEED. With the vehicle in a low gear, slowly depress the accelerator to the toeboard, and by observing the tachometer reading, note if the engine speed reaches but does not exceed the specified 2,400 revolutions per minute.

4. TO 5-TON 4x4 TRACTOR TRUCK (AUTOCAR MODEL U-7144T)

MAINTENANCE		
6,000- Mile (1st month)	1,000- Mile (month- ly)	
10	10	Unusual Noises (Attachments, Cab, Wheels). Be on the alert during road test for any noise that may indicate loose or damaged attachments mounted on vehicle, loose cab mountings, floor plates, doors, windshield, or hardware. Listen particularly for indications of loose wheel mountings.
12	12	Air Brake System Leaks. With the air pressure at the governed maximum and the brakes applied, stop the engine. There should not be a noticeable drop in pressure within 1 minute. If any pressure drop occurs during this check, test the air brake system for leaks by the soapsuds method.
13	13	Temperatures (Brake Drums, Hubs, Axles, Transmission, Transfer). Place hand cautiously on all brake drums and wheel hubs to see if they are abnormally hot. Inspect axle housings, transmission, and transfer case for indications of overheating.
14	14	Leaks (Engine Oil, Water, Fuel). Look in engine compartment, and under vehicle, for indications of engine oil, coolant, or fuel leaks. Trace any found to their source and correct or report them to proper authority.
MAINTENANCE OPERATIONS		
<i>Raise Vehicle - Block Safely</i>		
16	16	Gear Oil Level and Leaks (Axles, Transmission, and Transfer). Remove filler plugs in front and rear axles, transmission, and transfer case, and check lubricant levels. Proper level is from lower edge of filler hole to one-half inch below when hot. Allow sufficient time for foaming to subside before checking levels. Note condition of lubricant. If an oil change is due in any of these units, or condition of lubricant indicates an oil change is necessary, drain and refill units with fresh specified oil. Note any indications of excessive lubricant leaks at oil seals or gaskets.
17	17	Unusual Noises (Engine, Belts, Accessories, Transmission, Transfer, Shafts and Joints, Axles and Wheel Bearings). With engine running, observe as follows:

SECOND ECHELON PREVENTIVE MAINTENANCE

MAINTENANCE		
6,000- Mile (19 month)	1,000- Mile (1month- 15)	
		<p>ENGINE, BELTS, AND ACCESSORIES. Accelerate and decelerate the engine momentarily, and listen for any unusual noise in these units that might indicate damaged, loose, or excessively worn engine parts, drive belts, or accessories. Locate the noise, and correct or report to the proper authority, any unusual engine noise heard during the road test.</p> <p>TRANSMISSION, TRANSFER, PROPELLER SHAFTS AND JOINTS, AXLES, AND WHEEL BEARINGS. With the transmission in an intermediate gear, and front driving axle engaged, operate these units at a constant, moderate speed by use of the hand throttle. Listen for any unusual noise that might indicate damaged, loose, or excessively worn unit parts. Also observe all propeller shafts and wheels for vibrations and run-out, and for vibrations in the other units which may indicate looseness or unbalance. All of the driven wheels should rotate at approximately the same speed. Slow running wheels may indicate tight brakes or wheel bearings. Also be sure to locate, correct, or report to the proper authority any noise noted during road test.</p>
18	18	<p>Cylinder Heads and Gaskets. Look for cracks or indications of oil, coolant, or compression leaks around studs, cap screws, and gaskets. CAUTION: <i>Cylinder heads should not be tightened unless there is definite evidence of leaks. If tightening is necessary, use torque-indicating wrench, and tighten head nuts in the proper sequence and to 52½ foot-pounds tension.</i></p>
	19	<p>Valve Mechanism (Clearances, Cover Gaskets). Adjust valve stem clearance only if noisy; intake clearance is 0.006 inch (hot). Exhaust clearance is 0.010 inch (hot).</p>
19		<p>ADJUST. Set valve stem clearances to above specifications. Be sure valve stems, springs, seats and locks are in good condition, correctly assembled, and secure. Inspect valve covers to be sure they are in good condition. Reinstall them securely, using new gaskets if necessary.</p>

4- TO 5-TON 4 x 4 TRACTOR TRUCK (AUTOCAR MODEL U-71447)

MAINTENANCE		
6,000- Mile (1st rank)	1,000- Mile (2nd- 5th rank)	
22	22	Battery (Cables, Hold-down Frames, Carrier, Record Gravity, and Voltage). Inspect battery case for cracks and leaks. Clean top of battery. Inspect cables, terminals, bolts, posts, straps, and hold-down frames for good condition. Test specific gravity and voltage, and record on W.D. AGO Form No. 461. Specific gravity readings below 1.225 indicate battery should be recharged or replaced. Electrolyte level should extend three-eighths inch above separators.
22		Perform high-rate discharge test according to instructions for "condition" test which accompany test instrument and record voltage on W.D. AGO Form No. 461. Cell variation should not be more than 30 percent. <i>NOTE: Specific gravity must be above 1.225 to make this test.</i>
22	22	Bring electrolyte to proper level by adding distilled or clean water. Clean entire battery and carrier. Repaint carrier if corroded. Clean battery cable terminals, terminal bolts, and hold-down frames carefully to avoid damage to battery.
	20	Spark Plugs (Gaps, Deposits). Without removal, wipe off plugs and examine insulators for damage or indications of compression leaks.
20		Remove all plugs, and examine to see if they are in good condition. Pay particular attention to broken insulators, excessive carbon or oxide deposits, and to electrodes burned thin. Clean plugs thoroughly. If plug cleaner is not available, install new or reconditioned plugs. <i>NOTE: Do not install plugs until item 21 has been performed.</i> Set plug gaps to 0.025 inch by bending only grounded electrodes.
21		Compression Test. Test compression with all spark plugs removed. Compression pressure at cranking speed should not be below 85 pounds. There should not be more than a 10-pound variation between cylinders. Record compression pressures on space provided on back of work sheet, W.D. AGO Form No. 461.

SECOND ECHELON PREVENTIVE MAINTENANCE

MAINTENANCE		
1,000- Mile 110 month	1,500- Mile (month) or	
23	23	Crankcase (Leaks, Oil Level.) With engine idling, examine crankcase, valve covers, timing gear cover, and clutch housing for oil leaks. Stop engine, and after oil has drained into crankcase, check to see if it is up to proper level. If an oil change is due, or condition of oil indicates the necessity, drain crankcase and refill to correct level with fresh specified oil. NOTE: Do not start engine again until item 24 has been performed.
24	24	Oil Filters and Lines. Inspect filters and external engine oil lines to see if they are in good condition, secure, and not leaking. Remove filter body drain plugs, and drain off contents. Remove filter cartridge and check condition. If cartridge change is due, or condition indicates the necessity, replace with new cartridge, being sure gaskets are in place. Tighten covers and drain plugs securely.
25	25	Radiator (Core, Shell, Mountings, Hose, Cap and Gasket, Antifreeze Record, Overflow Pipe). Inspect all applicable items to see if they are in good condition, secure, and not leaking. Be sure overflow pipe is not kinked or clogged. Examine condition of coolant to see whether it is so contaminated that cooling system should be cleaned. If cleaning is necessary, proceed only according to current directives covering proper procedure, recommended cleaner, neutralizer, and inhibitor materials. Clean all insects, dirt, or grease deposits from core air passages, and inspect for bent cooling fins. CAUTION: Use only a suitably shaped piece of wood or blunt instrument to straighten fins. If antifreeze is in use, test its protective value, and record in space provided on back of work sheet W.D., AGO Form No. 461.
25		TIGHTEN. Carefully tighten all loose radiator mountings, water connections, and hose clamps.
26	26	Water Pump and Fan. Inspect pump to see if it is in good condition, secure, and not leaking. Examine shaft for end play or bearing looseness. Inspect fan to see if it is in good condition and that blades and hub are secure. Loosen drive belts and examine fan

4- TO 5-TON 4 x 4 TRACTOR TRUCK (AUTOCAR MODEL U-7144T)

Maintenance		
0,000- Mile Limit	1,000- Mile Interval	
		for hub or bearing wear. Leave drive belts loose until adjustment is made (item 29).
		TIGHTEN. Carefully tighten water pump and fan assembly and mounting nuts or screws. Tighten water pump packing gland nuts until they are just snug. CAUTION: <i>Overtightening of packing gland nuts will cause premature packing and shaft wear and result in leaks.</i>
27	27	Generator, Cranking Motor, and Switch. Inspect generator, cranking motor and cranking motor switch to see if they are in good condition, securely mounted, and if wiring connections are clean and secure.
27		Remove generator and cranking motor inspection covers. Examine commutators and brushes to see if they are in good condition and clean; if brushes are free in brush holders and have sufficient spring tension to hold them in proper contact with commutators; and if brush connection wires are secure and not chafing.
27		CLEAN. Blow out commutator end of generator and cranking motor with compressed air. If commutators are dirty, clean only with flint paper 2/0 (do not use emery). Place commutator over end of suitable sized piece of wood and again blow out with air.
27		TIGHTEN. Carefully tighten cranking motor mounting bolts.
28	28	Air Compressor (Unloader Valve, Governor, Lines). Examine the air compressor to see that it is in good condition, properly aligned with its drive pulleys, and secure. Check unloader valve for satisfactory valve clearance. Make sure the governor is in good condition and secure. Note if the compressor, water, oil, and air lines within engine compartment are in good condition and secure, and that oil and water lines do not leak.
		CLEAN. Clean governor hair air strainer in dry-cleaning solvent; dry, apply a thin film of engine oil to strainer and reinstall.

SECOND ÉCHELON PREVENTIVE MAINTENANCE

MAINTENANCE		
6,000 Mile (or month)	1,000- Mile (month- ly)	
		<p>SPECIAL LUBRICATION. Apply a few drops of engine oil on the unloader valve fulcrum pin. Apply a few drops of kerosene or dry-cleaning solvent on upper valve stem of governor.</p> <p>ADJUST. Adjust the unloader valve clearances 0.010 to 0.015 inch.</p>
29	29	<p>Drive Belts and Pulleys. Examine all drive belts for evidence of fraying condition, excessive wear, and deterioration. Inspect all drive pulleys and hubs to see if they are in good condition and securely mounted.</p> <p>ADJUST. Set adjustment so that drive belts have $\frac{1}{2}$- to $\frac{3}{8}$-inch finger-pressure deflection.</p>
30	30	<p>Tachometer Drive and Adapter. Note if they are in good condition, correctly assembled, and secure. Inspect the flexible drive shaft for kinks, and the connection for indications of oil leaks.</p>
31	31	<p>Distributor (Cap, Rotor, Points, Shaft, Advance Units). Observe if distributor body and external attachment are in good condition and secure. Examine other parts as follows:</p> <p>CAP, ROTOR, AND POINTS. Clean dirt from cap and remove. Inspect cap, rotor, and breaker plate to see if they are in good condition, secure, and serviceably clean. Pay particular attention to cracks in cap and rotor, corrosion of terminals and connections, and to burned rotor bar or contact points. See that points are well aligned and adjusted to 0.020 inch, when wide open.</p> <p>If inside of distributor is dirty, remove assembly, clean in dry-cleaning solvent, dry thoroughly with compressed air, and lubricate its friction parts very lightly. When cleaning, remove wick and lubrication cup; clean, recock, and replace them after cleaning the distributor. If breaker points are pitted, burned, or worn to an unserviceable degree, replace them. Also replace condenser if points are burned, as this may be the cause. When cleaning points, use fine file or flint paper 2/0 (never use emery), and blow out filings with compressed air.</p>

4- TO 5-TON 4 x 4 TRACTOR TRUCK (AUTOCAR MODEL U-7144T)

MAINTENANCE		
6,000- Mile Interval	1,000- Mile Interval	
		SHAFT. Test shaft by hand-feel for excessive wear in shaft or bushings.
		CENTRIFUGAL ADVANCE. Install rotor on shaft, and test distributor governor by finger force for normal range of movement permitted by mechanism. Note if it will return to original position when released without hang-up or binding.
31	31	SPECIAL LUBRICATION. Lubricate cam surfaces, breaker arm pin, and wick according to instructions in Lubrication Guide.
31		ADJUST. Set breaker point gaps to 0.020 inch.
32	32	Coil and Wiring. Inspect coil, ignition wiring, including shielding of conduits, to see if they are in good condition, clean, securely connected, and properly mounted. Inspect all low voltage wiring in engine compartment in like manner.
33	33	Manifolds and Gaskets. Inspect for looseness, damage, or exhaust leaks at gaskets. Examine for evidence of cracks or sand holes, usually indicated by carbon streaks.
33		TIGHTEN. Carefully tighten all manifold assembly and mounting nuts.
34	34	Air Cleaner. Inspect carburetor air cleaner to see if it is in good condition, securely mounted and connected, and not leaking. Remove reservoir and element, clean in dry-cleaning solvent, and dry. Fill reservoir to proper level with clean or used engine oil, and reassemble. Be sure gaskets are in place and all joints and air horn connections tight.
35	35	Breather Cap. Inspect crankcase breather cap to see if it is in good condition, secure, and not leaking. Remove oil reservoir and element, and wash clean in dry-cleaning solvent. Refill reservoir with fresh engine oil, and reassemble securely.
36	36	Carburetor (Choke, Throttle, Linkage, and Governor). Note if these items are in good condition, correctly assembled, and securely installed. Make sure the carburetor does not leak and that the control linkage, including choke and throttle shaft, is not

SECOND ECHELON PREVENTIVE MAINTENANCE

MAINTENANCE		
6,000- Mile Cycle monthly	1,000- Mile 1 month- ly	
		excessively worn. Observe if choke valve opens fully when the control is in its released position, if throttle valve opens fully when the accelerator is fully depressed, and if the governor is secure and properly sealed.
37	37	Fuel Filter and Lines. Examine filter to see if it is in good condition, securely mounted and connected, and not leaking. CLEAN. Close fuel shut-off valve, and remove filter sediment bowl and element. Wash clean in dry-cleaning solvent and reassemble securely, being sure gaskets are in place. CAUTION: If element cannot be cleaned by washing, replace unit. Do not scrape element to clean. Turn on fuel supply, and recheck for leaks.
38	38	Fuel Pump (Pressure). Inspect pump to see if it is in good condition, securely mounted, and not leaking. Remove sediment bowl and screen, and wash to dry cleaning solvent. Be sure gasket is in place and serviceable when bowl is reinstalled.
38		Attach a test gage to pressure side of fuel pump, and after starting engine in item 39, see that pressure is satisfactory. The pressure should be 2 pounds minimum and 3 $\frac{3}{4}$ pounds maximum, at idle speed.
39	39	Starter (Action, Noise, Speed). Start the engine, and observe if general action of cranking motor is satisfactory. Be particularly sure that it engages and operates properly without excessive noise, has adequate cranking speed, and if the engine starts readily. Also, as soon as engine starts, note whether oil pressure gage and ammeter indications are satisfactory.
40	40	Leaks (Engine Oil, Fuel, and Water). With engine running, recheck all points of oil, fuel, and cooling systems for leaks. Trace any leaks found to source, and correct or report them to proper authority.
41	41	Ignition Timing (Advance). With engine running and a neon timing light connected, observe if ignition timing is correct. Also note whether automatic con-

4- TO 5-TON 4 x 4 TRACTOR TRUCK (AUTOCAR MODEL U-7144T)

MAINTENANCE		
5,000- Mile (Six Months)	1,000- Mile (Month- ly)	
		trois advance the timing as engine is accelerated gradually.
41		ADJUST. Adjust ignition timing to specifications in paragraph 82.
42	42	Engine Idle and Vacuum Test. Inspect as follows: ADJUST. Connect a vacuum gage to intake manifold, adjust engine to its normal idle speed by means of throttle stop screw, and adjust the idle mixture adjusting needle until vacuum gage indicates a steady maximum reading. If these latter adjustments are made simultaneously, time will be saved.
42	42	VACUUM TEST. With the engine running at normal idling speed, vacuum gage should read about 18 to 21 inches, and pointer should be steady. A needle fluctuating between 10 and 15 inches may indicate a defective cylinder head gasket or valve. An extremely low reading may indicate a leak in intake manifold or gasket. Accelerate and decelerate engine quickly. If vacuum gage indicator fails to drop to approximately 2 inches as throttle is opened, and then fails to recoil to at least 24 inches as throttle is closed, it may be an indication of diluted oil, poor piston-ring sealing, or abnormal restriction in carburetor, air cleaner, or exhaust. NOTE: Above readings apply to sea level. There will be approximately a 1-inch drop for each 1,000 feet of altitude.
43	43	Regulator Unit (Connections, Voltage, Current, and Cut-out). Inspect regulator unit to see if it is in good condition, securely mounted and connected, and clean.
43		TEST. Connect a low voltage circuit tester, and observe if voltage regulator, current regulator, and cut-out control the generator output properly. Follow instructions in vehicle manual, or those which accompany test instrument. Replace if test shows faulty operation. CAUTION: This test should be made only after regulator unit has reached normal operating temperature.
44	44	Power Tire Inflation (Connection, Line). Inspect tire inflation connection at reserve tank to see that

SECOND ECHELON PREVENTIVE MAINTENANCE

MAINTENANCE		
6,000-Mile (Six months)	1,000-Mile (Monthly)	
47	47	<p>it is in good condition and clean. Be sure cap is present and connected by safety chain. Note whether valve turns easily and is not excessively worn. Examine air hose for deterioration, and check for damage or clogging. Connect hose, and test system for proper function when performing item 47.</p> <p>Tires and Rims (Valve Stems and Caps, Condition, Direction, Matching Spare Carrier). Inspect as follows:</p> <p>VALVE STEMS AND CAPS. Observe if all valve stems are in good condition and in correct position, and if all valve caps are present and installed securely. CAUTION: <i>Do not tighten with pliers.</i></p> <p>CONDITION. Examine all tires for cuts, bruises, breaks, and blisters. Remove embedded glass, nails, and stones. Look for irregular tread wear, watching for any sign of flat spots, cupping, feather edges, and one-sided wear. Remove tires worn thin at center of tread (or other unserviceable tires), and exchange for new or retreaded tires. Any mechanical deficiencies causing such conditions should be determined and corrected, or reported to proper authority. Wheel positions of tires with irregular wear should be changed to even up wear. Front tires, worn irregularly, should be moved to rear wheel positions.</p> <p>DIRECTION. Directional tires and non directional tires should not be installed on same vehicle. Directional tires on rear wheels should be mounted so that the "V" chevron will point down when viewed from the front. Directional tires on all front wheels will ordinarily be mounted so that "V" of chevrons will point up when viewed from front of vehicle.</p> <p>MATCHING. Inspect properly inflated tires to see if they are matched according to over-all circumference and type of tread.</p> <p>SPARE TIRE CARRIERS. See whether spare tire carriers are in good condition and secure.</p> <p>RIMS. All rims and their lock rings or flanges should be in good condition and secure.</p>

4. TO 5-TON 4x4 TRACTOR TRUCK (AUTOCAR MODEL U-7144T)

MAINTENANCE		
6,000- Mile Interval (monthly)	3,000- Mile Interval (bi-monthly)	
	47	TIGHTEN. Tighten all wheel rim flange or lug nuts securely.
47		SERVE. With tires properly inflated to 65 pounds (cool), check over-all circumference of all tires including spares. Select tires to be mounted on duals or on driving axles, so they will not have differences in over-all circumference exceeding the $\frac{3}{4}$ -inch limits specified in current directives and bulletins. Mount all dual tires with the larger tire outside. The valve stem on inner wheels should point out; the valve stem on outer wheels should point in, and should be opposite each other. NOTE: <i>Spares must be matched properly and mounted for use on one of the road wheels at intervals not exceeding 90 days. A convenient time to do this is during these maintenance services.</i> CAUTION: <i>After performing the tire-matching service, do not reinstall wheels until wheel bearing services are completed.</i>
48		Rear Brakes (Drums, Supports, Cams and Shafts). Inspect and service as follows: Remove rear wheels. NOTE: <i>On 6,000-mile maintenance, several wheel bearing and brake items up to 52 are group services and overlap. Perform in best order for economy of time and orderly reassembly.</i> DRUMS AND SUPPORTS. Clean dirt and grease from drums and supports (dust shields), keeping dry-cleaning solvent away from linings. Examine drums and supports to see if they are in good condition, securely mounted, and if drums are excessively worn or scored. CAMS AND SHAFTS. Note if cams and shafts are excessively worn where they contact. Also note if camshafts operate freely in collar and if shafts and collars are worn. TIGHTEN. Tighten brake support cap screws and hub to drum nuts securely.

SECOND ECHELON PREVENTIVE MAINTENANCE

MAINTENANCE		
6,000-Mile (six months)	1,000-Mile (month)	
	49	<p>Rear Brake Shoes (Linings, Anchors, Springs). Examine linings through inspection holes to see if they are so worn rivet heads may contact drums within next 1,000 miles of operation. If vehicle has been operated in deep water, mud, or loose sand, remove right rear wheel, and examine lining for damage. If this lining must be replaced, remove all wheels, check their brakes, and service as necessary, being sure to clean, lubricate, and adjust all removed wheel bearings as described in item 52 below for 6,000-mile service.</p>
49		<p>ADJUST. Adjust shoes by minor method if necessary. Remove rear wheels, and inspect linings to see if they are in good condition, tightly secured to brake shoes, in good wearing contact with drums, free of dirt or lubricant, and not excessively worn. Also see if shoes are in good condition, properly secured to anchors, guides, and retracting springs, and that springs have sufficient tension to return shoes properly to released position. Thickness of lining at most worn point should be enough for at least 1,000 miles of service before rivet heads are likely to contact drums.</p> <p>CLEAN. Clean all dirt and grease from linings with wire brush, cloth, or compressed air.</p> <p>ADJUST. After subsequent related items to 60 inclusive are completed, adjust shoes by minor method. If new linings have been installed, adjust by major method described in paragraph 126. Adjust slack adjusters so diaphragm push-rod travel is at minimum as described in paragraph 12b.</p>
52	52	<p>Rear Wheels (Bearings, Seals, Drive Flanges, and Nuts). Inspect and service as follows:</p>
	52	<p>WHEELS. Inspect wheels to see if they are in good condition and secure.</p> <p>BEARINGS AND SEALS. Check for looseness of wheel bearing adjustment. Revolve wheels, and listen for evidence of dry or damaged bearings. Inspect around flanges and brake supports for lubricant leaks.</p>

4- TO 5-TON 4 x 4 TRACTOR TRUCK (AUTOCAR MODEL U-7144T)

MAINTENANCE		
4,000- Mile (Two months)	1,000- Mile (Within 30)	
		DRIVE FLANGES AND NUTS. Note if they are in good condition and if nuts are tightened securely.
52		CLEAN. Disassemble rear wheel bearings and oil seals. Clean thoroughly in dry-cleaning solvent. Examine bearing cups and cones to see if they are in good condition, if machined surfaces they contact are in good condition, and if there is any excessive wear.
52		SPECIAL LUBRICATION. When all of the related items are to the point where wheel bearings are to be reinstalled, lubricate bearings as follows: Be sure all parts are clean and dry, the hands clean, and use clean lubricant. The inside of the wheel hub, the hub cap or hub flange, and the outside of spindle or axle shall be covered with 1/16 inch of lubricant to retard rusting. Bearing shall be either machine-packed or hand-packed by kneading lubricant into all spaces in the bearings. Coat the cups or outer races and the lips of the oil seals with lubricants, and install new lubricant retainer seals if necessary. CAUTION: Do not pack the large cavity in wheel hubs between wheel bearings with lubricant. It will cause leakage past the seals.
52		ADJUST After lubricating wheel bearings, reassemble hub and drum assemblies into place. Adjust wheel bearings correctly (par. 134).
	53	Front Brakes (Drums, Supports, Cams and Shafts, Hoses, Air Chambers, Push Rods and Seals, Slack Adjusters). Inspect brake hose, chambers, push rods and seals, and slack adjusters to see if they are in good condition, correctly assembled, and secure.
	53	Remove front wheels; inspect and service as follows: DRUMS AND SUPPORTS. Clean and inspect in same manner as in item 48. CAMS AND SHAFTS. Inspect in same manner as in item 48.
	54	Front Brake Shoes (Linings, Anchors, Springs). Inspect in same manner as in item 49.

SECOND ECHELON PREVENTIVE MAINTENANCE

MAINTENANCE		
6,000- Mile Lub. month	1,000- Mile Lub. Mth.	
		ADJUST. Adjust by minor method if necessary.
54		Remove front wheels, and inspect shoes, linings, anchors, and springs in same manner as in item 49 at 6,000-mile service.
		CLEAN. Clean in same manner as in item 49.
54	54	ADJUST. Adjust in same manner as in item 49 after subsequent related items to 50 inclusive are completed.
55	55	Steering Knuckles (Joints, Bearings, Seals). Inspect to see if knuckle housings are in good condition. Look particularly for cracks around steering arms. See if outside knuckle felt seals and seal flanges are in good condition and secure. Remove lubrication plug, and examine sample of lubricant to see if it is contaminated.
55		CLEAN. Remove constant velocity universal joint assembly. Wash thoroughly in dry-cleaning solvent without disassembly of universal joint. Inspect parts to see if they are in good condition and not excessively worn. Pay particular attention to universal joint washers, balls and races, axle splines, flanges, and pivot bearings or bushings.
55		SPECIAL LUBRICATION. Pack new lubricant well into constant velocity universal joint until it fills all space between balls, cages, and races. Reassemble steering knuckle, taking care to replace any serviceable lubricant retainer seals, boots, or gaskets.
55		ADJUST. Use every precaution to reinstall shims and spacers in the original position from which they were removed at disassembly to insure correct pivot bearing and axle end-play adjustment.
56	56	Front Springs (Clips, Leaves, U-bolts, Hangers, and Shackles). Make sure these items are in good condition, correctly assembled, and secure. Spring clips and bolts must be in place. Spring leaves must not be shifted out of their correct position. This may be an indication of a sheared center bolt. Note if deflection of both springs is normal and approximately the same. Test hangers and bolts for excessive wear by means of a pry bar.

4- TO 5-TON 4 x 4 TRACTOR TRUCK (AUTOCAR MODEL U-7144T)

MAINTENANCE		
5,000- Mile (100 work)	1,000- Mile (monthly)	
		TIGHTEN. Tighten all spring U-bolts securely and uniformly.
57	57	Steering (Arms, Tie Rods, Drag Link, Seals and Boots, Pitman Arm, Gear, Column and Wheel). Make sure these items are in good condition, correctly and securely assembled and mounted, if steering gear case is leaking lubricant, and if lubricant is at proper level. Pay particular attention to Pitman arm to see if it is securely mounted and not bent out of its normal shape. Also observe if steering system is in good adjustment.
57		TIGHTEN. Tighten Pitman arm shaft nut securely. Also tighten steering gear case assembly and mounting nuts or screws, taking care not to disturb adjusting screws and lock nuts. CAUTION: Loosen steering column bracket when tightening steering case mounting nuts, so as not to distort column.
58	58	Front Shock Absorbers and Links. Observe bodies to make sure they are in good condition, secured to frame, and not leaking. Also make sure that links are secure and not damaged. If rubber bushings are hard or cracked, apply brake fluid to exposed surfaces.
58		SPRUE. Fill shock absorber bodies with specified fluid. Work arm several times and add more fluid. Repeat operation until all air is expelled and reservoir is full. Then disconnect link, and observe if action is normal. When arm is moved by hand, there should be resistance both ways.
60	60	Front Wheels (Bearings, Seals, Flanges, Axle End Play, and Nuts). Inspect front wheels, bearings, seals, drive flanges, and nuts in same manner as in item 52 for similar rear wheel items.
60		CLEAN. Disassemble, clean, and inspect the front wheel bearings and oil seals in the same manner as described in item 52. Be sure to check the universal joint end play as the drive flanges are removed, so that the end play adjustment may be made conveniently when reassembling.
60		SPECIAL LUBRICATION. Apply in same manner as described in item 52.

SECOND ECHELON PREVENTIVE MAINTENANCE

MAINTENANCE		
5,000- Mile (160 month)	1,000- Mile (3000- lyr)	
60		ADJUST. Adjust wheel bearings in same manner as described in item 52, and adjust brake shoes as described in item 49.
61	61	Front Axle (Pinion End Play, Seal, Vent, and Alignment). If front axle appears to be out of line, measure distance from front spring eye bolt to center of axle spring pad on each side. Distance should be equal. Inspect axle housing to see if it is in good condition and not leaking. Examine pinion shaft for excessive end play; examine seal for leaks. CLEAN. Clean axle housing vent thoroughly.
62	62	Front Propeller Shaft (Joints, Alignment, Seals, and Flanges). Make sure these items are in good condition, correctly and securely assembled and mounted. Be sure the universal joints are properly aligned with each other and are not excessively worn, that the slip joint is free, not excessively worn, and well lubricated, and that the seals on the universal joints and slip joint do not leak.
62		TIGHTEN. Tighten all universal joint assembly and companion flange bolts securely.
63	63	Engine (Mountings, Ground Strap, Side Parts). These items should be in good condition and securely mounted and connected. Be sure to examine both front and rear engine mountings and to see, on rubber mountings, that rubber is not separating from its metal backing. If mounting bolts are loose, tighten them properly, taking care not to overtighten. Remove oil or grease from rubber mountings. Apply a film of brake fluid if rubber is hard or cracking.
64	64	Hand Brake (Ratchet and Pawl, Linkage, Disk, and Lining). Examine to see if ratchet, pawl, and linkage are in good condition, secure and not excessively worn, that disk is not scored or oily, and that lining is not oil-soaked or worn too thin.
64		ADJUST. Set clearances between brake disk and lining to $\frac{1}{16}$ inch when brake lever is released.
65	65	Clutch Pedal (Free Travel, Linkage, Return Spring). Check pedal free travel, which must be

4- TO 5-TON 4 x 4 TRACTOR TRUCK (AUTOCAR MODEL U-7144T)

MAINTENANCE		
5,000- Mile (110 hours)	1,000- Mile (30 hours)	
		1½ inches before meeting resistance. Examine to see if pedal is securely mounted to shaft, if clutch operating linkage is in good condition, secure, and not excessively worn at friction joints. See if return spring has proper tension to bring pedal to correct released position.
65		ADJUST. Adjust plate so clutch pedal free travel is to 1½ inches. CAUTION: <i>No pedal adjustment should be made; for correct procedure, see paragraph 59.</i>
66	66	Brake Pedal (Linkage and Return Spring). Pedal should operate easily. Inspect all linkage to see if it is in good condition, securely connected, and not excessively worn at friction joints. Be sure return spring has tension to bring pedal to correct released position.
69	69	Air Brake Application Valve. See if application valve and linkage are in good condition, correctly assembled, and secure, and that valve closes fully when brake pedal is released.
70	70	Air Brake Reservoirs. Observe whether they are in good condition and secure. Open the drain cocks, and drain off condensation.
71	71	Transmission (Mountings, Seals, Linkage). Note if transmission case is in good condition and securely mounted. Inspect for lubricant leaks at seals and gaskets. Examine control linkage and shift mechanism for damage or excessive wear.
72	72	Transfer (Mountings, Linkage, Seals, Vent). Make sure case is in good condition, securely mounted, that transmission and declutching control linkage and shift mechanism is securely connected and not damaged, and if the vent is open. Look for evidence of lubrication leaks at seals and gaskets. Clean vent passage if clogged.
72		TIGHTEN. Draw up all external assembly and mounting nuts securely.
73	73	Rear Propeller Shaft. Inspect in same manner as in item 62.

SECOND ECHELON PREVENTIVE MAINTENANCE

MAINTENANCE		
6,000- Mile (6-4464)	1,000- Mile (1 month- (6)	
		TIGHTEN. Draw up all universal joint and companion flange bolts securely.
75	75	Rear Axle (Pinion End Play, Seals, Vent, and Alignment). Inspect in the same manner as in item 61 for front axle. CLEAN. Clean axle housing vent thoroughly.
76	76	Rear Air Brakes (Chambers, Rods, Seals, and Slack Adjusters). See if all items are in good condition, securely connected, and mounted. Examine rods for excessive wear; examine seals for lubricant leaks.
77	77	Rear Springs (Clips, Leaves, U-bolts). Inspect and tighten in same manner as in item 56.
78	78	Rear Shock Absorbers and Links. Inspect in same manner as in item 58.
78	78	SERVZ. Service and make operating check in same manner as in item 58.
79	79	Cab Mountings. Note if they are all in good condition and secure. On cab mountings using coil springs, be sure springs are in good condition and properly compressed. These springs should be neither loose nor compressed until solid. TIGHTEN. Tighten cab mounting bolts securely, taking care to loosen the steering column clamp before tightening. When tightening spring-loaded mounting bolts, do not compress springs fully. After completing this service, be sure to tighten steering column clamp.
80	80	Frame (Side and Cross Members). Inspect frame, brackets, side rails, and crossmembers to see if they are in good condition, secure, and correctly aligned. If the frame is out of line, report condition to proper authority.
81	81	Wiring, Conduit, and Grommets. Observe these items underneath the vehicle, to see if they are in good condition, properly supported, connected, and secure.
82	82	Fuel Tank, Fittings, and Lines. Inspect fuel tank to see if it is in good condition and securely mounted.

4. TO 5-TON 4 x 4 TRACTOR TRUCK (AUTOCAR MODEL U-7144T)

MAINTENANCE		
6,000- Mile 100 month	1,000- Mile 1000th- hr	
		Examine cap for defective gasket or plugged vent. Remove strainer and clean thoroughly. See that filler neck is in good condition and that cap fits securely.
82		Remove fuel tank drain plug, and drain off accumulated water and dirt in bottom of tank. Drain only until fuel runs clear. Use necessary precautions against fire.
83	83	Brake Lines (Fittings and Hoses). Examine all lines and fittings and air brake hose under vehicle, to see if they are in good condition, securely connected, and supported so that lines or hose will not chafe against other vehicle parts.
84	84	Exhaust Pipes and Muffler. Examine exhaust pipe to see if it is securely attached to exhaust manifold, that gasket or packing does not show visible evidence of leakage, and that the other end is clamped securely to muffler. Inspect muffler to see if it is in good condition and securely mounted. Check tail pipe to see if it is securely clamped to muffler, properly supported, and unobstructed at its outer end. See that drain holes in muffler are at lowest point and not clogged.
85	85	Vehicle Lubrication. If due, lubricate in accordance with Lubrication Guide (par 17), and current lubrication directives, using only clean lubricant and omitting items that have had special lubrication during this service. Replace damaged or missing fittings, vents, flexible lines, or plugs.
		LOWER VEHICLE TO GROUND
86	86	Toe-in and Turning Stops. With front wheels on ground and in straight-ahead position, use a toe-in gage to determine if adjustment is as specified. The gage should read from $\frac{3}{16}$ to $\frac{5}{16}$ inch. Turn wheels fully in both directions, and see if turn is limited by stops. In this position, note if tires clear all parts of vehicle. If there is any indication turning angle exceeds specified limits (inside wheel 28 degrees, outside wheel 24 degrees) such as loose wheel stops, scuffing of tires against vehicle, or abnormal front

SECOND ECHELON PREVENTIVE MAINTENANCE

MAINTENANCE		
6,000 Mile (or month)	1,000 Mile (month- ly)	
		drive universal joint wear, report for check of turning angle by higher echelon.
87	87	Winch (Clutch, Drive, Shear Pin, Cable). Observe whether all items are in good condition, correctly assembled, and secure. See that clutch moves freely and latches securely. Inspect propeller shaft in same manner as in item 62, and see that proper shear pin is installed. Propeller shaft front yoke should slide freely on worm shaft to insure safety feature of shear pin. Check safety collar clearance on shaft. Inspect cable to see that it is in good condition, evenly wound, and note whether cable chain and hook are securely attached. Lubricate winch clutch, shaft on which it slides, and operating arm, moving clutch back and forth to be sure it is free.
87		CLEAN AND SERVE. Unwind cable, and inspect for broken or frayed strands and for flat or rusty spots. Clean entire length of cable with cloth saturated with very thin oil or kerosene. Remove excess, and as cable is rewound evenly on drum, apply a thin film of engine or gear oil. Sample oil in worm gear housing for contamination. If oil change is due, or condition of oil warrants, drain and refill with specified oil.
88	88	Fifth Wheel (Bed Plate and Bolts). Observe fifth wheel rocker plate and bed plate to see if they are in good condition, securely assembled, and mounted. Examine kingpin lock to see that it operates properly, locks securely, and that kingpin latch is not excessively worn. TIGHTEN. Tighten all assembly and mounting bolts. SPECIAL LUBRICATION. Clean fifth wheel plate and lubricate with chassis lubricant. Lubricate all fifth wheel assembly grease fittings. Also hand-pack lubricant into latching mechanism. CAUTION: <i>When a trailer is not attached, the fifth wheel should be covered to prevent accumulation of dirt.</i>

4. TO 5-TON 4 x 4 TRACTOR TRUCK (AUTOCAR MODEL U-7144T)

MAINTENANCE		
6,000- Mile Int. (month)	1,000- Mile Cont'd. (5)	
89	89	Tractor-to-trailer Brake Hose and Connections. Examine brake hose to see if they are in good condition, properly supported, if connecting fittings are in good condition, and not excessively worn.
91	91	Lamps (Lights) (Head, Tail, Body, Stop, and Blackout). Operate all switches and note if lights respond. Include stop and blackout lights. Make sure if foot switch controls headlight beams properly, and if beams are aimed so as not to blind oncoming traffic. Examine all lights to see if they are in good condition and securely mounted. Note whether lenses are dirty or reflectors discolored.
91		ADJUST. Adjust lamp-unit beams.
92	92	Safety Reflectors. See if reflectors are all present, in good condition, clean, and secure.
93	93	Front Bumper, Tow Hooks, Brush Guards, and Grille. See if these items are in good condition, secure, and that radiator grille is not obstructed.
94	94	Hood and Fasteners. Inspect engine hood (cover) in cab to see if it is in good condition and that fasteners operate properly and hold hood securely.
95	95	Front Fenders and Running Boards. Examine fenders, running boards, and steps to cab to see if they are in good condition and securely mounted.
96	96	Cab (Doors, Hardware, Windshield and Glass, Top and Frame, Side Curtains, Seats, Gun Racks, Grab Rails, Floor Boards, Ventilators, Platforms). Inspect these items to see if they are in good condition and secure, that the hardware and ventilators operate properly, and are adequately lubricated. Be sure that the doors engage their bumpers and strikers and latch properly in the closed position. Make sure that the doors are properly lined with their openings. Be sure wood platforms over gas tank and rear of cab are securely bolted and not damaged.
98	98	Circuit Breakers. Observe if they are in good condition, clean, dry, and securely connected and mounted.

SECOND ECHELON PREVENTIVE MAINTENANCE

MAINTENANCE		
5,000-Mile (or month)	1,000-Mile (or week)	
99	99	Rear Splash Guards. Note that they are in good condition and securely mounted.
101	101	Pintle Hook. Examine pintle to see if it is in good condition and securely mounted to frame. Test pintle and latch to see if they operate properly, are adequately lubricated, and that lock pin is present and securely attached by chain. Look especially for broken spring or worn drawbar.
103	103	Paint and Markings. Examine paint of entire vehicle to see if it is in good condition, paying particular attention to any bright spots in finish that might cause glare or reflection. Inspect vehicle markings and identification for legibility. Include identification plates and their mountings if furnished.
104	104	Radio Bonding (Suppressors, Filters, Condensers, and Shielding). See if their bonding connections are in good condition, clean and secure, and note if all items are securely mounted. <i>NOTE: Any irregularities, except those that can be corrected by cleaning and tightening, should be reported to signal corps personnel.</i>
TOOLS AND EQUIPMENT		
131	131	Tools (Vehicle and Pioneer). Inspect standard vehicle and pioneer tools to see if they are all present (see vehicle stowage list), in good condition, clean, and properly stowed or securely mounted. Inspect tool box to see if it is in good condition and securely mounted and locked. Also examine tools which have cutting edges to see that they are sharp. Any tools mounted on outside of vehicle which have bright or polished surfaces, should be painted or otherwise treated to prevent rust, glare, or reflection.
132	132	Fire Extinguisher. Be sure extinguisher is in good condition, securely mounted, and fully charged. The charge may be determined on gas-type extinguishers by weighing with a scale, and on liquid-type by shaking. Also be sure nozzles are free from corrosion.

4- TO 5-TON 4 x 4 TRACTOR TRUCK (AUTOCAR MODEL U-7144T)

MAINTENANCE		
6,000- Mile (in month)	1,000- Mile (month- ly)	
133	133	Decontaminator. See if decontaminator is in good condition, securely mounted, and fully charged. Make the latter check by removing filler plug. <i>NOTE: This solution must be replaced every 3 months as it deteriorates.</i>
134	134	First-aid Kit (If Specified). See if it is in good condition, and that all of its items are present and properly packed. Report any deficiencies immediately to proper authority.
135	135	Publications and Form No. 26. Check to see whether vehicle manuals, Lubrication Guide, Standard Form No. 26 Driver's Report-Accident, Motor Transportation, and MWO and Major Unit Assembly Replacement Record W.D., AGO Form No. 478 are present, legible, and properly stowed.
136	136	Traction Devices (Chains). Examine tire chains to be sure they are in good condition, clean (if not in use), not excessively worn, protected against rust, and properly mounted or stowed.
137	137	Tow (Chains, Cables, Rope, Snatch Blocks). See if the provided towing devices are in good condition, clean, and properly stowed. Tow chains or cables should be properly protected against rust when not in use. If snatch blocks are furnished, check to see that they operate freely.
139	139	Fuel and Water Cans and Brackets. Observe if they are in good condition and secure. Note if the caps fit tightly, if they are secured to the can with a chain, and if cans are leaking.
141	141	Modification (Work Orders Completed). Inspect vehicle to determine that all Modification Work Orders have been properly completed, and entered on W.D., AGO Form No. 478. Enter any replacement of major unit assembly made at time of this service.
142	142	Final Road Test. Make a final road test rechecking items 2 to 15 inclusive, and also be sure to recheck the transmission, transfer case, and all driving

ORGANIZATION TOOLS AND EQUIPMENT

MAINTENANCE	
0,000- Mile (six months)	1,000- Mile (monthly)

axles to see that the lubricant is at the correct level and not leaking. Confine this road test to the minimum distance necessary to make satisfactory observations. **NOTE:** *Correct or report all deficiencies found during final road test.* **CAUTION:** *Be sure all inspection plates on cab floor and under fenders are replaced and securely fastened.*

Section XI

ORGANIZATION TOOLS AND EQUIPMENT

23. TOOL SETS.

a. **Standard Tool Sets.** The tool sets available to individuals (specialists) and organizations, dependent upon the allocation in the tables of equipment are listed in SNL N-19. The components of these tool sets are also listed and illustrated.

b. **Special Tool Set.** The special tools available for organizational maintenance establishments are listed in the Organizational Spare Parts and Equipment List of SNL G-510.

Section XII

TROUBLE SHOOTING

24. GENERAL.

a. This section contains trouble shooting information and tests which can be made to help determine the causes of some of the troubles that may develop in trucks used under average climatic conditions (above 32°F.). Each symptom of trouble given under the individual unit or system is followed by a list of possible causes of the trouble. The tests necessary to determine which one of the possible causes is responsible for the trouble are explained after each possible cause.

25. ENGINE.

a. **Engine Will Not Turn.**

(1) **HYDROSTATIC LOCK OR SEIZURE.** Remove spark plugs (par. 83) and attempt to turn engine with hand crank to check for excess fuel or oil in cylinders. If engine turns, the lock will be relieved. If engine will not turn, test for jammed cranking motor throw-out mechanism (step (2), following).

4- TO 5-TON 4 x 4 TRACTOR TRUCK (AUTOCAR MODEL U-71441)

(2) **CRANKING MOTOR THROW-OUT MECHANISM JAMMED.** Remove cranking motor (par. 89). Clean grease and dirt from throw-out mechanism. Inspect mechanism for broken parts, repair, and install cranking motor. If engine still will not turn, notify higher authority.

(3) **INCORRECT OIL VISCOSITY.** Drain crankcase and refill with proper grade oil (par. 17).

b. Engine Turns But Will Not Start.

(1) **INOPERATIVE FUEL SYSTEM.** Remove fuel line from carburetor. With ignition switch "OFF," turn engine over with the cranking motor. If fuel does not flow freely, it is not reaching carburetor. If fuel flows freely, trouble is in carburetor. Repair or replace faulty carburetor (par. 62).

(2) **INOPERATIVE IGNITION SYSTEM.** Remove a cable from a spark plug. Turn ignition switch to "ON." Hold spark plug cable terminal one-quarter inch from engine casting, and crank engine. If spark does not jump the ¼-inch gap, the ignition is inadequate (par. 83).

(3) **SLOW CRANKING SPEED** (pars. 31 and 89).

c. Engine Does Not Develop Full Power.

(1) **IMPROPER IGNITION** (par. 30).

(2) **ENGINE OVERHEATED** (par. 29).

(3) **IMPROPER VALVE ADJUSTMENT.** Check clearance, and adjust if necessary.

(4) **USE OF IMPROPER TYPE OF FUEL.** Change to fuel of correct specifications.

(5) **PREIGNITION.** If proper octane fuel is being used and the ignition system is functioning satisfactorily, spark plug or improper heat range may be the cause of the trouble (pars. 30 and 29). Otherwise notify higher authority.

(6) **AIR LEAKS AT CARBURETOR OR MANIFOLD FLANGES.** With engine running at 800 revolutions per minute, apply a small amount of oil at carburetor and manifold flange gaskets. If oil is sucked in, there is a leak. If leak persists after tightening flange bolt nuts, replace gaskets.

(7) **LOW ENGINE COMPRESSION OR IMPROPER VALVE TIMING.** If the engine does not develop full power with fuel reaching combustion chambers, adequate ignition, and the proper grade and quantity of oil in crankcase, low compression, or improper valve timing is indicated. Notify higher authority.

(8) **INCORRECT GOVERNOR SETTING.** Disconnect governor linkage at the carburetor, and check for sprung linkage or stuck throttle. If throttle and linkage operate freely, start and accelerate the engine. If a speed of 2,400 revolutions per minute is reached, the governor is faulty. Refer to higher authority for repair.

TROUBLE SHOOTING

d. Engine Misfires.

- (1) **FAULTY IGNITION SYSTEM** (sec. XIX).
- (2) **LOW ENGINE COMPRESSION** (subpar. e (7), above).
- (3) **INCORRECT CARBURETOR ADJUSTMENT.** Adjust carburetor (par. 62).
- (4) **CLOGGED FUEL TANK CAP VENT.** Open vents or replace cap.
- (5) **RESTRICTED FUEL FLOW** (par. 27).
- (6) **WATER IN FUEL.** Remove drain plug from bottom of carburetor and inspect for water. If found, drain all fuel from system, and refill with pure gasoline.

e. Excessive Oil Consumption.

- (1) **OIL VISCOSITY TOO LOW.** Drain crankcase, and refill with proper oil (par. 17).
- (2) **EXTERNAL OIL LEAKS.** Inspect for oil leaks at oil connections and gaskets, and tighten loose connections. If leakage is detected at oil pan gasket or at main bearing flanges, notify higher authority.
- (3) **PISTON AND RINGS WORN OR DAMAGED.** Notify higher authority.

f. Engine Will Not Stop.

- (1) **DEFECTIVE IGNITION SWITCH.** Replace switch (par. 84).
- (2) **ENGINE OVERHEATED.** Check oil temperature gage for evidence of high oil temperature. Determine if all cooling surfaces are free from dirt and oil. See that radiator doors are open. Test for clogging in oil filters.

26. CLUTCH.

a. Clutch Slips.

- (1) **CLUTCH OUT OF ADJUSTMENT.** Adjust clutch (par. 59).
- (2) **CLUTCH PEDAL OR LINKAGE BENT OR BINDING.** Disconnect linkage and inspect for bent or binding part. Replace defective parts (par. 60).
- (3) **CLUTCH WORN OR BROKEN INTERNALLY.** If linkage is in satisfactory condition and slippage cannot be removed through adjustment, internal wear or breakage is indicated. Notify higher authority.

b. Clutch Grabs.

- (1) **LOOSE MOUNTING.** Tighten external mounting nuts.
- (2) **INTERNAL DIFFICULTY.** If tightening external mounting nuts fails to remove trouble, internal difficulty is indicated. Notify higher authority.

4. TO 5-TON 4 x 4 TRACTOR TRUCK (AUTOCAR MODEL U-7144T)

c. Clutch Rattles.

(1) **LOOSE OR WORN CONTROL LINKAGE.** Inspect clutch linkage. Replace worn parts and tighten all loose parts.

(2) **INTERNAL DIFFICULTY.** If rattle persists with linkage in satisfactory condition, notify higher authority.

d. Clutch Will Not Release.

(1) **CLUTCH LINKAGE OUT OF ADJUSTMENT.** Adjust clutch linkage (par. 59). Replace defective parts of linkage.

(2) **CLUTCH OUT OF ADJUSTMENT.** Adjust clutch (par. 59).

(3) **INTERNAL DIFFICULTY.** If clutch cannot be adjusted to release, and linkage is in satisfactory condition and adjustment, notify higher authority.

e. Clutch Makes a Scrubbing Noise.

(1) **CLUTCH SLEEVE SCORED OR RIDGED.** Notify higher authority.

27. FUEL SYSTEM.

a. Fuel Does not Reach Carburetor.

(1) **LACK OF FUEL.** Check gage on instrument panel, and replenish fuel.

(2) **CLOGGED FUEL TANK VENT.** Remove obstruction from vent or replace cap.

(3) **INOPERATIVE FUEL PUMP; CLOGGED FUEL FILTER OR LINES.** Remove drain plug from fuel filter, and check passage from tank by blowing through line. If obstruction is indicated, remove and clean fuel line. Service fuel filter, and if passage to fuel pump is unobstructed, reconnect fuel line. Disconnect fuel line to carburetor from fuel pump. Turn engine over by means of cranking motor. If fuel does not flow from pump, a defective pump is indicated. Otherwise, the fuel line from pump to carburetor is obstructed. Repair or replace defective parts (pars. 63 and 66).

b. Fuel Does Not Reach Cylinders.

(1) **CARBURETOR STRAINER CLOGGED.** Clean or replace strainer (par. 62).

(2) **THROTTLE NOT OPENING.** Adjust throttle (par. 62).

(3) **CARBURETOR JETS CLOGGED.** Replace carburetor (par. 62).

28. INTAKE AND EXHAUST SYSTEM.

a. Air Passage to Carburetor Restricted.

(1) **AIR CLEANER DIRTY.** Service air cleaner (par. 68).

(2) **AIR PIPE CRUSHED.** Visually inspect air pipe. Replace if damaged (par. 68).

TROUBLE SHOOTING

b. Dirt Laden Air Entering Carburetor.

- (1) **AIR CLEANER DIRTY.** Service air cleaner (par. 68).
- (2) **NO OIL IN AIR CLEANER.** Service air cleaner (par. 68).
- (3) **AIR PIPE DISCONNECTED OR LOOSELY CONNECTED.** Connect air pipe tightly.

c. Exhaust Makes Excessive Noise and/or System Emits Unpleasant Gas.

(1) **MANIFOLD GASKETS LEAKING.** Inspect gaskets with engine running. If gaskets are leaking, tighten manifold attaching nuts. If leak persists, notify higher authority.

(2) **LEAK AT EXHAUST PIPE FLANGE.** Visually inspect connection with engine running. If gasket leaks, tighten nuts. If leak persists, replace gasket (par. 69).

(3) **EXHAUST PIPE BROKEN OR BENT AND PULLED FROM MUFFLER.** Inspect pipe with engine running, and replace pipe if broken or bent (par. 69).

(4) **TAIL PIPE PULLED FROM MUFFLER, LOST OR BROKEN.** Inspect tail pipe. Connect if disconnected; replace if lost or broken (par. 71).

(5) **MUFFLER DEFECTIVE.** If other parts of system are in satisfactory condition and excessive noise persists, replace muffler (par. 70).

29. COOLING SYSTEM.

a. Engine Overheats.

- (1) **INSUFFICIENT COOLANT.** Fill cooling system (par. 73).
- (2) **FAN BELT LOOSE OR BROKEN.** Inspect fan belt. Replace belt if broken, and adjust tension if loose (par. 78).
- (3) **THERMOSTAT STICKING SHUT.** Remove (par. 76) and test thermostat by dropping it in water heated to 180°F. If it fails to open, replace it.
- (4) **COOLING SYSTEM CLOGGED.** Fill system to capacity, then start and accelerate engine. If water flows from the radiator overflow indicating a clogged radiator, flush system.
- (5) **WATER PUMP INOPERATIVE.** Disconnect upper hose connection (par. 75). Fill both engine and radiator as full as possible, with the hose disconnected. Start engine. If water fails to flow from upper hose connection, replace water pump (par. 74).
- (6) **OVERHEATING DUE TO OTHER CONDITIONS.** If the case for overheating cannot be located within the cooling system, check for ignition, dragging brakes, insufficient lubrication, and incorrect valve timing.

4. TO 5-TON 4 x 4 TRACTOR TRUCK (AUTOCAR MODEL U-7144T)

b. Engine Slow To Warm Up.

(1) **THERMOSTAT DEFECTIVE.** Remove and test thermostat (par. 76), and replace if it remains open at room temperature.

(2) **TEMPERATURE GAGE DEFECTIVE.** Replace inaccurate gage.

c. System Leaks Coolant.

(1) **DEFECTIVE HOSE CONNECTION.** Tighten leaking connections, and if leak persists, replace hose (par. 75).

(2) **WATER PUMP PACKING WORN.** Check pump for leakage, and if found, refer to higher authority.

(3) **RADIATOR CORE LEAKING.** Visually inspect core, and replace if leak is detected (par. 73). Refer core to higher authority for repair.

30. IGNITION SYSTEM.

a. Improper Ignition.

(1) **SPARK PLUGS FAULTY.** Uneven operation at idle speed, misfiring at high speed, or loss of power may be due to faulty spark plugs. Remove and inspect spark plugs (par. 83). Replace all faulty plugs.

(2) **DISTRIBUTOR POINTS FAULTY.** Hard starting or complete failure to start on the part of the engine may be due to faulty distributor points. Remove distributor cap and inspect points. Measure gap. Crank engine, and observe opening and closing of points. Adjust points if out of adjustment (par. 82). Replace points if pitted, burned, or broken (par. 82). Replace distributor if mechanical action of opening and closing mechanism is faulty. Refer old distributor to higher authority for repair or rebuilding.

(3) **IGNITION COIL OR CONDENSER FAULTY.** Weak or no spark, with fully charged battery, and serviceable spark plugs and distributor points installed, may indicate a faulty ignition coil or condenser. Remove suspected coil and/or condenser, and replace it with a part known to function properly (pars. 80 and 81).

(4) **FAULTY RADIO NOISE SUPPRESSION EQUIPMENT.** Test dual unit filter (par. 45). Replace filter if faulty (par. 45).

31. STARTING AND GENERATING SYSTEM.

a. Low Generator Output.

(1) **BATTERY FULLY CHARGED.** No repair is necessary.

(2) **DIRT ON COMMUTATOR.** Remove inspection cover from generator. If dirt can be seen on commutator bars, start engine and hold a piece of flat paper 2/0 against bars. Blow dust from generator with dry compressed air (par. 87).

(3) **BRUSHES WORN.** Inspect brushes and replace if worn (par. 87).

TROUBLE SHOOTING

(4) **GENERATOR REGULATOR OUT OF ADJUSTMENT.** If trouble is not due to one of above causes, replace regulator.

(5) **CAUSES EXTERNAL TO GENERATOR.** Low generator output can be caused by high resistance in either battery or in wiring between the generator and batteries, or in radio noise suppression equipment. Check all wiring connections to be sure they are clean and tight. Test individual wires with a test light. Test dual unit filter, and generator condenser. Clean and tighten all connections. If trouble persists, replace the batteries (par. 154).

b. Unsteady or Insufficient Generator Output.

(1) **DIRT ON COMMUTATOR** (subpar. a (2), above).

(2) **BRUSHES WORN** (subpar. a (3), above).

(3) **SHORTED, OPEN, OR GROUNDED WIRING; LOOSE, OPEN, OR DIRTY CONNECTION.** Inspect all wiring. Use test light to test individual wires. Clean and tighten all connections. Replace or repair broken or poorly insulated wires.

(4) **GENERATOR REGULATOR INOPERATIVE.** Inspect regulator (par. 88).

c. High Generator Output.

(1) **LOW BATTERY.** Test battery with a hydrometer. If specific gravity is below 1.275, high generator output is normal, and no repair necessary.

(2) **HIGH RESISTANCE WIRING.** Inspect wiring, using test light on individual wires. Clean and tighten all connections, and replace defective wires.

(3) **OVERHEATED BATTERY.** Feel battery case with hand, and if it is hot, allow it to cool. Add water before using again (par. 154).

(4) **VOLTAGE REGULATOR INOPERATIVE.** Test operation of voltage regulator (par. 88).

(5) **SHORTED OR GROUNDED GENERATOR FIELD CIRCUIT.** If none of the above causes are at fault, a shorted or grounded field circuit is indicated. Replace generator, and refer old generator to higher authority.

d. Noisy Generator.

(1) **MOUNTING BOLTS LOOSE.** Tighten mounting bolts.

(2) **LACK OF LUBRICATION.** Lubricate generator (par. 17).

(3) **WORN COMMUTATOR OR BEARINGS.** If noise persists after tightening and lubricating, replace generator.

e. Cranking Motor Inoperative.

(1) **DISCHARGED BATTERY.** Check battery (par. 154).

(2) **BROKEN BATTERY CABLE OR TERMINAL.** Inspect cables from

4- TO 5-TON 4 x 4 TRACTOR TRUCK (AUTOCAR MODEL U-7144T)

batteries to ground, and from batteries to cranking motor. Replace all broken cables.

(3) **INOPERATIVE SWITCH.** Short circuit terminals of switch with a heavy metal tool pressed firmly across terminals. If cranking motor operates, an inoperative switch is indicated. Replace switch.

(4) **INTERNAL DEFECT IN CRANKING MOTOR.** Disconnect cable from cranking motor, and press on cranking motor switch. Touch end of cable to frame of vehicle for an instant. Sparks indicate inoperative cranking motor has internal defect. Replace cranking motor.

32. BATTERY AND LIGHTING SYSTEM.

a. **Battery Cells All Test Over 1.250 Specific Gravity and Within 15 Points of Each Other.**

(1) **BATTERY NORMAL.** No corrective measures necessary in summer. For cold weather operation, give batteries booster charge if cells are under 1.275.

b. **Battery Cells All Test Under 1.250 Specific Gravity and Within 15 Points of Each Other.**

(1) **DEMAND FROM BATTERIES EXCEEDS INPUT FROM GENERATOR.** Recharge batteries. Check electrical system for short circuits, loose connections, and low generator output. Increase charging rate (par. 154).

c. **Cells of Battery Vary by 15 or More Points From Each Other With Highest Cell Reading 1.225 Specific Gravity or Over.**

(1) **SHORT CIRCUITS.** Make a momentary high rate test on each cell. If cells vary by more than $\frac{1}{16}$ volt from each other, replace battery; otherwise, recharge until gravity of electrolyte remains constant for 4 hours. Adjust gravity of all cells by adding water or small amounts of sulphuric acid (1.400 specific gravity or less).

(2) **EVAPORATION CAUSED BY OVERCHARGING.** Treat battery as in step (1) above. Reduce charging rate of generator (par. 154).

(3) **UNNECESSARY ADDITION OF ACID.** Treat battery as in step (1) above.

(4) **LOSS OF ELECTROLYTE BY LEAKAGE.** Replace battery if case is broken, and refer used battery to higher authority. If electrolyte was lost by tipping battery or by missing caps, treat battery as outlined in step (1) above.

d. **Cells of Battery Vary by 15 or More Points From Each Other With Highest Cell Reading Under 1.225 Specific Gravity.**

(1) **SHORT CIRCUITS.** Recharge battery if possible; then make a momentary high rate discharge test. If battery fails to recharge, or if cells vary by $\frac{1}{16}$ or more volts after recharge, replace battery. Other-

TROUBLE SHOOTING

wise, adjust gravity of all cells by adding water or small amounts of sulphuric acid (1.400 specific gravity or less).

(2) **EVAPORATION CAUSED BY OVERCHARGING.** Reduce charging rate of generator and treat battery as outlined in step (1), above.

(3) **UNNECESSARY ADDITION OF ACID.** Treat battery as given in step (1), above.

(4) **LOSS OF ELECTROLYTE BY LEAKAGE.** Replace battery if case is broken. If electrolyte was lost by tipping battery, treat as outlined in step (1), above.

e. Cells of Battery Test Over 1.300 Specific Gravity at 80°F.

(1) **UNNECESSARY ADDITION OF ACID.** Drain all solution from battery. Refill with diluted (1.100 specific gravity) electrolyte, and charge at low rate until electrolyte remains constant for 4 hours. Drain cells again, and refill with 1.285 specific gravity electrolyte. Charge for 3 hours, adjust gravity to 1.285, and continue charging until gravity of all cells is constant for 2 hours. If this proves impossible, replace battery (par. 154).

(2) **ADDITION OF BATTERY COMPOUND OR "DOPE" SOLUTIONS.** Try treating battery as outlined in step (1), above, then replace if necessary.

f. Battery Fully Charged but Tests 1.265 Specific Gravity or Less at 80°F.

(1) **EXCESSIVE EVAPORATION USUALLY CAUSED BY OVERCHARGING.** Reduce charging rate of generator (par. 87). Add small amounts of acid (1.400 specific gravity or less) to cells to adjust electrolyte to 1.285 specific gravity.

g. Frequent Additions of Water Necessary.

(1) **EXCESSIVE GENERATOR CHARGING RATE.** Adjust charging rate (par. 87).

(2) **BROKEN BATTERY CASE.** Replace battery, and refer used battery to higher authority.

h. Bulge in Battery Case.

(1) **EXCESSIVE TEMPERATURE DUE TO OVERCHARGING.** Treat battery as outlined in subparagraph d (1), above. Adjust generator output (par. 87).

i. Corrosion on Battery Terminals.

(1) **EXCESSIVE CHARGING RATE CAUSING ACID TO SPRAY ON TERMINALS.** Remove terminals from posts. Clean posts and terminals thoroughly. Replace cable if terminal is weakened by corrosion. Connect terminals, and apply a film of No. 2 general purpose grease or vaseline to exposed metal. Adjust generator output (par. 87).

4- TO 5-TON 4 x 4 TRACTOR TRUCK (AUTOCAR MODEL U-7144T)

(2) **LEAD COATING ON TERMINALS DESTROYED.** Proceed as directed in step (1), above.

j. Broken Terminal Post on Battery.

(1) **LOOSE BATTERY INSTALLATION.** Replace battery (par. 154).

(2) **BATTERY CABLE TOO SHORT.** Replace battery and cable (par. 154).

k. All Lights Fail To Operate.

(1) **CIRCUIT BREAKER OPEN.** Close circuit breaker. If it snaps open again, look for short circuit.

(2) **BATTERIES DEAD.** Check for cause including short circuits, and eliminate. Recharge or replace batteries.

(3) **OPEN CIRCUIT IN CABLES OR WIRES.** Inspect wiring, and if open circuit cannot be seen, locate with test light. Connect disconnected wires or cables, and replace broken wires or cables.

l. One Light Fails To Operate.

(1) **BURNED OUT LAMP.** Replace lamp.

(2) **LAMP LOOSE IN SOCKET.** Install lamp properly.

(3) **OPEN CIRCUIT IN CIRCUIT TO LIGHT.** Proceed as directed in subparagraph k (3), above.

(4) **LIGHT NOT GROUNDED.** Remove light and clean points of contact on light and vehicle until shiny. Install light.

33. TRANSMISSION.

a. Transmission Noisy.

(1) **INCORRECT OR INSUFFICIENT LUBRICANT.** Check lubricant, and lubricate if necessary.

(2) **TRANSMISSION CASE LOOSE ON CLUTCH HOUSING.** Tighten housing.

(3) **CLUTCH HOUSING LOOSE ON ENGINE.** Tighten housing.

(4) **INTERNAL DEFECT.** If noise persists after above measures have been taken, report trouble to higher authority.

b. Gears Slip Out of Mesh.

(1) **INTERNAL DEFECT.** Report condition to higher authority.

c. Lubricant Leaks From Case.

(1) **LOOSE CASE BOLTS.** Tighten case.

(2) **INTERNAL DEFECT.** Report condition to higher authority.

34. TRANSFER CASE.

a. Transfer Case Noisy.

(1) **LOOSE MOUNTING.** Tighten mounting.

(2) **INCORRECT OR INSUFFICIENT LUBRICANT.** Check lubricant, and lubricate if necessary.

TROUBLE SHOOTING

(3) **CONNECTING PROPELLER SHAFT LOOSE.** Tighten propeller shaft.

(4) **INTERNAL DEFECT.** If noise persists after the above checks, report the condition to higher authority.

b. Transfer Case Slips Out of Gear.

(1) **LINKAGE BROKEN OR OUT OF ADJUSTMENT.** Inspect linkage, and adjust or replace broken parts (par. 97).

(2) **INTERNAL DEFECT.** Report leak to higher authority.

35. PROPELLER SHAFTS AND UNIVERSAL JOINTS.

a. Propeller Shaft Rattles When Vehicle Is Coasting.

(1) **WORN SPLINES OR BEARING CUPS.** Replace propeller shaft and attached universal joints (pars. 101, 102, and 103). Refer old shaft to higher authority.

b. Propeller Shaft Vibrates.

(1) **LOOSE BOLTS AT UNIVERSAL JOINT COMPANION FLANGES.** Tighten loose bolts.

(2) **PROPELLER SHAFT OUT OF BALANCE OR MISALIGNED.** Replace propeller shaft and attached universal joints (pars. 101, 102, and 103). Refer old assembly to higher authority.

c. Backlash in Propeller Shaft.

(1) **WORN BEARING IN UNIVERSAL JOINT.** Replace assembly (pars. 101, 102, and 103). Refer old part to higher authority.

(2) **LOOSE BOLTS AT UNIVERSAL JOINT COMPANION FLANGES.** Tighten loose bolts.

36. FRONT AXLE.

a. Continuous Humming Noise.

(1) **LACK OF LUBRICATION.** Lubricate properly (par. 17).

(2) **WHEEL BEARINGS TOO TIGHT.** Adjust wheel bearing (par. 134).

(3) **BEVEL OR SPUR PINION BEARINGS TOO TIGHT.** Notify higher authority.

b. Humming Noise Noticeable Only When Coasting.

(1) **WHEEL BEARINGS WORN.** Replace wheel bearings (par. 134).

(2) **INTERNAL PARTS WORN OR OUT OF ADJUSTMENT.** Notify higher authority.

c. Humming Noise Noticeable Only When Pulling.

(1) **INCORRECT BACKLASH ADJUSTMENT BETWEEN BEVEL GEAR AND PINION.** Notify higher authority.

4. TO 5-TON 4 x 4 TRACTOR TRUCK (AUTOCAR MODEL U-71447)**d. Backlash Noticeable in Front Wheels When Stopping and/or Starting.**

- (1) **PROPELLER SHAFT LOOSE.** Tighten propeller shaft (par. 101).
- (2) **INTERNAL PART WORN OR MALADJUSTED.** Notify higher authority.
- (3) **LOOSE HOUSING BOLTS.** Tighten loose housing bolts.
- (4) **DEFECTIVE GASKET, OIL SEAL, OR GREASE RETAINER.** Notify higher authority.

37. REAR AXLE.**a. Continuous Humming Noise.**

- (1) **LACK OF, OR IMPROPER LUBRICATION.** Lubricate properly (par. 17).
- (2) **BEARINGS TOO TIGHT.** Notify higher authority.

b. Humming Noise Noticeable Only When Coasting.

- (1) **WORN BEARINGS OR INCORRECT BEVEL GEAR AND PINION ADJUSTMENT.** Notify higher authority.

c. Humming Noise Noticeable Only When Pulling.

- (1) **INCORRECT BEVEL GEAR AND PINION ADJUSTMENT.** Notify higher authority.

d. Backlash Noticeable When Stopping and/or Starting.

- (1) **LOOSE PROPELLER SHAFT.** Tighten propeller shaft (par. 102).
- (2) **CLUTCH OUT OF ADJUSTMENT OR WORN.** Adjust clutch. If trouble persists, notify higher authority.
- (3) **INTERNAL MALADJUSTMENT OR WEAR.** Notify higher authority.

e. Lubricant Leaks From Housing.

- (1) **LOOSE HOUSING BOLTS.** Tighten loose bolts.
- (2) **WORN OR DAMAGED GASKET, OIL SEAL, OR GREASE RETAINER.** Notify higher authority.

38. SERVICE BRAKE SYSTEM.**a. Brake Pedal Goes to Floor Board.**

- (1) **NORMAL WEAR OF BRAKE LINING.** Adjust brakes. If brakes are worn so that adjustment fails to eliminate trouble, notify higher authority.
- (2) **LOW AIR PRESSURE.** Observe pressure as indicated on gage. If the pressure is less than 105 pounds start engine and build up pressure. Should pressure fail to build up, check system for leaks or inoperative units.

TROUBLE SHOOTING

(3) **WATER TRAPPED IN AIR SYSTEM.** Drain reservoir tank (par. 114).

b. Brakes Drag.

(1) **BRAKE CONTROL ROD ADJUSTED TOO SHORT.** Remove clevis pin, and loosen lock nut. Turn yokes counterclockwise to lengthen rod. Tighten lock nut, and connect rod.

(2) **BRAKE CONTROL ROD RETURN SPRING WEAKENED OR BROKEN.** Remove spring from control rod and brake application valve bracket. Replace with serviceable spring.

(3) **WATER TRAPPED IN SYSTEM.** Drain reservoir tank (par. 114).

c. One Brake Drags.

(1) **GREASE ON BRAKE LINING.** Replace brake shoes (par. 127). Return old shoes to third echelon for relining. Check condition of grease retainers, and replace if defective.

(2) **BRAKE SHOES OUT OF ADJUSTMENT.** Adjust brakes (par. 127).

(3) **LINING LOOSENED FROM SHOE.** Replace brake shoe (par. 127).

(4) **BRAKE SHOE SPRING WEAKENED OR BROKEN.** Replace brake shoe spring (par. 127).

(5) **CLOGGED AIR TUBE ON HOSE.** Clean or replace unobstructed part.

(6) **BRAKE ANCHOR PIN TIGHT.** Replace brake anchor pin (par. 127).

(7) **WHEEL BEARINGS OUT OF ADJUSTMENT.** Adjust wheel bearings (par. 134).

d. Truck Pulls to Right or Left When Brakes Are Applied and/or Brakes Are Uneven.

(1) **BRAKE ON FRONT WHEEL DRAGGING** (subpar. c, above).

(2) **BRAKES NEED ADJUSTING OR LUBRICATING.** Adjust (par. 126) and/or lubricate brakes.

(3) **BRAKES NEED RELINING.** Report to higher authority.

(4) **GREASE ON BRAKE LINING** (subpar. c (1), above).

(5) **BRAKE SHOE RELEASE SPRING OR BRAKE DIAPHRAGM CHAMBER RELEASE SPRING BROKEN.** Replace broken spring.

(6) **BRAKE DRUM OUT OF ROUND.** Replace drum, and return used parts to higher authority.

(7) **LEAKING BRAKE CHAMBER DIAPHRAGM.** Replace diaphragm (par. 122).

4. TO 5-TON 4x4 TRACTOR TRUCK (AUTOCAR MODEL U-7144T)

e. Brakes Take Hold Slowly.

- (1) **BRAKES OUT OF ADJUSTMENT.** Adjust brakes (par. 126).
- (2) **BRAKE LINING WORN.** Replace brake shoes (par. 127).
- (3) **BRAKE DRUMS WORN.** Replace hubs. Return used parts to higher authority.
- (4) **OBSTRUCTED AIR LINE.** Remove obstruction from air line or hose, or replace part.
- (5) **BRAKE MECHANISM NEEDS LUBRICATION.** Lubricate vehicle (par. 17).
- (6) **LOW AIR PRESSURE IN BRAKE SYSTEM** (subpar. k, below).
- (7) **BRAKE VALVE DELIVERY LOW.** Check brake valve delivery pressure. Adjust brake valve linkage, or replace brake valve (par. 116).
- (8) **EXCESSIVE LEAKAGE WITH BRAKES APPLIED.** Check for leakage, and service or replace defective units.
- (9) **OBSTRUCTED TUBING LINES.** Disconnect both ends of suspected line. Blow out obstruction, if possible; otherwise replace line.
- (10) **OBSTRUCTED HOSE LINE.** Disconnect both ends of suspected line. Blow out obstruction if possible; otherwise replace line.

f. Brakes Release Slowly.

- (1) **BRAKE CONTROL ROD NOT RETURNING PROPERLY.** Check adjustment of control rod, and adjust if necessary (par. 115). Check condition of brake control rod return spring, and replace spring if broken or weakened.
- (2) **OBSTRUCTED TUBE OR HOSE.** Remove obstruction, or replace faulty tube or hose (par. 124).
- (3) **DEFECTIVE AIR RELEASE VALVE.** Replace defective valve (par. 119).
- (4) **BRAKE CAMSHAFT BINDING.** Lubricate brake cam with engine oil. **CAUTION: Do not get oil on lining.**
- (5) **BRAKES NEED ADJUSTING OR LUBRICATING.** Adjust (par. 126) and/or lubricate brakes.
- (6) **EXHAUST PORT OF BRAKE VALVE, QUICK RELEASE VALVE, OR RELAY VALVE OBSTRUCTED.** Remove obstruction.
- (7) **DEFECTIVE BRAKE VALVE, QUICK RELEASE VALVE, OR RELAY VALVE.** Replace defective valve (pars. 115, 119, and 118, respectively).

g. Insufficient Brakes.

- (1) **BRAKES NEED ADJUSTING, LUBRICATING, OR RELINING.** Adjust (par. 126), lubricate (par. 17) brakes, or report to higher authority.

TROUBLE SHOOTING

- (2) **LOW AIR PRESSURE** (subpar. h. below).
- (3) **BRAKE VALVE DELIVERY PRESSURE LOW.** Check brake valve delivery pressure. Adjust valve linkage, or replace valve (par. 116).

h. Brakes Do Not Apply.

- (1) **NO AIR PRESSURE.** Start engine and build up air pressure.
- (2) **RESTRICTED OR BROKEN TUBING OR HOSE.** Disconnect both ends of restricted line, and apply air pressure. Check for break. Replace line if impossible to blow out obstruction or if line is broken.
- (3) **DEFECTIVE BRAKE VALVE.** Replace valve (par. 116).

i. Brakes Do Not Release.

- (1) **BRAKE RIGGING BINDING.** Straighten or replace bent parts; replace worn or broken parts. Lubricate rigging.
- (2) **BRAKE VALVE NOT RETURNING TO FULL RELEASED POSITION.** Adjust retracting spring tension, and check control rod and pedal to see if either is binding. Free and lubricate binding parts.
- (3) **BRAKE VALVE IN APPLIED POSITION.** Move valve to released position.
- (4) **BRAKE VALVE DEFECTIVE.** Replace valve (par. 116).
- (5) **OBSTRUCTED TUBING OR HOSE.** Disconnect both ends of suspected line, and blow out with compressed air. Replace line if impossible to remove obstruction.
- (6) **AIR TRAPPED IN FRONT SERVICE LINE BEYOND DOUBLE CHECK VALVE.** This is caused by obstruction in or absence of vent hole in dummy coupling. Clear vent hole in dummy coupling, or replace with coupling having vent hole.

j. Brakes Grab.

- (1) **GREASE ON LINING.** Report to higher authority.
- (2) **BRAKE DRUM OUT OF ROUND.** Replace drum (par. 134).
- (3) **DEFECTIVE BRAKE VALVE.** Replace valve (par. 116).
- (4) **BRAKE RIGGING BINDING.** Straighten or replace bent parts; replace broken and worn parts. Lubricate rigging.

k. Air Pressure Will Not Rise to Normal (80 to 105 Pounds).

- (1) **INACCURATE AIR GAGE.** Replace gage (par. 175).
- (2) **EXCESSIVE LEAKAGE.** Start engine and build up as much pressure as possible. Check all connections and units for leaks with brakes applied and not applied, using soapy water to detect leaks which cannot be felt or heard. Tighten loose connections, and replace defective parts.
- (3) **RESERVOIR TANK DRAIN COCK OPEN.** Close drain cock on bottom of each tank.

4. TO 5-TON 4 x 4 TRACTOR TRUCK (AUTOCAR MODEL U-7144T)

(4) **GOVERNOR OUT OF ADJUSTMENT.** Adjust governor (par. 113).

(5) **NO CLEARANCE AT COMPRESSOR UNLOADING VALVES.** Adjust clearance to 0.010 inch minimum, 0.015-inch maximum (par. 112).

(6) **FAN BELTS SLIPPING ON COMPRESSOR PULLEY.** Adjust fan belt tension (par. 78).

(7) **DEFECTIVE COMPRESSOR.** Replace compressor (par. 112).

l. Air Pressure Rises Too Slowly to Normal (80 to 105 Pounds).

(1) **EXCESSIVE LEAKAGE.** Check for leakage, and service or replace defective units.

(2) **CLOGGED COMPRESSOR AIR STRAINER.** Service air strainer (par. 112).

(3) **NO CLEARANCE AT COMPRESSOR UNLOADING VALVES.** Adjust clearance to 0.010-inch minimum, 0.015-inch maximum (par. 112).

(4) **ENGINE SPEED TOO LOW.** Increase engine speed.

(5) **COMPRESSOR DISCHARGE VALVES LEAKING.** Replace compressor cylinder head or compressor (par. 112).

(6) **EXCESSIVE CARBON IN COMPRESSOR CYLINDER HEAD OR DISCHARGE LINE.** Replace compressor cylinder head, compressor, or discharge line (par. 112).

m. Air Pressure Rises Above Normal (80 to 105 Pounds).

(1) **DEFECTIVE AIR GAGE REGISTERING INCORRECTLY.** Replace gage (par. 175).

(2) **DEFECTIVE GOVERNOR.** Replace governor (par. 113).

(3) **GOVERNOR OUT OF ADJUSTMENT.** Adjust governor (par. 113).

(4) **RESTRICTION IN GOVERNOR TO COMPRESSOR TUBE.** Disconnect both ends of tube, and apply compressed air. If impossible to remove obstruction, replace tube.

(5) **TOO MUCH CLEARANCE AT COMPRESSOR UNLOADING VALVES.** Adjust clearance to 0.010-inch minimum, 0.015-inch maximum.

(6) **UNLOADING VALVE CAVITIES OR PASSAGE BLOCKED WITH CARBON.** Replace compressor cylinder head or compressor (par. 112).

(7) **UNLOADING VALVES STUCK CLOSED.** Replace compressor cylinder head or compressor (par. 112).

n. Air Pressure Drops Quickly With Engine Stopped and Brakes Released.

(1) **LEAKING BRAKE VALVE.** Replace valve (par. 116).

TROUBLE SHOOTING

- (2) **LEAKING RELAY VALVE.** Replace valve (par. 118).
- (3) **LEAKING TUBING OR HOSE.** Service or replace line (par. 124).
- (4) **COMPRESSOR DISCHARGE VALVES LEAKING.** Replace compressor cylinder head or compressor (par. 112).
- (5) **GOVERNOR LEAKING.** Service or replace governor (par. 113).
- (6) **EXCESSIVE LEAKAGE ELSEWHERE IN SYSTEM** (subpar. k (2), above).

n. Air Pressure Drops Quickly With Engine Stopped and Brakes Fully Applied.

- (1) **LEAKING BRAKE CHAMBER DIAPHRAGMS.** Replace chambers or diaphragms (par. 122).
- (2) **LEAK IN BRAKE VALVE, RELAY VALVE, TUBING, OR HOSE.** Service or replace leaking part.
- (3) **DRAIN COCK OR CUT-OUT COCK LEFT OPEN.** Close cock.

p. Compressor Knocks.

- (1) **LOOSE DRIVE PULLEY.** Tighten pulley.
- (2) **BACKLASH IN DRIVE GEARS OR DRIVE COUPLING.** Report to higher authority, or replace compressor (par. 112).
- (3) **WORN BEARINGS.** Replace compressor (par. 112).
- (4) **EXCESSIVE CARBON IN COMPRESSOR CYLINDER HEAD.** Replace compressor cylinder head or compressor (par. 112).

q. Brake Valve "Groans" When Brakes Are Applied.

- (1) **DEFECTIVE BRAKE VALVE.** Replace valve (par. 116).

r. Relay Valve "Groans" or "Chatters" When Brakes Are Applied.

- (1) **DEFECTIVE RELAY VALVE.** Replace valve (par. 118).

s. Quick Release Valve "Blats" When Brakes Are Released.

- (1) **DEFECTIVE QUICK RELEASE VALVE.** Replace valve (par. 119).

t. Safety Valve "Blows Off."

- (1) **SAFETY VALVE OUT OF ADJUSTMENT.** Replace safety valve, and refer original valve to higher authority (par. 115).
- (2) **AIR PRESSURE ABOVE NORMAL** (subpar. m, above).

39. PROPELLER SHAFT BRAKE SYSTEM.

s. Brake Does Not Hold.

- (1) **BRAKE OUT OF ADJUSTMENT.** Adjust brake (par. 129).
- (2) **BRAKE LINING WORN.** Try adjusting brakes (par. 129); if trouble persists, replace shoes (par. 129).

4. TO 5-TON 4x4 TRACTOR TRUCK (AUTOCAR MODEL U-7144T)

(3) **BRAKE SHOE LINING GLAZED OR GREASED.** Replace brake shoes (par. 129).

(4) **BRAKE DISK WORN AND/OR GLAZED.** Report trouble to highest authority.

40. WHEELS, HUBS, WHEEL BEARINGS, AND TIRES.

a. Pounding or Squeaking Noise in Wheel.

(1) **WHEEL HUB STUD CAP NUTS LOOSE.** Tighten cap nuts (par. 133).

(2) **TIRE MOUNTED OUT OF BALANCE.** Disassemble tire, and assemble correctly (par. 135).

b. Wheel Drags and Wheel Bearing Heals.

(1) **WHEEL BEARING ADJUSTED TOO TIGHT.** Adjust wheel bearing (par. 134).

c. Tires Overheat.

(1) **TIRES UNDERINFLATED.** Inflate tires to correct pressure (par. 135).

d. Excessive or Uneven Tire Wear.

(1) **TIRES INFLATED INCORRECTLY.** Inflate tires to correct pressure (par. 135).

(2) **TOE-IN OUT OF ADJUSTMENT.** Adjust toe-in (par. 105).

(3) **TIRES MOUNTED OUT OF BALANCE.** Remove tires, and mount correctly (par. 135).

41. SPRINGS AND SHOCK ABSORBERS.

a. Vehicle Bottoms or Skews.

(1) **BROKEN FRONT OR REAR SPRING.** Replace spring (pars. 136 and 137).

(2) **INOPERATIVE SHOCK ABSORBER.** Replace shock absorber (par. 138).

b. Truck Exceptionally Hard Riding.

(1) **SPRINGS LACK LUBRICATION.** Lubricate vehicle.

(2) **SHACKLE PINS FROZEN IN SHACKLE.** Replace shackle pins.

c. Exaggerated Spring Action.

(1) **SHOCK ABSORBER INOPERATIVE.** Replace shock absorber (par. 138).

(2) **WORN SHACKLE PINS AND BUSHINGS.** Replace shackle pins, springs, and shackles (par. 136). Refer used shackles and springs to higher authority.

TROUBLE SHOOTING

(3) **BROKEN SPRING REBOUND CLIPS.** Replace spring (pars. 136 and 137), and refer old spring to higher authority.

d. Springs Noisy.

(1) **SHACKLE PINS AND BUSHINGS WORN.** Replace shackles, springs, and pins, and refer used springs and shackles to higher authority.

(2) **SPRING REBOUND CLIPS LOOSE OR BROKEN.** Tighten loose clips. If clips are broken, replace spring, and refer used spring to higher authority.

(3) **BROKEN SPRING OR SHACKLE.** Replace broken part (pars. 136 and 137).

42. STEERING GEAR.

a. Front Wheels Shimmy.

(1) **WHEEL AND TIRE OUT OF BALANCE.** Inspect tire. If incorrectly mounted (with valve and balancing mark on tire not aligned), dismount tire and assemble correctly. If this does not remedy the trouble, refer the wheel and tire to higher authority for balancing.

(2) **DRAG LINK LOOSE.** Shake drag link, and tighten and adjust, if loose.

(3) **STEERING GEAR OUT OF ADJUSTMENT.** Adjust steering gear (par. 140).

(4) **STEERING GEAR WORN.** Refer to higher authority.

(5) **FRONT WHEEL BENT.** Jack up front of truck, spin wheels, and look for wobble. Replace bent wheel (par. 133).

(6) **LOOSE FRONT WHEEL BEARINGS.** Jack up truck, and check bearings for play. Adjust loose bearing (par. 134).

(7) **FRONT TIRE, WHEEL AND/OR HUB OUT OF BALANCE.** Jack up front of truck, spin wheels repeatedly, and notice if they always stop and ruck at same point. If out of balance, check mounting of tire. Dismount tire, and mount correctly if valve and balancing mark on tire are not aligned. If trouble persists, refer entire assembly to higher authority for balancing.

(8) **IMPROPER CASTER OR CAMBER.** Notify higher authority.

(9) **BENT FRAME.** Notify higher authority.

b. Front Wheel Wanders.

(1) **DRAG LINK LOOSE.** Shake drag link, and tighten and adjust if loose (par. 140).

(2) **WORN STEERING GEAR.** Replace steering gear. Refer to higher authority.

(3) **FRAME OF VEHICLE BENT.** Notify higher authority.

4- TO 5-TON 4x4 TRACTOR TRUCK (AUTOCAR MODEL U-7144T)

c. Vehicle Steers Hard.

(1) **STEERING GEAR AND/OR FRONT AXLE LACK PROPER LUBRICATION.** Lubricate vehicle correctly (par. 17).

(2) **TIRES UNDERINFLATED.** Inflate tires correctly (par. 135).

(3) **FRONT SPRING CLIPS LOOSE OR BROKEN.** Inspect front spring clips, and tighten if loose. If clips are broken, replace spring (pars. 136 and 137), and refer used spring to higher authority.

(4) **WORN STEERING GEAR.** Steering gear must be replaced; refer to higher authority.

(5) **FRAME OF VEHICLE BENT.** Notify higher authority.

d. Road Shocks Felt at Steering Wheel.

(1) **DRAG LINK ADJUSTED TOO TIGHT.** Adjust drag link (par. 140).

(2) **WORN STEERING GEAR.** Steering gear must be replaced; refer to higher authority.

e. Truck Pulls to Right or Left.

(1) **TIRES INFLATED UNEVENLY.** Inflate tires properly (par. 135).

f. Vehicle Hard to Straighten Out After Turn to Right or Left.

(1) **IMPROPER TIRE INFLATION.** Inflate tires to correct pressure (par. 135).

43. BODY AND FRAME.

a. Windshield Wiper Inoperative.

(1) **LEAK IN TUBING FROM MANIFOLD TO WIPER.** Start engine and inspect tubing. Place a liquid on doubtful spots; if it is drawn into tubing, a leak is indicated. Replace punctured or defective tubing.

(2) **CONNECTED HOSE OR TUBING.** Visually inspect tubing and hose, and straighten out kinks. Replace hose or tubing if it cracks or breaks.

(3) **DIRT ON EXTERIOR OF WIPER CASE BLOCKING AIR INTAKE.** Blow dirt from outside wiper motor case with compressed air.

(4) **INTERNAL DIRT OR WEAR.** Replace wiper (par. 145), and refer used wiper to higher authority.

b. Vehicle Steers Hard, Shimmies, Wanders, or Wheels Do Not Track.

(1) **FRAME BENT.** Notify higher authority.

TROUBLE SHOOTING

44. INSTRUMENTS.

a. Ammeter Inoperative.

- (1) **WIRE DISCONNECTED OR BROKEN.** Connect disconnected wire, and splice or replace broken wire.
- (2) **INTERNAL DEFECT.** Replace ammeter (par. 169).

b. Fuel Gage Does Not Register.

- (1) **NO FUEL IN TANK.** Fill fuel tank.
- (2) **OPEN CIRCUIT IN WIRING.** Inspect wires for breaks or disconnections. Use test light if open circuit cannot be located visually. Connect disconnected wires, and replace broken wires.
- (3) **FUEL GAGE TANK UNIT INOPERATIVE.** Replace tank unit (par. 170).
- (4) **GAGE INOPERATIVE.** Replace gage (par. 170).

c. Tachometer Pointer Noisy and/or Fluctuates and Jumps.

- (1) **FLEXIBLE SHAFT KINKED.** Examine cable. Remove kinks, or replace cable if permanently distorted (par. 171).
- (2) **FLEXIBLE SHAFT WORN AND BINDING.** Replace cable (par. 171).
- (3) **TACHOMETER HEAD WORN.** Replace tachometer head (par. 171).

d. Tachometer Inoperative.

- (1) **FLEXIBLE SHAFT BROKEN.** Examine shaft, and replace if broken (par. 171).
- (2) **DRIVE UNIT INOPERATIVE.** Replace drive unit (par. 171).
- (3) **HEAD INOPERATIVE.** Replace tachometer head (par. 171).

e. Speedometer Fluctuates and Jumps and/or is Noisy.

- (1) **CABLE KINKED.** Eliminate kinks, or replace cable if permanently bent (par. 172).
- (2) **CABLE WORN AND BINDING.** Replace cable (par. 172).
- (3) **SPEEDOMETER WORN.** Replace speedometer (par. 172).

f. Speedometer Inoperative.

- (1) **CABLE DISCONNECTED.** Connect cable (par. 172).
- (2) **CABLE BROKEN.** Replace cable (par. 172).
- (3) **DRIVE UNIT INOPERATIVE.** Replace drive unit (par. 172).
- (4) **INSTRUMENT INOPERATIVE.** Replace speedometer (par. 172).

g. Oil Gage Does Not Register.

- (1) **OIL PUMP INOPERATIVE OR ENGINE WITHOUT OIL PRESSURE FOR OTHER REASON.** Stop engine, and inspect oil lines for signs of oil

4. TO 5-TON 4 x 4 TRACTOR TRUCK (AUTOCAR MODEL U-7144T)

leakage. Replace leaking lines. If lines are not in satisfactory condition, notify higher authority.

(2) **LINE TO GAGE PLUGGED.** Remove line, and remove obstruction or replace line.

(3) **GAGE DEFECTIVE.** Replace gage (par. 173).

h. Temperature Gage Inoperative.

(1) **TUBE BROKEN OR DISCONNECTED.** Trace tube from gage to left side of rear cylinder head. Replace if broken; connect if disconnected (par. 174).

(2) **GAGE DEFECTIVE.** Replace gage (par. 174).

i. Air Pressure Gage Does Not Register.

(1) **NO AIR PRESSURE.** Start engine, but do not operate truck. If pressure fails to build up or if system fails to hold pressure, check tubing, hosing, fittings, and units in system for pressure leaks. Tighten or replace leaking parts.

(2) **OBSTRUCTION IN LINE TO GAGE.** Disconnect line from gage, and run engine. If air fails to come from line, disconnect tubing from fitting on engine side of air compressor. Disassemble two pieces of tubing from connecting hose and remove obstruction, or replace plugged tubing or hose (par. 175).

(3) **DEFECTIVE GAGE.** If air is emitted from tubing (step (2) above), a defective gage is indicated. Replace gage (par. 175).

j. Viscosity Gage Does Not Register.

(1) **NO OIL IN CRANKCASE.** Check engine oil, and add if necessary.

(2) **VISCOSITY GAGE OIL LINE OBSTRUCTED.** Disconnect line at gage and at viscosity gage instrument, near rear of left side of oil pan. Attempt to blow through line. If plugged, remove obstruction or replace line.

(3) **VISCOSITY GAGE INSTRUMENT DEFECTIVE.** If line was unobstructed but empty in preceding step, a defective viscosity instrument is indicated. Remove instrument from rear of left side of oil pan, and replace with a serviceable unit (par. 176).

(4) **VISCOSITY GAGE DEFECTIVE.** If tubing and instrument are in satisfactory condition, as determined in the two preceding steps, a defective gage is indicated. Replace gage (par. 176).

45. RADIO NOISE SUPPRESSION.

a. Radio Interference Noted With Engine Running and Vehicle Stationary.

(1) **IGNITION CIRCUIT NOISY.** Accelerate engine and turn off ignition switch. If crackling noise stops the instant switch is shut off,

ENGINE DATA, MAINTENANCE, AND ADJUSTMENT IN VEHICLE

trouble is in ignition circuit. Test dual unit filter (par. 181 b). Replace if faulty. Replace suppressors with equipment known to function properly. Clean and adjust spark plugs. Adjust ignition points. Clean and tighten all connections.

(2) **REGULATOR NOISY.** An irregular clicking noise, that continues for a moment after switch is turned off, indicates a noisy regulator. Check dual unit filter (par. 181 b). Clean and tighten all connections in circuit. If trouble persists, replace regulator.

(3) **GENERATOR NOISY.** A whining noise, that varies with engine speed and continues a moment after ignition switch is turned off, is caused by generator. Test generator condenser and dual unit filter (par. 181 b). Replace faulty units. Clean and tighten all connections in generator circuit. If trouble persists, replace generator.

h. Radio Interference Noted With Vehicle in Motion But Not Noticeable With Vehicle Stationary With Engine Running.

(1) **BOND STRAPS OR BOLTS LOOSE OR MISSING.** Check all bond straps (par. 184 a (2)) and bonding bolts, cleaning and tightening all connections. Replace missing parts. Check all body and frame nuts for tightness.

Section XIII**ENGINE DATA, MAINTENANCE, AND
ADJUSTMENT IN VEHICLE****46. DESCRIPTION AND TABULATED DATA.**

a. Description (figs. 11 and 12).

(1) The engine is a Hercules RXC 6-cylinder internal combustion gasoline engine of the "L" head type. The crankcase is cast integral with the block. Full length water jackets provide maximum cooling efficiency. A seven-bearing counterbalanced crankshaft is fitted with brass-backed replaceable type bearings. It has forged steel rods and cam ground, aluminum alloy pistons. The exhaust valve seats are a heat-treated cast-iron alloy. Water is drawn from the radiator by a gear driven pump, then forced through a long water manifold into the engine. A water bypass tube, which leads from the water connection on the front cylinder head to the coupling connection at the water pump, provides adequate circulation of the cooling fluid when the thermostat is closed. The engine is supported in the chassis by a three-point rubber mounting. The rear support arms are cushioned on brackets riveted to the side frame members. The trunnion type front support bracket, bolted to the engine support crossmember, permits the engine to pivot slightly with the torsional twist of the frame when the vehicle is being operated over rough ground.

4- TO 3-TON 4x4 TRACTOR TRUCK (AUTOCAR MODEL U-7144T)

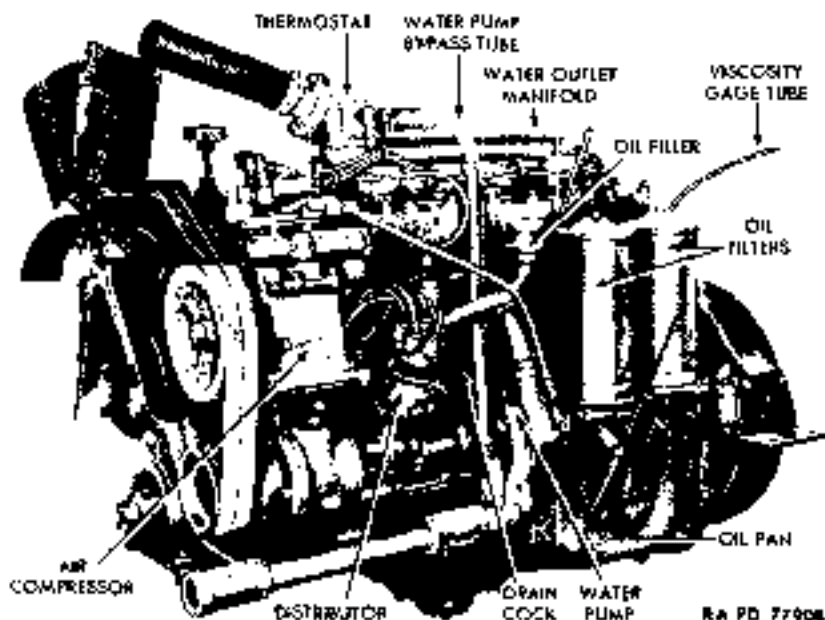

Figure 11 - Engine - Left Front

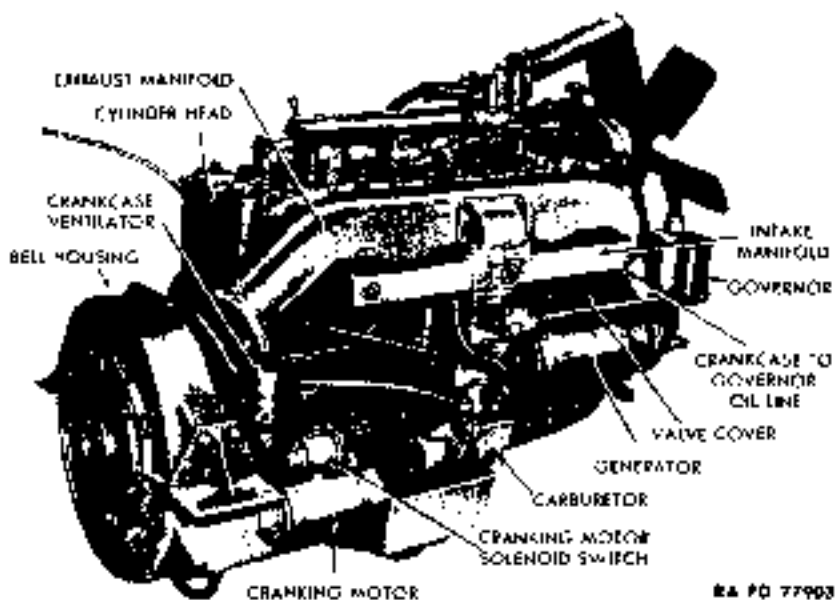

Figure 12 - Engine - Right Rear

ENGINE DATA, MAINTENANCE, AND ADJUSTMENT IN VEHICLE

k. Tabulated Data.

Bore	4 1/4 in.
Stroke	5 1/4 in.
Piston displacement	529 cu in.
Compression ratio	5.4 to 1
Maximum torque	395 lb-ft at 1,000 rpm
Net horsepower	112 at 2,300 rpm
Firing order	1-5-3-6-2-4
Compression pressure at cranking speed (all plugs removed)	90 to 95 lb
Cylinder head—material	Cast iron
Cylinder head—bolt tension	630 lb-in.

47. TUNE-UP.

a. General. Engine tune-up consists of a systematic series of adjustments to ensure efficient engine operation. Tune up engine after installation and every 1,000 miles or every month, whichever comes first. To avoid hit-and-miss tuning, make adjustments in the order given below:

(1) **ADJUST VALVE TAPPETS** (par. 51).

(2) **TEST ENGINE COMPRESSION.** Remove spark plugs (par. 83). Insert a compression gage into a spark plug hole. Crank engine and observe gage reading. Repeat test on each cylinder. If compression is below 85 pounds in any cylinder, or if it varies as much as 10 or 15 pounds between cylinders, notify higher authority.

(3) **CLEAN AND ADJUST SPARK PLUGS.** Clean each plug in a sand-blast spark plug cleaner. Measure gap between electrodes. Bend outside electrode to secure 0.025-inch gap. Test each plug in a spark plug testing machine. Replace plug if spark fails to flow freely across gap while under 105 pounds air pressure. Install spark plugs (par. 83).

(4) **CLEAN AND TIGHTEN CABLES.** Clean terminals, and tighten connections of battery cables and ignition wires.

(5) **ADJUST DISTRIBUTOR POINTS.** Check condition of distributor points, and adjust if necessary (par. 82).

(6) **ADJUST CARBURETOR** (par. 62).

48. CYLINDER HEAD AND GASKET REMOVAL.

a. Drain Cooling System. Open the two drain cocks, one of which is located on radiator outlet elbow, the other on the side of cylinder block above the water pump (fig. 11).

b. Remove Engine Hood (fig. 19). Disengage the two latches, and remove the three screws, lock washers, and flat washers which hold hood to floor board. Lift hood from vehicle.

4. TO 5-TON 4x4 TRACTOR TRUCK (AUTOCAR MODEL U-71447)

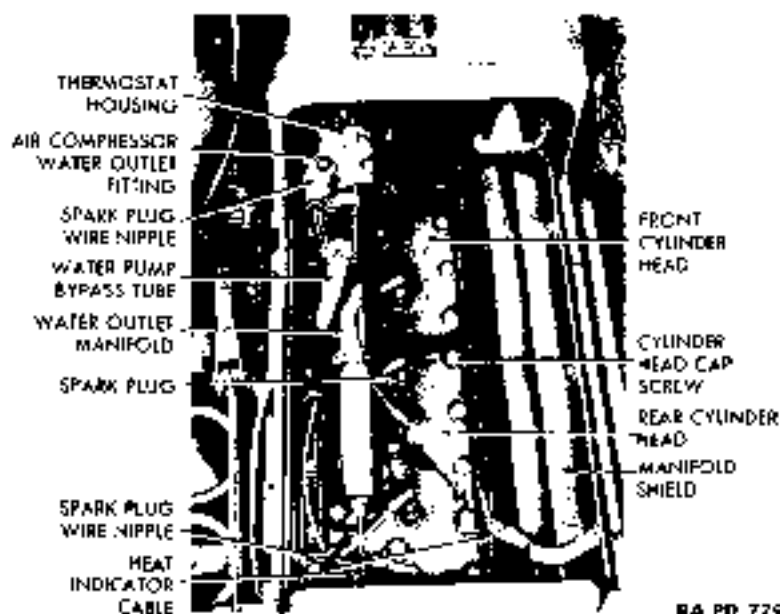

Figure 13 - Cylinder Heads Installed

RA PD 77966

c. **Remove Water Outlet Manifold** (fig. 13). Remove the two cap screws and lock washers which secure water outlet hose flange to manifold. Remove gasket between flange and manifold. Disconnect air compressor water outlet tube from manifold. Loosen hose clamp, and disengage water pump bypass pipe from thermostat housing. Remove left rear thermostat housing cap screw and lock washer, and lift spark plug wire nipple from screw. Screw heat indicator cable from rear end of manifold. Remove the four cap screws and lock washers which attach manifold to the two cylinder heads, and lift manifold from cylinder heads.

d. **Remove Spark Plugs** (fig. 13) (par. 33).

e. **Remove Cylinder Heads** (fig. 13). Remove the 16 cylinder head cap screws and lock washers. Lift both cylinder heads and gaskets from cylinder block.

49. CARBON REMOVAL.

a. **Remove Cylinder Heads** (par. 48).

b. **Scrape Carbon From Cylinder Block.** Scrape carbon from top of cylinder block. Use care to get all carbon from around valve seats. A putty knife or other flat bladed tool may be used. Do not allow carbon to enter water jacket openings.

ENGINE DATA, MAINTENANCE, AND ADJUSTMENT IN VEHICLE

c. **Scrape Carbon From Cylinder Heads.** Scrape carbon from under side of cylinder heads with a carbon removing tool.

d. **Install Cylinder Heads** (par. 50).

50. CYLINDER HEAD AND GASKET INSTALLATION.

a. **Connect Cylinder Heads to Cylinder Block** (fig. 13). Soak cylinder head gaskets in water for about 15 minutes. Place gaskets in position on top cylinder block, and place front cylinder head in position on its gasket. Place rear cylinder head in position on its gasket. Insert the 16 cylinder head cap screws into their openings on each cylinder head. Place bond strap and heat indicator cable bracket under cap screw third from rear on right-hand side of rear cylinder head. Place spark plug wire nipples under screws second from front and second from rear on left-hand side of rear cylinder head. Place bond strap and spark plug wire nipple on cap screw second from front on left-hand side of front cylinder head. Beginning at center and working toward ends of each cylinder head, tighten cylinder head cap screws to 52½ foot-pounds tension.

b. **Install Water Outlet Manifold** (fig. 13). Use new gaskets, and coat them with a film of No. 2 general purpose grease. Place gaskets in position on cylinder heads. Position manifold on gaskets, and install the four lock washers and nuts which attach manifold to cylinder heads. Screw heat indicator cable into fitting on rear end of manifold. Place lock washer and spark plug wire nipple on left rear thermostat housing screw, and install screw. Work bypass tube hose fitting onto thermostat housing boss, and tighten clamp. Connect air compressor water outlet tube to manifold. Position a new gasket, covered with a film of No. 2 general purpose grease, between water outlet hose flange and manifold. Install the two lock washers and cap screws which attach flange to manifold.

c. **Install Spark Plugs** (fig. 13) (par. 83). Connect wires to adjacent spark plugs. Refer to wiring diagram of ignition system (fig. 43).

d. **Fill Cooling System.** Close drain cocks on radiator outlet elbow and left side of cylinder block. Fill system to capacity (40 qts) with coolant.

e. **Test Installation.** Start engine, and test operation.

f. **Install Engine Hood** (fig. 19). Position hood on floor boards over engine. Install the three flat washers, lock washers, and screws, and engage the two latches.

4. TO 5-TON 4x4 TRACTOR TRUCK (AUTOCAR MODEL U-7144T)

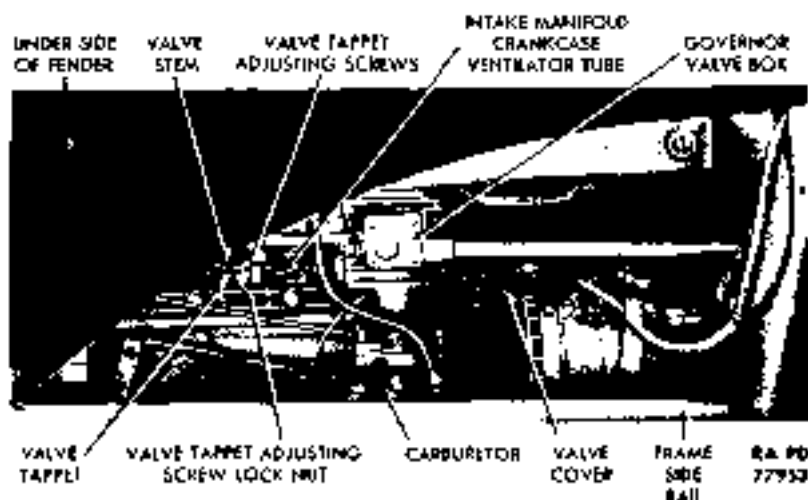

Figure 14 — Valve Tappet Adjustment Provisions

51. VALVE TAPPET ADJUSTMENT.

a. **Remove Splash Shield** (fig. 96). Remove the four wing screws, lock washers, and flat washers which attach splash shield to under side of right front fender. Lift shield from fender.

b. **Disconnect Intake Manifold Crankcase Ventilator Tube** (fig. 14). Unscrew tube from valve on intake manifold.

c. **Remove Valve Covers** (fig. 14). Remove the four valve cover screws, and lift the two valve covers and two gaskets from the cylinder block.

d. **Start Engine.** Start engine and run until the intake manifold is at least warm to the hand. Allow engine to idle during adjustment.

e. **Adjust Tappets** (fig. 14). Beginning at either end of engine, the valves are: exhaust, intake, intake, exhaust, exhaust, intake, intake, exhaust, exhaust, intake, intake, and exhaust, respectively. Beginning with the valve at the extreme front of the engine, loosen the adjusting screw lock nut. Insert a 0.010-inch feeler gage between the lower end of the valve stem and the valve tappet adjusting screw. Turn valve tappet adjusting screw into or out of the valve tappet, until just a light drag can be felt on the feeler gage as it is pulled from between the valve stem and valve tappet adjusting screw. Hold the valve tappet adjusting screw to keep it from turning, and tighten the adjusting screw lock nut. Repeat the process to adjust each of the other valve tappets. Proper clearance for exhaust valves is 0.010 inch, and for the intake valves 0.006 inch.

ENGINE DATA, MAINTENANCE, AND ADJUSTMENT IN VEHICLE

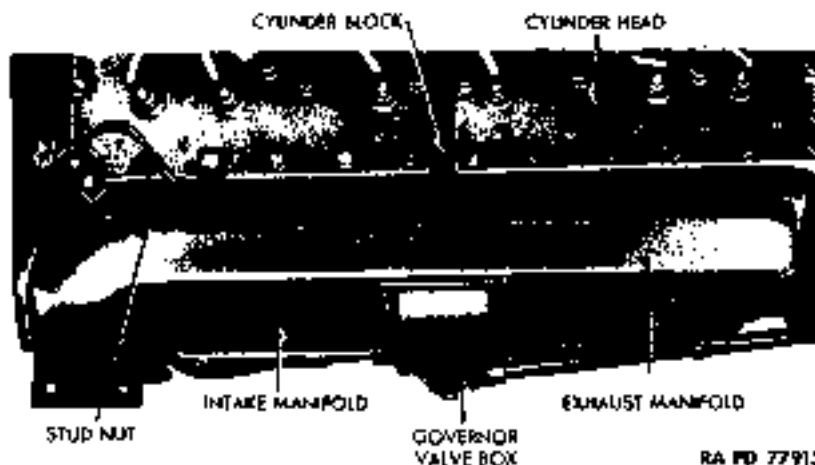

Figure 15 — Engine Manifolds Installed

- f. **Stop Engine.** Turn off ignition switch.
- g. **Replace Valve Covers** (fig. 14). Place valve cover gaskets in position on cylinder block. Place valve covers in position on gaskets. Install the four valve cover flat washers and screws.
- h. **Connect Intake Manifold Crankcase Ventilator Tube** (fig. 14). Install tube to valve on intake manifold.
- i. **Install Splash Shield** (fig. 95). Position shield to under side of fender, and install the four flat washers, lock washers, and wing screws.

52. INTAKE AND EXHAUST MANIFOLDS AND GASKETS.

- a. **Removal.**
 - (1) **REMOVE ENGINE HOOD** (fig. 19) (par. 48).
 - (2) **REMOVE RIGHT-HAND FLOOR BOARD** (fig. 19). Remove the six screws and lock washers which attach floor board to cab, and lift floor board from cab.
 - (3) **REMOVE MANIFOLD SHIELD** (fig. 13). Remove the two nuts, lock washers, and bolts which attach shield to cab frame structure on each end of shield, and remove shield.
 - (4) **REMOVE SPLASH SHIELD** (fig. 95). Remove the four wing screws, lock washers, and flat washers which attach shield to under side of right front fenders. Lower shield from fender.
 - (5) **DISCONNECT CARBURETOR CONTROLS.** Disconnect throttle and choke control wires from carburetor. Pull both cables up through

4- TO 5-TON 4 x 4 TRACTOR TRUCK (AUTOCAR MODEL U-7144T)

opening in manifold, and disconnect carburetor control rod from carburetor throttle lever.

(6) **DETACH GOVERNOR VALVE BOX** (fig. 15). Remove the two cap screws which secure the valve box to intake manifold. Pull valve box, gasket, and attached carburetor free of intake manifold.

(7) **DISCONNECT INTAKE MANIFOLD CRANKCASE VENTILATOR TUBE** (fig. 14). Detach ventilator tube from ventilator valve on the bottom of the intake manifold.

(8) **DISCONNECT EXHAUST PIPE** (fig. 37). Remove the three flange bolts and nuts which secure the exhaust manifold to the exhaust pipe, and slide flange down.

(9) **REMOVE MANIFOLDS AND GASKETS** (fig. 15). Remove the 14 stud nuts and flat washers which hold the intake and exhaust manifolds to the cylinder block, and remove manifolds and gaskets through cab skirt opening.

b. Installation.

(1) **ATTACH GASKETS AND MANIFOLDS TO CYLINDER BLOCK AND CONNECT EXHAUST PIPE** (figs. 15 and 37). Use seven new gaskets. Slide end of exhaust manifold through the engine inspection plate opening and over exhaust pipe, and fit manifolds to the engine block. Secure manifolds to block with stud nuts and flat washers. Connect exhaust pipe to manifold.

(2) **CONNECT INTAKE MANIFOLD CRANKCASE VENTILATOR TUBE** (fig. 14). Attach ventilator tube to ventilator valve at the bottom of the intake manifold.

(3) **ATTACH GOVERNOR VALVE BOX** (fig. 14). Place new valve box gasket, valve box, and attached carburetor in position on the intake manifold, and secure with the two cap screws.

(4) **CONNECT CARBURETOR CONTROLS**. Connect carburetor control rod to carburetor throttle lever. Pull both throttle and choke control cables down through opening between the No. 1 cylinder intake and exhaust flanges, and attach to carburetor.

(5) **TEST INSTALLATION**. Start engine. Inspect manifolds for escaping gas, and note if engine runs satisfactorily.

(6) **INSTALL MANIFOLD SHIELD** (fig. 13). Position shield to cab frame structure. At each end of shield, install the two bolts, lock washers and nuts which secure shield to cab.

(7) **INSTALL RIGHT-HAND FLOOR BOARD** (fig. 19). Position floor board in cab, and install the six lock washers and screws.

(8) **INSTALL ENGINE HOOD** (fig. 19) (par. 50).

(9) **INSTALL SPLASH SHIELD** (fig. 95). Position shield under right front fender, and secure with four flat washers, lock washers, and wing screws.

ENGINE DATA, MAINTENANCE, AND ADJUSTMENT IN VEHICLE

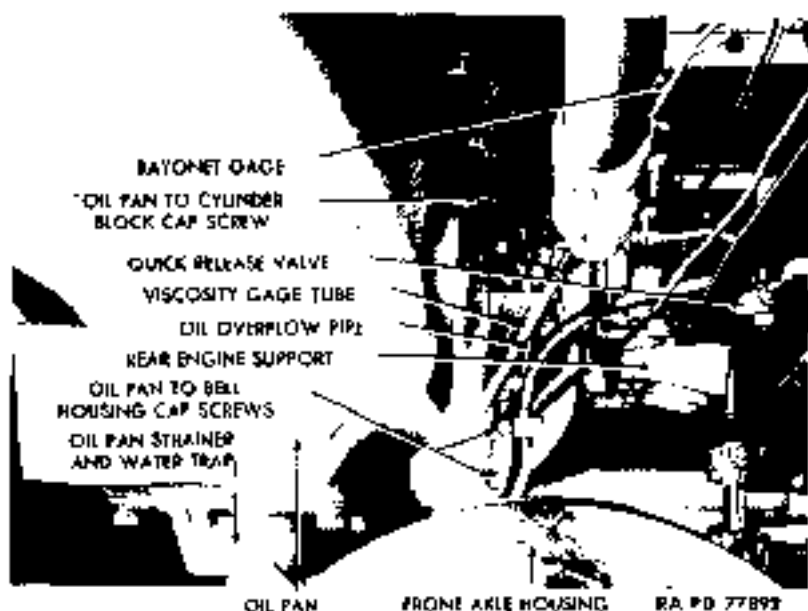

Figure 16 — Oil Pan Installed

53. OIL PAN.

a. Cleaning.

(1) **DRAIN OIL** (fig. 16). Remove drain plug from center of oil pan strainer and water trap, and remove drain plug from rear of oil pan.

(2) **REMOVE STRAINER AND WATER TRAP** (fig. 16). Remove six cap screws and lock washers. Lift strainer, water trap, and gasket from oil pan.

(3) **WIPE SLUDGE FROM INSIDE OIL PAN.** Turn crankshaft so throw arms are horizontal, reach through strainer and water trap hole, and clean interior of pan with a clean cloth.

(4) **CLEAN STRAINER AND WATER TRAP.** Wash the assembly in dry-cleaning solvent, and dry it with a clean cloth.

(5) **INSTALL STRAINER AND WATER TRAP** (fig. 16). Inspect gasket, and replace if torn or crushed. Position serviceable gasket, strainer, and water trap assembly in oil pan. Install the six lock washers and cap screws.

(6) **INSTALL OIL IN CRANKCASE.** Replace both drain plug gaskets and plugs, and install oil (per. 17).

b. Removal.

(1) **REMOVE BAYONET GAGE.** Remove floor board insert (fig. 19), and pull bayonet gage (fig. 16) from its boss in oil pan.

4. TO 5-TON 4 x 4 TRACTOR TRUCK (AUTOCAR MODEL U-7144T)

(2) **DRAIN ENGINE OIL** (fig. 16). Remove drain plug and gasket from oil pan strainer and water trap. Remove drain plug and gasket from rear of oil pan.

(3) **DISCONNECT OIL OVERFLOW PIPE AND VISCOMETER GAGE TUBE** (fig. 16). Lines run from oil filter fitting on left side of oil pan. Unscrew both from fitting.

(4) **REMOVE OIL-PAN-TO-BELL-HOUSING CAP SCREWS** (fig. 16). Three are located on each side and one at lower center, each installed with a lock washer. Remove all.

(5) **REMOVE OIL-PAN-TO-CYLINDER-BLOCK CAP SCREWS** (fig. 16). There are 26 screws, each with a lock washer. Remove all screws.

(6) **REMOVE OIL PAN AND GASKETS** (fig. 16). Lower oil pan to floor, and remove the two side gaskets and front cork. **CAUTION: Do not damage or attempt to remove cork from bell housing.**

c. Installation.

(1) **INSTALL GASKETS.** Coat gaskets with a film of No. 2 general purpose grease. Place side gaskets and front cork in position on oil pan. Spread light coat of same grease on gasket seating surface on cylinder block.

(2) **PLACE OIL PAN IN POSITION** (fig. 16). Position oil pan, using care to keep from dislodging gaskets, and install to crankcase with two cylinder block cap screws and lock washers. Tighten screws only fingertight because their function is to hold oil pan in an approximately correct position.

(3) **INSTALL OIL-PAN-TO-BELL-HOUSING CAP SCREWS** (fig. 16). Tighten the seven screws, each assembled with a lock washer, alternately and securely.

(4) **INSTALL OIL-PAN-TO-CYLINDER-BLOCK CAP SCREWS** (fig. 16). Tighten the 26 screws, each assembled with lock washer, alternately and securely.

(5) **CONNECT OIL OVERFLOW PIPE AND VISCOMETER GAGE TUBE** (fig. 16). These lines run from fitting on left side of oil pan. Tighten both securely.

(6) **INSTALL BAYONET OIL GAGE** (fig. 16). Insert gage into its boss on left side of oil pan.

(7) **INSTALL ENGINE OIL** (par. 17). **CAUTION: Be sure to install both drain plugs and gaskets first.**

(8) **CHECK INSTALLATION.** Start engine, and inspect oil pan for oil leaks.

(9) **INSTALL FLOOR BOARD INSERT** (fig. 19). Position insert on left-hand floor board, and tighten the two wing screws which clamp it in place.

ENGINE DATA, MAINTENANCE, AND ADJUSTMENT IN VEHICLE

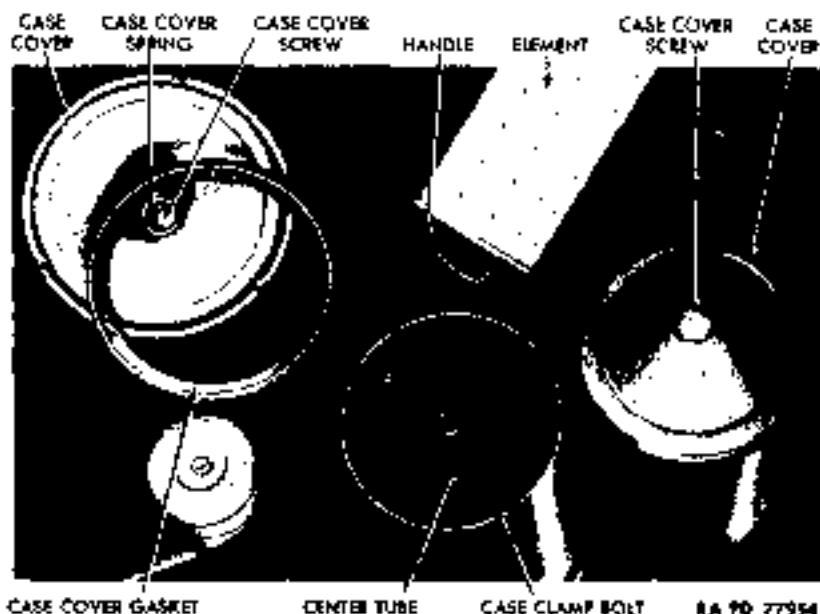

Figure 17 — Oil Filters Partially Disassembled

54. OIL FILTER.

a. Maintenance.

(1) **GENERAL** (fig. 11). Two large filters are secured to a single bracket mounted on the left side of the engine toward the rear. Inspect and replace the two elements as required in paragraph 17.

(2) **ADJUST OIL PRESSURE** (fig. 11). Remove the oil filter pressure relief valve adjusting screw cap from filter bracket. Loosen oil filter pressure relief valve adjusting screw lock nut. Turn oil filter pressure relief valve adjusting screw clockwise to increase pressure, counterclockwise to decrease pressure. Correct oil is 26 pounds minimum to 1,600 revolutions per minute. When correct pressure is obtained, hold adjusting screw, tighten lock nut, and replace cap. *NOTE: Low oil pressure may be caused by bearing wear, low viscosity oil, etc. Therefore, do not adjust pressure until cause of drop has been ascertained and corrected.*

(3) **REMOVE OIL FILTER ELEMENT** (fig. 17). Remove floor board insert (fig. 19), and unscrew oil filter case cover screw. Lift cover and gasket from case. Grasp handle on top of oil filter element, and pull element from case.

(4) **INSTALL OIL FILTER ELEMENT** (fig. 17). Insert oil filter element, handle end up, into oil filter case. Place oil filter case cover

4- TO 5-TON 4 x 4 TRACTOR TRUCK (AUTOCAR MODEL U-7144T)

gasket and cover in position on top of case, and tighten oil filter case cover screw. Check quantity of oil in crankcase, and if low add oil. Install floor board insert.

h. Removal.

(1) **REMOVE FLOOR BOARD INSERT** (fig. 19). Loosen the two wing screws which clamp insert in place, and lift insert from floor board.

(2) **DISCONNECT OIL OVERFLOW PIPE FROM OIL FILTER BRACKET** (fig. 11). This line runs from bracket to fitting on left side of oil pan. Unscrew it from fitting on bracket.

(3) **REMOVE BRACKET-TO-CYLINDER-BLOCK STUD NUTS**. Remove the four nuts and lock washers.

(4) **LIFT OIL FILTER ASSEMBLY FROM CYLINDER BLOCK** (fig. 11). Remove filter, with attached bracket, then remove gasket. **CAUTION: Use care not to injure gasket.**

c. Installation.

(1) **ASSEMBLE GASKET TO BRACKET** (fig. 11). Spread a thin film of No. 2 general purpose grease on both sides of the oil filter bracket gasket, and seat gasket on oil filter bracket.

(2) **ATTACH BRACKET WITH ATTACHED OIL FILTER ASSEMBLY TO CYLINDER BLOCK** (fig. 11). Carefully align dowels on bracket with dowel holes in cylinder block; then install the four bracket-to-cylinder-block stud nut lock washers and nuts.

(3) **CONNECT OIL OVERFLOW PIPE TO FITTING ON BRACKET** (fig. 11). This line runs from bracket to fitting on left side of oil pan. Connect to fitting on bracket.

(4) **TEST INSTALLATION**. Start engine, and inspect oil filter for oil leakage.

(5) **CHECK QUANTITY OF CRANKCASE ENGINE OIL**. Add oil if below required level.

(6) **INSTALL FLOOR BOARD INSERT** (fig. 19). Position insert on floor board, and secure with two wing screws.

55. CRANKCASE VENTILATOR.

a. Maintenance (figs. 50 and 18). Service crankcase ventilator or breather, which is attached to engine crankcase at rear right-hand side. Remove the four wing screws, flat washers, and lock washers which secure right-hand splash shield to fender, and lift off shield. Disengage the two spring clips which hold cover on breather, and lift cover off. Clean out oil cup, and refill to oil level (about $\frac{1}{8}$ pt) with engine oil (par. 17). Install cover and secure with spring clips, then install splash shield. Under severe dust conditions, service breather every few hours.

ENGINE REMOVAL AND INSTALLATION

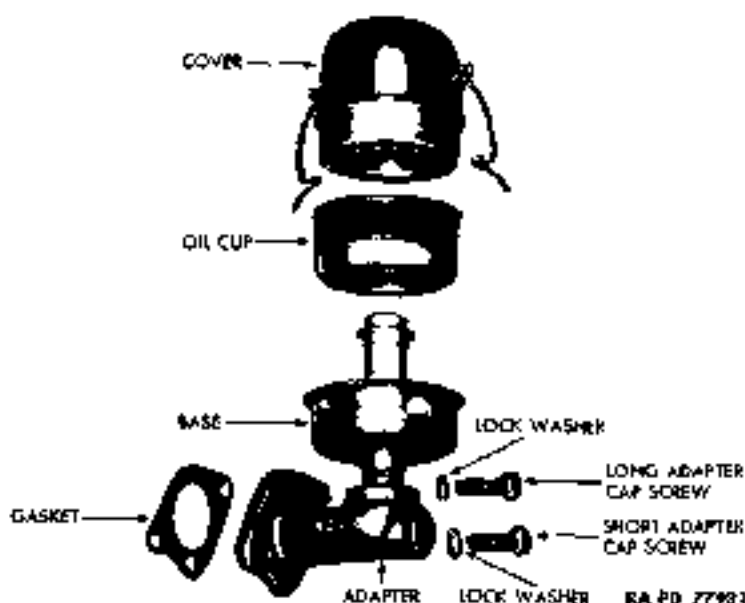

Figure 18 — Crankcase Ventilator Disassembled

b. **Removal** (fig. 50). Remove the four wing nuts, flat washers, and lock washers which secure splash shield to fender, and lift shield from fender. Remove the two cap screws and lock washers which secure crankcase ventilator to crankcase, and lift out assembly and gasket.

c. **Installation** (fig. 50). Check oil cup to see that it is clean and filled with oil to proper level (subpar. a, above). Position gasket and crankcase ventilator to crankcase, and secure with the two cap screws and lock washers. Position right-hand splash shield to fender, and install the four wing screws, flat washers, and lock washers which secure it.

Section XIV

ENGINE REMOVAL AND INSTALLATION

56. REMOVAL.

a. **Position Vehicle.** Place vehicle with wheels blocked under suitable lifting equipment. Have tools, lift hooks, wood blocking, and supports available for use as needed.

b. **Drain Radiator and Cylinder Block.** Open drain cocks at base of radiator outlet elbow (fig. 38) and on left side of cylinder block (fig. 11).

4- TO 5-TON 4x4 TRACTOR TRUCK (AUTOCAR MODEL U-7144T)

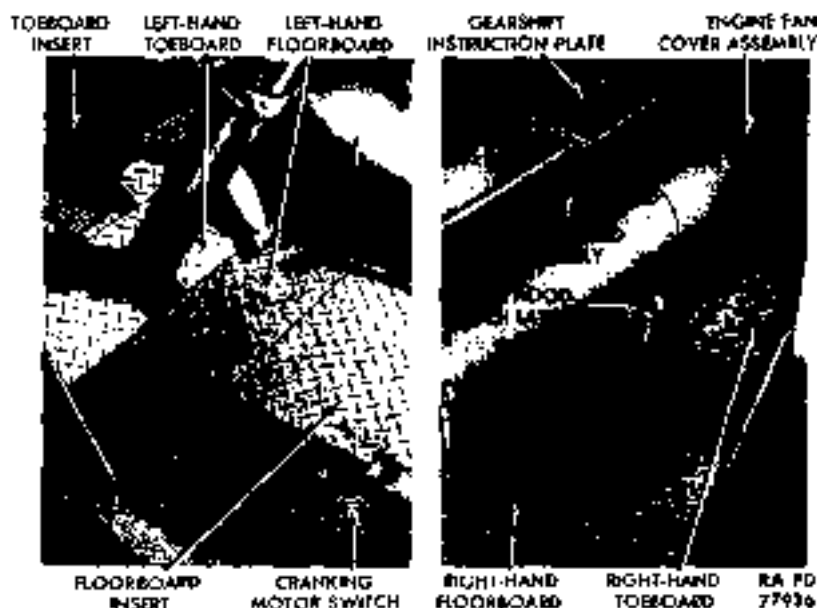

Figure 19 - Floor Boards and Engine Hood

c. **Drain Engine Lubricant** (fig. 7). Remove drain plugs from rear of pan and from sump at center of pan. Drain lubricant from crankcase into suitable container. Replace drain plugs.

d. **Disconnect Batteries** (par. 154).

e. **Remove Engine Hood** (fig. 19). Remove the three screws, flat washers, and lock washers which secure left-hand side of hood to floor board frame. Disengage the two latches on right-hand side of hood.

f. **Remove Toeboards and Floor Boards** (fig. 19). Remove the 20 screws, 4 flat washers, 4 toothed lock washers, and 9 lock washers which secure toeboards and floor boards to cab frame. Lift out toeboards and floor boards.

g. **Remove Cab Top Assembly** (par. 147).

h. **Remove Tire Carrier** (fig. 53). Remove the four nuts, bolts, and eight lock washers on each side which secure tire carrier to frame side rails. Lift tire carrier from vehicle.

i. **Disconnect Filter to Coil Wire From Coil** (fig. 44). Remove the nut and lock washer which secure wire to coil. Remove the screw, lock washer, and clip which secure wire to top of air compressor. Pull wire free.

ENGINE REMOVAL AND INSTALLATION

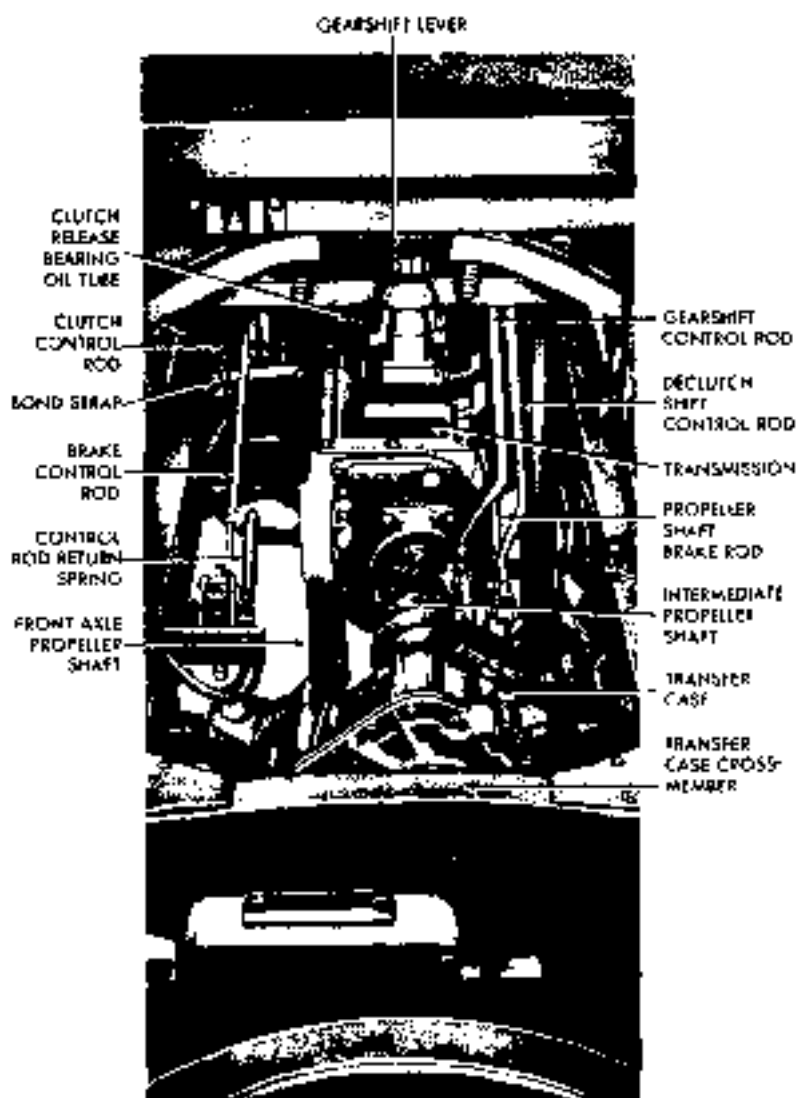

KA PD 77964

Figure 20 - Control Rods Installed

4- TO 5-TON 4x4 TRACTOR TRUCK (AUTOCAR MODEL U.7144T)

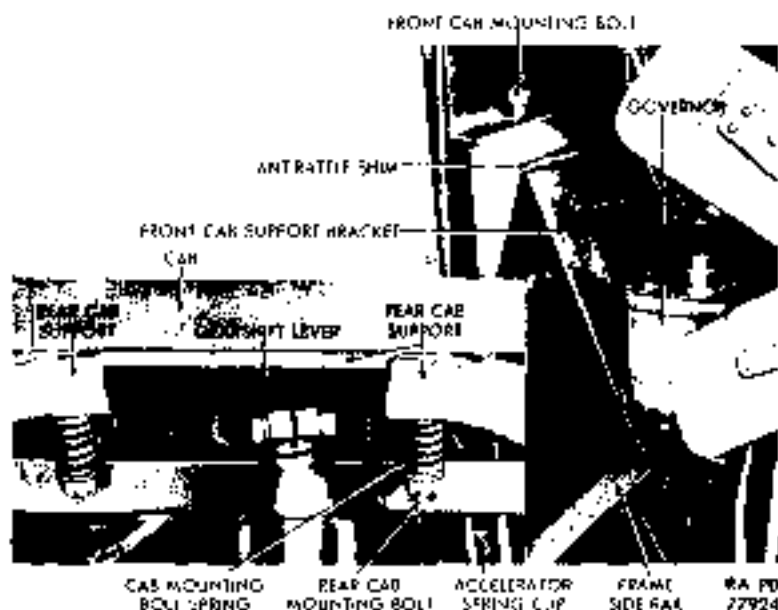

Figure 21 - Cab Attachment Points

- j. Remove Radiator (par. 73).
- k. Disconnect Accelerator Rod From Carburetor (par. 62).
- l. Disconnect Choke and Throttle Controls From Carburetor (par. 62).
- m. Disconnect Tachometer Cable From Tachometer Adapter (fig. 44).
- n. Disconnect Heat Indicator Cable (fig. 13). Loosen nut which secures cable to rear end of water outlet manifold, and pull tube from manifold. Remove the nut, lock washer, clip, and screw which secure cable to engine and to lower end of upper hose connection, and pull cable free.
- o. Disconnect Viscosity Gage Tube (fig. 11). Loosen nut which connects tube to flexible tubing adjacent to top of front oil filter.
- p. Disconnect Oil Pressure Gage. Disconnect pipe at engine end.
- q. Disconnect Generator to Regulator and Ground Wires From Generator (figs. 48 and 47).
- r. Disconnect Fuel Filter to Fuel Pump Fuel Line From Fuel Pump (fig. 31).

ENGINE REMOVAL AND INSTALLATION

- a. **Disconnect Gearshift Control Rod** (fig. 20) (par. 97).
- i. **Disconnect Gearshift Lever** (fig. 20) (par. 97).
- u. **Disengage Instrument Panel** (figs 90 and 104). Remove the seven (two underneath) cross recessed head instrument panel attaching screws and lock washers which secure panel to cowl, and pull panel down.
- v. **Disengage Angle Bracket From Steps**. Remove the two nuts, lock washers, flat washers, and bolts on each side which secure bracket to steps. Remove bracket.
- w. **Disengage Cab Front Support Brackets** (fig. 21). Remove the cotter pin, nut, lock washer, flat washer, spring, and bolt on each side which secure cab to support brackets. Procedure is identical on each of the two sides.
- x. **Disengage Bond Straps** (fig. 109). Remove the nut, bolt, and three lock washers which secure each of the bond straps located as follows: Two at cowl front, two at cowl rear, and one from floor board frame to right side of engine.
- y. **Disengage Air Tube From Windshield Wiper Regulator Valve** (fig. 104). Loosen nut which secures right-hand tube to right-hand windshield wiper regulator valve. Pull tube free.
- z. **Disengage Rear Cab Support Bracket** (fig. 21). Remove the cotter pin, nut, two flat washers, two springs, and bolt on each side which secure cab to rear support brackets. Procedure is identical on each of the two sides.
- aa. **Disengage Cranking Motor Switch to Solenoid Switch Wire** (figs. 51 and 47). Remove nut and lock washer which secure wire to "SW" terminal on cranking motor switch.
- bb. **Disengage Switch to Ammeter Wire and Cranking Motor Switch to Horn Circuit Breaker Wire From Cranking Motor** (figs. 51 and 47). Remove the nut and lock washer which secure these two wires to the "A" terminal on the cranking motor switch. Pull wires free.
- cc. **Remove Gearshift Finish Plate** (fig. 3). Remove the six screws, lock washers, and flat washers which secure gearshift finish plate to floor board frame, and lift plate from vehicle.
- dd. **Remove Steering Wheel** (par. 141).
- ee. **Remove Cab** (fig. 22). Attach rope sling to cab as follows: Tie one end of rope to gun support tube bracket U-bolts at rear right-hand side of truck. Pull other end of rope across cab to the front left-hand side. Open cowl ventilator and push rope through opening, allowing some slack; then pull rope through grab handle on left-hand

4- TO 5-TON 4x4 TRACTOR TRUCK (AUTOCAR MODEL U-7544T)

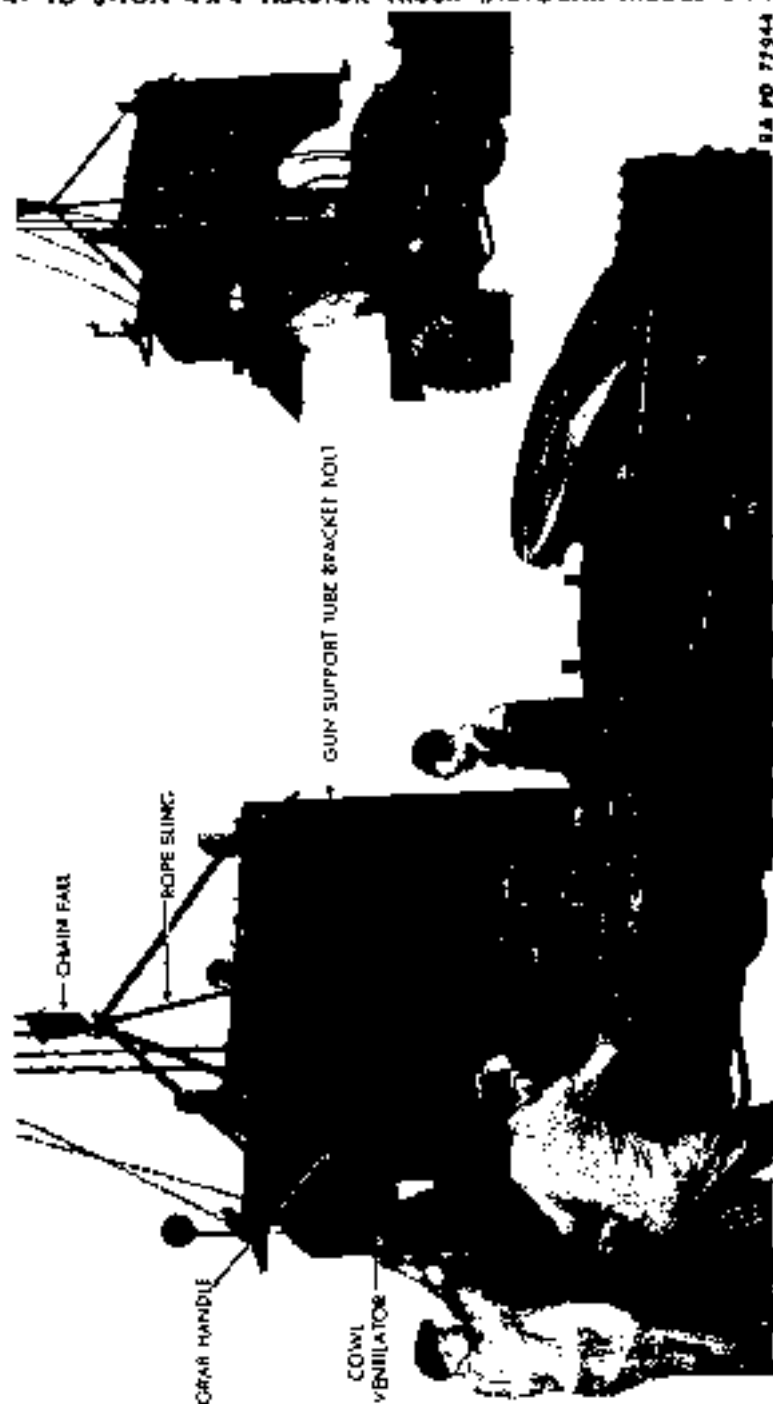

DA PD 77944

Figure 22 - Removing Cab

ENGINE REMOVAL AND INSTALLATION

side. Next, feed rope around gun support tube bracket inside cab at rear left-hand side. Pull rope across cab, and tie to gun support tube bracket U-bolts at front right-hand side, allowing some amount of slack as before. Attach chain fall or other suitable lifting equipment to ropes where they cross. Slowly raise cab from vehicle, and check to see that all attaching wires and parts have been disengaged when cab is about 6 inches above supports. Raise cab high enough to clear steering column, roll truck from under, and lower cab to floor.

- ff. Remove Air Cleaner Pipe (par. 68).
- gg. Remove Exhaust Pipe (par. 69).
- hh. Remove Oil Filter (fig. 11).
- ii. Disconnect Propeller Shaft Brake Rod (fig. 20) (par. 132).
- jj. Remove Fuel Pump (par. 63).
- kk. Disconnect Air Compressor Lines From Air Compressor (par. 112).

ll. Disconnect Front Axle Declutch Shift Control Rod (fig. 20). Remove the cotter pins and clevis pins which secure rod at each end, and remove rod.

mm. Disconnect Clutch Control and Brake Control Rods (fig. 20). Remove the cotter pins and clevis pins which secure rods at each end, and lift out rods.

nn. Remove Intermediate Propeller Shaft (fig. 20) (par. 103).

oo. Disconnect Trailer Lighting Receptacles and Remove Deck Platform (fig. 53) (par. 94).

pp. Remove Transmission (par. 94).

qq. Remove Clutch Pedal Lever, Brake Pedal Lever, and Clutch and Brake Pedal Bracket (fig. 28). Remove the 5 nuts, 10 lock washers, and 5 bolts which secure bracket to frame. Remove bracket and pedal levers as a unit.

rr. Detach Air Compressor Water Inlet Tube (fig. 61). Loosen tube nut on air compressor end, and pull tube free.

ss. Remove Crankcase Ventilator (fig. 50). Remove the two cap screws and lock washers which secure ventilator to engine. Lift assembly from engine, and remove gasket.

tt. Disconnect Crankcase to Governor Oil Line (fig. 12). Loosen nut which secures line to governor, and pull line free.

uu. Attach Rope Sling to Engine (fig. 24). Loop center of rope under crankshaft starting jaw housing. Bring ends of rope diagonally across top of engine, crossing them at center; then pass each end of

4- TO 5-TON 4x4 TRACTOR TRUCK (AUTOCAR MODEL U-7144T)

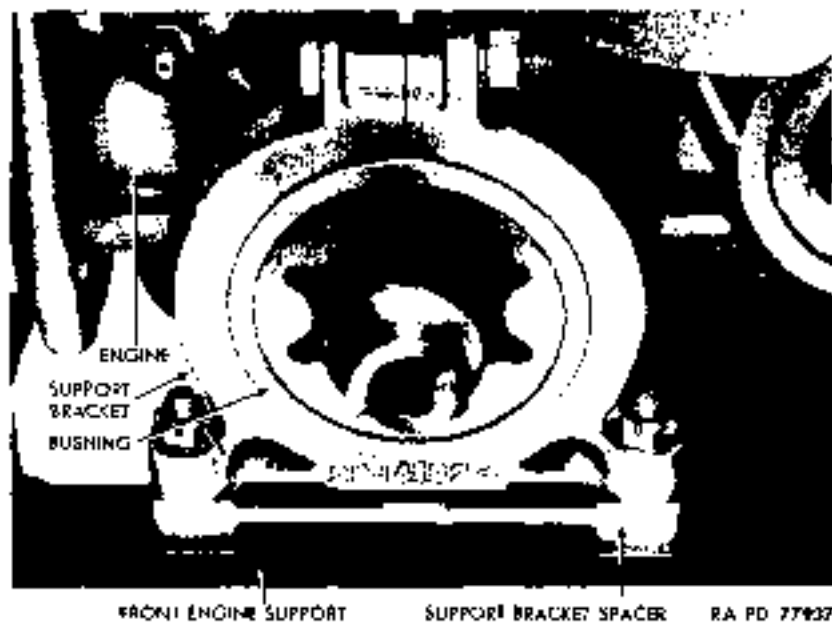

Figure 23 — Front Engine Support Bracket

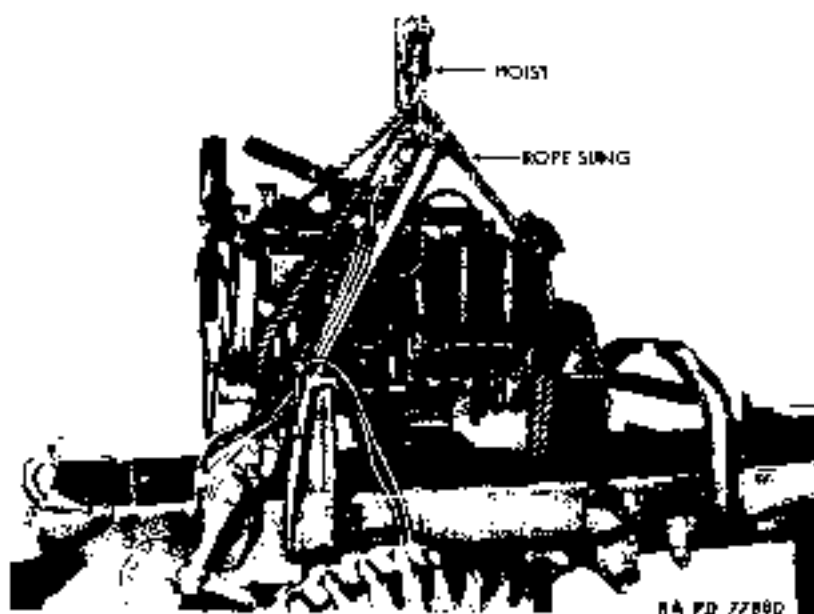

Figure 24 — Removing Engine From Vehicle

ENGINE REMOVAL AND INSTALLATION

rope under ball housing, and tie together at top of bell housing. Loop ends around ropes which run from center of engine to bell housing, pull ropes together, and tie. Place lifting hook under both ropes at center of engine.

vv. **Disconnect Engine Support Bolts** (figs. 23 and 16). Remove the cotter pin, nut, three flat washers, and bolt which secure front engine support bracket to front engine support on each side. Remove the two cotter pins, nuts, six flat washers, two support blocks, and two bolts which secure engine to rear engine support extensions on each side.

ww. **Remove Engine From Vehicle** (fig. 24). Raise engine slowly off supports, checking disengagement of all wires and parts. Shift position of vehicle as necessary to provide clearance. Continue raising engine, and remove from vehicle. Remove front engine support bracket spacer.

xx. **Support Removed Engine**. Lower engine onto engine stand, if available. If not, support engine with wood blocks under bell housing and front engine support bracket.

57. INSTALLATION.

a. **Attach Rope Sling to Engine** (fig. 24) (par. 56 uu).

b. **Position Engine on Vehicle** (fig. 24). Install four new support blocks on rear engine support extensions, and position blocks on extensions. Position support bracket spacer on front engine support. Raise engine to position at front of vehicle, and then lower slowly to front support and rear support extensions. **CAUTION: Maintain adequate clearance for parts and assemblies.**

c. **Install Engine Support Bolts** (figs. 23 and 16). Install the 2 bolts, 6 flat washers, 2 nuts, and 2 cotter pins which secure engine support bracket to front engine support. Install the 4 bolts, 12 flat washers, 4 nuts, and 4 cotter pins which secure engine to rear support extensions.

d. **Install Transmission** (par. 95). **NOTE: Disregard this step if engine and transmission are being installed as a unit.**

e. **Install Intermediate Propeller Shaft** (fig. 20) (par. 103).

f. **Install Propeller Shaft Brake Rod** (fig. 20) (par. 132).

g. **Connect Front Axle Declutch Shift Control Rod** (fig. 20). Position rod between declutch shift hand lever and declutch shift transfer lever, and secure with clevis pin and cotter pin at each end.

h. **Install Gearshift Control Rod** (fig. 20). (par. 97).

4. TO 3-TON 4 x 4 TRACTOR TRUCK (AUTOCAR MODEL U-7144T)

i. Install Crankcase Ventilator (fig. 50). Using new gasket, position ventilator to engine, and secure with the two cap screws and lock washers.

j. Connect Air Compressor Lines (par. 112).

k. Connect Crankcase to Governor Oil Line (fig. 12). Position line to compressor, and tighten nut which secures it.

l. Connect Fuel Filter to Fuel Pump Fuel Line (par. 63).

m. Install Oil Filter (fig. 11).

n. Install Fuel Pump (par. 63).

o. Attach Air Compressor Water Inlet Tube (fig. 61). Position tube to compressor, and tighten nut which secures it to fitting.

p. Install Cab (fig. 22). Attach rope to cab as described in paragraph 56. Attach hoist to rope and raise into position over engine. Lower cab slowly, and guide into position on supporting brackets. Remove hoist and attaching rope.

q. Connect Cab to Cab Front Support Brackets (fig. 21). Install the bolt, flat washer, spring, toothed lock washer, nut, and cotter pin which secures cab on each side to support brackets. Procedure is identical on each of the two sides.

r. Connect Cab to Cab Rear Support Bracket (fig. 21). Install the bolt, two springs, two flat washers, nut, and cotter pin on each side which secures cab to rear support bracket. Procedure is identical on each of the two sides.

s. Install Gearshift Finish Plate (fig. 3). Position plate to floor board frame between cab seats, and secure with the six screws, lock washers, and flat washers.

t. Install Steering Wheel (par. 141).

u. Install Air Cleaner Pipe (par. 68).

v. Install Exhaust Pipe (par. 69).

w. Install Clutch Pedal Lever, Brake Pedal Lever, and Clutch and Brake Pedal Bracket (fig. 28). Position bracket to frame. Install the five bolts, two toothed lock washers, eight lock washers, and five nuts which secure bracket to frame.

x. Connect Clutch Control and Brake Control Rods (fig. 20). Position rods, and secure with clevis pin and cotter pin at each end of each rod.

y. Attach Radiator Lower Hose Assembly (pars. 73 and 75).

z. Connect Cranking Motor Switch to Solenoid Switch Wire (figs. 51 and 47). Position wire to "SW" terminal on cranking motor switch, and secure with nut and lock washer.

ENGINE REMOVAL AND INSTALLATION

aa. **Connect Switch to Ammeter Wire, and Cranking Motor Switch to Horn Circuit Breaker Wire** (figs. 51 and 47). Position both wires to "A" terminal on cranking motor switch, and secure with nut and lock washer.

bb. **Connect Generator to Regulator, and Ground Wires to Generator** (pars. 87 and 88).

cc. **Connect Air Tube to Windshield Wiper Regulator Valve** (fig. 104). Position tube to right-hand wiper regulator valve, and tighten nut.

dd. **Connect Bond Straps** (fig. 109). Remove rust and dirt from bond strap connections. Install the bolt, three lock washers, and nut which secure each of the five bond straps (par. 56).

ee. **Connect Instrument Panel to Cowl** (figs. 90 and 104). Position cowl to panel, and install the seven cross recessed screws (two underneath) and lock washers which secure panel to cowl.

ff. **Install Gearshift Lever** (fig. 20) (par. 97).

gg. **Install Angle Plate Bracket**. Position bracket under angle plates. Install the two bolts, flat washers, lock washers, and nuts which secure bracket to plates.

hh. **Install Deck Platform and Trailer Lighting Receptacle** (fig. 53) (par. 94).

ii. **Connect Viscosity Gauge Tube** (fig. 11). Position tube to flexible tubing adjacent to top of front oil filter, and tighten nut which secures the two portions of the tube together.

jj. **Connect Heat Indicator Cable** (fig. 13). Insert end of cable in rear end of water outlet manifold, and tighten nut which secures it. Install the screw, clip, lock washer, and nut which secures clip to engine and to lower end of upper hose connection.

kk. **Attach Tachometer Cable** (par. 171).

ll. **Connect Choke and Throttle Controls** (par. 62).

mm. **Connect Accelerator Rod** (par. 62).

nn. **Install Radiator** (par. 73).

oo. **Connect Filter-to-roll Wire** (fig. 44). Position wire to coil, and secure with lock washer and nut. Install the screw, toothed lock washer, and clip which secures wire to top of air compressor.

pp. **Install Tire Carrier** (fig. 53). Position tire carrier on frame side rails, and install the four bolts, eight lock washers, and four nuts on each side which secure carrier to frame.

qq. **Install Cab Top Assembly** (par. 147). **NOTE:** *This applies only to open-cab type vehicle.*

4. TO 5-TON 4 x 4 TRACTOR TRUCK (AUTOCAR MODEL U-7144T)

rr. Install Toeboards (fig. 19). Position toeboards, and floor boards to cab frame, and secure with the 20 screws, 4 flat washers, 4 toothed lock washers, and 9 lock washers.

rs. Install Engine Hood (fig. 19). Position hood over engine. Secure left-hand side with the three screws, lock washers, and flat washers, and right-hand side with the two latches.

rt. Connect Batteries (par. 154).

ru. Replace Engine Lubricant (fig. 16). Install drain plugs at rear of oil pan and in bottom of sump at center of oil pan. Remove cap from oil filler, install lubricant, and replace cap.

rv. Replace Cooling Fluid (figs. 38 and 11). Close drain cocks at base of water pump inlet connection and at end of extension pipe from cylinder block. Remove radiator cap, fill system, and replace cap.

Section XV

CLUTCH

58. DESCRIPTION AND TABULATED DATA.

a. Description (fig. 25). The clutch, located between the engine and transmission is the heavy-duty, single plate, dry-disk type. The clutch disk is positioned between the face of the engine flywheel and the clutch pressure plate assembly.

b. Tabulated Data.

Manufacturer	W. C. Lipe
Model	Z-42-S cover and Z-15-2 driven plate

59. MAINTENANCE AND ADJUSTMENT.

a. Maintenance. Check free pedal movement before the clutch disengages. Minimum distance must be not less than three-fourths inch to avoid overheating and slipping. If clearance is less than three-fourths inch adjust the distance between the rear face of clutch throw-out sleeve and the rear face of flywheel ring to between $1\frac{1}{8}$ inches and $1\frac{3}{16}$ inches. See paragraph 17 for lubrication maintenance.

b. Adjustment (figs. 26 and 27). Remove cotter pin and clevis pin connecting clutch control rod and clutch pedal lever. Remove inspection plate beneath clutch housing. Block clutch disengaging lever in full release position and turn engine slowly with hand crank until adjusting strap (with shim packs) is accessible. With clutch in a released position back off the six adjusting nuts about five full turns.

CLUTCH

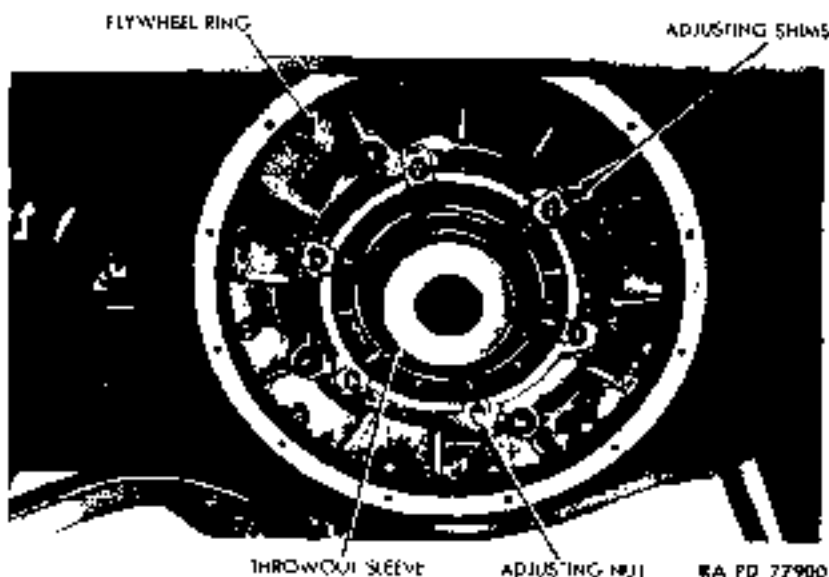

Figure 25 — Clutch Installed — Transmission Removed



Figure 26 — Clutch Adjustment Provisions

4- TO 5-TON 4 x 4 TRACTOR TRUCK (AUTOCAR MODEL U-7144T)

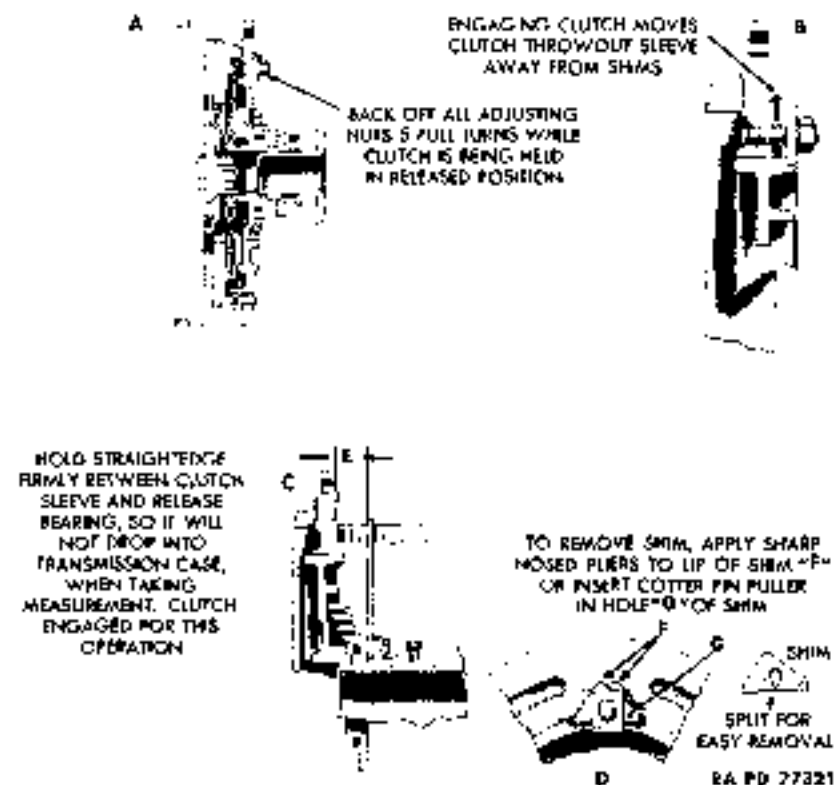

Figure 27 - Steps in Adjusting Clutch

Remove blocking from disengaging lever, which will move clutch throw-out sleeve back away from shims. Remove shims as necessary to obtain $1\frac{1}{16}$ - to $1\frac{3}{16}$ -inch clearance between faces of clutch throw-out sleeve and flywheel ring (fig. 25). **NOTE:** Removing one shim from each pack will reduce clearance $\frac{1}{16}$ inch. To secure full contact between pressure plate and driven plate, always remove or install the same number of shims from each pack. Test contact of trunnion fork throw-out levers against trunnion lugs by inserting feeler gage between each lug and lever at the same time. Levers must engage lugs evenly at both sides, and, if necessary, can be bent to engage evenly.

60. CLUTCH LINKAGE.

a. Removal.

(1) DISCONNECT CLUTCH CONTROL ROD AND CLUTCH PEDAL LEVER (fig. 28). Remove the cotter pin and clevis pin which secures rod to lever.

CLUTCH

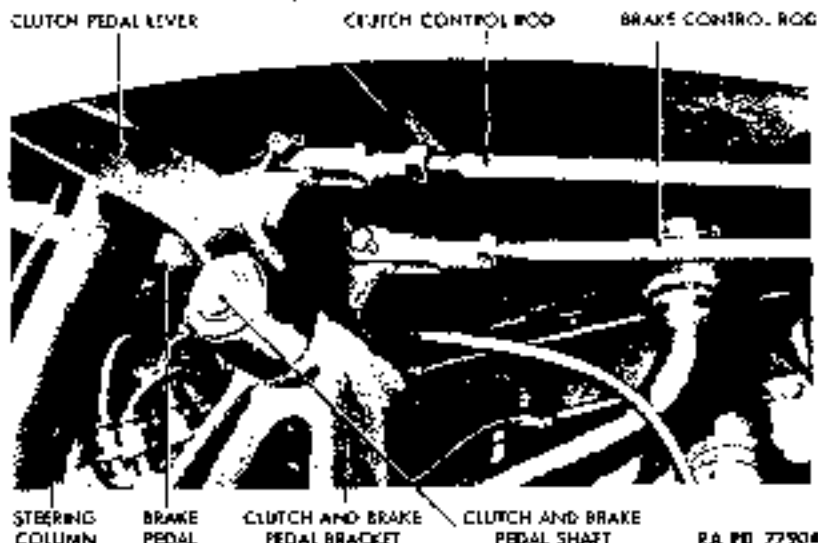

Figure 28 - Clutch, Brake Pedals, and Linkage

(2) REMOVE CLUTCH PEDAL LEVER FROM CLUTCH AND BRAKE PEDAL SHAFT (fig. 28). Remove taper pin, lock ring, and flat washer which connects lever to shaft. Slide shaft over away from clutch side, and remove pedal lever.

(3) DISCONNECT CLUTCH CONTROL ROD, CLUTCH THROW-OUT SHAFT LEVER, AND CLUTCH THROW-OUT SHAFT LEVER SPRING LINK (fig. 52). Remove cotter pin and clevis pin which secures control rod to throw-out shaft lever. Remove control rod and spring link.

(4) DISCONNECT CLUTCH THROW-OUT SHAFT LEVER FROM CLUTCH THROW-OUT SHAFT (fig. 52). Remove the hex cap screw and spring which secures shaft lever to shaft. Slide lever from shaft, remove Woodruff key, and remove shaft.

(5) DISCONNECT CLUTCH THROW-OUT SHAFT STOP LEVER FROM CLUTCH THROW-OUT SHAFT (fig. 52). Remove the hex cap screw, spring, and Woodruff key which secures stop lever to throw-out shaft, and slide lever from shaft.

b. Installation.

(1) INSTALL CLUTCH THROW-OUT SHAFT STOP LEVER ON CLUTCH THROW-OUT SHAFT (fig. 52). Position lever on shaft, insert Woodruff key, and secure with cap screw and spring.

(2) INSTALL CLUTCH THROW-OUT SHAFT, AND CONNECT THROW-OUT SHAFT LEVER ON CLUTCH THROW-OUT SHAFT (fig. 52). Install shaft, insert Woodruff key, and fit lever on clutch end of shaft. Secure with the hex cap screw and spring.

4- TO 5-TON 4 x 4 TRACTOR TRUCK (AUTOCAR MODEL U-7144T)

(3) **CONNECT CLUTCH THROW-OUT SHAFT LEVER SPRING LINK AND CLUTCH CONTROL ROD TO CLUTCH THROW-OUT SHAFT LEVER** (fig. 52). Insert clevis pin through holes at the end of spring link, control rod, and shaft lever, and secure with cotter pin.

(4) **INSTALL CLUTCH PEDAL LEVER ON CLUTCH AND BRAKE PEDAL SHAFT** (fig. 28). Slide pedal shaft over away from clutch pedal side. Position pedal lever on end of shaft, and secure with the flat washer, lock ring, and taper pin.

(5) **CONNECT CLUTCH CONTROL ROD AND CLUTCH PEDAL LEVER** (fig. 28). Position clutch control rod to pedal lever, insert clevis pin, and secure with cotter pin.

(6) **ADJUST CLUTCH** (par. 59).

Section XVI

FUEL SYSTEM

61. DESCRIPTION.

a. The fuel system consists of a fuel tank, fuel filter, fuel pump, carburetor, air cleaner, and governor assembly. Fuel stored in the tank runs through fuel lines to the filter and on to the fuel pump. The pump forces fuel to the carburetor, where it is mixed with air which has been cleaned by the air cleaner. The mixture then is drawn into the combustion chamber of the engine by the vacuum produced by the down stroke of the pistons.

62. CARBURETOR.

a. **Description and Tabulated Data.**

(1) **DESCRIPTION** (fig. 29). The carburetor is located on right-hand side of engine between engine and frame. It can be reached from under the truck or through opening obtained by removing splash shield from under right front fender. It is the updraft, single-venturi type. Its function is to supply the proper mixture of fuel and air to the combustion chambers through the intake manifold.

(2) **TABULATED DATA.**

Manufacturer	Zenith
Model	457-2
Identification plate	2C7024-0-9797

b. **Adjustment.**

(1) **GENERAL.** Three adjustments can be made without disassembling the carburetor. These are throttle stop screw adjustment, idling mixture adjustment, and intermediate and high speed mixture adjustment.

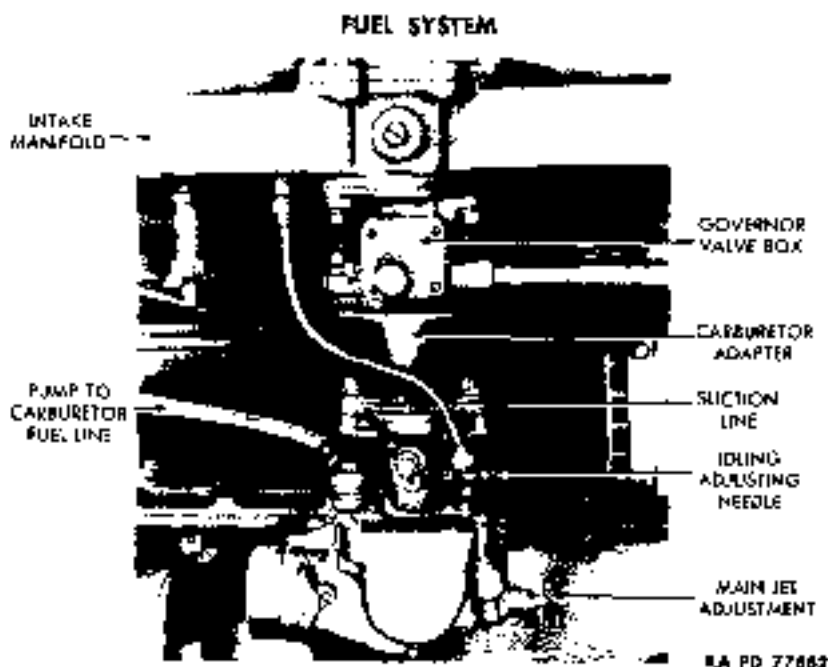

Figure 29 - Carburetor

(2) **ADJUST THROTTLE STOP SCREW.** Start engine and allow it to run during adjustment. Remove splash shield from under right-hand front fender. Wait until intake manifold is at least warm to the hand, then close throttle and adjust throttle stop screw on carburetor until engine idles at 350 revolutions per minute. Stop engine, and install splash shield unless other carburetor adjustments are to be made.

(3) **ADJUST IDLING MIXTURE** (fig. 29). Adjust throttle stop screw (step (2) above). Leave splash shield off and engine running. Turn in idling adjusting needle near top of carburetor until engine slows. Back out needle until engine attains maximum speed for throttle setting. Set throttle stop screw so that engine idles at 350 revolutions per minute. Stop engine, and install splash shield unless further carburetor adjustment is to be made.

(4) **ADJUST INTERMEDIATE AND HIGH SPEED MIXTURES** (fig. 29). Start engine, and set throttle so that tachometer registers 550 revolutions per minute. Remove splash shield from under right-hand front fender. Wait until intake manifold is at least warm to the hand, then turn main jet adjustment on under side of carburetor in (clockwise) until engine slows down. Open adjustment (turn counterclockwise) until engine slows down. Turn adjustment to a position halfway between these two extremes. Stop engine, and install splash shield.

4- TO 5-TON 4 x 4 TRACTOR TRUCK (AUTOCAR MODEL U-7144T)

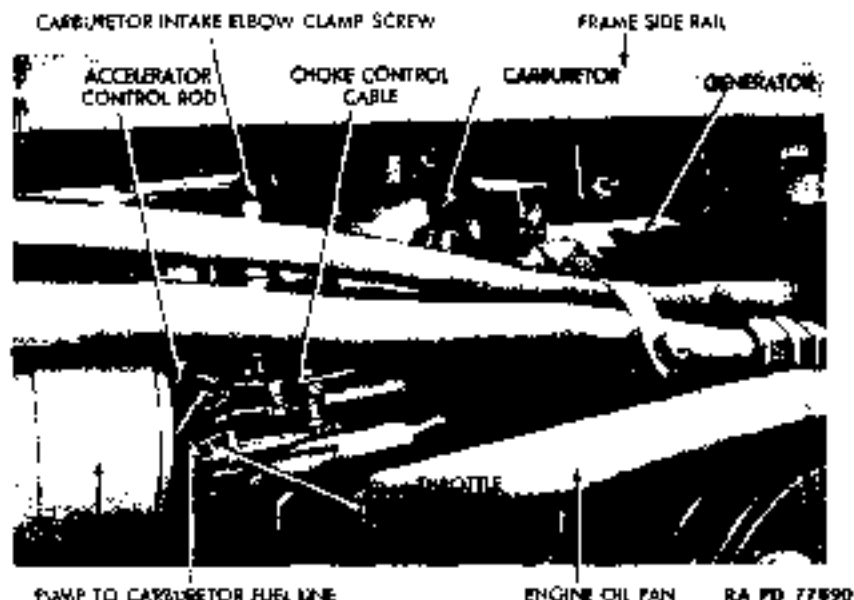

Figure 30 - Carburetor Connections

c. Removal.

(1) **DISCONNECT CONTROLS FROM CARBURETOR** (fig. 30). Remove splash shield from under right-hand front fender. Disconnect choke control cable, throttle control cable, and accelerator control rod from carburetor.

(2) **DISCONNECT AIR CLEANER FROM CARBURETOR** (fig. 30). From under truck, loosen carburetor intake elbow clamp screw nut. Disengage elbow from carburetor.

(3) **DISCONNECT LINES FROM CARBURETOR** (fig. 30). Working through splash shield opening, disconnect pump to carburetor fuel line from its fitting on carburetor. Disconnect carburetor to manifold suction line (fig. 29) from its fitting on carburetor.

(4) **DETACH CARBURETOR** (fig. 29). Working through splash shield opening, remove the two cap screws and lock washers which attach carburetor to carburetor adapter. Lift carburetor and gasket from adapter.

d. Installation.

(1) **ATTACH CARBURETOR** (fig. 29). Place gasket and carburetor in position on carburetor adapter, and install the two lock washers and cap screws which hold carburetor to adapter.

(2) **CONNECT LINES TO CARBURETOR** (figs. 29 and 30). Connect

FUEL SYSTEM

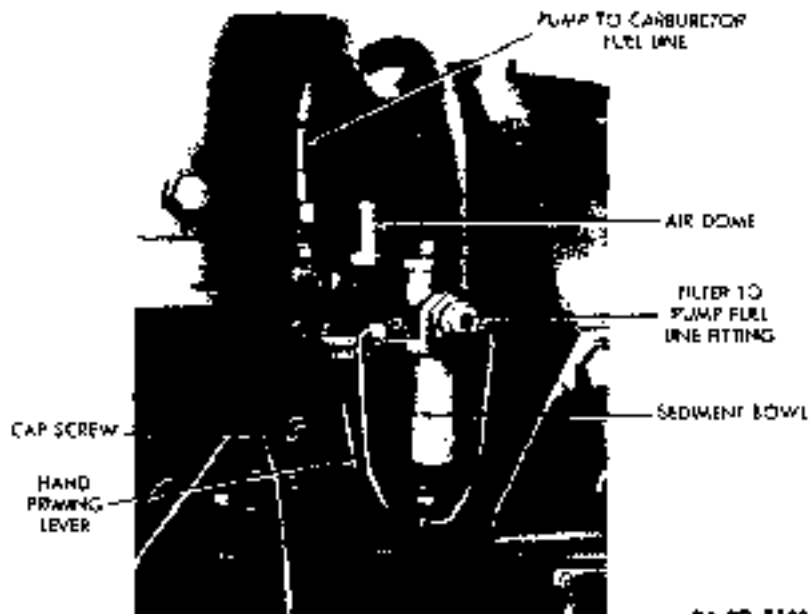

SA PD 77901

Figure 31 - Fuel Pump Installed

fuel line to its fitting on inside rear of carburetor. Connect carburetor to manifold suction line to its fitting on outside front of carburetor.

(3) **CONNECT CONTROLS TO CARBURETOR** (fig. 30). Push in choke control on dash, open carburetor air shutter or choke valve, and attach choke control cable to air shutter lever. Attach throttle control cable to carburetor throttle lever. Be sure throttle is closed when throttle control on dash is in. Connect accelerator control rod to throttle lever.

(4) **CONNECT AIR CLEANER** (fig. 30). Position carburetor intake elbow on rear of carburetor, and tighten intake elbow clamp screw nut.

(5) **TEST INSTALLATION.** Start engine, and test for satisfactory engine performance.

(6) **INSTALL SPLASH SHIELD** (fig. 95). Position splash shield under right front fender. Install the four flat washers, and wing screws which secure shield to fender. Install bond strap from shield to frame, if removed.

63. FUEL PUMP.

a. Description and Tabulated Data.

(1) **DESCRIPTION** (fig. 31). The fuel pump is mounted on the left side of the engine, approximately level with the top of the chassis frame. It can be reached through the floor board insert

4- TO 5-TON 4x4 TRACTOR TRUCK (AUTOCAR MODEL U-7144T)

assembly opening, through the left-hand splash shield opening, or from under the truck. The pump is the diaphragm type, with a sediment bowl and hand priming lever, and is operated by a rocker arm on the engine camshaft. Its function is to pump gasoline from the fuel tank to the carburetor.

(2) TABULATED DATA.

Manufacturer	AC
Model	D
Manufacturer's symbol	1534471
Pump pressure	2 to 3 $\frac{3}{4}$ lb

b. Maintenance (fig. 31). When lubricating the chassis, remove and empty sediment bowl. Wipe bowl clean with a cloth, inspect bowl seat nut and gasket, and replace if worn, broken, or torn. After installation, work hand priming lever, and check for leakage.

c. Removal.

(1) **REMOVE FLOOR BOARD INSERT (fig. 19).** Loosen the two wing screws which clamp insert to floor board, and lift insert out.

(2) **DISCONNECT FUEL LINES (fig. 31).** Unscrew filter to fuel pump line, and pump to carburetor line, from fittings on pump.

(3) **DETACH PUMP (fig. 31).** Remove the two cap screws and lock washers which attach pump to cylinder block. Lift pump and gasket from cylinder block.

d. Installation.

(1) **ATTACH PUMP TO ENGINE (fig. 31).** Position gasket and pump on cylinder block, and install the two lock washers and cap screws which secure pump to cylinder block.

(2) **CONNECT FUEL LINES (fig. 31).** Connect filter to fuel pump line to fitting at sediment bowl end of pump. Connect pump to carburetor line to fitting adjacent to air dome.

(3) **TEST INSTALLATION.** Work hand priming lever (fig. 31) to fill pump and fuel lines. Start engine, run for 15 minutes at 550 revolutions per minute, and check engine performance.

(4) **INSTALL FLOOR BOARD INSERT (fig. 19).** Place insert in position on floor board, and tighten the two wing screws which clamp insert to floor board.

64. FUEL FILTER.**a. Description and Tabulated Data.**

(1) **DESCRIPTION (figs. 32 and 33).** The fuel filter is mounted on the outside of main frame left side rail, and can be reached through an opening immediately above the left-hand lower step. Gasoline flows from the fuel tank to fuel pump through the filter,

FUEL SYSTEM

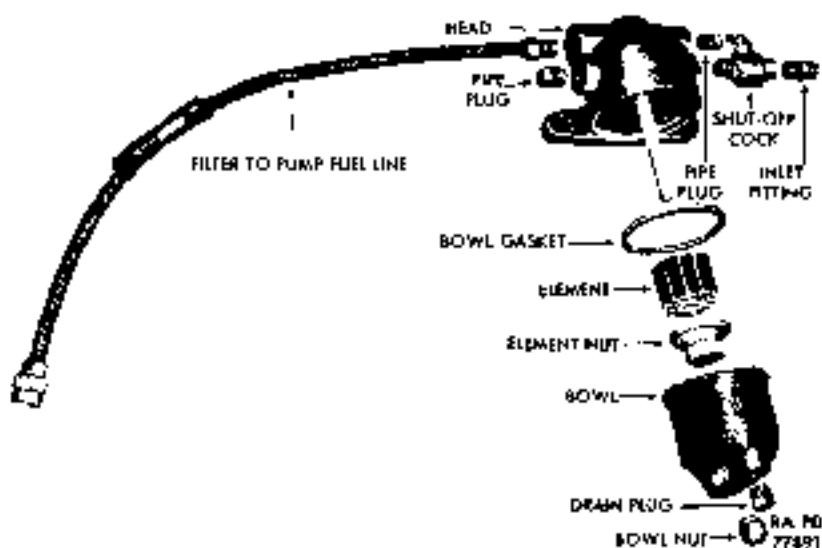

Figure 32 — Fuel Filter Disassembled

entering the filter through an inlet fitting into a metal bowl. From the bowl, it passes through a cylindrical, laminated filtering element and out through an outlet fitting. A shut-off cock is provided on the inlet fitting.

(2) TABULATED DATA.

Manufacturer	Zenith
Model	F328
Element	Cylindrical and laminated

h. Maintenance (fig 32). Service fuel filter when lubricating chassis. Remove bowl nut from bottom center of bowl. Lower bowl and bowl gasket from filter head. Unscrew element nut and lower element from stud. Wash all parts in dry-cleaning solvent, and dry with compressed air. Inspect element and gasket, and replace broken, bent, or torn parts. Place element in position on stud, and install element nut. Position gasket on top of bowl, position bowl on under side of filter head, and install bowl nut. Loosen one of the two pipe plugs on side of filter head and start engine. Tighten pipe plug when fuel drips from it.

c. Removal.

(1) **DISCONNECT FUEL LINES (fig 33).** Unscrew tank to filter fuel line and filter to fuel pump line from filter fittings.

4- TO 5-TON 4x4 TRACTOR TRUCK (AUTOCAR MODEL U-7144T)

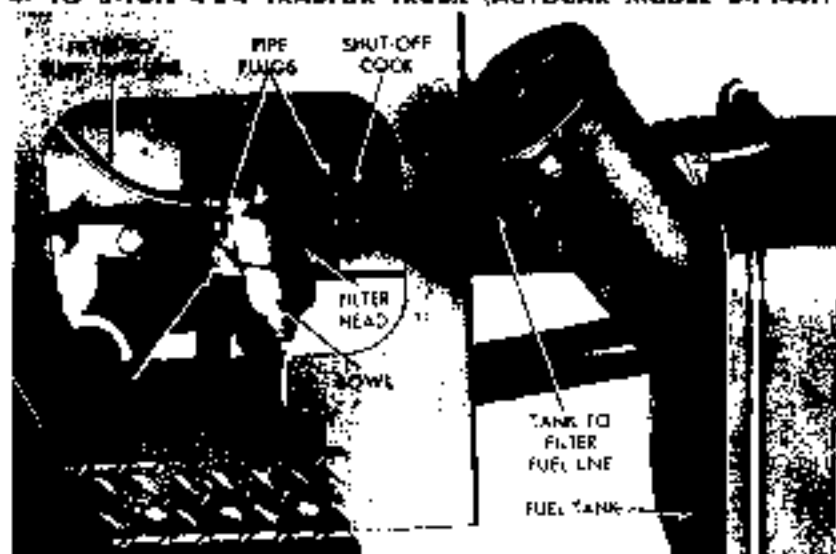

RA PD 77940

Figure 33 - Fuel Filter Installed

(2) **DETACH FILTER** (fig. 33). Remove the two nuts, lock washers, and bolts which attach filter to frame side rail.

d. **Installation.**

(1) **ATTACH FILTER TO PUMP** (fig. 33). Place filter in position on frame left side rail. Install the two bolts, lock washers, and nuts which secure filter to frame.

(2) **CONNECT FUEL LINES** (fig. 33). Connect tank to filter line to rear filter fitting. Connect filter to fuel pump line to fitting on front of filter.

(3) **FILL FILTER WITH FUEL** (fig. 33). Loosen one of the two drain plugs on filter head. Start engine, and run until fuel drips from drain plug, then tighten drain plug.

65. FUEL TANK.

a. **Description and Tabulated Data.**

(1) **DESCRIPTION** (fig. 34). The 60-gallon, welded sheet metal fuel tank is located outside the chassis frame ahead of the left rear wheel. It is supported by two cast brackets bolted to the frame side rail and extending out over the tank. It is secured to the brackets by two steel straps. The fuel outlet elbow and gage connection are on top of the tank, protected by a wood shield bolted to the brackets. A drain plug is located on the under side of the tank. A filler

FUEL SYSTEM

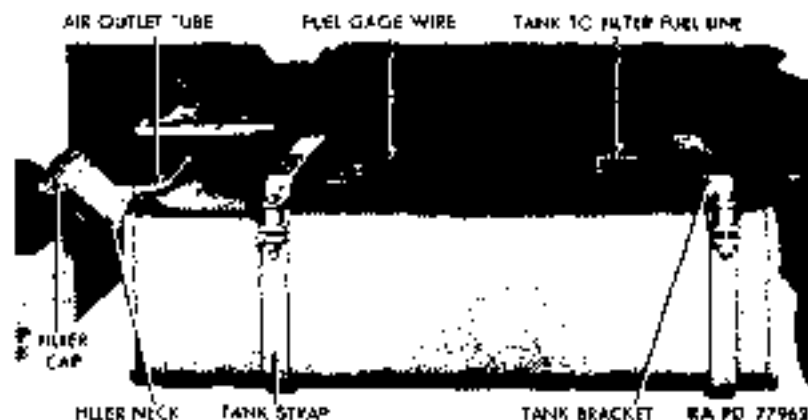

Figure 34 - Removing Fuel Tank Shield

neck, equipped with an external air outlet tube, is located near the upper left corner. The neck contains a removable tank filler sleeve functioning as a strainer, and a chain attaches the tank cap to the filler sleeve.

(2) TABULATED DATA.

Capacity	60 gals
Mounting	Left-hand frame side rail

b. Maintenance (fig 34).

(1) Twist tank filler sleeve, and pull from filler neck at time of chassis lubrication. Clean sleeve with dry-cleaning solvent, and dry with compressed air. Install sleeve in filler neck, and check tightness of all strap and mounting bolts.

(2) During cold weather especially, always keep tank nearly full to reduce condensation. Whenever water appears in fuel filter or in fuel pump sediment bowl, remove drain plug from fuel tank. Catch gasoline in clean containers, and strain through a chamois skin or other filter which will remove water. Install drain plug, and refill tank.

(3) Remove gravel, stones, rust, scale, or other foreign matter from tank. **NOTE:** Foreign matter in tank is indicated by clogged tank to filter fuel line, rapid fouling of fuel filter, plugging of drain, or by noise in fuel tank. Remove tank (subpar. c, below). Twist tank filler sleeve, and pull from filler neck. Empty foreign matter from tank through filler neck, rinse tank with dry-cleaning solvent, and inspect for leaks or other damage. Replace tank if damaged. Install tank (subpar. d, below).

4- TO 5-TON 4 x 4 TRACTOR TRUCK (AUTOCAR MODEL U-71447)

c. Removal (fig. 34).

(1) **DRAIN GASOLINE.** Remove drain plug from tank sump, and catch gasoline in clean containers. Install drain plug.

(2) **REMOVE TANK SHIELD** (fig. 2). Remove the six cap screws, lock washers, and flat washers which attach shield to tank brackets. Lift shield from vehicle.

(3) **DISCONNECT FUEL GAGE WIRE.** Make sure ignition switch is off. Remove nut and lock washer which attach fuel gage wire to terminal on tank unit. Remove screw and lock washer which hold wire clip to gage tank unit, and pull wire from tank unit.

(4) **DISCONNECT FUEL LINE.** Unscrew tank to filter fuel line from outlet fitting on tank.

(5) **SUPPORT TANK.** Support tank with a hardwood block placed across top of a jack.

(6) **REMOVE TANK STRAPS.** Remove nut, two lock washers, and bolt which attach outer end of a tank strap to tank bracket; then remove cap screw and lock washer which attach inner end of same strap to bracket. Repeat this procedure to remove other strap.

(7) **LOWER TANK TO GROUND.** Lower jack sufficiently to free tank, and lift tank to ground. Do not rest tank on its top or bottom as damage to sump or fittings may result.

d. Installation (fig. 34).

(1) **POSITION TANK.** Place a jack on floor, midway between tank brackets, and a hardwood board across top of jack. Set fuel tank on board, and raise jack to support tank in position under brackets.

(2) **INSTALL TANK STRAPS.** Place a tank strap in position around end of tank, and install lock washer and cap screw which secure inner end of strap to bracket. Install bolt, two lock washers, and nut which hold outer end of strap to bracket. Repeat this procedure to install other strap. Remove jack and hardwood board from under tank.

(3) **CONNECT FUEL LINE.** Position fuel line against fitting on top of tank, and tighten sleeve nut.

(4) **CONNECT FUEL GAGE WIRE.** Place wire on its terminal on fuel gage tank unit, and install lock washer and nut which secure it. Install lock washer and screw which secure wire clip to tank unit.

(5) **TEST INSTALLATION.** Make sure all fittings and plugs are tight, and fill tank with gasoline. Check fittings and plugs for leakage.

(6) **INSTALL TANK SHIELD** (fig. 2). Position wooden tank shield on top of tank brackets, and install six lock washers and cap screws.

INTAKE AND EXHAUST SYSTEM

66. FUEL LINES.

a. **Description.** Gasoline is conducted from fuel tank to carburetor through three fuel lines. Tank to filter fuel line (fig. 34) and pump to carburetor fuel line is flexible woven metal (fig. 32). Brass sleeve coupling nuts are used throughout.

b. Maintenance.

(1) **CLEANING.** If fuel line becomes plugged, disconnect both ends of line, and apply compressed air at one end to blow obstruction from line. **CAUTION:** Do not apply air to one line unless other end is disconnected.

(2) **CUTTING AND BENDING TUBING AND INSTALLING FITTINGS** (fig. 72). If a complete tubing assembly is not available for replacement purposes, cut new tubing to same length as original with ends cut clean and square. Bend tubing on jig to shape of original part. Place a sleeve coupling nut and ferrule over each end, and install tubing (subpar. d, below).

c. **Removal** (figs. 34, 29, and 32). Completely unscrew sleeve coupling nut from each end of tubing. Remove clips along tubing (step (2) above). Work tubing from vehicle.

d. **Installation** (figs. 34, 29, and 32). Place tubing in position occupied by original installation. Connect sleeve coupling nut at each end of tubing. Install clips (step (2) above) along length of tubing.

Section XVII

INTAKE AND EXHAUST SYSTEM

67. DESCRIPTION.

a. The intake system consists of an oil-bath type carburetor air cleaner, which cleans the air before it is drawn into the carburetor.

b. The exhaust system carries the burned gas from the engine to the atmosphere. The system consists of an exhaust pipe (exhaust manifold to muffler), muffler, and tail pipe (exhaust stack).

68. AIR CLEANER.

a. Description and Tabulated Data.

(1) **DESCRIPTION** (figs. 35 and 36). The air cleaner is attached to a bracket mounted outside the right-hand frame side rail at rear of the engine, and is accessible through an opening in the cab skirt. It is connected to the carburetor by an air pipe. Foreign particles are fil-

4. TO 5-TON 4x4 TRACTOR TRUCK (AUTOCAR MODEL U-7144T)

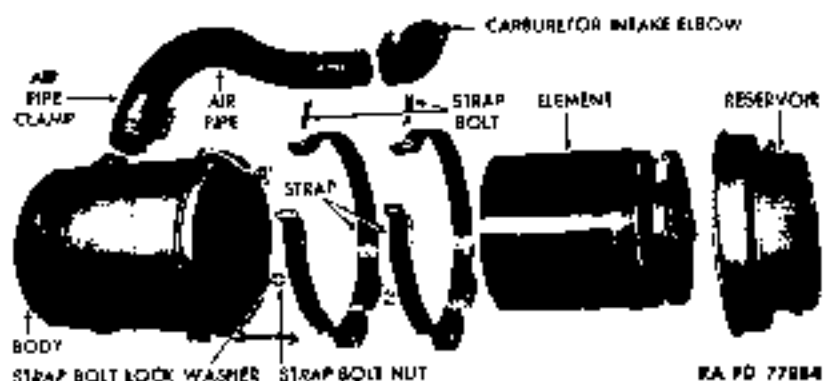

Figure 35 - Carburetor Air Cleaner Disassembled

tered out of the air as it passes through a mass of fine metal shavings with an oil bath underneath.

(2) TABULATED DATA

Manufacturer United Specialties Co.
Model T1 95-2540B
Oil capacity 3 pt

b. Maintenance (figs. 35 and 36). Remove and refill reservoir at intervals indicated in paragraph 17.

c. Removal.

(1) DISCONNECT AIR PIPE FROM CARBURETOR (fig. 36). Loosen carburetor intake elbow clamp screw (fig. 35). Pull elbow from carburetor.

(2) REMOVE CLEANER FROM BRACKET (fig. 36). Remove the four nuts, toothed lock washers, and bolts which secure air cleaner straps to bracket. Remove cleaner.

d. Installation.

(1) INSTALL AIR CLEANER (fig. 36). Position cleaner straps to bracket. Secure with the four bolts, toothed lock washers, and nuts.

(2) CONNECT AIR PIPE TO CARBURETOR (fig. 36). Fit pipe to carburetor, and tighten elbow clamp screw.

69. EXHAUST PIPE

a. Description and Tabulated Data.

(1) DESCRIPTION (fig. 37). Exhaust pipe is attached to exhaust manifold at one end and muffler at the other end. Its purpose is to conduct exhaust gases from the engine exhaust manifold to the muffler.

INTAKE AND EXHAUST SYSTEM

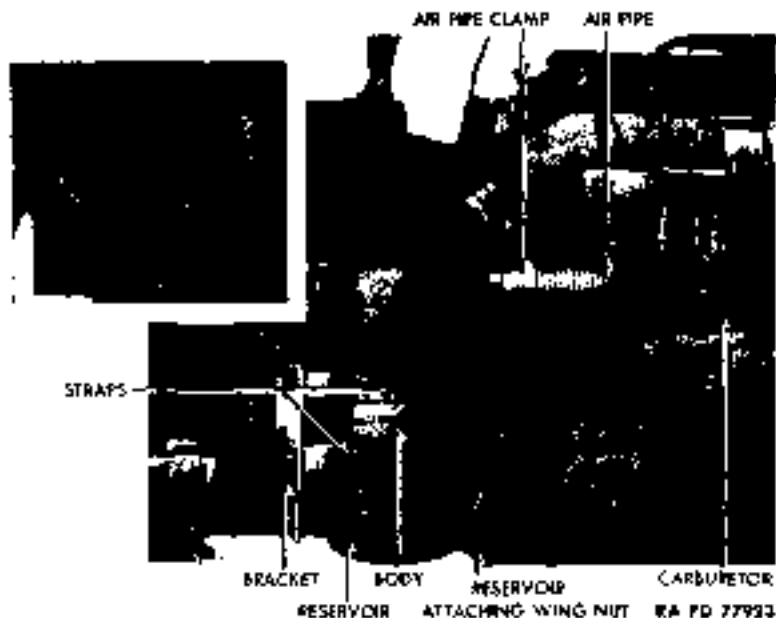

Figure 34 - Carburetor Air Cleaner Installed

Attachment to the exhaust manifold is provided by a flange and gasket which fits over exhaust pipe and clamps it to manifold. Attachment to muffler is made by inserting exhaust pipe into the split tube attached to muffler. Tube is tightened to pipe by means of a clamp.

(2) TABULATED DATA.

Material Steel tubing
 Diameter 2 1/4 in.

b. Removal (fig. 37).

(1) REMOVE MUFFLER (par. 70).

(2) DISCONNECT FLANGE. Remove splash shield from under right front fender. Remove the three nuts, six lock washers, and three bolts which secure flange to exhaust manifold. Loosen screw which clamps flange to exhaust pipe. Slide flange from manifold. Remove exhaust pipe.

c. Installation (fig. 37).

(1) INSTALL EXHAUST PIPE (fig. 37). Use new gasket. Position exhaust pipe, at flange end, to manifold. Secure with the three bolts, six lock washers, and three nuts. Tighten cap screw which secures flange to exhaust pipe. Tighten nuts alternately, a few turns at a time, until all are tight.

(2) INSTALL MUFFLER (par. 70).

4- TO 5-TON 4x4 TRACTOR TRUCK (AUTOCAR MODEL U-7144T)

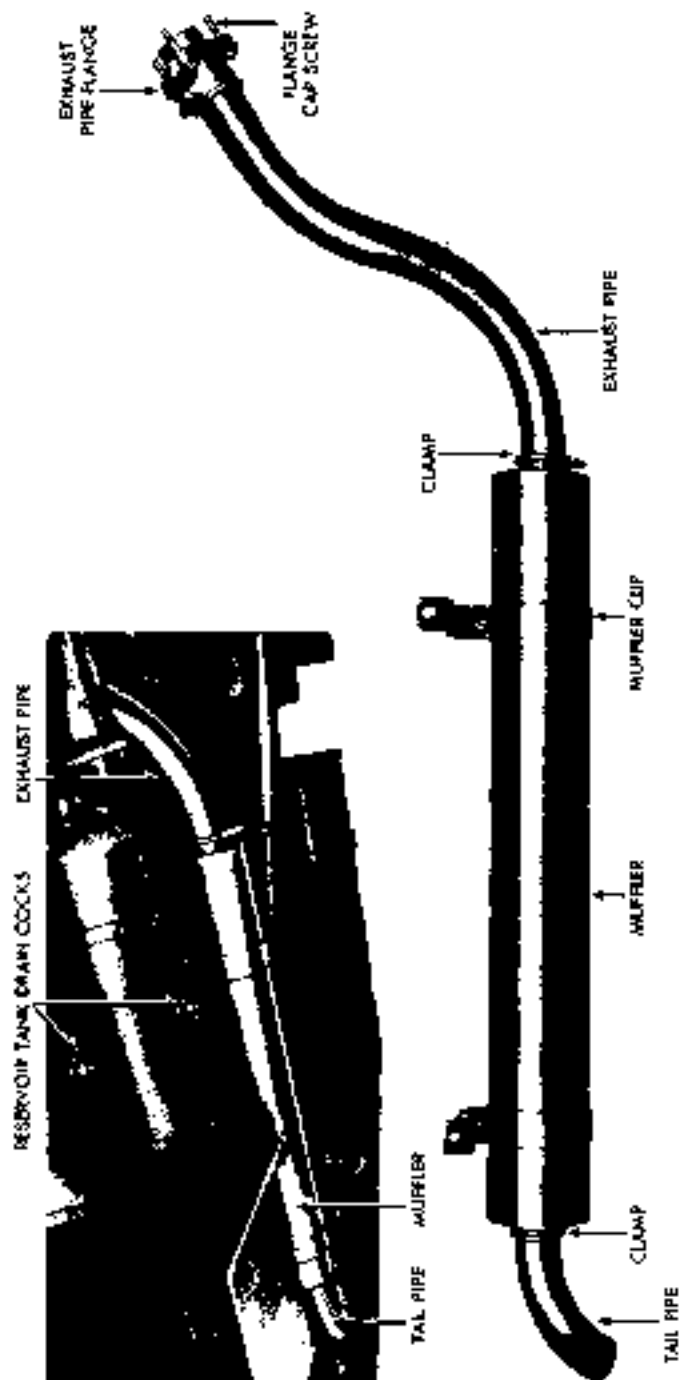

RA PB 77916

Figure 37 - Exhaust System

INTAKE AND EXHAUST SYSTEM

70. MUFFLER.

a. Description and Tabulated Data.

(1) **DESCRIPTION** (fig. 37). Muffler is attached by two clips to right-hand frame side rail below and to the inside of the two air reservoir tanks and the tool box. Its purpose is to muffle engine exhaust noises. It consists of a heavy welded sheet iron cylinder containing baffle plates. Two sleeves, front and rear, attach it to the exhaust pipe and tail pipe, respectively.

(2) TABULATED DATA.

Material	Terneplate, welded
Main cylinder length	44 in.
Main cylinder diameter	5½ in.
Sleeve diameter	3 in.

b. Removal (fig. 37).

(1) **REMOVE TAIL PIPE** (par. 71).

(2) **REMOVE MUFFLER.** Mark ends of muffler to facilitate correct installation. Loosen the bolt, nut, and lock washer which secures sleeve to exhaust pipe. Remove the two nuts, lock washers, and bolts which secure muffler clips to frame side rail. Pull muffler from exhaust pipe.

c. **Installation** (fig. 37). Position muffler to frame side rail (note markings for correct installation). Slide muffler sleeve over end of exhaust pipe. Install the two bolts, nuts, and lock washers which secure muffler clips to frame side rail. Tighten bolt, nut, and lock washer which secures sleeve to exhaust pipe. Install tail pipe (par. 71).

71. TAIL PIPE.

a. Description and Tabulated Data.

(1) **DESCRIPTION** (fig. 37). Tail pipe is attached to rear of muffler. It consists of a curved iron pipe which emits exhaust gases to the atmosphere at a point directly in front of the right rear wheels.

(2) TABULATED DATA.

Material	Steel tubing
Diameter	2¼ in.

b. **Removal** (fig. 37). Loosen tail pipe clamp. Pull tail pipe from muffler.

c. **Installation** (fig. 37). Insert tail pipe into muffler sleeve. Position pipe so that discharge end is in front of right rear wheels. Tighten clamp securing pipe to muffler.

Section XVIII

COOLING SYSTEM

72. DESCRIPTION.

a. **Description.** The cooling system consists of three major units: radiator, water pump, and fan. The pump draws coolant from the radiator, circulates it under pressure through and around water jackets in the cylinder block and cylinder head, and then returns it to the radiator for recirculation. Circulation is controlled by a thermostat located in the water outlet manifold on the cylinder head. Capacity of the cooling system is 40 quarts. One drain cock on the cylinder jacket above water pump, and another drain cock on the outlet elbow at bottom of radiator, control the openings for draining fluid from cooling system.

73. RADIATOR.

a. **Description and Tabulated Data.**

(1) **DESCRIPTION** (fig. 38). The radiator consists of a tube and fin type core and two tanks. In circulating through the radiator, the cooling fluid enters through an inlet elbow at the top and leaves bottom of radiator through an outlet elbow. The radiator is secured to frame crossmember at bottom and to cowl at top. The cooling system is filled through an opening at top center of radiator. A thermostatic controlled opening and overflow pipe are located at top of radiator.

(2) **TABULATED DATA.**

Make	Long
Type	Tube and fin

b. **Removal.**

(1) **REMOVE LEFT-HAND SPLASH SHIELD** (fig. 95). Remove the four wing screws, lock washers, and pin washers which secure shield to cowl through fenders. Remove shield.

(2) **DRAIN RADIATOR AND CYLINDER BLOCK** (figs. 11 and 38). Remove radiator cap. Open the drain cock on cylinder jacket above water pump and the drain cock on bottom of radiator outlet, and drain.

(3) **REMOVE RADIATOR BRUSH GUARD** (fig. 1). Remove the 4 bolts, nuts, and 8 lock washers which secure light wires to inside base of brush guard, and pull wires free. Remove the 4 screws, nuts, and 8 lock washers which secure blackout marker light to each side of brush guard assembly. Remove the 8 bolts, nuts, and 16 lock

COOLING SYSTEM

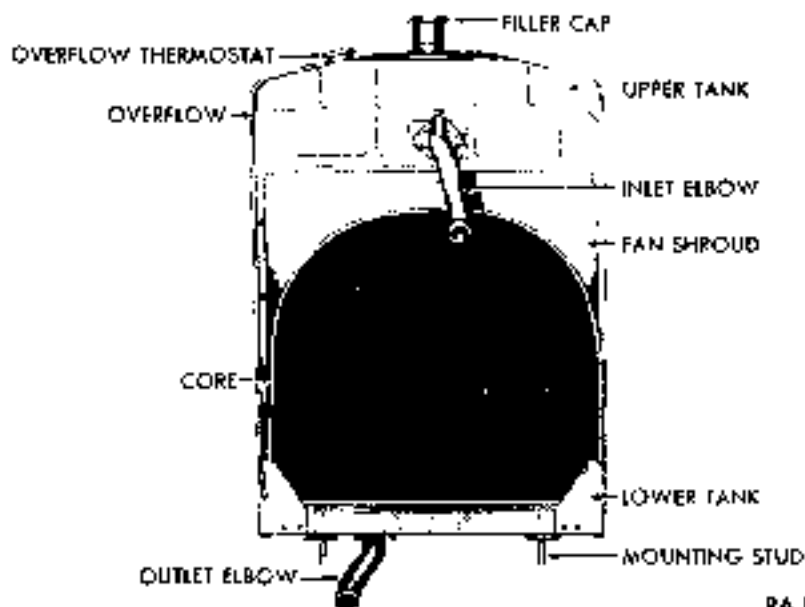

RA PD 77961

Figure 28 - Radiator

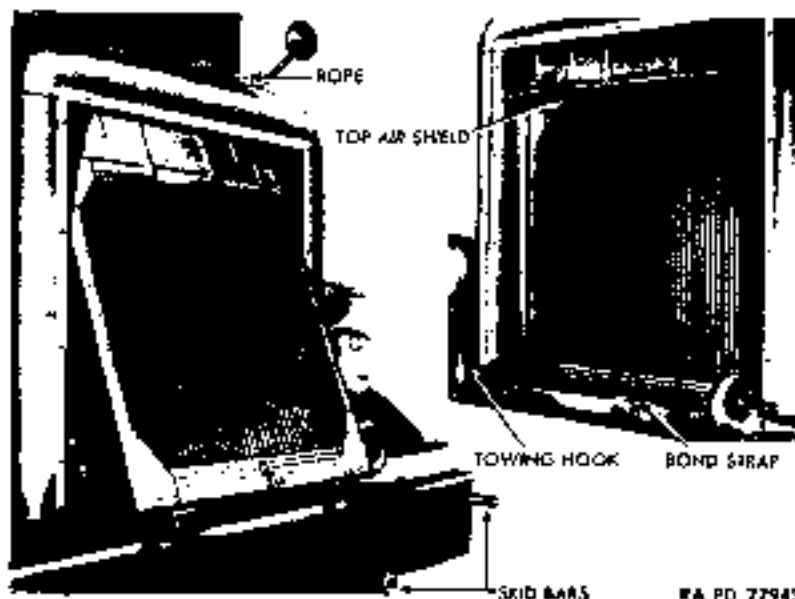

RA PD 77943

Figure 29 - Radiator Removal

4. TO 5-TON 4 x 4 TRACTOR TRUCK (AUTOCAR MODEL U-7144T)

washers which secure brush guard to fender bracket on each side. Remove the 11 bolts, 6 nuts, and 17 lock washers which secure brush guard assembly to cowl. Remove brush guard assembly.

(4) **REMOVE ENGINE HOOD** (fig. 19). Disengage the two latch catches on right-hand side of hood. Remove the three screws, flat washers, and lock washers which secure left side of hood to floor board. Remove hood.

(5) **DISCONNECT RADIATOR INLET ELBOW** (fig. 38). Remove the two cup screws and lock washers which secure inlet elbow and gasket to radiator. Pull elbow free of radiator, and remove gasket.

(6) **REMOVE RADIATOR OUTLET ELBOW** (fig. 38). Remove the two cup screws and lock washers which secure elbow and gasket to bottom of radiator. Pull elbow free of radiator, and remove gasket.

(7) **DISCONNECT RADIATOR FROM FRAME BRACKETS** (fig. 38). Remove the two cotter pins, nuts, four flat washers, and two springs which secure mounting studs of radiator to frame crossmember on each side. Remove the bolt, nut, and two lock washers which secure bond strap to front base of radiator (fig. 39). Remove radiator support insulators.

(8) **DISCONNECT TOP AIR SHIELD** (fig. 39). Remove the four screws and lock washers which secure top air shield to side air shields, and remove shield.

(9) **REMOVE TOWING HOOKS** (fig. 94) (par. 149).

(10) **REMOVE RADIATOR** (fig. 39). Place two skid bars between bottom of radiator and front frame crossmember. Attach rope to radiator filler neck. Raise radiator with skid bars, and guide neck through radiator filler door. Pull bottom of radiator out and lower to floor.

c. Installation.

(1) **POSITION RADIATOR IN COWL** (fig. 39). Position support insulators on radiator support brackets. Lift radiator to position in front of cowl. Place skid bars under radiator. Attach rope through radiator filler door to radiator filler neck. Tilt top of radiator forward. Guide neck through filler neck as radiator is lifted with skid bars. Push bottom of radiator to position on frame front support member brackets. Remove skid bars and rope.

(2) **CONNECT RADIATOR TO FRAME BRACKETS** (fig. 38). Install the two springs, four flat washers, two nuts, and cotter pins which secure radiator mounting studs to brackets. Install the bolt, two lock washers, and nut which secure bond strap to front base of radiator (fig. 39).

(3) **ATTACH TOP AIR SHIELD** (fig. 39). Position shield to top of side air shields. Secure with the four screws and lock washers.

COOLING SYSTEM

(4) **ATTACH RADIATOR OUTLET ELBOW** (fig. 38). Use new gasket. Position elbow to radiator, and secure with the two cap screws and lock washers.

(5) **INSTALL RADIATOR INLET ELBOW** (fig. 38). Use new gasket. Position elbow to radiator, and secure with the two cap screws and lock washers.

(6) **INSTALL TOWING HOOKS** (fig. 94) (par. 149).

(7) **INSTALL ENGINE HOOD** (fig. 19). Position hood on floor board. Secure left-hand side with the three screws, flat washers, and lock washers, and engage the two catch latches which secure right-hand side.

(8) **INSTALL RADIATOR BRUSH GUARD** (fig. 1). Position guard to cowl. Install the 11 bolts, 6 nuts, and 17 lock washers which secure brush guard to cowl. Install the 8 bolts, nuts, and 16 lock washers which secure brush guard to fender bracket on each side. Position blackout marker light to each side of brush guard, and secure with the 4 screws, nuts, and 8 lock washers. Install the 4 bolts, nuts, and 8 lock washers which secure light wires to inside base of brush guard.

(9) **FILL COOLING SYSTEM**. Shut off the drain cock on cylinder jacket above water pump (fig. 11) and the drain cock at bottom of radiator outlet elbow (fig. 38). Remove filler cap, fill system, and install filler cap.

(10) **INSTALL LEFT-HAND SPLASH SHIELD** (fig. 95). Position shield to cowl and fender, and install the four plain washers, lock washers, and wing screws which secure shield to cowl.

74. WATER PUMP.

a. Description and Tabulated Data.

(1) **DESCRIPTION** (fig. 40). The water pump is the centrifugal type, driven by a horizontal pump shaft which is chain-coupled to the distributor drive shaft. It is mounted on engine at center of left side, and is coupled to the pump inlet elbow, water pump bypass tube, air compressor water inlet tube, and pump outlet tube. The pump assembly includes packing nuts for adjustment.

(2) TABULATED DATA.

Manufacturer	Hercules
Model	16859-DS
Type	Centrifugal
Drive	Chain coupling
Location	Left-hand side of engine

b. **Adjustment** (fig. 40.) One packing nut is attached to each end of pump to provide for leakage adjustment. Turn nut at either end

4- TO 5-TON 4x4 TRACTOR TRUCK (AUTOCAR MODEL U-71447)

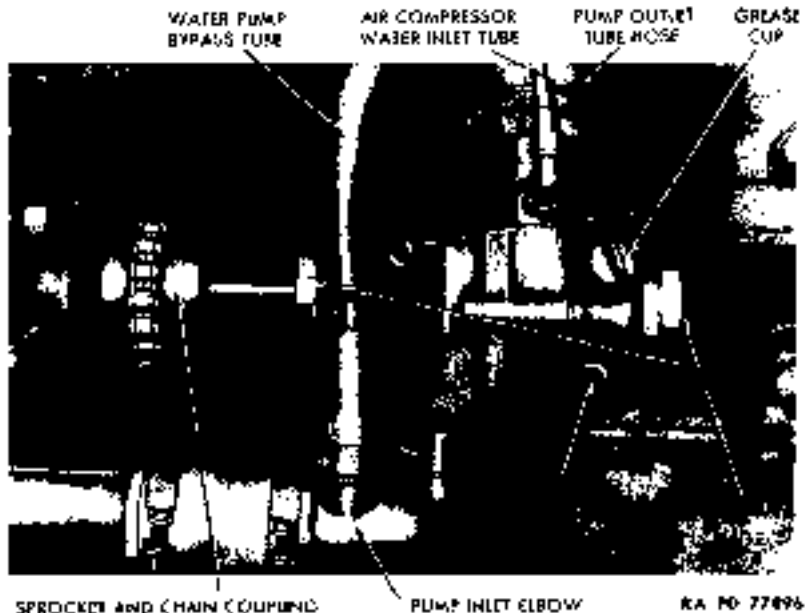

Figure 40 - Water Pump installed

$\frac{1}{4}$ to $\frac{1}{2}$ turn to stop leaks. Front nut tightens counterclockwise, rear nut clockwise. If tightening nuts fail to stop leaks, notify higher authority.

c. Removal.

(1) **DISENGAGE PUMP OUTLET TUBE** (fig. 40). Loosen hose clamp which secures hose to pump, and work hose from pump.

(2) **DISCONNECT PUMP INLET ELBOW** (fig. 40). Remove the two cap screws and lock washers which secure elbow to pump, remove elbow gasket, and pull elbow free from pump.

(3) **DISCONNECT AIR COMPRESSOR WATER INLET TUBE** (fig. 40). Screw tube nut from fitting on pump.

(4) **REMOVE PUMP COUPLING CHAIN** (fig. 40). Drive connecting link lock on front of chain from connecting link, remove link cover, and pry link from chain. Remove chain.

(5) **REMOVE PUMP FROM ENGINE** (fig. 40). Remove the four cap screws and lock washers which secure pump to block. Remove pump, then remove gasket.

d. Installation.

(1) **INSTALL PUMP ON ENGINE** (fig. 40). Install new gasket, and use dowel guide to position pump on engine. Install the four cap screws and lock washers which secure pump to cylinder block.

COOLING SYSTEM

(2) **INSTALL PUMP COUPLING CHAIN** (fig. 40). Position chain to pump coupling sprocket. Insert connecting link, secure with lock, and install cover on link.

(3) **CONNECT PUMP INLET ELBOW** (fig. 40). Using new gasket, position elbow to pump, and secure with the two cap screws and lock washers.

(4) **CONNECT PUMP OUTLET TUBE** (fig. 40). Fit hose over tube, and tighten hose clamp.

(5) **CONNECT AIR COMPRESSOR WATER INLET TUBE** (fig. 40). Screw tube nut to fitting on pump and tighten nut.

75. HOSE CONNECTIONS.

a. Description and Tabulated Data.

(1) **DESCRIPTION** (figs. 11 and 40). Connections consist chiefly of several lengths of straight pipes, elbows, and hose of different diameters and lengths with metal clamps to secure connections.

(2) TABULATED DATA.

Hose:	Number	Diameter	Length
Water outlet	1	1 3/4 in.	9 1/2 in.
Radiator outlet	2	1 3/4 in.	4 in.
Bypass pipe hose	2	1 in.	3 in.
Water pipe discharge hose	1	1 3/4 in.	5 1/2 in.

b. **Removal** (figs. 11 and 40). Disengage connections secured by clamps as follows: Loosen clamp screw, slide clamp away from hose end, and work hose free. Remove cap screws and lock washers to disengage other connections.

c. **Installation** (figs. 11 and 40). Install hose secured by clamps as follows: Join by working end of hose over pipes. Move clamp into position, and tighten clamp screw. Install other connections as follows: Using new gasket, join parts to be connected to each other, and install cap screws and lock washers.

76. THERMOSTAT.

a. Description and Tabulated Data.

(1) **DESCRIPTION** (fig. 41). The thermostat is mounted in the front of water outlet manifold at top of cylinder heads. It is an automatic type valve and controls the circulation of coolant to keep temperature of cooling fluid in engine between 157° F. and 183° F.

(2) TABULATED DATA.

Manufacturer	Bishop and Babcock
Model	3710-B
Opens	183° F.
Closes	157° F.

4. TO 5-TON 4x4 TRACTOR TRUCK (AUTOCAR MODEL U-7144T)

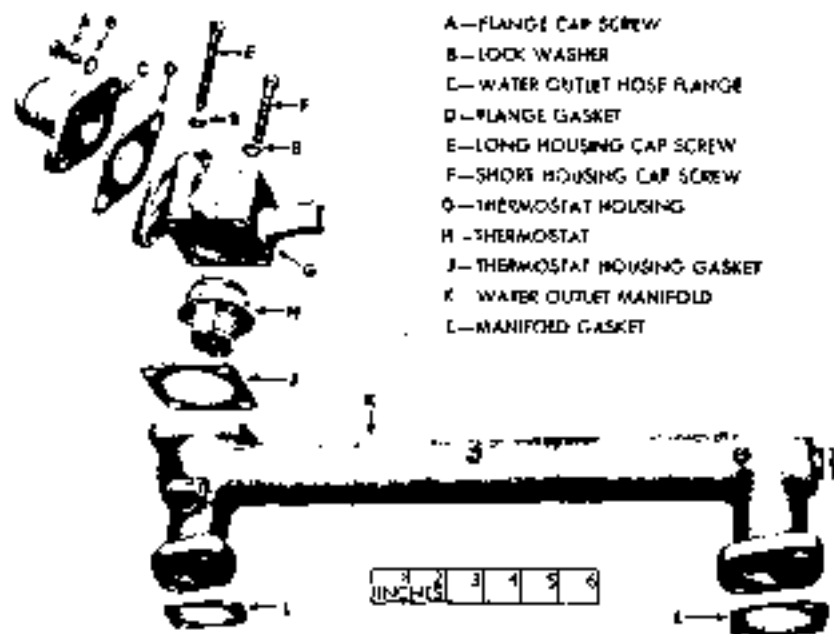

- A—FLANGE CAP SCREW
- B—LOCK WASHER
- C—WATER OUTLET HOSE FLANGE
- D—FLANGE GASKET
- E—LONG HOUSING CAP SCREW
- F—SHORT HOUSING CAP SCREW
- Q—THERMOSTAT HOUSING
- H—THERMOSTAT
- J—THERMOSTAT HOUSING GASKET
- K—WATER OUTLET MANIFOLD
- L—MANIFOLD GASKET

Figure 41 — Thermostat and Related Components RA PD 77912

h. Maintenance (fig. 41). If thermostat does not function properly, place it in a container filled with water. Place thermometer or other satisfactory heat gaging device in water, and heat the water. Thermostat should open. If thermostat does not begin to open within 5° F. of 157° F. and is not fully open within 5° F. of 183° F., replace it.

c. Removal.

(1) DISCONNECT BYPASS TUBE FROM THERMOSTAT HOUSING (fig. 41).

(2) DISCONNECT WATER OUTLET HOSE FLANGE FROM THERMOSTAT HOUSING (fig. 41). Remove the two flange cap screws and lock washers. Lift flange and gasket from housing.

(3) DISCONNECT THERMOSTAT HOUSING FROM WATER OUTLET MANIFOLD (fig. 41). Remove the four cap screws and lock washers which secure thermostat housing to manifold. Remove thermostat housing, gasket, and thermostat.

d. Installation.

(1) INSTALL THERMOSTAT AND HOUSING (fig. 41). Place thermostat in position with bellows down on water outlet manifold. Use new gasket, and position housing on water outlet manifold. Secure with the four lock washers and cap screws.

COOLING SYSTEM

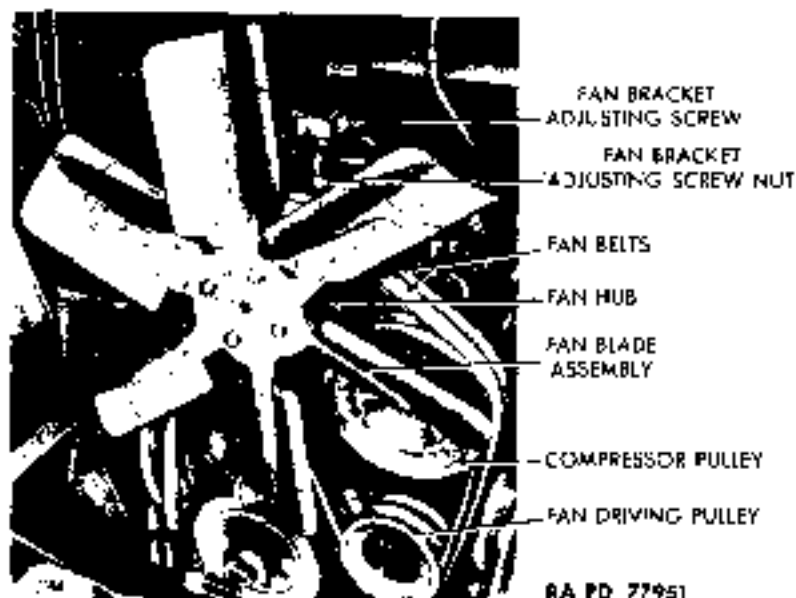

Figure 42 -- Fan and Belts Installed

(2) CONNECT WATER OUTLET HOSE FLANGE TO THERMOSTAT HOUSING (fig. 41). Position flange gasket and flange on housing. Install the two lock washers and cap screws.

(3) CONNECT BYPASS TUBE TO THERMOSTAT HOUSING (fig. 41).

77. FAN.

a. Description and Tabulated Data.

(1) DESCRIPTION (fig. 42). The fan is the roller-bearing type mounted on a bracket at front of engine and belt driven by a pulley on the engine accessory shaft.

(2) TABULATED DATA.

Manufacturer	Schwitzer-Cummins
Model	A-117545
Number of blades	6
Drive	Double V-belts

b. Removal.

(1) REMOVE ENGINE HOOD ASSEMBLY (fig. 19). Loosen the two engine hood catch hooks on right side of engine hood assembly. Remove three screws that secure left side of hood to floor, and lift hood assembly out.

4. TO 3-TON 4 x 4 TRACTOR TRUCK (AUTOCAR MODEL U-7144T)

(2) REMOVE RIGHT AND LEFT TOEBOARDS (par. 56). Remove screws holding right and left toeboards, and lift toeboards out.

(3) REMOVE HEAT INDICATOR CABLE (fig. 13). Unscrew nut from lower right bolt on gearshift instruction plate, and remove clip holding heat indicator cable. Remove left bolt that secures top of engine fan cover assembly to dash. Reach through fan cover to loosen nut, flat washer, lock washer, and clip that secures heat indicator cable.

(4) REMOVE ENGINE FAN COVER ASSEMBLY. Remove five remaining bolts (with one lock washer, two flat washers, and one nut on each) that secure engine fan cover assembly to dash, and lift assembly out.

(5) REMOVE FAN BLADE ASSEMBLY (fig. 42). Remove four cap screws that secure fan blade assembly to fan hub. Lower fan blades through space between radiator and motor. Take off gasket.

(6) REMOVE FAN HUB AND PULLEY. Loosen fan bracket clamp nut. Loosen fan adjusting screw lock nut. Turn fan adjusting screw to lower hub and pulley. Lift fan belts from pulley. Remove three hex cap screws and one slotted countersunk screw securing fan bracket to engine. Lift out fan hub and bracket.

r. Installation.

(1) INSTALL FAN HUB AND PULLEY (fig. 42). Install fan hub and pulley by fastening bracket to engine with three hex screws and one slotted countersunk screw. Install fan belts.

(2) INSTALL FAN BLADE ASSEMBLY (fig. 42). Install fan blade assembly, using a new gasket, and secure assembly to hub with four hex screws. Turn fan adjusting screw to tighten fan belts until they have $\frac{1}{2}$ -inch play. Tighten fan adjusting screw lock nut. Tighten fan bracket clamp nut.

(3) INSTALL ENGINE FAN COVER ASSEMBLY. Place engine fan cover assembly in position, and secure to dash with five bolts (two flat washers, one lock washer and one nut on each). Leave out top left-hand bolt.

(4) FASTEN HEAT INDICATOR CABLE (fig. 13). Install top left-hand nut securing engine fan cover assembly to dash, inserting heat indicator cable clamp between the second flat washer and the lock washer. Place cable in clamp, and tighten nut. Secure cable to top of engine and fan cover assembly, using lower right bolt on name plate and cable clip.

(5) INSTALL RIGHT AND LEFT TOEBOARDS (par. 57). Install right- and left-hand toeboards, and secure with screws.

(6) INSTALL ENGINE HOOD ASSEMBLY. Install engine hood assembly, and secure to floor on the left side with three screws. Fasten on right side with engine hood catch hooks.

IGNITION SYSTEM

78. FAN BELTS.

a. Description and Tabulated Data.

(1) **DESCRIPTION** (fig. 42). Two V-type fan belts are mounted on grooved pulleys connected to fan, air compressor, and accessory drive shaft, and drive the fan and air compressor. Belts are rubber and fabric composition.

(2) TABULATED DATA.

Manufacturer	Hercules
Model	77280B
Deflection permissible	1/2 to 3/4 in.

b. **Adjustment** (fig. 42). Loosen fan bracket adjusting screw nut and fan spindle jam nut. Turn fan bracket adjusting screw clockwise to tighten, counterclockwise to loosen. Deflection permissible is between 1/2 inch and 3/4 inch. After adjustment is made, tighten bracket adjusting screw nut and spindle jam nut.

c. **Removal** (fig. 42). Loosen bracket adjusting screw nut and spindle jam nut, and turn adjusting screw to force spindle down. Lift belts from pulleys.

d. **Installation** (fig. 42). Position belts on pulleys. Turn adjusting screw until belts can be flexed from 1/2 inch to 3/4 inch at mid-position when pressed with fingers. Tighten adjusting screw nut and spindle jam nut.

Section XIX

IGNITION SYSTEM

79. DESCRIPTION (fig. 43).

a. This truck uses a distributor and coil 6-volt ignition system consisting of ignition coil, condenser, distributor, spark plugs, ignition switch, and high and low tension wiring.

80. IGNITION COIL.

a. Description and Tabulated Data.

(1) **DESCRIPTION** (fig. 44). An induction type coil is used to increase voltage for ignition purposes by use of secondary and primary windings on an iron core. The amperage is cut down in a ratio corresponding with the voltage increase. The coil is attached to the water pump discharge manifold on the left side of the engine adjacent to the front cylinder head, and is accessible through the floor board inset opening.

4- TO 5-TON 4 x 4 TRACTOR TRUCK (AUTOCAR MODEL U.7144T)

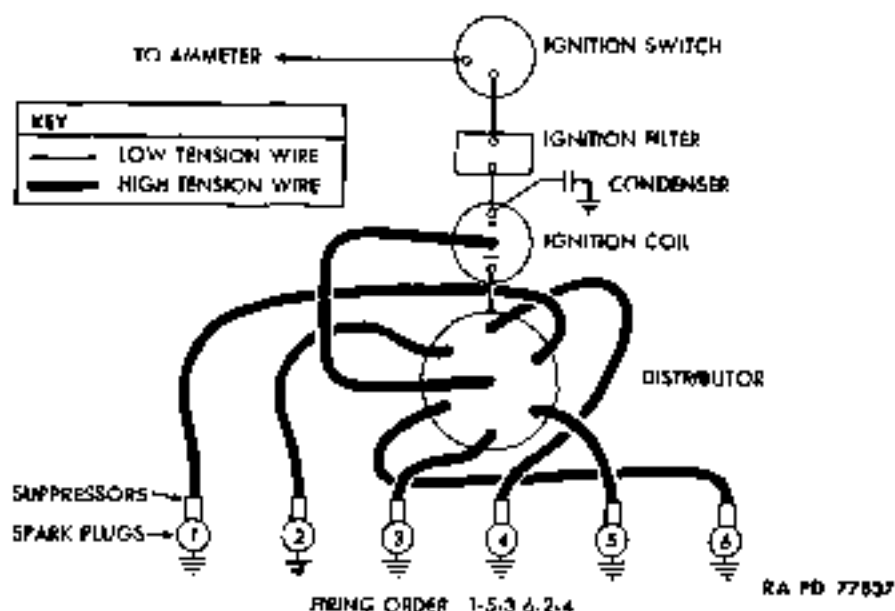

Figure 43 - Ignition System Wiring Diagram

(2) TABULATED DATA.

Manufacturer Auto-Lite
Model IG-4070-H
Size 6-volt

b. Removal.

(1) REMOVE FLOOR BOARD INSERT (fig. 19). Loosen the two wing screws with clamp insert in position, and lift insert from floor board.

(2) DISCONNECT WIRES (fig. 44). Pull secondary lead from tower on top of coil. Remove both nuts and lock washers from low tension terminals on top of coil, and lift the three wires from the two terminals. NOTE: Tag wires to aid in assembly.

(3) REMOVE COIL FROM WATER PUMP DISCHARGE MANIFOLD (fig. 44). Remove the two cap screws and lock washers which hold coil to manifold, and lift coil and condenser from manifold.

c. Installation.

(1) MOUNT COIL ON ENGINE (fig. 44). Place coil and condenser in position on water pump discharge manifold, and install the two lock washers and cap screws which attach coil and condenser to manifold.

(2) CONNECT WIRES (fig. 44). Place low tension wire from distributor on the coil terminal marked "+." Place low tension wire from

IGNITION SYSTEM

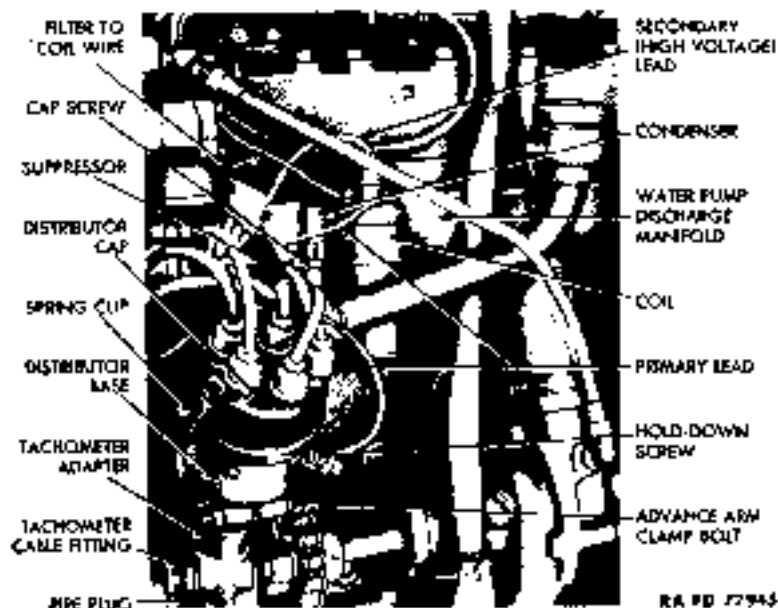

Figure 44 — Distributor and Ignition Coil Installed

ignition filter and wire from condenser on the coil terminal marked "—" Install both lock washers and nuts on coil terminals, and plug high tension wire from center tower of distributor cap into tower on top of coil.

(3) **TEST OPERATION.** Start engine, and check ignition operation.

(4) **INSTALL FLOOR BOARD INSERT** (fig. 19). Position insert on floor board, and tighten the two wing screws which clamp insert to floor board.

81. CONDENSER.

a. Description and Tabulated Data.

(1) **DESCRIPTION** (fig. 46). The automotive type distributor condenser is located on the distributor breaker plate, and can be reached through the splash shield opening under the left fender. The function of the condenser is to intensify the ignition spark.

(2) **TABULATED DATA.**

Manufacturer	Auto-Lite
Model	JGW-3139

b. Removal.

(1) **REMOVE SPLASH SHIELD** (fig. 95). Loosen the four wing screws, lock washers, and flat washers which attach shield to under side of left front fender, and pull shield from fender.



RA PD 77400

Figure 45 - Flywheel Timing Mark

(2) REMOVE DISTRIBUTOR CAP (fig. 44). Unsnap both spring clips, and lift cap from distributor.

(3) REMOVE CONDENSER FROM BREAKER PLATE (fig. 46). Remove screw and lock washer which attach condenser pig tail to breaker arm spring clip. Remove screw and lock washer which attach condenser to breaker plate, and lift condenser from distributor.

c. Installation.

(1) INSTALL CONDENSER IN DISTRIBUTOR (fig. 46). Position condenser on distributor breaker plate. Install lock washer and screw which attach condenser to breaker plate. Connect condenser screw to breaker arm spring clip with lock washer and screw provided for the purpose. Place distributor cap in position on distributor, and engage both spring clips.

(2) TEST INSTALLATION. Start engine, and test operation.

(3) INSTALL SPLASH SHIELD (fig. 95). Place splash shield in position under left front fender. Install the four flat washers, lock washers, and wing screws which secure shield to fender. Install shield to frame bond strap, if removed.

82. DISTRIBUTOR.

a. Description and Tabulated Data.

(1) DESCRIPTION (fig. 44). The distributor is mounted on left side of engine toward the front, and is accessible through left-hand splash shield opening. Its major components are base, drive shaft and

IGNITION SYSTEM

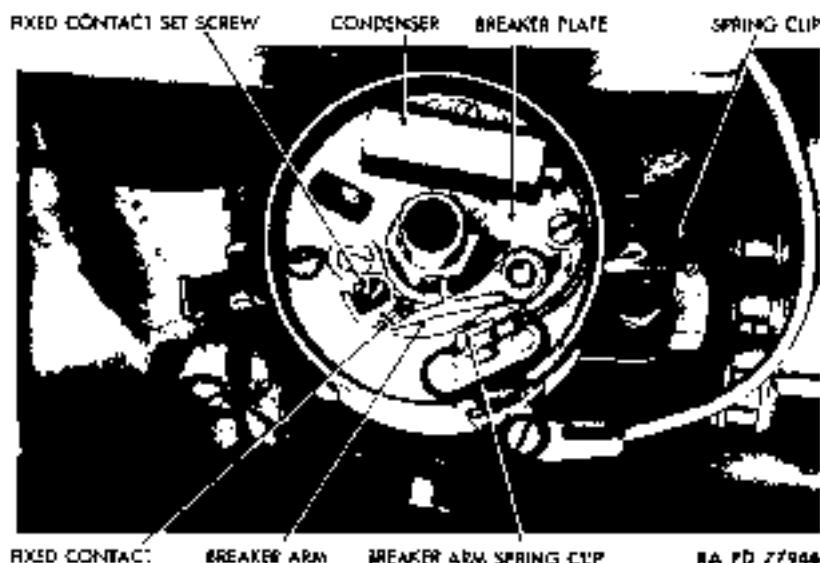

Figure 46 - Distributor With Cap and Rotor Removed

governor, cam, breaker plate, cap, and rotor, and it is driven from the accessory shaft. The function of the distributor is to distribute high tension voltage to spark plugs at timed intervals.

(2) TABULATED DATA.

Manufacturer	Auto-Lite
Model	IGC-4701-1
Type	Full automatic
Point gap	0.020 in.
Breaker arm spring tension	17 to 20 oz

h. Maintenance and Adjustment.

(1) SET IGNITION TIMING (figs. 44 and 46). Remove No. 1 spark plug and turn the engine over by hand until No. 1 piston comes up on the compression stroke. Continue to turn the engine slowly until the "DC" line on the flywheel registers with the timing line on the flywheel housing. Make sure the distributor points are clean, free of pits, and make good contact when closed. Using a dial indicator or wire feeler gage, adjust the points to 0.020-inch gap. Loosen cap screw and clamp bolt on the distributor advance arm. Move the pointer on the advance arm to the center of the scale, and lock in this position with screw. With the engine still on dead center, rotate the distributor in a counterclockwise direction until the points just break. Use a test light in checking this setting. Lock the clamp bolt after the setting is complete. See that the rotor brush is in position. Replace the

4- TO 5-TON 4 x 4 TRACTOR TRUCK (AUTOCAR MODEL U-7144T)

distributor cap, and check the ignition wires. Starting with No. 1 wire and following around the distributor in a clockwise direction, the firing order is 1-5-3-6-2-4. To check the ignition setting, make a chalk mark over the "DC" line on the flywheel as well as over the timing line on the flywheel housing. Replace No. 1 spark plug, and connect a neon timing light to this plug. Start the engine and set at an idling speed of 350 to 400 revolutions per minute, holding the neon light in line with the timing hole in the flywheel housing. If the ignition timing is correct, the chalk mark on the flywheel will be in line with the chalk mark on the housing. If the two marks do not line up, loosen the clamp bolt and advance or retard the distributor as required. Tighten clamp when finished. For the final setting of the distributor, loosen the cap screw on the advance arm, and move the pointer three scale divisions, in a counterclockwise direction (toward the cylinder block), and lock in this position. This gives an ignition timing of 6 degrees before dead center, which is correct.

(2) **CHECK AND ADJUST BREAKER POINT GAP** (fig. 46). Unsnap both spring clips, and lift cap and rotor from distributor. Rotate engine with hand crank until points are opened to widest gap, and measure gap. Correct measurement of gap is 0.020 inch. If it deviates by more than 0.002 inch from 0.020 inch, loosen fixed contact set screw, and move fixed contact until gap measures 0.020 inch. Tighten set screw, check breaker arm spring tension, and adjust if necessary (step (3) below). Install rotor and distributor cap.

(3) **CHECK AND ADJUST BREAKER ARM SPRING TENSION** (fig. 46). Hook a scale spring on breaker arm at contact, and hold scale at right angles to surfaces of contacts. Pull contacts apart, and observe scale reading. If not within the limits of 17 to 20 ounces, loosen screw which anchors breaker arm spring clip, and slide spring out or in to decrease or increase tension. Tighten screw and again check tension, repeating process until test shows 17 to 20 ounces of tension.

(4) **REPLACE BREAKER POINTS** (fig. 46). Unsnap spring clips, and lift cap and rotor from distributor. Remove breaker arm and condenser wire screw, and lift breaker arm from pivot. Remove fixed contact set screw, and lift out contact plate. Place new contact plate in position, and install fixed contact set screw fingertight. Place breaker arm in position on pivot. Install breaker arm and condenser wire screw. Adjust breaker arm spring tension, and adjust breaker point gap. Install rotor and distributor cap.

c. Removal.

(1) **REMOVE SPLASH SHIELD** (fig. 95). Remove the four wing screws, lock washers, and flat washers which secure shield to fender, and pull shield from fender.

IGNITION SYSTEM

(2) **DISCONNECT WIRES** (fig. 44). Unsnap both spring clips, and lift distributor cap from distributor. Leave high tension wires attached to cap, and disconnect low tension primary lead wire from terminal on side of distributor.

(3) **DETACH DISTRIBUTOR** (fig. 44). Loosen advance arm clamp bolt. Remove hold-down screw, and lift distributor from tachometer adapter.

d. Installation.

(1) **ATTACH DISTRIBUTOR TO TACHOMETER DRIVE** (fig. 44). Insert base of distributor into its boss in tachometer drive, and install hold-down screw.

(2) **TIME IGNITION** (subpar. b (1), above).

(3) **CONNECT WIRES** (fig. 44). Connect low tension primary wire to terminal on side of distributor, and install cap with attached wires on distributor.

(4) **TEST INSTALLATION**. Start engine, and check operation.

(5) **INSTALL SPLASH SHIELD** (fig. 95). Place shield in position under left front fender, and install the four flat washers, lock washers, and wing screws which secure shield to fender. Install shield to frame bond strap if removed.

83. SPARK PLUGS.

a. Description and Tabulated Data.

(1) **DESCRIPTION** (fig. 13). Each cylinder is equipped with a one-piece spark plug containing an insulated pair of electrodes. An electric spark jumps across the arc to fire the fuel charge in the cylinder. Spark plugs project from the top of the cylinder heads, and can be reached by lifting right-hand side of engine hood.

(2) TABULATED DATA.

Manufacturer	Champion
Type	J-10
Size	14-mm
Gap setting	0.025 in.

b. **Removal** (fig. 13). Loosen the two spring catches, and open right-hand side of engine hood inside cab. Pull spark plug wires straight up to remove from plugs, and unscrew spark plugs from cylinder heads. Lift gaskets from spark plugs or cylinder heads.

c. Maintenance and Adjustment.

(1) **INSPECT SPARK PLUGS**. Note condition of electrodes, and replace plug if electrodes are burned. Examine porcelain, and replace plug if porcelain is cracked or broken. Note color of porcelain tip adjacent to electrode; light brown color indicates plug is oper-

4- TO 5-TON 4 x 4 TRACTOR TRUCK (AUTOCAR MODEL U-7144T)

ating normally, dead white color indicates need of a colder type plug, glossy black color indicates piston is allowing oil to pass, and a dull black deposit indicates carburetor is out of adjustment. If color indicating defective plug is found, correct, service, or replace.

(2) **CLEAN, ADJUST, AND TEST SPARK PLUGS.** Clean spark plugs with a plug cleaner every 6,000 miles. Adjust gap to 0.025 inch, using a round-type (not flat) feeler gage and bending only outside electrode to make adjustment. Test cleaned and adjusted spark plug under 105 pounds of air pressure. If spark fails to flow freely, replace plug.

d. **Installation (fig. 13).** Place gasket on each spark plug, and screw plugs into their openings in tops of cylinder heads. Push spark plug wires down onto spark plug terminals. Close engine hood, and engage spring catches.

84. IGNITION SWITCH.**a. Description and Tabulated Data.**

(1) **DESCRIPTION (fig. 3).** The key-type ignition switch is located near the lower center of the instrument panel. Removal of the key is possible only when switch is off. Two terminals are located on back of switch; battery wire from the ammeter connects to one terminal, and two distribution wires connect to the other terminal. One distribution wire goes to the ignition filter enroute to the ignition coil, while the other wire leads to a 30-ampere circuit breaker, and thence to the fuel gage and air pressure warning buzzer.

(2) TABULATED DATA.

Manufacturer	Delco-Remy
Model	1997756
Type	Key

b. **Removal (fig. 3).** Disconnect all three wires from the two terminals on rear of switch, and screw switch retaining nut from face of instrument panel. Pull switch from reverse side of panel.

c. **Installation (fig. 3).** Insert switch, key-end first, through its opening from reverse side of instrument panel. Turn switch so smooth edge of key is down when inserted into switch, and install retaining nut. Connect leads from ignition filter and circuit breaker to right-hand terminal on back of switch. Connect battery wire from ammeter battery post to left-hand switch terminal. Start engine, and check operation.

85. WIRING.

a. **Description (fig. 43).** High tension wires are used to conduct high-voltage current from ignition coil to distributor and from dis-

STARTING AND GENERATING SYSTEMS

tributor to spark plugs. The low tension part of the ignition system ties into the wiring harness. Spark plug wires are threaded through eight nipples which guide them from distributor to spark plugs.

b. **Maintenance.** Wipe all dirt from high tension wires having worn or cracked insulation. Inspect tips, and clean with flint paper if corroded.

c. Removal.

(1) **REMOVE SPARK PLUG WIRE** (fig. 43). Loosen both wing screws, and lift floor board insert from floor board. Loosen both spring catches on open right-hand side of engine hood. Pull wire from distributor and spark plug, then pull wire from nipples which hold it in position between distributor and spark plug.

d. Installation.

(1) **INSTALL SPARK PLUG WIRE** (fig. 43). Thread wire through nipples which hold wire in position between distributor and spark plug. Push ends of wire onto spark plug and into tower of distributor cap, respectively. Close engine hood and engage both spring catches. Install floor board insert, and tighten both wing screws.

Section XX

STARTING AND GENERATING SYSTEMS

86. DESCRIPTION (fig. 47).

a. The starting system consists of a 12-volt cranking motor and a switch-operated solenoid, operating on two 6-volt batteries. A special design series-parallel cranking motor switch connects the batteries in series to operate the cranking motor. The rest of the electrical system operates on 6 volts with the batteries connected in parallel.

b. The generating system consists of a 6-volt generator and a separate voltage and current regulator. Since the batteries are connected in parallel except during cranking motor operation, the generator delivers its output to both batteries at the same time.

87. GENERATOR.

a. Description and Tabulated Data.

(1) **DESCRIPTION** (fig. 48). The heavy-duty two-brush type 6-volt generator is located at the right front of the engine between engine and frame side rail. It is accessible through the splash shield opening under the right front fender, and is gear driven from the engine gear case. The generator furnishes electrical energy to keep batteries charged, and to operate the electrical system.

4- TO 5-TON 4 x 4 TRACTOR TRUCK (AUTOCAR MODEL U-7144T)

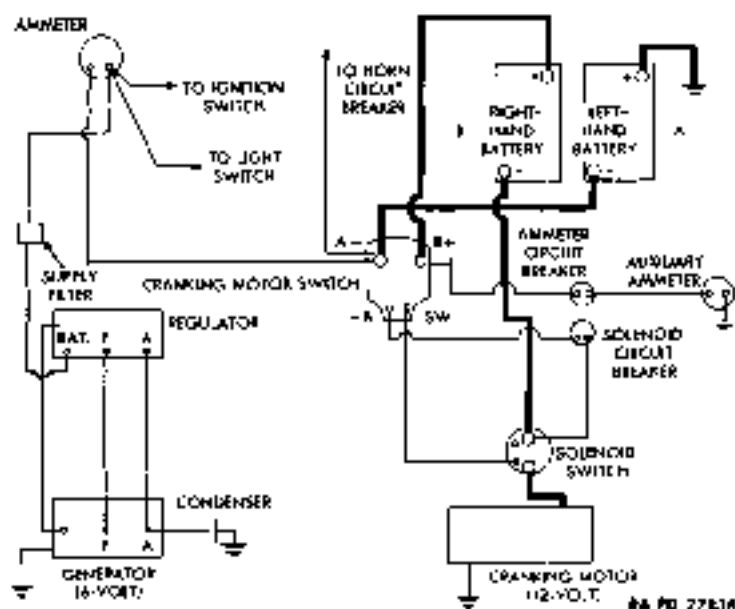

Figure 47 — Wiring Diagram of Starting and Generating Systems

(2) TABULATED DATA.

Manufacturer	Auto-Lite
Model	GEW-4802
Voltage	6

b. Maintenance.

(1) **INSPECT GENERATOR.** Remove generator head band (fig. 48). Note condition of commutator. If dirty or discolored, clean commutator (step (2) below). If commutator is rough, out of round, or if it has high mica, notify higher authority. Hook a spring scale to brush holder lever, pull scale at right angles to holder, and note reading as holder lifts from brush. If not within the limits of 64 to 68 ounces, notify higher authority. Inspect brushes, and if worn to one-half the original length, replace brushes (step (3) below). Check brush lead connections to be sure they are clean and tight. Replace head band.

(2) **CLEAN COMMUTATOR.** Remove head band. Hold a piece of flint paper 2/0 against commutator and crank engine. Blow dust from generator with dry air blast. Replace head band.

(3) **REPLACE BRUSHES.** Remove head band, screw, and lock washer which secures brush lead to brush holder. Lift up on brush holder lever, and pull brush from holder. Raise lever, and insert new brush into position in holder. Connect brush lead to holder with lock washer and screw provided for the purpose; then draw a strip of flint

STARTING AND GENERATING SYSTEMS

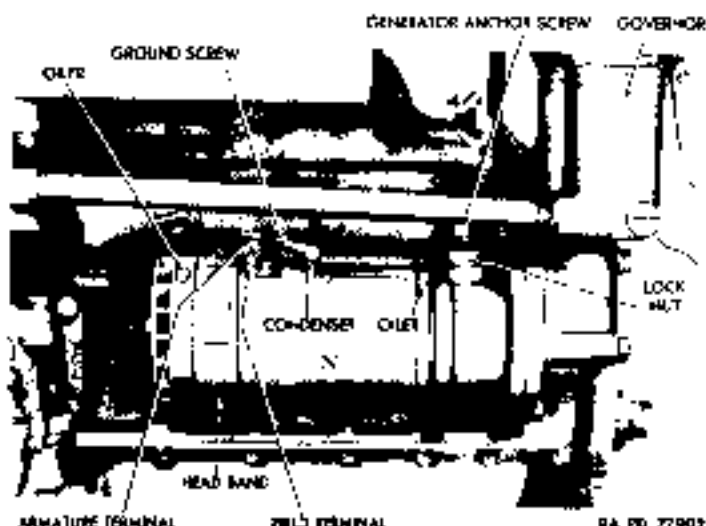

Figure 48 — Generator Installed

paper 2/0, sanded side up, around commutator under brush to correct brush to commutator contact. **CAUTION:** *Avoid excessive sanding. Repeat procedure to install other brush, and install head band.*

c. Removal.

(1) **REMOVE SPLASH SHIELD** (fig. 95). Remove the four wing screws, lock washers, and flat washers which secure splash shield to under side of right front fender, and pull shield from fender.

(2) **DISCONNECT WIRES** (fig. 47). Disconnect the three wires and one hand strap from top of generator. Tag wires to facilitate installation.

(3) **DETACH GENERATOR** (fig. 48). Loosen lock nut and generator anchor screw, and work generator back carefully until gears are out of mesh. Lift generator from engine.

d. Installation.

(1) **CHECK GOVERNOR GEAR.** Inspect governor gear to be certain it is properly mounted and that drilled head cap screws are fastened with lock wire.

(2) **ATTACH GENERATOR TO ENGINE** (fig. 48). Insert generator into engine opening, and carefully work gear into mesh with camshaft and governor gears. Tighten anchor screw and lock nut.

4. TO 5-TON 4 x 4 TRACTOR TRUCK (AUTOCAR MODEL U-71447)

(3) **CONNECT WIRES** (fig. 47). Connect red wire from harness and condenser lead on armature terminal. Connect yellow wire from harness on field terminal. Connect condenser, black wire from harness, and bond strap from frame on ground screw.

(4) **POLARIZE GENERATOR**. Momentarily connect a jumper wire between armature terminals of generator (fig. 48), and voltage regulator (fig. 49), then remove jumper wire.

(5) **TEST OPERATION**. Start engine and observe ammeter. Correct charging rate is 8 amperes at 600 revolutions per minute. If charging rate is less than 8 amperes, loosen third brush holder plate screw, and shift third brush in direction of armature rotation until desired charging rate is obtained. Tighten third brush screw.

(6) **INSTALL SPLASH SHIELD** (fig. 95). Place shield in position under fender, and install the four flat washers, lock washers, and wing screws which hold shield to fender.

88. REGULATOR**a. Description and Tabulated Data.**

(1) **DESCRIPTION** (fig. 49). The generator current and voltage regulator is mounted in driver's compartment on dash under center of instrument panel, and is composed of three units: Circuit breaker, current limiting regulator, and voltage regulator.

(2) TABULATED DATA.

Manufacturer	...	Auto-Lite
Model	...	VRY-4201A
Voltage	...	6
Ground polarity	...	Positive

b. Removal.

(1) **DISCONNECT WIRES** (fig. 49). Disconnect all four wires from regulator terminals. *NOTE. Tag wires to facilitate installation.*

(2) **DETACH REGULATOR FROM DASH** (fig. 49). Remove the two screws, lock washers, and bonding washers which attach top corners of regulator to dash. Have one man work through radiator filler door to keep nuts from turning, while another man removes bolts which attach bottom corners of regulator to dash. Remove lock washers, and lift regulator from dash.

c. Installation.

(1) **ATTACH REGULATOR TO DASH** (fig. 49). Position regulator on dash with terminals down. Install bonding washers between regulator and dash, lock washers, and screws which attach upper corners of regulator to dash. Insert bolts which attach lower corners of unit to dash through regulator and dash. Hold bolts rigid while another

STARTING AND GENERATING SYSTEMS

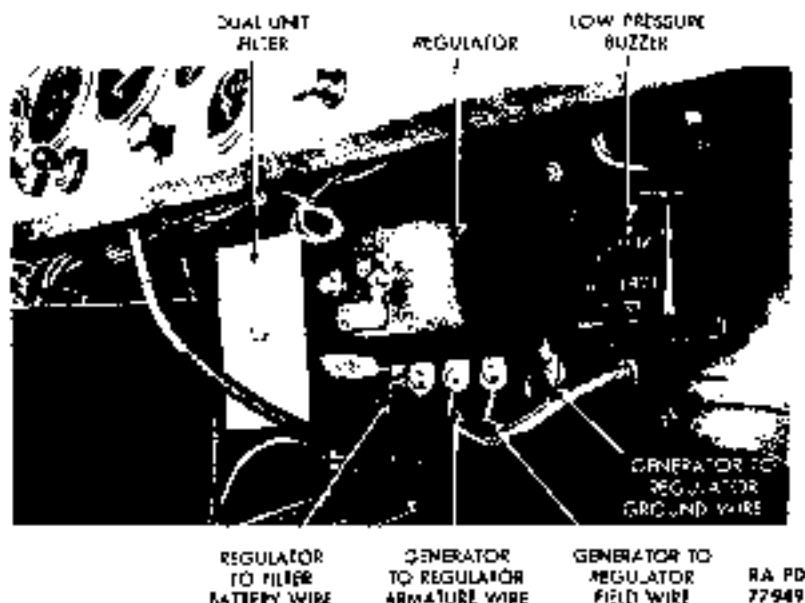

Figure 49 -- Generator Regulator Installed

man, working through radiator filler door, installs lock washers and nuts.

(2) **CONNECT WIRES** (fig. 49). Connect wires to regulator as follows: Blue wire from generator armature terminal to armature terminal, yellow wire from generator field terminal to field terminal, green wire from supply filter to battery terminal, black wire from generator ground screw to ground terminal.

89. CRANKING MOTOR.

a. Description and Tabulated Data.

(1) **DESCRIPTION** (fig. 50). The conventional 12-volt cranking motor is located on the right side of the engine between engine and frame side rail, and is accessible through the right-hand splash shield opening and from under the truck. A cranking motor drive, attached to the end of armature shaft and enclosed in a cast iron housing, engages the flywheel ring gear to crank the engine. Drive housing and cranking motor are secured to each other by the main frame screws.

(2) **TABULATED DATA.**

Manufacturer	Auto-Lite
Model	ML-4209
Type	12-volt

4- TO 5-TON 4x4 TRACTOR TRUCK (AUTOCAR MODEL U-7144T)

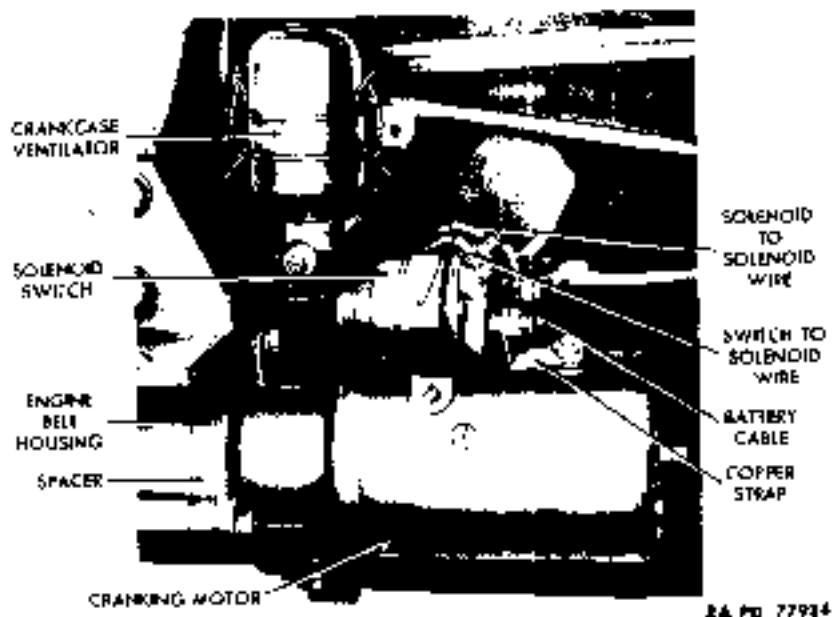

Figure 50 - Cranking Motor and Solenoid Installed

b. Removal.

(1) REMOVE SPLASH SHIELD (fig. 95). Remove the four wing screws, lock washers, and flat washers which attach splash shield to under side of right front fender, and pull shield from fender.

(2) DISCONNECT SOLENOID SWITCH FROM CRANKING MOTOR (fig. 50) (par. 90 b (3)).

(3) DETACH CRANKING MOTOR FROM ENGINE (fig. 50). Remove the three cap screws and lock washers which attach cranking motor to engine bell housing. Two screws can be reached through splash shield opening and one from under truck. Lift cranking motor and spacer from engine and from under truck.

c. Installation.

(1) ATTACH CRANKING MOTOR TO ENGINE (fig. 50). From under truck, place spacer and cranking motor in position on engine bell housing. Install three cap screws and lock washers which secure motor to engine.

(2) CONNECT SOLENOID SWITCH TO CRANKING MOTOR (fig. 50) (par. 90 a (1)).

(3) TEST INSTALLATION. Push cranking switch, and check cranking motor operation.

(4) INSTALL SPLASH SHIELD (fig. 95). Position shield on opening

STARTING AND GENERATING SYSTEMS

under fender. Install the four flat washers, lock washers, and wing screws which attach shield to fender. Install shield to frame bond strap, if removed.

90. SOLENOID SWITCH.

a. Description and Tabulated Data.

(1) **DESCRIPTION** (fig. 50). This solenoid switch is located directly on top of cranking motor, and can be reached by removing right-hand floor board. This switch, which provides a direct battery to cranking motor circuit, is similar to the conventional type relay or magnetic switch. When cranking motor switch is depressed, a coil within solenoid switch is energized. This coil produces a magnetic field which closes the solenoid's magnetic contacts. The contacts are heavy-duty high arc resisting, to withstand heavy current load.

(2) TABULATED DATA.

Manufacturer	Delco-Remy
Model	XA569
Type	Automatic
Capacity	12-volt

b. Removal.

(1) **REMOVE RIGHT-HAND FLOOR BOARD** (fig. 19). Remove the six screws and lock washers which attach right-hand floor board to cab. Lift floor board from cab.

(2) **DISCONNECT WIRES FROM SWITCH** (fig. 50). Disconnect small red wire coming from harness, from switch top right terminal. Disconnect large red wire from harness and small red wire coming from switch front left terminal, from switch top left terminal. Remove battery cable and small red wire which goes to switch top left terminal, from switch front left terminal. Disconnect flat copper strap which goes to cranking motor terminal from switch front right terminal.

(3) **DETACH SWITCH FROM CRANKING MOTOR** (fig. 50). Remove the two screws and lock washers which secure switch to cranking motor, and lift switch from motor.

c. Installation.

(1) **ATTACH SWITCH TO CRANKING MOTOR** (fig. 50). Position switch on cranking motor, and install the two lock washers and screws.

(2) **CONNECT WIRES** (fig. 50). On switch front right terminal, install flat copper strap from cranking motor terminal, lock washers, and nut. On switch front left terminal, install battery cable, small red wire which goes to switch top left terminal, lock washer, and nut. On switch top left terminal, install large red wire from harness and small red wire from switch front left terminal, lock washer, and nut. On

4. TO 5-TON 4 x 4 TRACTOR TRUCK (AUTOCAR MODEL U-7144T)

switch top right terminal, install small red wire from harness, lock washer, and nut.

(3) **TEST INSTALLATION.** Depress cranking motor switch, and test operation.

(4) **INSTALL FLOOR BOARD** (fig. 19). Position right-hand floor board, and install the six lock washers and screws which attach it to cab.

91. CRANKING MOTOR SWITCH.

a. Description and Tabulated Data.

(1) **DESCRIPTION** (fig. 51). The cranking motor switch is located on a bracket immediately below left-hand floor board, with push button extending through a hole in the floor board into the driver's compartment. The main body of switch can be reached by removing left-hand floor board. This manually operated switch is the series-parallel type. When depressed, it connects the batteries in series for 12-volt cranking motor operation; when released, it connects them in parallel for 6-volt generator operation.

(2) TABULATED DATA.

Manufacturer	Auto-Lite
Model	XA-570
Type	Series parallel

b. Removal.

(1) **REMOVE LEFT-HAND FLOOR BOARD** (fig. 19). Remove the seven screws and lock washers which attach floor board to cab and switch bracket, and lift floor board from cab.

(2) **DISCONNECT WIRES** (fig. 51). Disconnect all seven wires from switch. *NOTE: Tag wires to facilitate installation.*

(3) **DETACH SWITCH FROM BRACKET** (fig. 51). Remove the two cap screws and lock washers which secure switch to bracket, and lift switch from bracket.

c. Installation.

(1) **ATTACH SWITCH TO BRACKET** (fig. 51). Place switch in position on bracket, and install both lock washers and cap screws which secure switch to bracket.

(2) **CONNECT WIRES TO SWITCH** (fig. 51). On terminal marked "B-" install red wire from solenoid switch circuit breaker (adjacent to switch on switch bracket). Install lock washer and nut. On terminal marked "SW," install red wire from harness, lock washer, and nut. On terminal extending from right side of switch, install green wire from auxiliary ammeter circuit breaker, lock washer, and nut. On terminal marked "B+," install battery cable from positive post of right-hand

STARTING AND GENERATING SYSTEMS

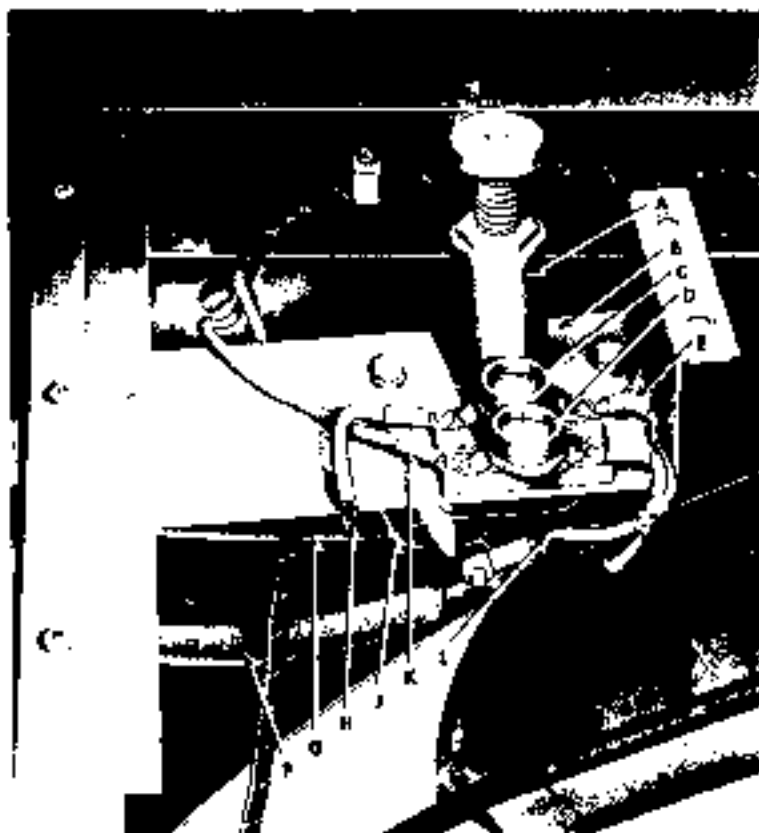

RA PD 37932

- A—SWITCH
- B—BRACKET
- C—SOLENOID SWITCH CIRCUIT BREAKER
- D—AUXILIARY AMMETER CIRCUIT BREAKER
- E—SWITCH TO SOLENOID CIRCUIT BREAKER WIRE
- F—BATTERY CABLE (FROM NEGATIVE POST OF L.H. BATTERY)
- G—BATTERY CABLE (FROM POSITIVE POST OF R.H. BATTERY)
- H—CIRCUIT BREAKER TO SOLENOID WIRE
- J—SWITCH TO AMMETER WIRE
- K—CIRCUIT BREAKER TO AMMETER WIRE
- L—SWITCH TO AMMETER CIRCUIT BREAKER WIRE

Figure 31 — Cranking Motor Switch Installed

4- TO 5-TON 4 x 4 TRACTOR TRUCK (AUTOCAR MODEL U-7144T)

battery, lock washer, and nut. On terminal marked "A-," install battery cable from negative post of left-hand battery, yellow wire with black tracer from harness, and large red wire from harness. Install lock washer and nut.

(3) **TEST INSTALLATION.** Start engine with cranking motor, and test operation.

(4) **INSTALL FLOOR BOARD** (fig. 19). Place floor board in position. Install the seven lock washers and screws which attach floor board to cab and to switch bracket.

92. CABLES.

a. **Description** (fig. 47). Four heavy, high amperage, covered battery cables of different lengths are used. A battery terminal is soldered to one end of each cable and a flat tip to the other. One cable connects the positive post of the left-hand battery to frame, one leads from negative post of left-hand battery to "A-" terminal of cranking motor switch, one connects positive post of right-hand battery to "B +" terminal of cranking motor switch, and one connects negative post of right-hand battery directly to solenoid switch on cranking motor.

b. **Maintenance.** Inspect cables at time of each chassis lubrication, and tighten terminals if necessary. Clean corrosion from connections, and apply a film of grease to connections which show tendency to corrode. If insulation shows signs of wear, install loom, wrap with tape, or replace cable.

c. **Removal** (fig. 47). Remove driver's seat cushion, and lift seat. Disconnect cable from battery. For any cable but battery to solenoid switch, work from under truck, and disconnect other end of cable. For battery to solenoid switch cable, remove right-hand floor board, and disconnect cable from switch on top of cranking motor. From under truck, remove the two cap screws which attach cable clips. Pull cable from vehicle.

d. **Installation** (fig. 47). Work cable in position in vehicle. Connect the two clips which hold cable in position across rear of oil pan on battery to solenoid cable. First, connect end of cable away from battery, then connect cable to battery. Test installation by depressing cranking motor switch. Coat connections at battery with a film of grease. Close driver's seat, and install cushion. Install floor board, if removed.

Section XXI

TRANSMISSION

93. DESCRIPTION AND TABULATED DATA.

a. **Description** (fig. 21). The transmission, which transmits engine power received through the clutch to the propeller shaft connecting the transmission and transfer case, is attached to the clutch bell housing at rear of engine. It has five forward speeds and one reverse. Silent helical gears run in constant mesh in third speed and overdrive, and fourth speed is a direct drive. Gears are selected by a manually operated gearshift lever. A power take-off opening is located on right side, and drive may be taken from a straight tooth gear mounted on the countershaft.

b. **Tabulated Data.**

Manufacturer	Autocar
Oil capacity:	
Summer	7 qt
Winter	9 qt

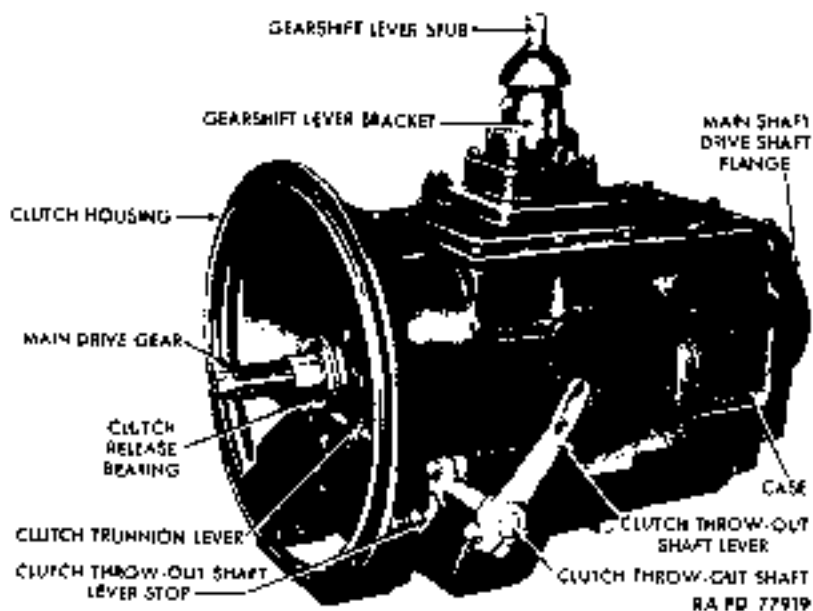

Figure 52 - Transmission

4- TO 5-TON 4x4 TRACTOR TRUCK (AUTOCAR MODEL U-7144T)

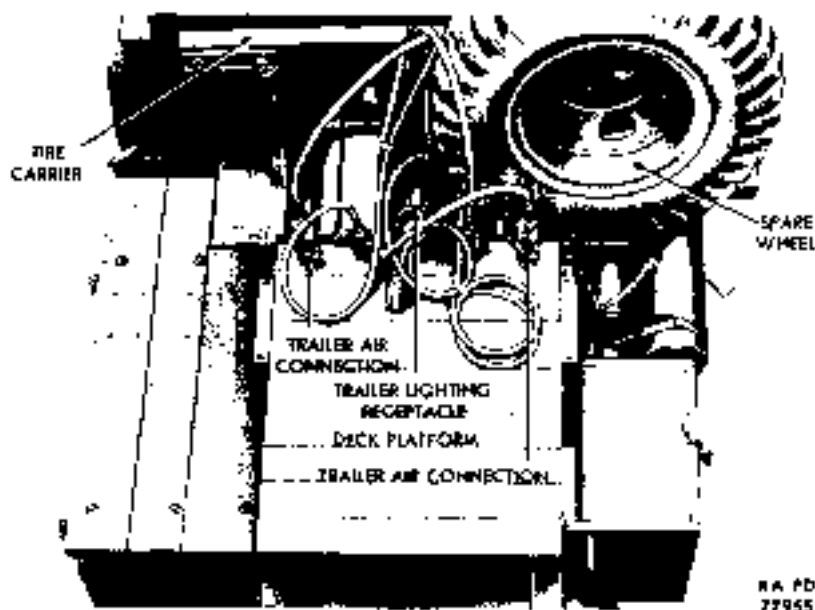

Figure 53 - Trailer Connections and Deck Platform

94. REMOVAL.

a. Remove Spare Wheel (fig. 53). Unlock padlock. Remove the two nuts, lock washers, and clamp bracket which secure wheel to tire carrier assembly, and remove wheel.

b. Remove Trailer Lighting Receptacle and Deck Platform Assembly (fig. 53). Remove the two bolts, nuts, and lock washers which secure trailer lighting cable receptacle bracket to deck platform, and free bracket from deck platform. Detach the two hose couplings, and pull hose free from deck platform. Loosen clamping stud which secures air tubing to semitrailer hose assembly, and pull tube free from assembly. Remove the 12 bolts, nuts, and 24 lock washers which secure frame to deck platform brackets to deck platform. Remove deck platform from vehicle.

c. Remove Intermediate Propeller Shaft (par. 103).

d. Disconnect Bond Strap (fig. 20). Remove cap screw and lock washer which secure strap and transmission to bell housing, and pull strap free.

e. Remove Clutch Release Bearing Oil Tube (fig. 20). Screw out clamp nut which secures tube to transmission. Remove tube nut which joins tube at bracket secured to rear cylinder head at right-hand side, and remove tube.

TRANSMISSION

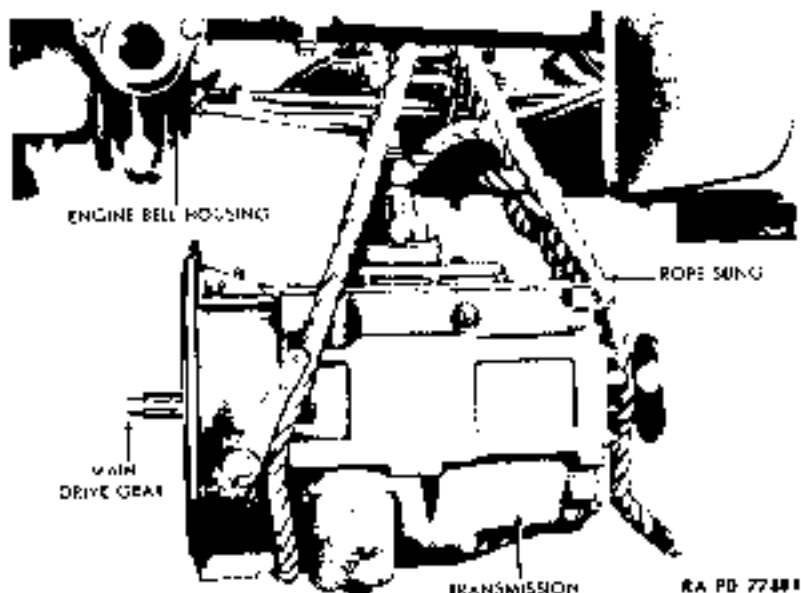

Figure 54 - Removing Transmission

f. **Disconnect Transmission Gearshift Lever (fig. 20).** Loosen the nut and bolt which clamp lever to gearshift lever stub. Pry lever from stub (fig. 52), and remove Woodruff key from stub.

g. **Disconnect Clutch Control Rod From Clutch Throw-out Shaft (fig. 52) (par. 60).**

h. **Disconnect Accelerator Spring Clip.** Remove the cap screw and lock washer which secures spring clip and transmission to bell housing. Remove clip.

i. **Remove Front Propeller Shaft Brake Rod (par. 132).**

j. **Remove Gearshift Control Rod (par. 97).**

k. **Remove Declutch Shift Control Rod (par. 97).**

l. **Disconnect Control Bracket From Transmission (fig. 79).** Remove the two cap screws and lock washers which secure bracket to transmission.

m. **Remove Transmission (fig. 54).** Attach rope sling to transmission. Attach chain fall or other suitable lifting apparatus to sling, and pull up just enough to take weight of transmission from bell housing. Remove remaining eight cap screws and lock washers (two already removed) which secure transmission to bell housing.

4. TO 5-TON 4x4 TRACTOR TRUCK (AUTOCAR MODEL U-7144T)

NOTE: The two bottom cap screws are removed from inside housing. Remove clutch inspection plate to gain access. Pull transmission straight back, or roll vehicle ahead until main drive gear clears clutch. **CAUTION:** Do not permit transmission to drag on clutch. Lower transmission to floor, and slide from under vehicle.

95. INSTALLATION.

a. **Position Transmission to Clutch Bell Housing (fig. 54).** Slide transmission under vehicle. Attach rope sling, and raise to position about a foot behind bell housing with chain fall and rope sling. Push transmission forward to position against bell housing. Install 8 of the 10 cap screws and lock washers which secure transmission to housing. Remove rope sling and lifting apparatus.

b. **Connect Control Bracket (fig. 79).** Install the two cap screws and lock washers which secure bracket to transmission.

c. **Install Declutch Shift Control Rod (par. 97).**

d. **Install Gearshift Control Rod (par. 97).**

e. **Install Front Propeller Shaft Brake Rod (par. 132).**

f. **Connect Accelerator Spring Clip (fig. 21).** Position clip to transmission, and install the cap screw and lock washer which secures clip and transmission to bell housing.

g. **Connect Clutch Control Rod to Clutch Throw-out Shaft Lever (par. 60).**

h. **Install Transmission Gearshift Lever (fig. 20).** Insert Woodruff key at front of lever stub. Position lever over stub, and tap into position. Tighten bolt and nut which secures lever to lever stub.

i. **Install Clutch Release Bearing Oil Tube (fig. 20).** Position tube to transmission and bracket at rear right-hand cylinder head. Tighten tube nut which joins tube together at bracket. Insert and tighten clamp nut which secures tube transmission.

j. **Connect Band Strap (fig. 20).** Position strap to transmission, and install the cap screw and lock washer which secures strap and transmission to bell housing.

k. **Install Intermediate Propeller Shaft (par. 103).**

l. **Install Deck Platform Assembly and Trailer Lighting Receptacle (fig. 53).** Position deck platform to frame. Secure with the 12 bolts, nuts, and 24 lock washers. Position trailer lighting cable receptacle bracket to deck platform, and secure with the 2 bolts, lock washers, and nuts. Tighten clamping stud which secures air tubing

TRANSFER CASE

to semitrailer hose assembly, and attach the two hose couplings to coupling brackets.

m. **Install Spare Wheel** (fig. 53). Position wheel to tire carrier. Secure with the two nuts, lock washers, and clamp bracket.

Section XXII

TRANSFER CASE

96. DESCRIPTION AND TABULATED DATA.

a. **Description** (fig. 20). The transfer case is mounted on vehicle at rear of main transmission. It transfers engine power through propeller shafts from the transmission to the front and rear axles. Gears are arranged for two speeds, one direct which is high range, and the other underdrive which is low range. Speeds are selected through linkage attached to a lever in the cab. The front axle is engaged and disengaged through linkage attached to a declutch lever in the cab. The truck cannot be operated in low range with front axle disengaged.

b. **Tabulated Data.**

Manufacturer	Tamken
Gear ratios:		
High range	1.00—1
Low range	1.72—1

97. LINKAGE.

a. **Removal.**

(1) **DISCONNECT GEARSHIFT CONTROL ROD** (fig. 55). Remove the cotter pin, clevis pin, and flat washer from each end of rod, and remove rod.

(2) **REMOVE DECLUTCH SHIFT CONTROL ROD** (fig. 55). Remove the cotter pin, flat washer, and clevis pin at each end, and remove rod.

(3) **DISCONNECT DECLUTCH SHIFT LEVER** (fig. 55). Remove the cotter pin, flat washer, and clevis pin which secure lever to declutch shift control link.

b. **Installation.**

(1) **CONNECT DECLUTCH SHIFT LEVER** (fig. 55). Position lever to declutch shift control link. Secure with clevis pin, flat washer, and cotter pin.

(2) **CONNECT DECLUTCH SHIFT CONTROL ROD** (fig. 55). Position rod between declutch shift hand lever and declutch shift transfer lever. Secure with the clevis pin, flat washer, and cotter pin at each end.

4- TO 5-TON 4 x 4 TRACTOR TRUCK (AUTOCAR MODEL U-7144T)

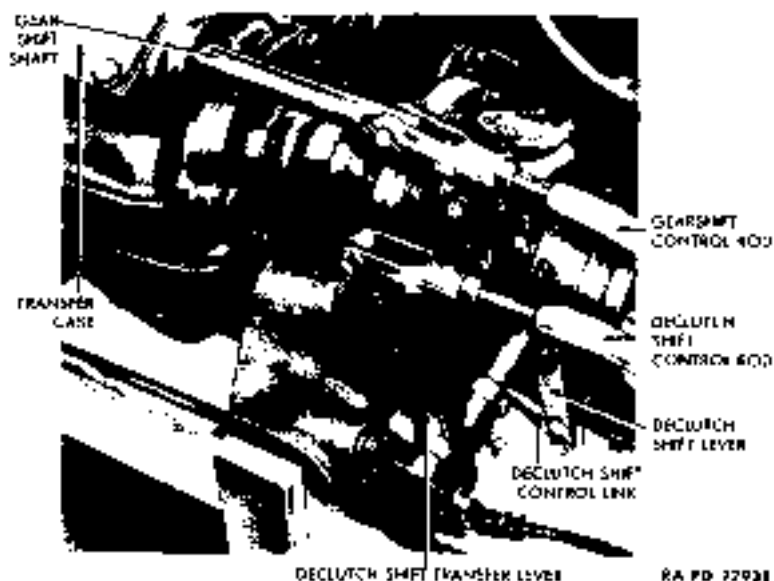

Figure 55 — Transfer Case Linkage

(3) CONNECT GEARSHIFT CONTROL ROD (fig. 55). Position rod between gearshift hand lever and gearshift shaft. Secure with the clevis pin, flat washer, and cotter pin at each end.

98. REMOVAL.

- a. Remove Deck Platform (par. 94).
- b. Remove Gearshift Control Rod (par. 97).
- c. Remove Declutch Shift Control Rod (fig. 55) (par. 97).
- d. Disconnect Declutch Shift Lever (par. 97).
- e. Disconnect Front Axle Propeller Shaft (par. 101).
- f. Disconnect Rear Axle Propeller Shaft and Brake Disk (par. 102).
- g. Remove Intermediate Propeller Shaft (par. 103).
- h. Remove Propeller Shaft Brake Rod (par. 132).
- i. Disconnect Speedometer Cable (par. 172).
- j. Disconnect Transfer Case Front Crossmember. Remove the four nuts, lock washers, and bolts which secure crossmember and transfer case support tube slits to frame side rail on each side.

PROPELLER SHAFTS AND UNIVERSAL JOINTS

k. **Remove Transfer Case.** Attach rope sling and chain fall to transfer case. Remove wire seal and the two bolts, lock washers, and nuts which secure transfer case front support to transfer case crossmember on each side. Remove the wire seal, two cap screws, and lock washers which secure transfer case rear support to transfer case. Slide front crossmember forward. Pull transfer case forward and lower to floor. Slide case out from under vehicle.

99. INSTALLATION.

a. **Install Transfer Case On Front and Rear Crossmembers.** Attach rope sling to transfer case, and slide case under vehicle. Attach chain fall to sling, and raise transfer case to position on front and rear crossmembers. Insert and tighten the two cap screws and lock washers which secure transfer case to rear support. Install wire seal to the two screws. Install the two bolts, lock washers, nuts, and wire seal which secure transfer case front support to transfer case crossmember on each side. Remove rope sling.

b. **Connect Transfer Case Front Crossmember.** Install the four bolts, lock washers, and nuts which secure crossmember and transfer case support tube shim to frame side rail on each side.

c. **Connect Speedometer Cable** (par. 172).

d. **Install Propeller Shaft Brake Rod** (par. 132).

e. **Install Intermediate Propeller Shaft** (par. 103).

f. **Connect Rear Axle Propeller Shaft, and Install Brake Disk** (par. 102).

g. **Connect Front Axle Propeller Shaft** (par. 101).

h. **Connect Declutch Shift Lever** (par. 97).

i. **Connect Declutch Shift Control Rod** (par. 97).

j. **Install Gearshift Control Rod** (par. 97).

k. **Install Deck Platform** (par. 95).

Section XXIII

PROPELLER SHAFTS AND UNIVERSAL JOINTS

100. DESCRIPTION AND TABULATED DATA.

a. **Description** (fig. 56). Three propeller shafts transmit engine power to the driving axles. One shaft connects transmission and transfer case. Two long shafts connect transfer case to front and rear axles. Each propeller shaft has two universal joints. A slip

4- TO 5-TON 4x4 TRACTOR TRUCK (AUTOCAR MODEL U-7144T)

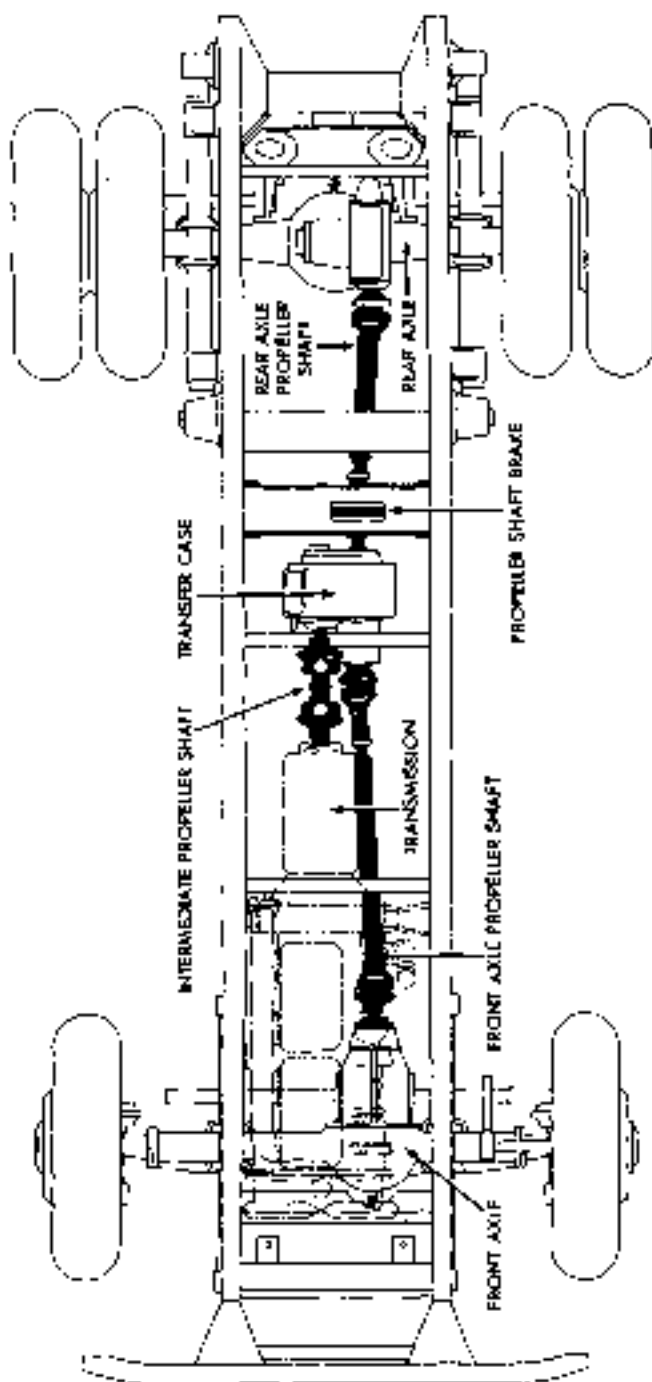

EA PD 77346

Figure 56 - Propeller Shaft Lay-out

PROPELLER SHAFTS AND UNIVERSAL JOINTS

TRANSFER CASE



FRONT AXLE PROPELLER SHAFT

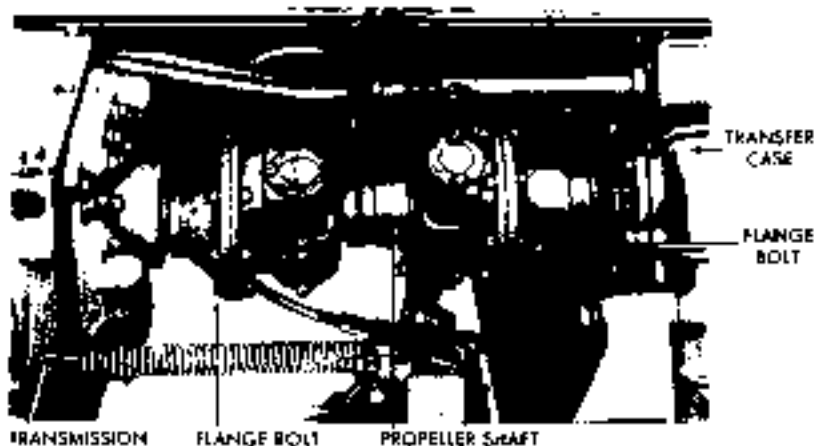

INTERMEDIATE PROPELLER SHAFT

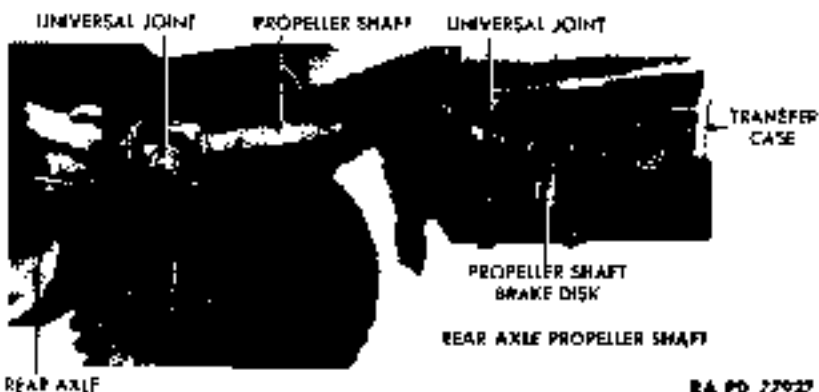

REAR AXLE PROPELLER SHAFT

RA 90 27027

Figure 57 -- Propeller Shafts Installed

4- TO 5-TON 4 x 4 TRACTOR TRUCK (AUTOCAR MODEL U-7144T)

joint at the end of each shaft nearest the center of the vehicle allows the axles to move forward and backward.

b. Tabulated Data.

Manufacturer	Spicer
Model of joint:	
Transmission to transfer case	1600 series
Transfer case to rear axle	1600 series
Transfer case to front axle	1500 series

101. FRONT AXLE PROPELLER SHAFT AND UNIVERSAL JOINTS.

a. **Removal** (fig. 57). Remove the four flange bolts, nuts, and lock washers at each end which secure shaft to transfer case and front axle. Remove shaft.

b. **Installation** (fig. 57). Position shaft between transfer case and front axle. Install the four bolts, nuts, and lock washers which secure shaft at each end, and tighten flange bolts alternately.

102. REAR AXLE PROPELLER SHAFT AND UNIVERSAL JOINTS.

a. **Removal** (fig. 57). Remove the eight nuts, lock washers, and bolts which secure shaft at each end to transfer case and to rear axle. Remove or support propeller shaft brake disk when removing propeller shaft.

b. **Installation** (fig. 57). Position shaft between rear axle and transfer case. Position propeller shaft brake disk between shaft and transfer case. Install the eight bolts, lock washers, and nuts at each end which secure shaft to rear axle and transfer case.

103. INTERMEDIATE PROPELLER SHAFT AND UNIVERSAL JOINTS.

a. **Removal** (fig. 57). Remove the eight nuts, lock washers, and bolts at each end which secure shaft to transfer case and to transmission, and remove shaft.

b. **Installation** (fig. 57). Position shaft between transfer case and transmission. Install the eight bolts, lock washers, and nuts at each end which secure shaft to transfer case and to transmission.

Section XXIV

FRONT AXLE

104. DESCRIPTION AND TABULATED DATA.

a. **Description** (fig. 58). The front axle is attached to frame through front springs. A gear carrier unit mounted on top of axle off center, permits propeller shaft to pass engine on left side and gives full road clearance. The axle housing is jointed at outer ends to permit full turning radius. A three-piece steering cross tube with threaded ends controls steering synchronization and toe-in. Different thread pitches on each end of cross tube permit close adjustment of toe-in.

b. **Tabulated Data.**

Front Axle:

Manufacturer	Tiarken
Model	F-2090-W-73-X-2
Type	Full floating

105. ADJUSTMENT.

a. **Toe-in Test.** Position wheels straight ahead. Mark both tires at front tire center lines, and measure distance between lines. Measure distance from floor to point from which cross measurement was taken on tire. Move vehicle forward until tire markings are at rear and at same height from floor as front measurements, then measure distance between center lines. Difference between front and rear cross measurements indicates amount of toe-in. The correct toe-in is $\frac{3}{16}$ inch to $\frac{5}{16}$ inch. Adjust if necessary (subpar. b, below).

b. **Toe-in Adjustment** (fig. 58). Remove the cotter pin, lock nut, and steering cross tube end pin which secure cross tube to wheel assembly. Loosen the two cross tube end clamp bolt nuts and bolts, and turn yoke end to increase or decrease toe-in. Left-hand tube end has 12 threads per inch, right-hand end 16 threads per inch. When toe-in of $\frac{3}{16}$ inch to $\frac{5}{16}$ inch is attained, position tube end to wheel assembly. Install tube end pin, and secure with the end pin nut and cotter pin. Tighten cross tube end lock nut, then tighten tube end clamp bolts and bolt nuts.

106. REMOVAL (fig. 58).

a. **Anchor Vehicle and Raise Front End.** Set propeller shaft brake to prevent vehicle from moving. Attach suitable lifting tackle to bumper, if jacks are used, positioning jacks to frame at rear of front spring. Raise vehicle sufficiently to take weight off springs.

4- TO 5-TON 4x4 TRACTOR TRUCK (AUTOCAR MODEL U-7144T)

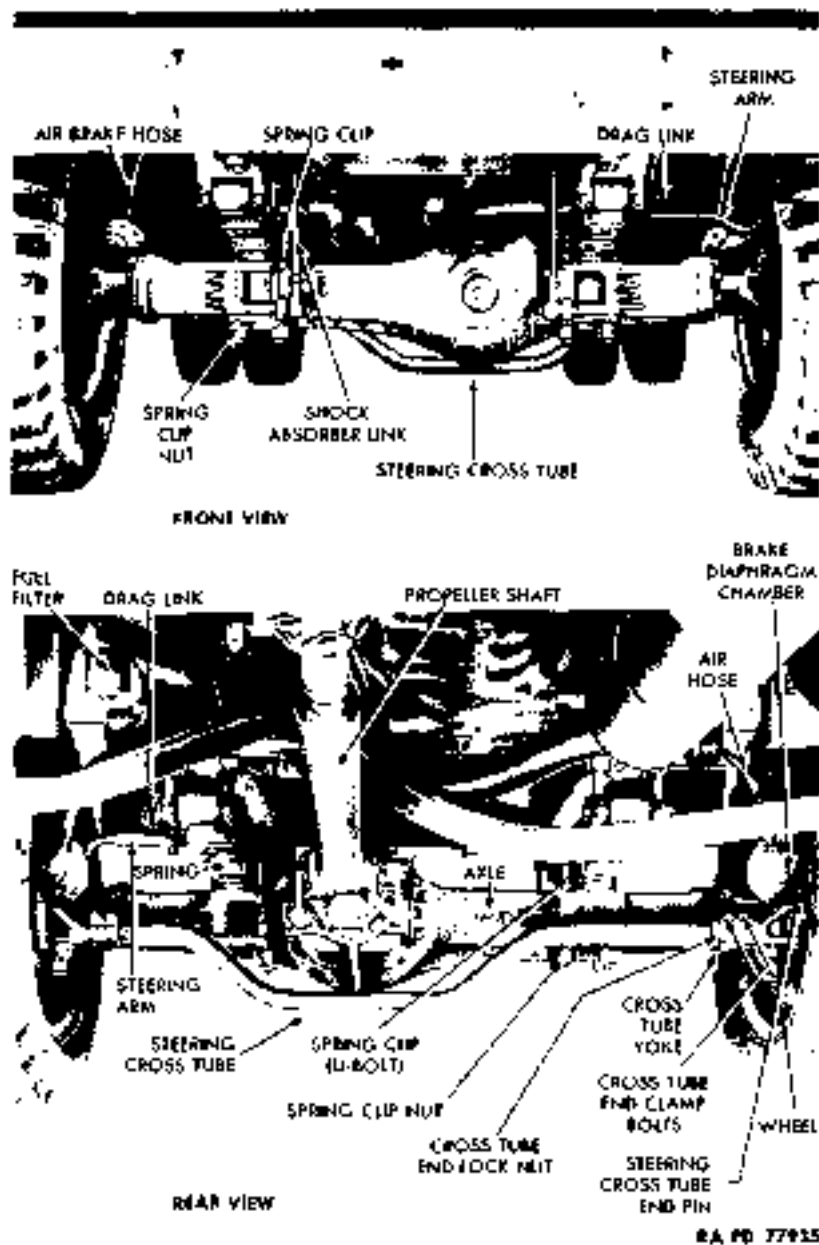

Figure 58 — Front Axle Installed

REAR AXLE

- h. **Disconnect Air Brakes** (par. 116).
- c. **Disconnect Shock Absorbers** (par. 138).
- d. **Disconnect Front Axle Propeller Shaft** (par. 101).
- e. **Disconnect Steering Drag Link at Axle Ball Arm** (par. 142).
- f. **Remove Spring Clips** (par. 136).
- g. **Remove Axle From Vehicle.** Lift chassis high enough to disengage springs from axle. Wheel the axle assembly from vehicle.
- h. **Remove Steering Cross Tube** (fig. 58). Remove the two cotter pins, tube end pin nuts, and tube end pins which secure cross tube to wheel assemblies. Remove cross tube.
- i. **Remove Front Wheels** (par. 133).

107. INSTALLATION (fig. 58).

- a. **Install Front Wheels** (par. 133).
- b. **Install Steering Cross Tube** (fig. 58). Position tube to wheel assemblies, and install tube end pin at both ends. Secure with the two end pin nuts and cotter pins.
- c. **Position Axle Under Vehicle.** Roll axle into position under front springs so spring clips may be installed. Lower chassis until springs contact axle housing.
- d. **Install Spring Clips** (par. 136).
- e. **Connect Steering Drag Link at Axle Ball Arm** (par. 142).
- f. **Connect Front Axle Propeller Shaft** (par. 101).
- g. **Connect Shock Absorbers** (par. 138).
- h. **Connect Air Brakes** (par. 116).
- i. **Remove Lifting Apparatus.** Lower vehicle to floor. Remove lifting device, and release propeller shaft brake.

Section XXV

REAR AXLE

108. DESCRIPTION AND TABULATED DATA.

- a. **Description** (fig. 59). The rear axle is the double-reduction type, with the unicast axle housing having inserted tubes which carry the vehicle's weight, thus providing full floating drive. A detachable gearset unit is mounted in a gear carrier on the axle housing.

4- TO 5-TON 4x4 TRACTOR TRUCK (AUTOCAR MODEL U-7144T)

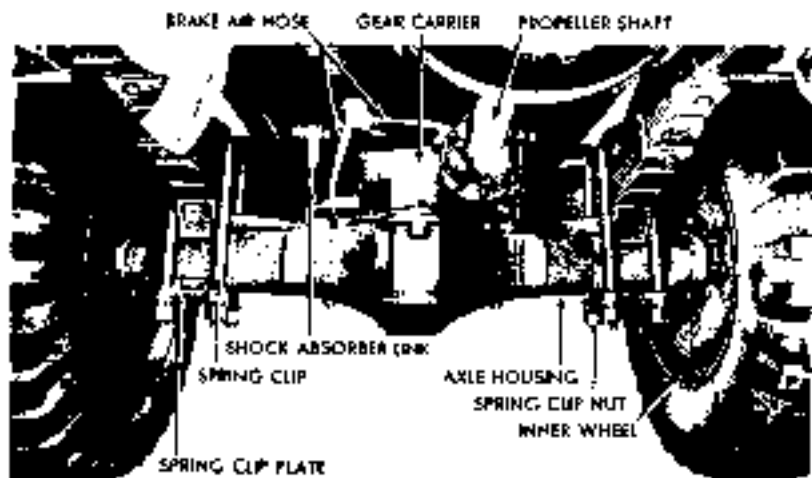

FRONT VIEW

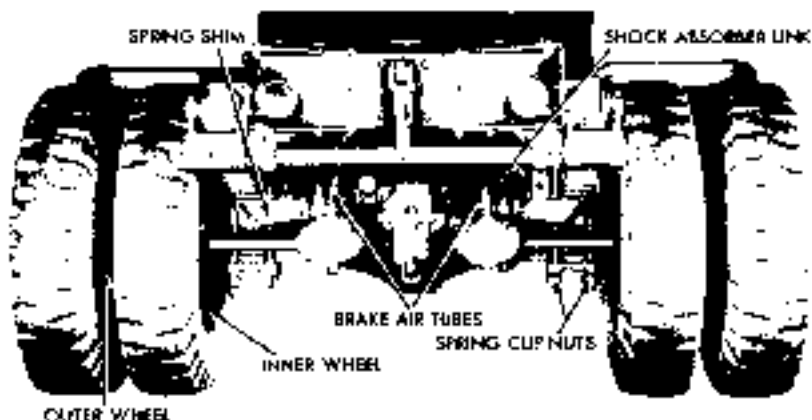

REAR VIEW

RA PD 77928

Figure 59 - Rear Axle Installed

SERVICE BRAKE SYSTEM

b. Tabulated Data.

Rear Axle:

Manufacturer	Timken
Model	R-2090-W-X-1
Type	Full floating

109. REMOVAL (fig. 59).

- a. **Disconnect Rear Axle Propeller Shaft** (par. 102).
- b. **Disconnect Brake Air Hose** (par. 116).
- c. **Disconnect Shock Absorber Link at Spring Clip Plate.** Disconnect link, and remove spring clip nuts (par. 138).
- d. **Remove Chassis from Axle.** Attach suitable lifting equipment to frame of rear cross member. Lift chassis from axle, and roll axle from vehicle.
- e. **Remove Wheels** (par. 133).

110. INSTALLATION (fig. 59).

- a. **Install Wheels** (par. 133).
- b. **Lower Chassis to Axle** (fig. 59). Position axle under rear end of chassis so that spring clips line up with holes in rear spring clip plate. Lower chassis to axle.
- c. **Connect Shock Absorber Link to Spring Clip Plate.** Install spring clip nuts, and connect shock absorber link to spring clip plate (par. 138).
- d. **Connect Brake Air Hose** (par. 116).
- e. **Connect Rear Axle Propeller Shaft** (par. 102).

Section XXVI

SERVICE BRAKE SYSTEM

111. DESCRIPTION (fig. 60).

a. The air brake equipment operates the brakes on the wheels of the tractor and trailer. It also furnishes compressed air for such uses as inflating tires and operating the windshield wipers. The air is compressed and stored in two air reservoirs. Forced through air lines under pressure, it is admitted by valves to brake diaphragm chambers mounted on the axles. These diaphragms, which are connected to the brake shoes by push rods and slack adjusters, apply the shoes to the

4- TO 5-TON 4x4 TRACTOR TRUCK (AUTOCAR MODEL U-7144T)

RA PD 77963

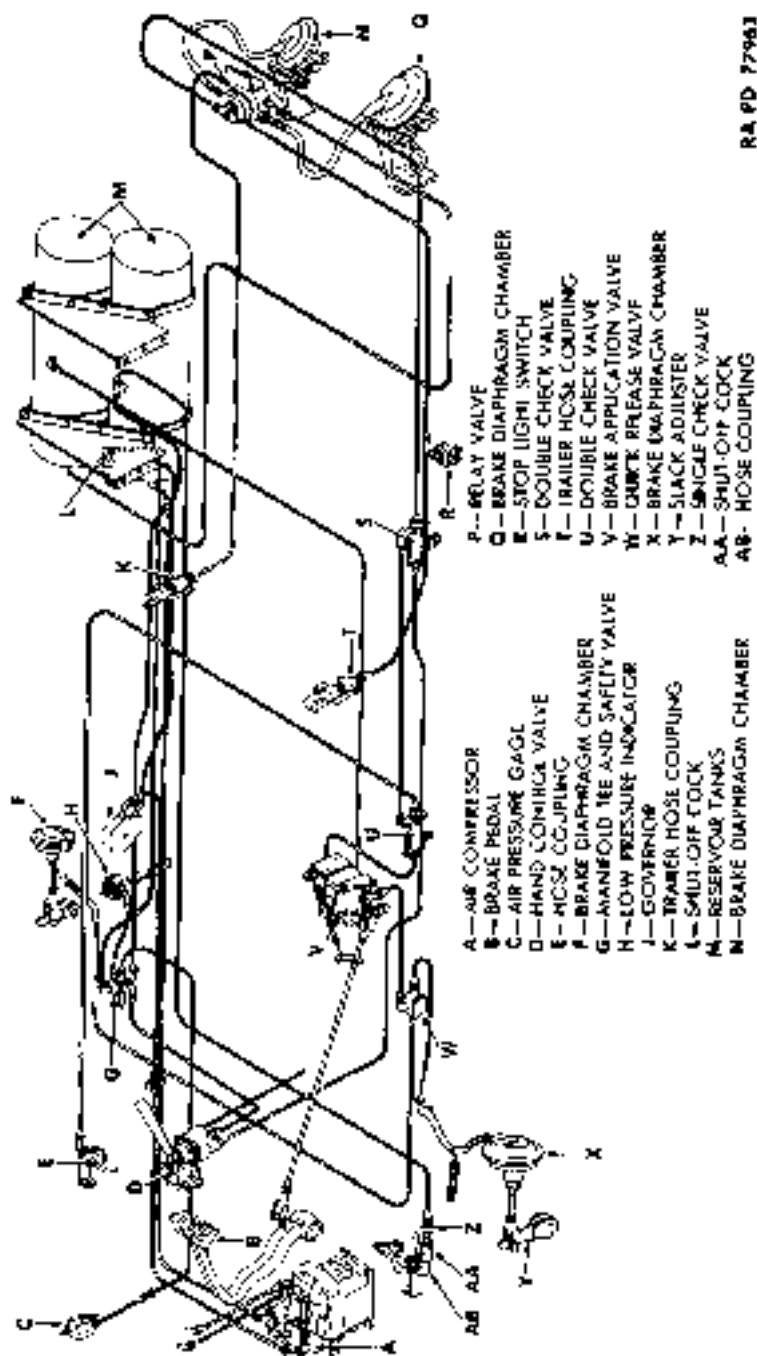

- A—AIR COMPRESSOR
- B—BRAKE PEDAL
- C—AIR PRESSURE GAGE
- D—HAND CONTROL VALVE
- E—HOSE COUPLING
- F—BRAKE DIAPHRAGM CHAMBER
- G—MANIFOLD TEE AND SAFETY VALVE
- H—LOW PRESSURE INDICATOR
- I—GOVERNOR
- J—TRAILER HOSE COUPLING
- K—SHUT-OFF COCK
- L—RESERVOIR TANKS
- M—BRAKE DIAPHRAGM CHAMBER
- N—BRAKE DIAPHRAGM CHAMBER
- P—RELAY VALVE
- Q—BRAKE DIAPHRAGM CHAMBER
- R—STOP LIGHT SWITCH
- S—DOUBLE CHECK VALVE
- T—TRAILER HOSE COUPLING
- U—DOUBLE CHECK VALVE
- V—BRAKE APPLICATION VALVE
- W—BRAKE RELEASE VALVE
- X—BRAKE DIAPHRAGM CHAMBER
- Y—SLACK ADJUSTER
- Z—SINGLE CHECK VALVE
- AA—SHUT-OFF COCK
- AB—HOSE COUPLING

Figure 60 — Service Brake System

SERVICE BRAKE SYSTEM

brake drums in proportion to the air pressure admitted to the diaphragm chambers. The braking air pressure is controlled by a system of valves and control units. Principal units of the system are: air compressor, governor, reservoir tanks, safety valve, brake application valve, hand control valve, relay valve, quick release valve, double check valves, single check valves, brake diaphragm chambers, manifold tee, slack adjusters, brake shoes, brake pedal, tubing, and hose.

112. AIR COMPRESSOR.

a. Description and Tabulated Data.

(1) **DESCRIPTION** (fig. 61). The air compressor unit is mounted on left side of engine, and is driven by engine fan belts. It can be reached by removing left-hand toeboard and toeboard insert. The 2-cylinder pump builds up air pressure in the two reservoir tanks to operate brakes and air accessories. The pump is lubricated through direct connection with the engine pressure system and cooled by the engine cooling system. Modified cooling fins also are located on exterior of compressor cylinders.

(2) TABULATED DATA.

Manufacturer	Westinghouse
Model	2 UE 7 1/4 VW
Capacity	7 1/4 cu ft

b. Maintenance and Adjustment.

(1) **CLEAN COMPRESSOR AIR CLEANER** (figs. 61 and 62). Remove snap ring, and pull element from compressor air cleaner. Clean curled hair element in dry-cleaning solvent, dry completely, not lightly, and replace element in cleaner.

(2) **INSPECT VALVES AND VALVE MECHANISM** (fig. 61). Check unloader valve rocker arm movement. Oil the fulcrum pin, and check unloader valve clearance. Correct clearance is 0.010 inch to 0.015 inch. If not within these limits, notify higher authority.

(3) **CHECK FOR CARBON**. Remove cap nuts, and check discharge valve seats for carbon. If carbon is excessive, remove cylinder head and clean carbon from valve seats, chambers, and springs. Use new gasket and install head.

c. Removal.

(1) **REMOVE FLOOR BOARD, TOEBOARD, AND TOEBOARD INSERT** (fig. 19). Remove the seven screws and lock washers which attach left-hand floor board to cab, and lift floor board out. Remove the six screws and lock washers which attach left-hand toeboard, and lift toeboard from cab. Remove the four screws and lock washers which attach toeboard insert, and remove insert.

4. TO 5-TON 4x4 TRACTOR TRUCK (AUTOCAR MODEL U-71447)

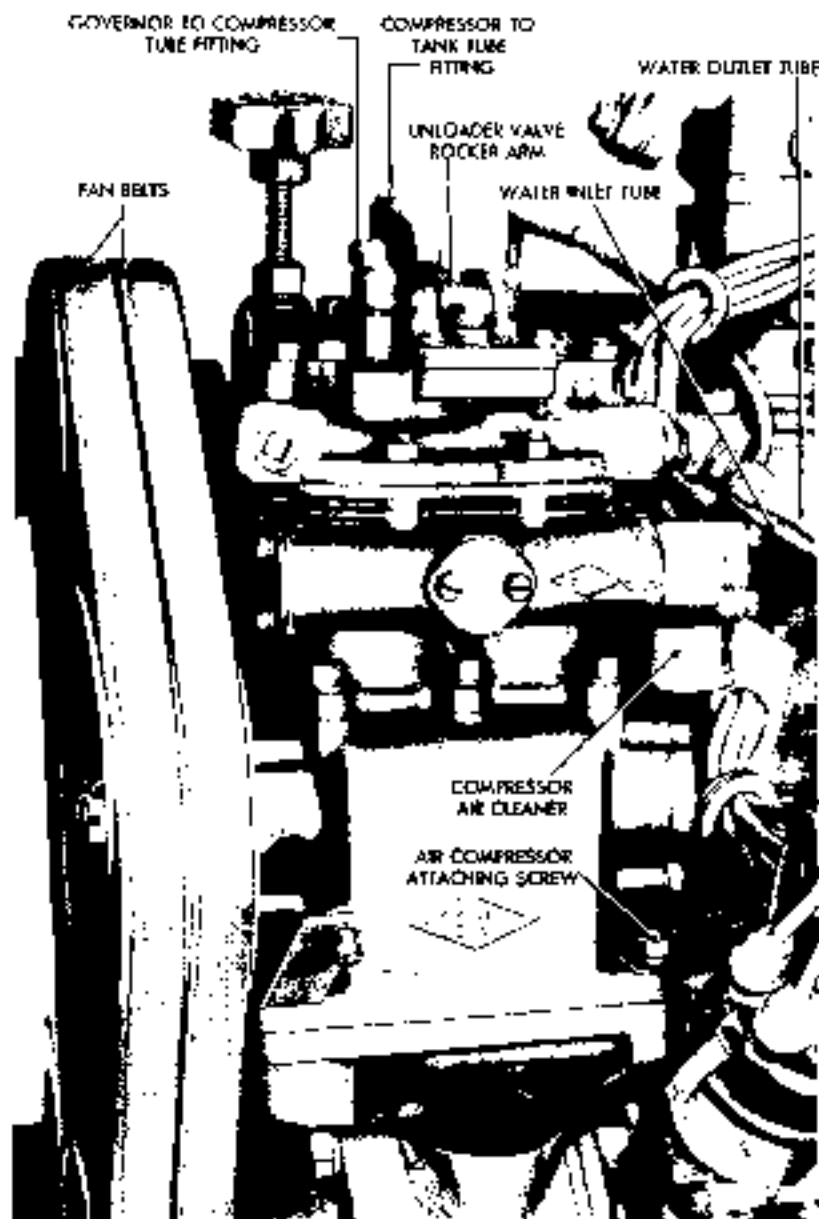

RA PD 77898

Figure 61 - Air Compressor Mounted on Engine

SERVICE BRAKE SYSTEM

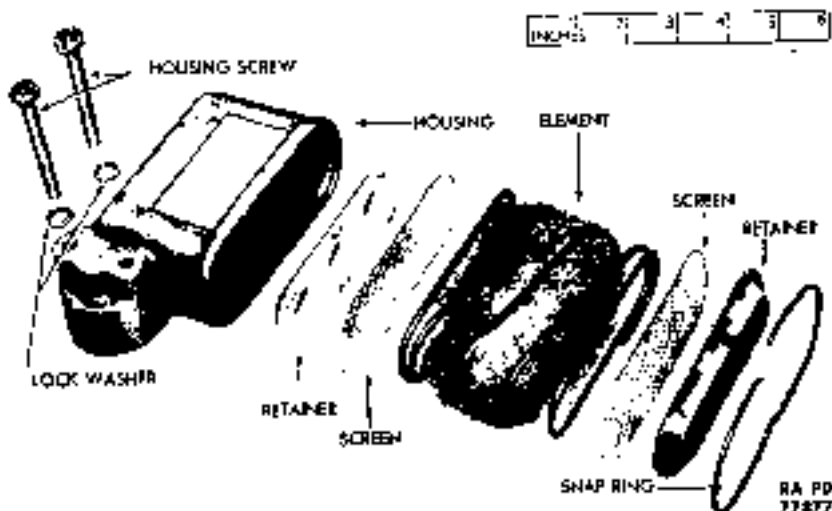

Figure 62 – Air Compressor Air Cleaner Disassembled

- (2) REMOVE FAN BELTS (fig. 61) (par. 78).
- (3) DRAIN ENGINE COOLING SYSTEM (par. 73).
- (4) DISCONNECT WATER LINES (fig. 61). Disconnect water inlet and outlet lines from fittings on compressor. Disconnect compressor to tank tube, and governor to compressor tube from fittings on compressor.
- (5) DETACH COMPRESSOR (fig. 61). Remove the four air compressor attaching screws and lock washers, and lift compressor and gasket from bracket.

d. Installation (fig. 61).

- (1) Spread a thin film of No. 2 general purpose grease over both sides of new air compressor bracket gasket, and place gasket in position on bracket. Position compressor on gasket, and install the four lock washers and air compressor attaching screws.
- (2) CONNECT AIR LINES (fig. 61). Connect compressor-to-tank tube to main discharge fitting, and governor-to-compressor tube to its outlet elbow. Connect water inlet tube to air compressor inlet elbow, and water outlet tube to compressor water discharge connector.
- (3) INSTALL FAN BELTS (fig. 61) (par. 78).
- (4) FILL ENGINE COOLING SYSTEM. Close both drain cocks, and fill system completely (par. 73).
- (5) TEST INSTALLATION. Start engine, and allow to run until a full 105 pounds of air pressure builds up; then inspect connections for leaks.

4- TO 5-TON 4 x 4 TRACTOR TRUCK (AUTOCAR MODEL U-7344T)

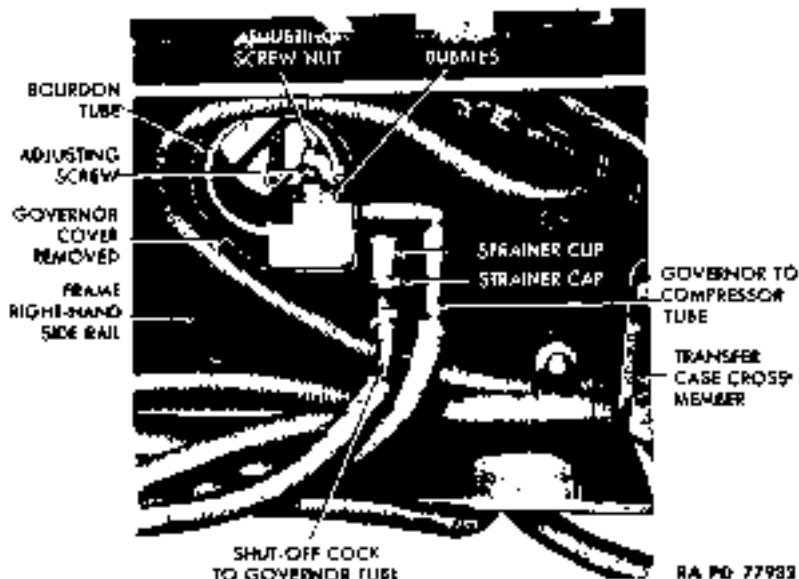

Figure 63 - Testing Air Pressure Regulator Governor With Cover Removed

(6) INSTALL TOEBOARD INSERT, TOEBOARD, AND FLOOR BOARD (fig. 19). Place toeboard insert in position, and install the four lock washers and screws which hold it to cab. Position toeboard, and install the six lock washers and screws which secure it. Place floor board in position, and install the seven lock washers and screws which secure it to cab.

113. GOVERNOR.

a. Description and Tabulated Data.

(1) DESCRIPTION (figs 65 and 63). The governor is located on inside of main frame right-hand side rail approximately even with front edge of frame platform, and can be reached from under the truck. Two lines connect to it, one leading to the compressor, and the other to the manifold, by way of a shut-off cock in front of the two reservoir tanks. The governor controls pressure of the air system by opening unloader valves in the compressor, when a pressure of 105 pounds is reached and closing them when a minimum pressure of 85 pounds is reached. Pressure from the air reservoir tanks, routed through the manifold, operates the governor.

SERVICE BRAKE SYSTEM

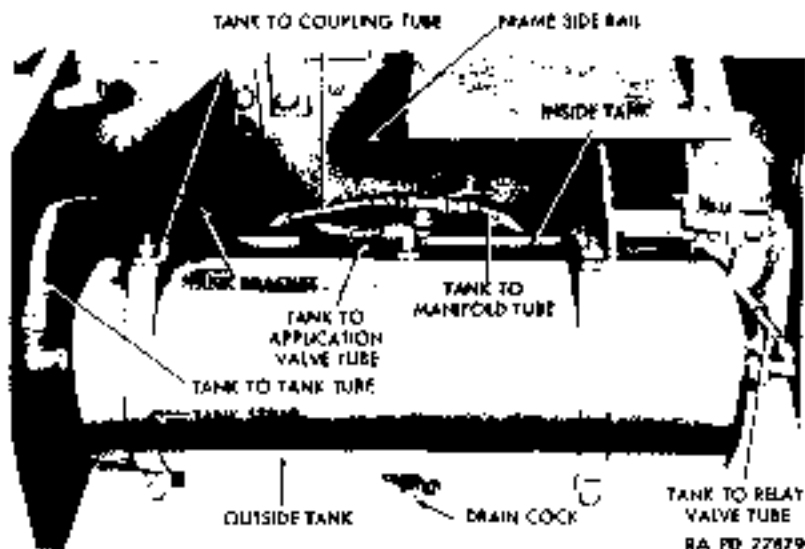

Figure 64 - Air Reservoir Tanks Installed

(2) **TABULATED DATA.**

Manufacturer	Westinghouse
Model	0-1

b. **Maintenance and Adjustment (fig. 63).** Close shut-off cock on bracket in front of reservoir tanks, and remove shut-off cock to governor tube from governor. Screw strainer cap from strainer cup, and pull strainer from cup. Wash strainer in gasoline, then install strainer and strainer cap. Connect tube to governor, and open shut-off cock. Start engine, and observe pressures at which governor cuts out and in. If it does not cut in at 85 pounds and cut out at approximately 105 pounds, remove case cover, loosen adjusting screw nut, and turn adjusting screw clockwise to raise cut-in pressure or counterclockwise to lower cut-in pressure. Tighten adjusting screw nut, and install case cover. Allow governor to cut out, and check upper valve for leakage by covering exhaust port with snapnuts; then allow governor to cut in, and test lower port in same manner. Leakage of a 3-inch bubble in 3 seconds is permissible. In case of excessive leakage, replace governor (subpar. d, below). Remove case cover, and lubricate valve stem with a few drops of penetrating oil.

c. **Removal.**

(1) **DISCONNECT TUBING (fig. 65).** Screw shut-off cock to governor tube from governor. Unscrew governor to compressor tube from governor.

4. TO 5-TON 4x4 TRACTOR TRUCK (AUTOCAR MODEL U-7144T)

(2) **DETACH GOVERNOR FROM FRAME** (fig. 65). Remove the two nuts, lock washers, and bolts which attach governor to frame. Lift governor from frame.

d. Installation.

(1) **ATTACH GOVERNOR TO FRAME** (fig. 65). Place governor in position on frame, and install the two bolts, lock washers, and nuts which attach governor to frame.

(2) **CONNECT TUBING** (fig. 65). Screw governor to compressor tube nut onto upper fitting on governor, and screw shut-off cock to governor tube nut onto strainer cap.

(3) **TEST OPERATION**. Start engine, and observe pressures at which governor cuts out and in. Adjust if necessary (subpar. 1, above).

114. RESERVOIR TANKS.

a. Description and Tabulated Data.

(1) **DESCRIPTION** (fig. 64). The two reservoir tanks are attached to brackets on the outside of main frame right-hand side rail between cab and tool box. Each tank is equipped with a drain cock, and a tank-to-tank tube connects the tanks together at the rear. Their function is to store compressed air to operate service brakes and air accessories.

(2) TABULATED DATA.

Manufacturer	Westinghouse
Model	217321
Length	26 in.
Diameter	8 in.

b. **Removal** (fig. 64). Open drain cock on lower center of tank, and allow all air to escape. Disconnect all tubing from fittings on tank. Remove the two nuts, lock washers, and clamp bolts which clamp tank straps together under tank. Spread straps, and lower tank from brackets.

c. **Installation** (fig. 64). Place tank in position under its brackets. Install the two clamp bolts, lock washers, and nuts which clamp tank straps together under tank, and connect tubing to fittings on tank.

115. SAFETY VALVE.

a. Description and Tabulated Data.

(1) **DESCRIPTION** (fig. 65). A safety valve is screwed into one of the openings on the manifold tee, to protect the air system against damage from excessive pressure in case of pressure control system failure. A coil spring holds a ball valve on its seat, and an adjustable spring seat regulates spring tension.

SERVICE BRAKE SYSTEM

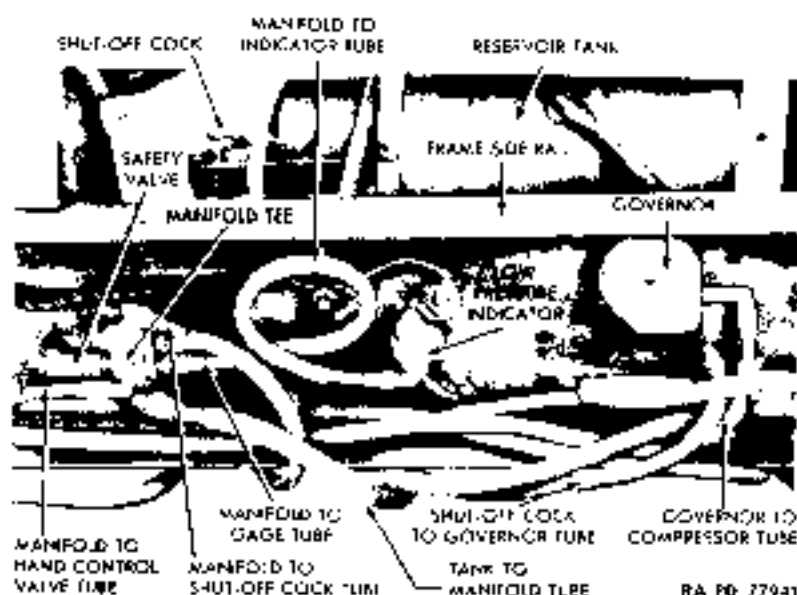

RA PD 779-1

Figure 65 — Brake Air System Components

(2) TABULATED DATA.

Manufacturer	Westinghouse
Model	205105
Operating pressure	150 lb

b. **Removal** (fig. 65). Open drain cock (fig. 37) on reservoir tank, working from under truck. Unscrew valve from manifold tee.

c. **Installation** (fig. 65). Screw valve into its opening on manifold tee, and close drain cock (fig. 37) on bottom of reservoir tank.

116. BRAKE APPLICATION VALVE.

a. Description and Tabulated Data.

(1) **DESCRIPTION** (fig. 66). The brake application valve is mounted on a bracket on inside of main frame left-hand side rail under front edge of frame platform, and is connected by a rod to the brake pedal. When pedal is depressed, the valve admits air to brake diaphragm chambers to operate brakes. When pedal is released, the valve exhausts pressure from brake diaphragm chambers to release brakes. Amount of pressure built up or exhausted is in direct proportion to amount of pedal travel.

4. TO 5-TON 4x4 TRACTOR TRUCK (AUTOCAR MODEL U-7144T)

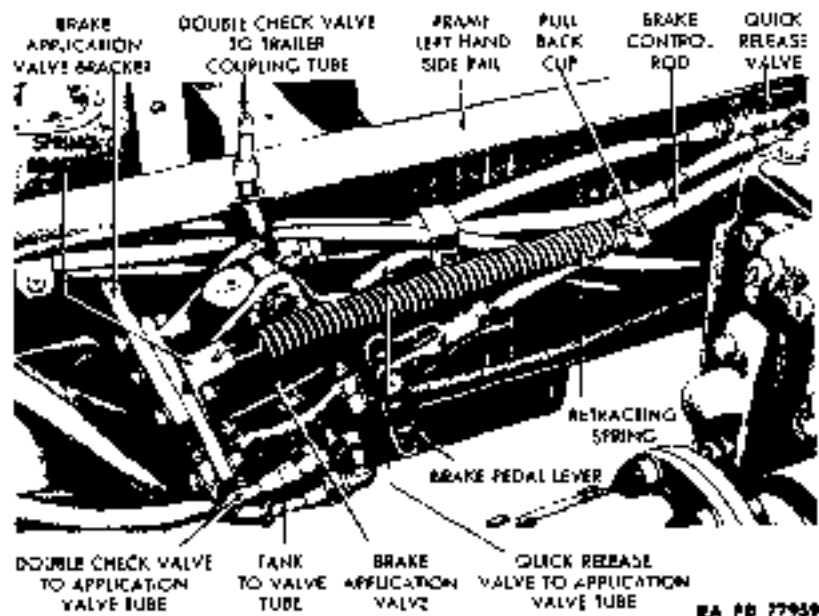

Figure 66 — Brake Application Valve Installed

(2) TABULATED DATA.

Manufacturer	Westinghouse
Type	B4A
Model	216213

b. Removal (fig. 66).

(1) **DETACH BRAKE CONTROL ROD.** Snap retracting spring from pull-back clip on brake control rod and from bracket on valve. Remove cotter pin, flat washer, and clevis pin which attach rod to valve.

(2) **DISCONNECT AIR LINES.** Disconnect all three air tubes from fittings on valve.

(3) **DETACH VALVE FROM BRACKET.** Remove all four nuts, lock washers, and bolts which attach valve to bracket. Lift valve and spring bracket from valve bracket.

c. Installation (fig. 66).

(1) **ATTACH VALVE TO BRACKET.** Position valve on bracket, and install the four bolts, lock washers, and nuts which attach valve to bracket. Place spring bracket under nut and washer on top right bolt.

(2) **CONNECT AIR LINES.** Connect double check valve to application valve tube to fitting on right-hand side of valve. Connect tank to valve tube to fitting on bottom of valve. Connect quick release valve to application valve tube to fitting on left side of valve.

SERVICE BRAKE SYSTEM

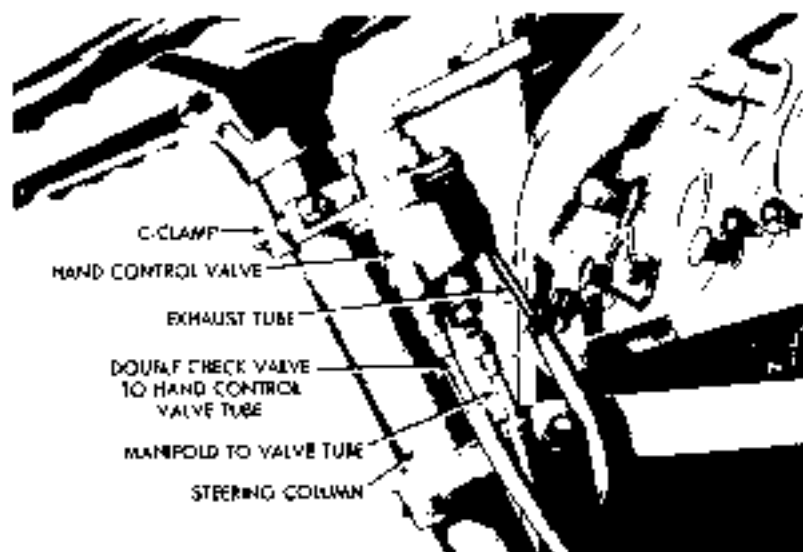

NA PD 3795B

Figure 67 - Air Brake Hand Control Valve Installed

(3) **CONNECT BRAKE CONTROL ROD.** Place yoke on end of rod in position on hole second from top in brake pedal lever, and install clevis pin, flat washer, and cotter pin. Slide pull-back clip toward valve on brake control rod. Hook retracting spring onto pull-back clip and onto bracket on valve. Slide pull-back clip up on brake control rod until spring is under definite tension.

(4) **TEST INSTALLATION.** Start engine and build up 105 pounds of pressure, then operate brakes. Check valve fittings for leaks.

117. HAND CONTROL VALVE.

a. Description and Tabulated Data.

(1) **DESCRIPTION** (fig 67). A hand control valve, located on steering column immediately below steering wheel, is used to operate brakes on the trailer. This valve consists of an intake valve and exhaust valve combined in a single-piece stem. Movement of the lever toward "ON" position forces a piston downward toward an exhaust seat, closing the exhaust valve and opening the intake valve. Movement of lever to "OFF" position removes downward force on piston, and exhaust valve opens while intake valve closes.

(2) **TABULATED DATA.**

Manufacturer	Westinghouse
Type	HP
Model	215748

4. TO 5-TON 4 x 4 TRACTOR TRUCK (AUTOCAR MODEL U-7144T)

h. Removal (fig. 67). Disconnect all three air tubes from fittings on valve. Remove the two nuts, lock washers, and bolts which hold valve to steering column, and lift valve and C-clamp from steering column.

c. Installation (fig. 67). Place valve and C-clamp in position on steering column. Install both bolts, lock washers, and nuts which clamp valve and C-clamp together around steering column. Connect manifold to valve tube to fitting on bottom center of valve. Connect double check valve to hand control valve tube to fitting at edge of under side of valve. Connect exhaust tube to elbow on side of valve. Start engine and build up 105 pounds of pressure, then apply trailer brakes. Check valve connections for leaks.

118. RELAY VALVE.

a. Description and Tabulated Data.

(1) **DESCRIPTION (fig. 86).** A relay valve, attached to rear cross-member top right-hand gusset, can be reached from under the truck behind the rear axle. This valve acts as a relay station to speed up application and release of rear wheel brakes and trailer brakes.

(2) **TABULATED DATA.**

Manufacturer Westinghouse
Model 217383

h. Removal (fig. 86). Disconnect all six air lines from valve. Remove the two nuts, lock washers, and bolts which secure valve to bracket, and lift valve from bracket.

c. Installation (fig. 86). Position valve on bracket, and install the two bolts, lock washers, and nuts which attach valve to bracket. Connect the two relay valve-to-diaphragm hose to the two large fittings on sides of valve. Connect valve to stop light switch tube and double check valve to relay valve tube to tee on top of valve. Connect valve to trailer coupling tube to fitting on right-hand side of valve. Connect tank to valve tube to fitting on left-hand side of valve. Start engine and build up maximum air pressure, then apply brakes and check valve for leaks.

119. QUICK RELEASE VALVE.

a. Description and Tabulated Data.

(1) **DESCRIPTION (fig. 16).** A quick release valve is attached to the inside of frame left-hand side rail approximately even with engine oil filter. This valve is connected in the line from brake application valve to front wheel brake diaphragm chambers. Its function is to speed up front wheel brake release by venting exhaust air to atmosphere.

SERVICE BRAKE SYSTEM

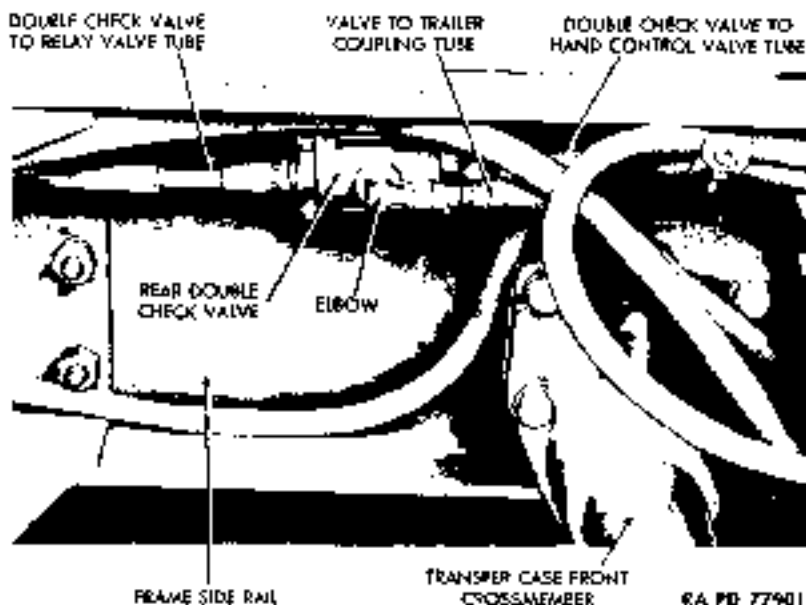

Figure 68 — Double Check Valve Installed

(2) **TABULATED DATA.**

Manufacturer	Westinghouse
Model	205000

b. **Removal** (fig. 16). Disconnect all three air tubes from fittings on valve. Remove the two nuts, lock washers, and bolts which attach valve to frame.

c. **Installation** (fig. 16). Position valve on frame, and install the two bolts, lock washers, and nuts which attach valve to frame. Connect brake application valve to quick release valve tube to fitting on top of valve. Connect tubes leading to front brake diaphragm chamber hose to fittings on ends of valve. Start engine and build up maximum air pressure, then apply brakes and inspect valve for leakage.

120. DOUBLE CHECK VALVES.

a. **Description and Tabulated Data.**

(1) **DESCRIPTION.** Two double check valves are attached to the left-hand frame side rail opposite transmission and transfer cases. These valves are used to prevent loss of air pressure through an open exhaust of the brake valves which are not being operated.

4- TO 5-TON 4x4 TRACTOR TRUCK (AUTOCAR MODEL U-7144T)

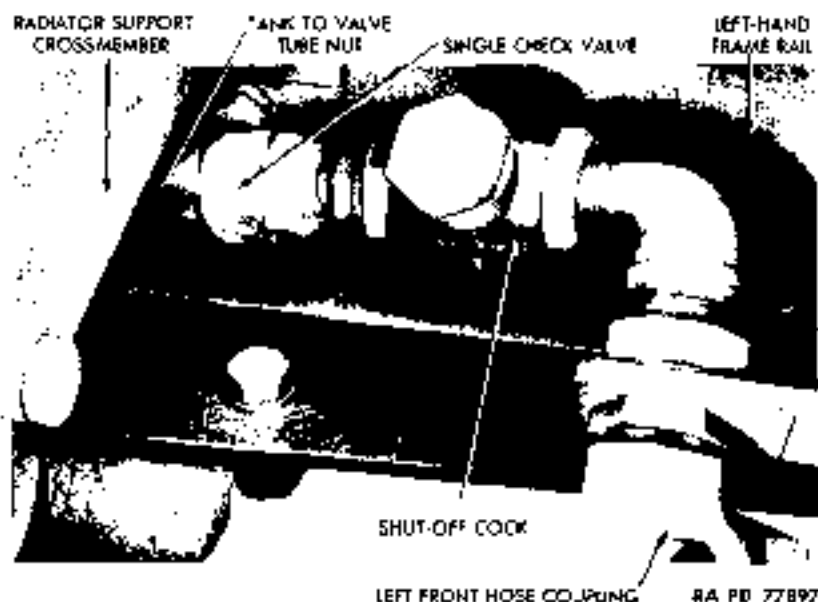

Figure 69 — Single Check Valve and Attaching Parts

(2) TABULATED DATA.

Manufacturer	Westinghouse
Model	217698

b. **Removal** (fig. 68). Disconnect the three air tubes from fittings at each end of valve and from elbow at center. Remove the two nuts, lock washers, and bolts which secure valves to frame side rail.

c. **Installation** (fig. 68). Position valve to frame side rail, and install the two bolts, lock washers, and nuts which secure valve to frame. Connect air tube to fitting at each end of valve. Connect air tube to elbow at center of valve, and refer to system diagram (fig. 60), if necessary. Start engine and build up air pressure. Check connections for leakage, and test operation of brakes. Leaks can be detected by applying soapy water to connections.

121. SINGLE CHECK VALVE.

a. **Description and Tabulated Data.**

(1) **DESCRIPTION** (fig. 69). A single check valve, attached to air line at shut-off cock behind front left hose coupling, is a one-way ball-type check valve. Its purpose is to prevent leakage of air system in case of coupling breakage while the truck is being towed.

SERVICE BRAKE SYSTEM

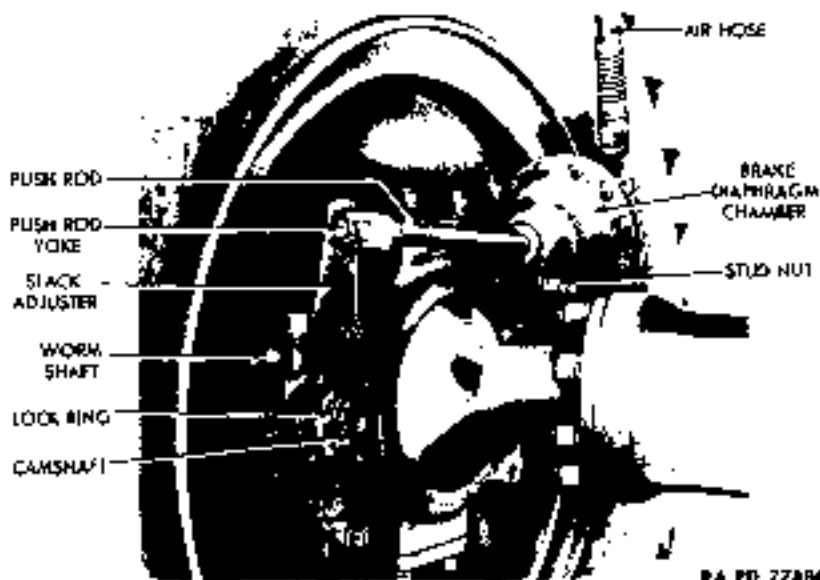

Figure 70 — Front Brake Diaphragm Chamber and Slack Adjuster Installed

(2) TABULATED DATA.

Manufacturer Westinghouse
Model 220306

b. **Removal** (fig. 69). Disconnect air tube from elbow at rear end of valve, and unscrew valve from fitting on shut-off cock.

c. **Installation** (fig. 69). Screw valve to connection on shut-off cock, and connect air line to elbow at rear of valve. Start engine, and build up pressure to 105 pounds. Inspect valve for leaks.

122. BRAKE DIAPHRAGM CHAMBERS.

a. **Description and Tabulated Data.**

(1) **DESCRIPTION** (figs. 70 and 74). One brake diaphragm is attached to vehicle adjacent to each of the four wheels. Diaphragms convert air pressure to mechanical motion in applying brakes. Depressing the brake pedal admits air pressure to each diaphragm chamber, and pressure causes diaphragm motion which is transmitted to brake cam by means of a push rod and slack adjuster. When brake pedal is released, pressure is exhausted from the chamber, and brakes are then released by a spring which returns slack adjuster, push rod, and diaphragm to their original position.

4- TO 5-TON 4x4 TRACTOR TRUCK (AUTOCAR MODEL U-7144T)

(2) TABULATED DATA.

Manufacturer : Westinghouse

Type:

Front E

Rear B

h. Removal.

(1) **DISCONNECT SLACK ADJUSTER** (figs 70 and 74). Remove cotter pin and clevis pin which connect slack adjuster to push rod yoke.

(2) **DISCONNECT AIR HOSE** (figs. 70 and 74). Screw hose nut from fitting on chamber.

(3) **DETACH CHAMBER** (figs. 70 and 74). Remove stud nut and lock washer which secures chamber at front wheel brake, or remove the four nuts, lock washers, and bolts which secure chamber at rear wheel brake. Lift chamber from vehicle.

e. Installation.

(1) **ATTACH CHAMBER** (figs. 70 and 74). Position chamber on backing plate or on bracket. Install stud nut which secures chamber at front wheel brake, or the four bolts, lock washers, and nuts which secure chamber at rear wheel brake.

(2) **CONNECT AIR HOSE** (figs. 70 and 74). Screw air hose to fitting on chamber.

(3) **CONNECT SLACK ADJUSTER** (figs. 70 and 74). Position slack adjuster to push rod yoke, and secure with the clevis pin and cotter pin.

(4) **TEST INSTALLATION.** Start engine, and build up pressure to 105 pounds. Test operation of brakes, and inspect chamber hose connection for leaks while brakes are in operation.

123. MANIFOLD TEE.

a. Description (fig. 65). A manifold tee, attached to the inside of right-hand frame side rail opposite the transmission, consists of a hollow metal block equipped with fittings to which air tubes are connected. It connects air tubes together so that air pressure in all tubes is equalized.

b. Removal (fig. 65). Disconnect the five air lines from fittings on manifold. Screw safety valve from manifold. Remove the two nuts, lock washers, and bolts which secure tee to frame side rail, and remove tee.

c. Installation (fig. 65). Position tee to frame side rail, and secure with the two bolts, lock washers, and nuts. Connect the five air lines to fittings on tee. Screw safety valve into its opening on manifold. Start engine, and build up pressure to 105 pounds. Check connections for leaks by applying soapy water.

SERVICE BRAKE SYSTEM

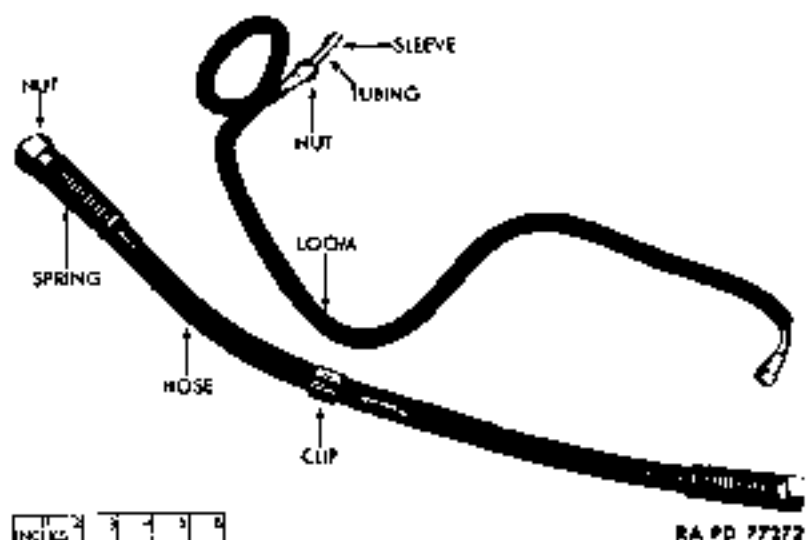

Figure 71 - Air System Tubing and Hose

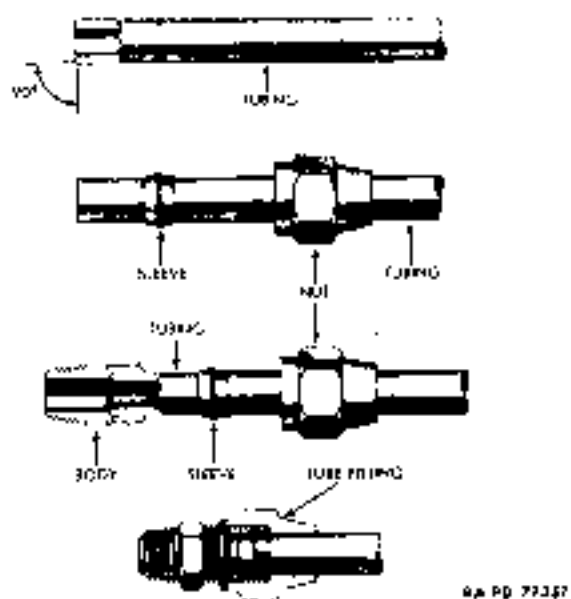

Figure 72 - Fitting and Tubing Installations

4- TO 5-TON 4 x 4 TRACTOR TRUCK (AUTOCAR MODEL U-7144T)

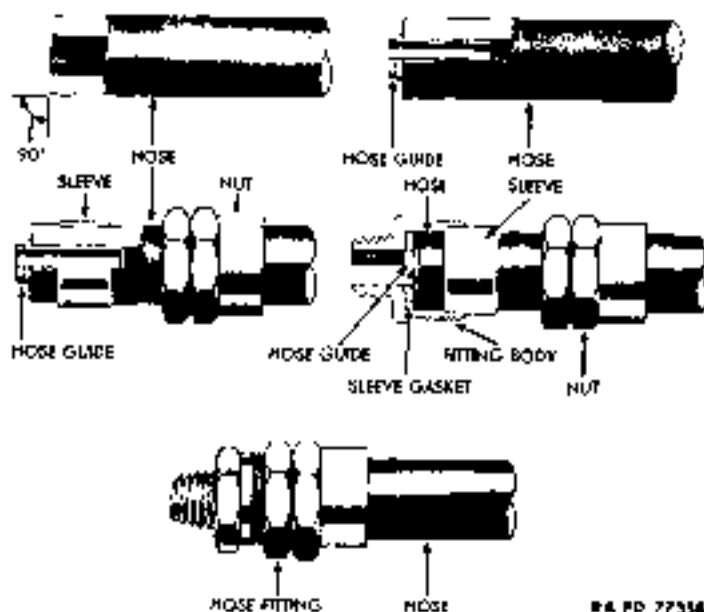

Figure 72 — Hose and fitting installations

124. TUBING AND HOSE.

a. **Description** (fig. 71). Heat-treated copper tubing is used throughout for the air brake system. Connections are of the sleeve and nut type, and points requiring flexible couplings are provided with heavy rubber hose furnished with detachable fittings.

b. **Maintenance.**

(1) **TUBING** (fig. 72). Cut new tubing same length as that being replaced. Cut ends square, and smooth up with a file; slide nut and sleeve on each end. Bend tubing to shape of original piece, avoiding sharp bends. Bend tubing $\frac{3}{4}$ inch in diameter on a 3-inch radius; bend tubing $\frac{1}{2}$ inch in diameter on a 4-inch radius.

(2) **HOSE** (fig. 73). Cut new hose same length as hose to be replaced. Screw hose guide into end of hose, and slide spring (if used) and nut on end of hose. Install sleeve on end of hose, position sleeve gasket in fitting body, and screw nut to body. Repeat process to install other end of hose.

c. **Removal.** Unscrew nut from fitting at each end of tubing or hose, and remove all clips holding tubing or hose to vehicle. Pull tubing or hose from vehicle.

SERVICE BRAKE SYSTEM

d. **Installation.** Position tubing or hose on vehicle, and connect nuts to fittings at each end. Install all clips which secure tubing to vehicle.

125. BRAKE PEDAL AND BRAKE CONTROL ROD.

a. **Description (figs. 3 and 28).** The brake pedal is attached to and pivots on the clutch and brake pedal shaft. Pedal is kept in the off position by a retracting spring when not being used. It is attached to foot control valve by brake control rod equipment with a yoke at each end.

b. Removal.

(1) **REMOVE TOEBOARD** (par. 56).

(2) **DETACH PEDAL** (fig. 28). Disengage control rod return spring from brake control rod. Remove cotter pin and clevis pin which secures control rod to brake pedal. Remove the lock ring and flat washer which holds brake pedal on shaft, and pull or pry pedal from shaft.

(3) **REMOVE BRAKE CONTROL ROD.** Remove cotter pin, washer, and clevis pin which attach rod to brake application valve. Snap retracting spring from pull-back clip. Lift rod from vehicle.

c. Installation.

(1) **CONNECT BRAKE CONTROL ROD TO BRAKE APPLICATION VALVE.** Place rod in position with rear yoke holes aligned with hole second from top on brake pedal lever on brake application valve. Install clevis pin, flat washer, and cotter pin. Hook retracting spring to pull-back clip on rod.

(2) **ATTACH PEDAL** (fig. 28). Slide pedal on shaft. Install flat washer and lock ring which hold pedal on shaft. Position control rod yoke to pedal. Install the clevis pin and cotter pin which secure rod to pedal, and connect return spring to spring clip on control rod. Check spring tension, and shorten if necessary to keep pedal in off position.

(3) **INSTALL TOEBOARD** (par. 56).

126. SLACK ADJUSTERS.

a. Description and Tabulated Data.

(1) **DESCRIPTION** (figs. 70 and 74). One slack adjuster fits on the spline on the shaft of each brake cam. These are special levers which connect the brake diaphragm chamber push rods to the brake camshafts.

4- TO 5-TON 4x4 TRACTOR TRUCK (AUTOCAR MODEL U-7144T)

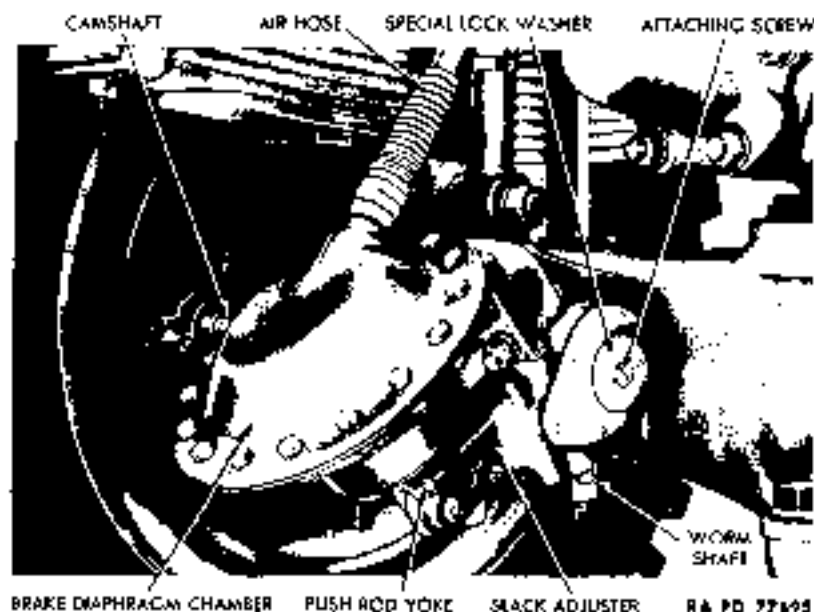

Figure 74 - Rear Brake Diaphragm Chamber and Slack Adjuster

(2) TABULATED DATA.

Manufacturer	Westinghouse
Model:	
Front	220688
Rear:	
LH	217919
RH	217920
Type:	
Front	K
Rear	K

b. Adjustment.

(1) **GENERAL.** Check service brake adjustment with severe service (step 1) below. First adjustment consists of steps (3), (4), and (5) below; subsequent checks and adjustments normally consist of steps (2), (3), (4), and (6), below.

(2) **CHECK BRAKE ADJUSTMENT.** Measure push rod travel. If this exceeds original measurement (step 5) below, adjust brakes (steps (3), (4), and (6) below).

(3) **ADJUST ANCHOR PINS (FRONT BRAKES ONLY)** (fig. 75). Loosen anchor pin lock nut, and remove inspection hole cover on brake

SERVICE BRAKE SYSTEM



RA PD 77987

Figure 75 — Anchor Pin Adjustment

drum. Place 0.008-inch feeler gage through inspection hole under heel of shoe, and turn pin slowly until a barely perceptible drag is felt when gage is moved. Hold anchor pin, and tighten anchor pin lock nut. Recheck clearance, and readjust if necessary. Repeat process to adjust other anchor pin on same wheel. Continue process to adjust anchor pins on other front wheel.

(4) **BUILD UP AIR PRESSURE.** Start engine, and build up pressure to at least 80 pounds. Maintain at least 60 pounds pressure throughout adjustment.

(5) **ADJUST BRAKES AND RECORD PUSH ROD TRAVEL (FIRST ADJUSTMENT ONLY)** (figs. 70 and 74). Jack up each wheel, and turn slack adjuster worm shaft until brake shoes are tight against drum. Back off worm shaft until wheel is free, and insert feeler gage between toe-end of shoe and drum. Turn worm shaft until 0.008- to 0.010-inch clearance is obtained; then apply brakes, and measure brake diaphragm push rod travel. Record measurement for future use in checking (step (2) above) and adjusting (step (6) below) brakes. **NOTE:** *If adjustment is correct, push rod travel will be same for both wheels on an axle. Dimensions will be about $\frac{1}{8}$ inch on front brakes and about $\frac{1}{8}$ inch on rear brakes.*

(6) **ADJUST BRAKES (ALL SUBSEQUENT ADJUSTMENTS)** (figs. 70 and 74). Turn slack adjuster worm shaft until brake diaphragm cham-

4- TO 5-TON 4 x 4 TRACTOR TRUCK (AUTOCAR MODEL U-7144T)

ber push rod travel measures same as in original adjustment (step (5), above). If measurement is not available, adjust as outlined for first adjustment (step (5), above), and record dimensions to facilitate future adjustments.

c. **Removal** (figs. 70 and 74). Use a pointed instrument to mark relative positions of slack adjuster and camshaft. Remove cotter pin and clevis pin which secure push rod to slack adjuster. On front slack adjuster, pry lock ring from brake camshaft. On rear slack adjuster, remove attaching screw and special lock washer. Tap adjuster from shaft.

d. **Installation** (figs. 70 and 74). Position slack adjuster on protruding end of brake camshaft as originally installed, and note marks made before removal. On front of slack adjuster, pry lock ring into position at end of shaft. On rear slack adjuster, install special lock washer and attaching screw. Position push rod yoke to slack adjuster, and install clevis pin and cotter pin which attach rod and adjuster.

127. BRAKE SHOES.

a. Description and Tabulated Data.

(1) **DESCRIPTION** (figs. 76 and 77). Two brake shoes are attached to a backing plate inside each of the four brake drums. Two anchor pins hold adjacent ends of shoes in place. The opposite ends of shoes are pulled together by a brake shoe spring. A cam, located between these ends, pivots when brakes are applied, and pushes ends of shoes apart. This presses lining riveted to shoes against brake drum, creating a braking action. When the brakes are released, the cam pivots back to its original position, and the brake shoe spring draws the shoes toward each other.

(2) **TABULATED DATA.**

Manufacturer Timken

Model:

Front brakes:

Right-hand upper	A2-3822F6
Right-hand lower	A1-3822E5
Left-hand upper	A2-3822E5
Left-hand lower	A1-3822F6

Rear brakes:

Upper	A27-3222B210
Lower	A18-3222B210

Size:

Front	17 1/4 x 4 x 3/4 in.
Rear	17 1/4 x 4 x 3/4 in.

SERVICE BRAKE SYSTEM

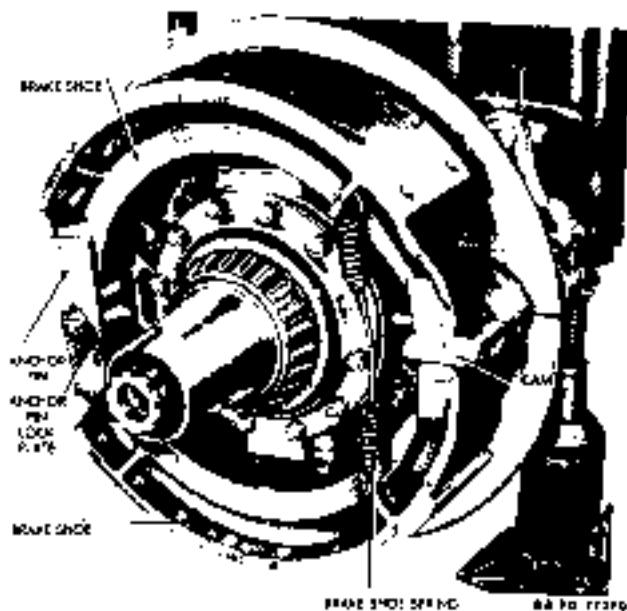

Figure 76 — Front Brake Shoes Installed

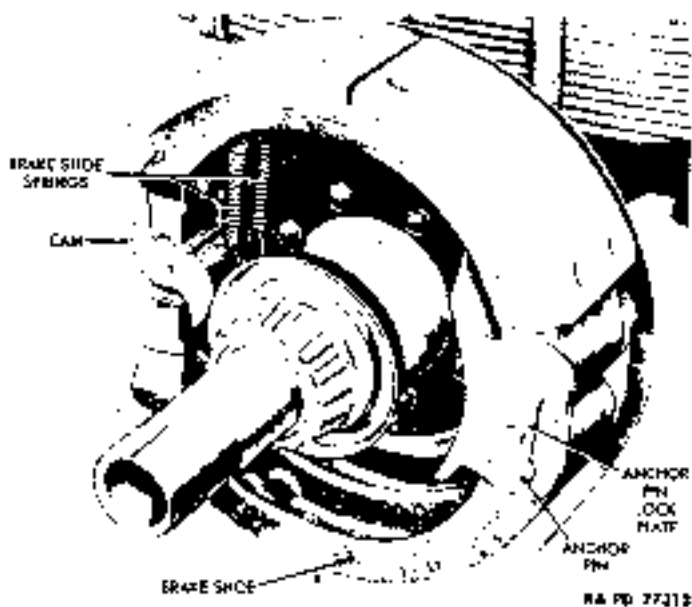

Figure 77 — Rear Brake Shoes Installed

4- TO 5-TON 4 x 4 TRACTOR TRUCK (AUTOCAR MODEL U-7F44T)

b. Removal.

- (1) REMOVE WHEEL AND HUB (pars. 133 and 134).
- (2) LOWER ANCHOR PINS (FRONT WHEELS ONLY) (fig. 75). Loosen anchor pin lock nuts, and turn pin to lowest point.
- (3) REMOVE BRAKE SHOE SPRING (figs. 76 and 77). Use slack adjuster to turn camshaft until shoes are at lowest point on cam. Slide brake shoe spring from holes in shoes. NOTE: Rear wheel brakes have two springs.
- (4) REMOVE ANCHOR PIN LOCK PLATE (figs. 76 and 77). Remove cotter pin and stud nut which hold lock plate on pins, and lift plate from pins.
- (5) REMOVE SHOES (figs. 76 and 77). Pull both shoes from anchor pins.

c. Installation.

- (1) ATTACH SHOES TO ANCHOR PINS (figs. 76 and 77). Position shoes on anchor pins. Position lock plate on pins and shoes, and install stud nut and cotter pin which secures lock plate to pins.
- (2) INSTALL BRAKE SHOE SPRING (figs. 76 and 77). Pull free ends of shoes together, and insert spring and clips through holes in brake shoes. Install two springs on rear wheel brake.
- (3) INSTALL HUB AND WHEEL (pars. 133 and 134).
- (4) ADJUST BRAKES (par. 126).

Section XXVII

PROPELLER SHAFT BRAKE SYSTEM

128. DESCRIPTION.

a. Description (fig. 78). The propeller shaft brake is attached to power train between transfer case and rear axle propeller shaft, and is operated by a lever in the cab. The propeller shaft brake is used chiefly for parking, and when truck is being operated only in case of service brake failure.

129. SHOES.

a. Description and Tabulated Data.

(1) DESCRIPTION (fig. 78). Braking power is obtained by the application of the brake shoes against the brake disks. Two shoes are attached to the front of the brake and two at the back. The shoes are flat and elliptical. The brake lining is attached to each shoe with eight rivets.

PROPELLER SHAFT BRAKE SYSTEM

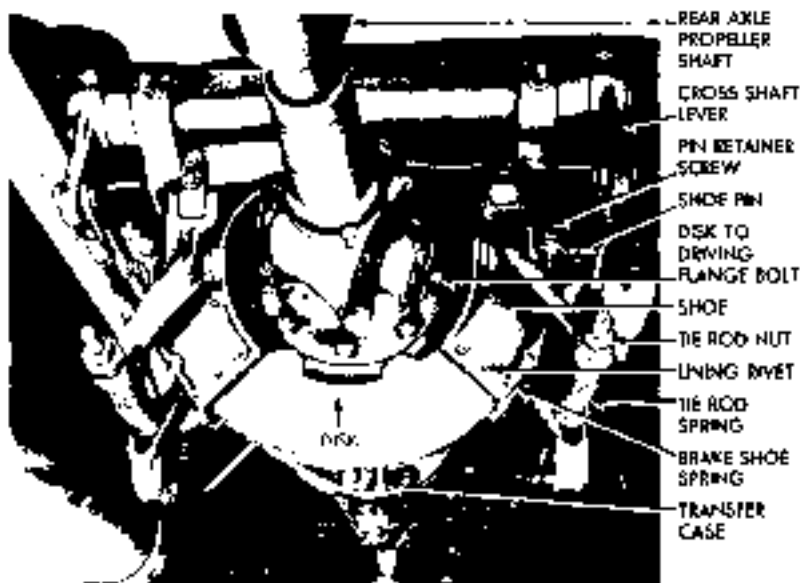

A. REAR VIEW

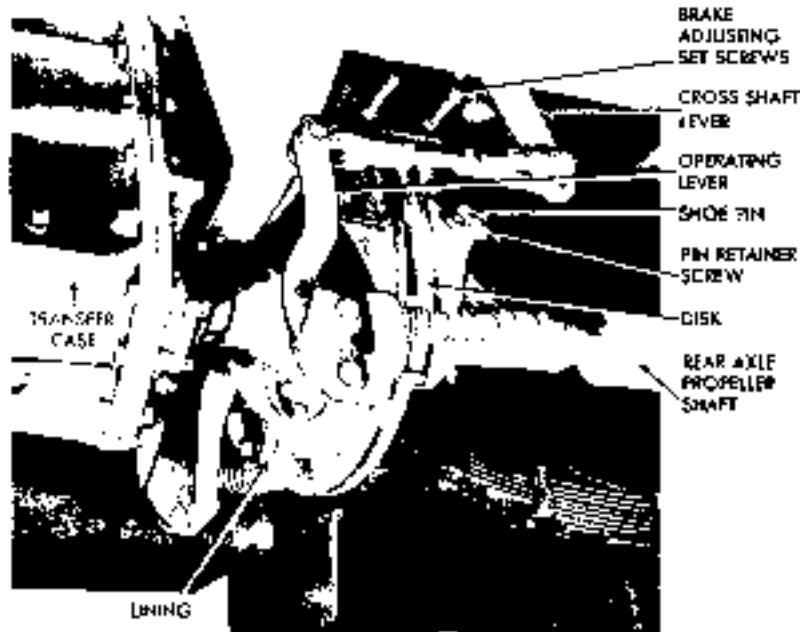

B. LEFT-HAND VIEW

RA PD 77928

Figure 78 — Propeller Shaft Brake

4. TO 5-TON 4x4 TRACTOR TRUCK (AUTOCAR MODEL U-7144T)

(2) TABULATED DATA.

Manufacturer	American Cable
Length	8½ in.
Width	2½ in.

b. **Adjustment.** Release propeller shaft brake lever (fig. 78). Tighten brake shoe adjusting set screws until $\frac{1}{32}$ -inch clearance is obtained between disk and top of shoes on both sides, using feeler gage to measure clearance. Tighten tie rod nut to get $\frac{1}{32}$ -inch clearance between disk and bottom of shoes. Recheck top clearance, and continue procedure until top and bottom clearance is equal. Follow same procedure for pair of shoes on the opposite side. **CAUTION:** Do not shorten propeller shaft brake lever to adjust brake.

c. **Removal** (fig. 78). Loosen the pin retainer screw at back of each shoe. Drive out brake shoe pin which secures each shoe to brake assembly. Remove the four shoes.

d. **Installation** (fig. 78). Position shoes on brake assembly. Install brake shoe pin in each shoe, and secure the four pins with the four pin retainer screws.

130. DISK.

a. Description and Data.

(1) **DESCRIPTION** (fig. 78). The brake disk is located at center of the brake assembly between the four shoes, and consists of two flat metal disks welded together at intervals through bosses. This construction, which provides a semihollow disk, aids cooling and helps to prevent warping. Disk has a lipped hole to which a smaller lipped ring is welded. Driving flanges of transfer case and rear axle propeller shaft are attached to each other through holes in this ring. The disk provides a surface against which brake shoes may act to stop vehicle.

(2) DATA.

Manufacturer	American Cable
Type (2-piece, welded)	8-hole—1,600 series

b. **Removal** (fig. 78). Remove the two brake shoe springs which hold shoes in a vertical position. Remove the eight nuts, lock washers, and bolts which secure brake disk to transfer case and rear axle propeller shaft driving flanges, and remove disk.

c. **Installation** (fig. 78). Position disk between transfer case and rear axle driving flanges, and secure with the eight bolts, lock washers, and nuts. Install the two springs which hold shoes in a vertical position.

PROPELLER SHAFT BRAKE SYSTEM

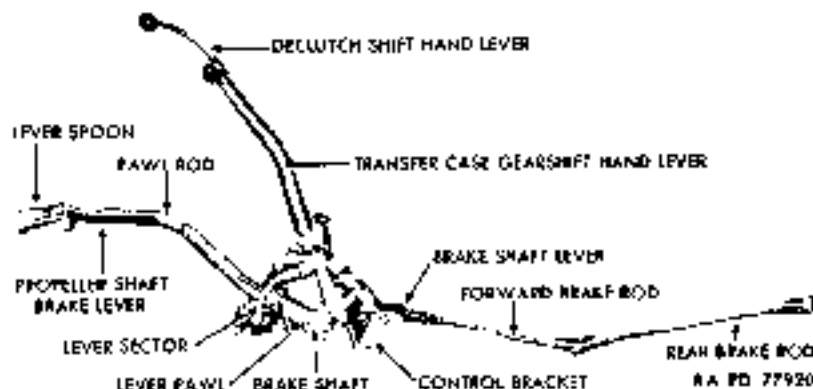

Figure 79 - Propeller Shaft Brake Lever and Linkage

131. LEVER.

a. **Description** (fig. 79). The lever is located in cab beside operator's seat. It consists of a solid bar which pivots on a shaft beneath the floor board, and is held in position by a lever spoon, pawl rod, and lever pawl which engages with a lever sector.

b. **Removal** (fig. 79). Loosen cap screw which clamps brake lever to brake shaft. Remove the two cap screws and lock washers which secure lever sector to control bracket. Remove lever, pawl rod, and lever sector as a unit, and remove Woodruff key from shaft.

c. **Installation** (fig. 79). Insert Woodruff key in brake shaft, and position brake lever on brake shaft and lever sector to control bracket. Install two cap screws and lock washers which secure lever sector to bracket, and tighten cap screw which secures lever to brake shaft.

132. LINKAGE.

a. **Description** (fig. 79). The linkage consists of two brake rods, one located between brake shaft lever and brake transfer lever and one between brake transfer lever and disk brake cross shaft brake lever. Action of the brake lever is transmitted through the brake rods to brake shoes. **CAUTION:** Although linkage is adjustable, it must not be used as a method for adjusting brake.

b. **Removal** (fig. 79). Remove the cotter pin and clevis pin from each end of both rods, and remove rods. Loosen cap screws which secure transfer lever, the four clevis levers, and the shaft lever, and remove levers.

c. **Installation** (fig. 79). Position levers on respective shafts, and tighten cap screws which secures each. Position rods between brake shaft, brake transfer shaft, and brake cross shaft. install clevis pin and cotter pin at both ends of each.

Section XXVIII

WHEELS, HUBS, WHEEL BEARINGS, AND TIRES

133. WHEELS.

a. Description and Tabulated Data.

(1) **DESCRIPTION.** The vehicle is equipped with seven or eight identical wheels, the usual mounting arrangement being dual wheels on the rear and single wheels in front, although wheels may be mounted dually in all positions if desired. Spare wheels are carried at the rear of the cab on a tire carrier mounted to the frame. Wheels mounted dually are installed in a reverse position to each other. Wheels are attached to the hub assembly with 10 inner and 10 outer stud cap nuts. The inner nuts have square heads stamped "R" or "L" indicating right- or left-hand threads to be used in mounting wheels on right-hand or left-hand side of truck. The outer nuts have hex heads and are mounted on inner nuts. These outer nuts are installed even when outer wheel is not used.

(2) **TABULATED DATA.**

Manufacturer	Budd
Size	20 x 8
Type rim	L-M

b. Removal (fig. 80). Set propeller shaft brake and block wheels to prevent vehicle from moving. If wheel is mounted singly, loosen the 10 inner and outer stud cap nuts which secure wheel to hub assembly. Using a suitable lifting device, lift wheel clear of floor, and remove the 10 inner and outer stud cap nuts. If two wheels are mounted dually, remove the outer hex head stud cap nuts first, and remove outer wheel; then remove 10 inner stud cap nuts and remove inner wheel.

c. Installation (fig. 80). Position wheel on hub assembly. If wheel is to be mounted alone, install the 10 inner and outer stud cap nuts. If wheels are to be mounted dually, install the 10 inner stud cap nuts, then mount second wheel and install the 10 outer stud cap nuts. Tighten nuts in opposite positions alternately to ensure proper alignment of wheel and hub. Lower wheel to floor, release brake, and remove blocks from wheels.

134. HUBS AND WHEEL BEARINGS.

a. Description (figs. 81 and 82). The hubs and wheel bearings are attached at each end of the front and rear axle shafts. The hub assembly is installed on bearings, and secured by a bearing nut. Bearings are packed with lubricant to reduce friction. A felt oil seal and

WHEELS, HUBS, WHEEL BEARINGS, AND TIRES

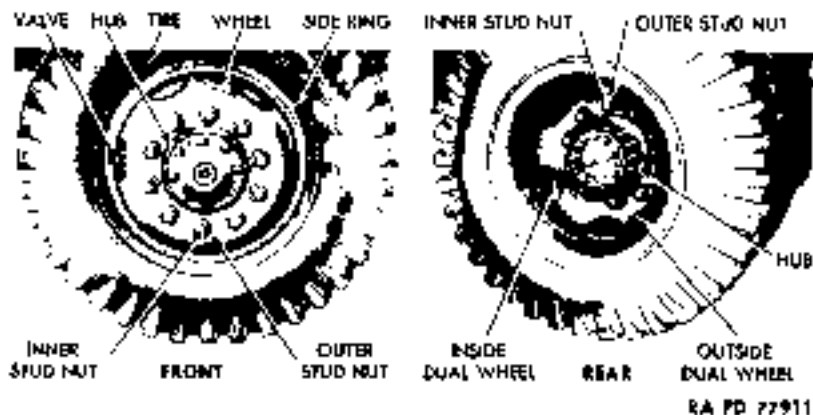

Figure 80 - Front and Rear Wheels

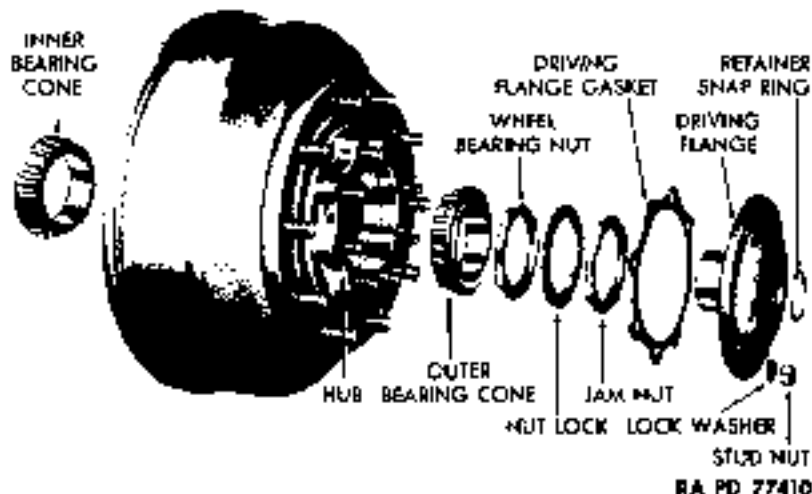
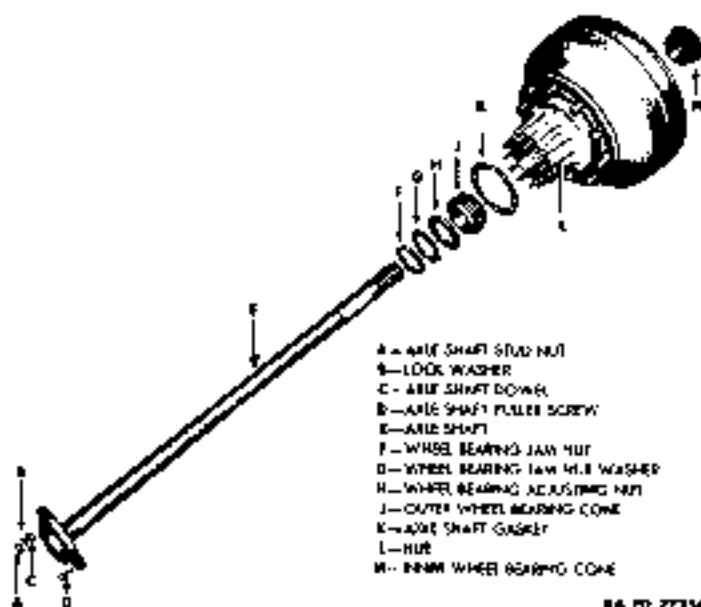

Figure 81 - Front Hub Disassembled

two retainer washers between bearing cone and brake housing assembly prevent lubricant from passing to brake drum.

b. **Adjustment** (figs. 81 and 82). Block wheels to prevent vehicle from moving, and raise wheel from floor with lifting device. Remove retainer snap ring from front hub. Remove the 8 stud nuts and lock washers which secure axle shaft driving flange to hub assembly, and remove flange and gasket. **NOTE:** For rear axle, remove the 12 stud nuts and lock washers, and remove axle shaft. Remove wheel bearing jam nut and the nut lock, which is called jam nut washer on rear axle. Rotate wheel alternately in both directions while tightening wheel bearing nut until wheel binds. Back nut off about one-quarter turn to permit free rotation of wheel without excessive play.

4. TO 5-TON 4x4 TRACTOR TRUCK (AUTOCAR MODEL U-7144T)



DA PD 77334

Figure 82 — Rear Hub and Axle Disassembled

Lift hub with bar to test for excessive play; then tighten nut to eliminate excess but not enough to cause binding. Install lock nut (called jam nut washer on rear axle) and jam nut, and recheck wheel adjustment. Install driving flange if on front wheel, or axle shaft if on rear wheel. Secure with 8 stud nuts and lock washers if front wheel, or 12 stud nuts and lock washers if rear wheel. Lower wheel to floor, and remove blocks.

c. **Removal** (figs. 81 and 82). Remove wheel (par. 133). If front wheel, pry retainer snap ring from driving flange, and remove driving flange jam nut and nut lock. If rear wheel, remove rear axle shaft with attached driving flange as follows: Remove wire seal attached to the 2 axle shaft puller screws. Remove the 12 nuts, lock washers, 3 dowels, and dowel washers which secure flange to hub assembly. Tighten puller screws to start shaft out. Pull shaft and attached flange from axle, and remove wheel bearing nut. Pry wheel outer bearing cone alternately on each side, remove, and pull hub out. Pry off wheel inner bearing cone, and remove felt oil seal and the 2 retainer washers. Remove the 10 stud nuts from inner ends of wheel attaching studs, and lift brake drum from hub. Use a clean cloth to wipe lubricant from all parts.

WHEELS, HUBS, WHEEL BEARINGS, AND TIRES

d. **Installation** (figs. 81 and 82). Position brake drum on hub, and install the 10 stud nuts which attach drum to hub. Install new felt oil seal and 2 retainer washers. Soak felt thoroughly with new engine lubricant, and pack bearings with lubricant (par. 17). Fit wheel inner bearing cone to shaft, taper out, and install hub. Fit wheel outer bearing cone to shaft, taper in, and screw bearing nut on shaft. Finish wheel installation (par. 133). Install rear axle shaft, and attach driving flange as follows: Screw out puller screws to original position. Position shaft in axle, and install the 12 nuts, lock washers, 3 dowels, and dowel washers which secure it to hub assembly. Wire rear axle puller screws. Install wheel (par. 133).

135. TIRES.

a. **Description and Tabulated Data.**

(1) **DESCRIPTION** (fig. 81). Tires are 10-ply, lug-tread, bus-balloon type.

(2) **TABULATED DATA.**

Manufacturer	Lee
Type	Bus-balloon, lug
Size	9.00 x 20

Air Pressure:

Hard-surface road operation	65 lb
Off-road operation	55 lb

b. **Maintenance.** Check tire pressures, wheel alignment, and load distribution frequently. Shift tires periodically to distribute wear. Note recommended pressure for proper inflation.

c. **Removal** (fig. 80). Remove wheel (par. 133). Lay tire flat on floor with valve pointing up, and remove valve core to release air from tire. Remove side ring from wheel as follows: Insert tire iron in groove at end of ring, and pound iron all the way around between ring and wheel. Remove ring, and force tire iron between tire casing and wheel. Pound iron all the way around. **CAUTION: Be careful not to damage valve. Push valve back through opening, remove tire and tube from wheel, and carefully pull flap and tube from tire.**

d. **Installation** (fig. 80). Install tube and flap in tire casing, and install valve core. Partially inflate tube, and check to see that tube is not twisted or buckled and that flap entirely covers exposed side of tube. Position tire on wheel, pull valve through opening, and install side ring. Check valve to see that it does not touch wheel. Inflate tire to proper pressure (subpar. a (2), above). Mount wheel on hub assembly (par. 133).

4. 10 5-TON 4x4 TRACTOR TRUCK (AUTOCAR MODEL U-7144T)

Section XXIX

SPRINGS AND SHOCK ABSORBERS

136. FRONT SPRINGS.

a. **Description (fig. 83).** The front springs are attached to frame side rails and front axle housing. Two spring clips secure center of spring to housing. The rear of spring is attached to frame by a shackle, and the front is attached by a bracket.

b. **Removal (fig. 83).**

(1) **LUBRICATE REMOVAL POINTS.** Set propeller shaft brake. Remove dirt and grease from spring with dry-cleaning solvent, and lubricate spring clips, clip nuts, and spring pins with penetrating oil.

(2) **DISCONNECT SHOCK ABSORBER LINK AT SPRING CLIP PLATE.** Remove jam nut and lock washer which secure link to spring clip plate.

(3) **DISCONNECT SPRING CLIPS.** Remove the four clip nuts and lock washers which secure clips to axle housing.

(4) **REMOVE LUBRICATION FITTINGS.** Screw fittings from bracket and shackle.

(5) **REMOVE DRAW KEYS.** Remove the four nuts and lock washers which secure the two draw keys at each end of spring, and drive out keys.

(6) **REMOVE SPRING CLIPS AND CLIP SEATS.** Raise vehicle with a hoist or jack, to take weight off spring, and to permit weight of axle to disengage clips from axle housings. Remove clips and clip seat.

(7) **REMOVE SPRINGS.** Lower vehicle until weight of spring is supported by axle. Drive spring pins out from inner end, and remove spring.

c. **Installation (fig. 83).**

(1) **INSTALL SPRINGS.** Position spring to shackle and bracket, and insert spring pins from outer end, slotted side down. **NOTE:** Use new parts if old parts show wear.

(2) **INSTALL LUBRICATION FITTINGS.** Screw fittings into bracket and shackle.

(3) **INSTALL DRAW KEYS.** Wedge draw keys against slotted side of pin. Install the four nuts and lock washers which secure draw keys. **NOTE:** Use new draw keys and nuts.

(4) **INSTALL SPRING CLIPS AND SEAT.** Position clip seat and clips to spring and spring clip plate. Secure with the four lock washers and clip nuts.

SPRINGS AND SHOCK ABSORBERS

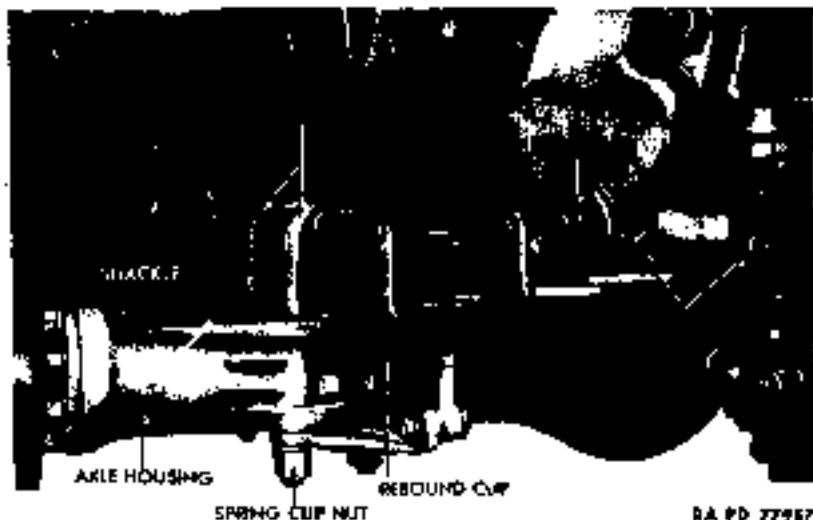

Figure 83 — Front Spring Installed

(5) **CONNECT SHOCK ABSORBER LINK AT SPRING CLIP PLATE.** Position link to spring clip plate, and install jam nut and lock washer which secure link to plate.

(6) **REMOVE LIFTING APPARATUS.** Lower vehicle until full weight rests on springs. Remove lifting apparatus, and release propeller shaft brake.

137. REAR SPRINGS.

a. **Description (fig. 84).** The rear springs are attached to frame side rails by a bracket at the front and a shackle at the rear. The springs are attached to axle housing by two spring clips which clamp center of spring to spring clip plate on housing. Auxiliary springs which help to carry heavy loads are mounted above rear springs, and contact special brackets attached to frame when rear springs flatten out.

b. **Removal (fig. 84).**

(1) **LUBRICATE SPRING ATTACHING PARTS.** Clean spring, and lubricate clip nuts and spring pins with penetrating oil.

(2) **DISCONNECT SHOCK ABSORBER** (par. 138).

(3) **DISCONNECT SPRING CLIPS.** Remove the four clip nuts and lock washers which secure clips to axle housing. Lift rear end of truck until clips are pulled free from axle housing, and remove clips and clip seats.

4- TO 5-TON 4 x 4 TRACTOR TRUCK (AUTOCAR MODEL U-7144T)

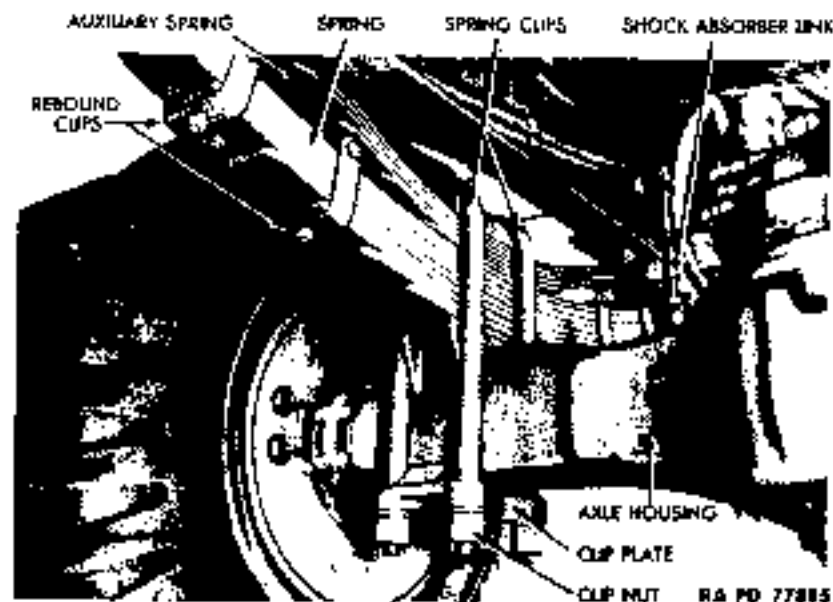

Figure 84 - Rear Spring Installed

(4) **REMOVE LUBRICATION FITTINGS.** Unscrew fittings from outer side at each end of spring.

(5) **REMOVE DRAW KEYS** (fig. 83). Remove the four nuts and lock washers which secure the two draw keys at each end of spring, and drive out keys.

(6) **REMOVE SPRING.** Drive spring pins out from inner side of spring, and remove spring.

c. **Installation** (fig. 84).

(1) **INSTALL SPRING.** Position spring between shackle and bracket, and insert spring pins, slotted side down, from outer side of spring at each end. **NOTE:** Use new parts if old parts show wear.

(2) **INSTALL DRAW KEYS.** Wedge draw keys at each end against slotted side of pin, and secure with the four nuts and lock washers. **NOTE:** Use new draw keys and nuts.

(3) **INSTALL LUBRICATION FITTINGS.** Screw fittings into outer side at each end of spring.

(4) **INSTALL SPRING CLIPS.** Position clip seat and clips to spring and clip plate on axle housing, and secure with the four lock washers and nuts.

(5) **CONNECT SHOCK ABSORBER** (par. 138).

SPRINGS AND SHOCK ABSORBERS

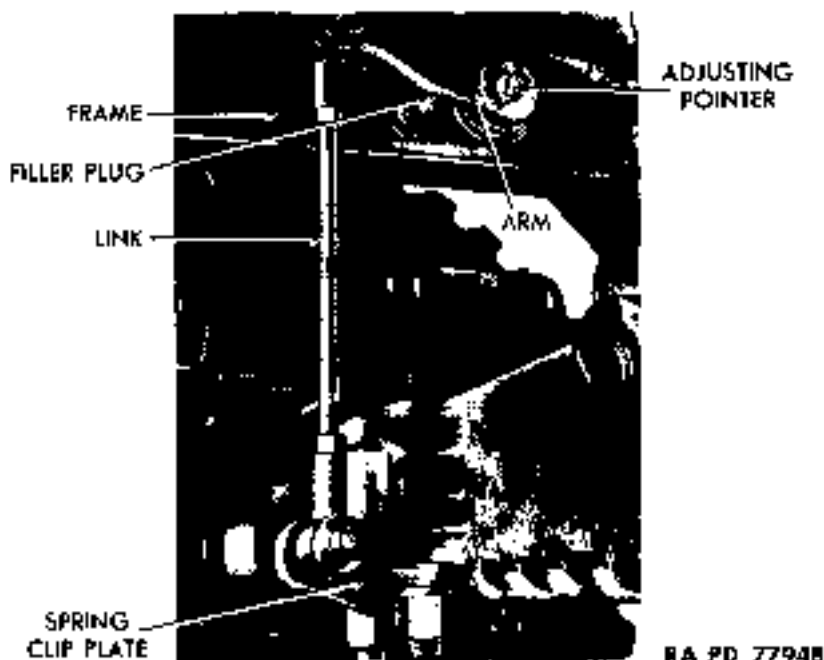

Figure 85 - Front Shock Absorber Installed

(6) **REMOVE LISTING APPARATUS.** Lower vehicle so that full weight rests on springs. Remove apparatus. Release propeller shaft brake.

138. SHOCK ABSORBERS.

a. Description and Tabulated Data.

(1) **DESCRIPTION** (figs. 85 and 86). Four shock absorbers are attached to inside of frame side rails. The front shock absorbers are in front of front axle, and the rear shock absorbers are behind rear axle. Shock absorbers are a double acting, oscillating-valve type. They are used to control spring action, and offer more resistance to spring recoil than to spring compression.

(2) **TABULATED DATA.**

Manufacturer	Houdaille
Model:		
Front	BBCLT
Rear	BBH

b. Maintenance and Adjustment.

(1) **MAINTENANCE** (figs. 85 and 86). Check fluid level and refill, if necessary. To fill shock absorber, observe the following procedures:

4- TO 5-TON 4 x 4 TRACTOR TRUCK (AUTOCAR MODEL U-71447)

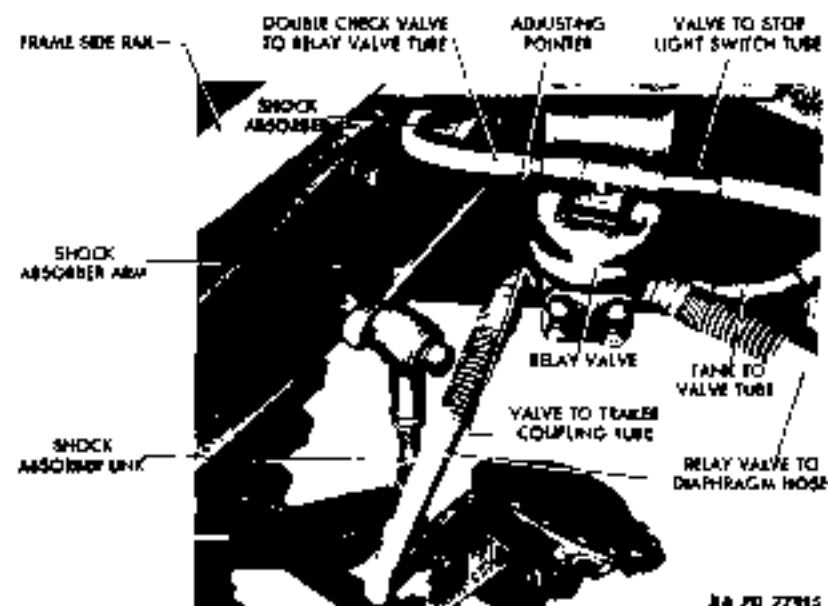

Figure 86 - Rear Shock Absorber Installed

Disconnect shock absorber link (subpar. c, below). Clean dirt and grease from around filler plug, and remove plug. Fill reservoir to bottom of filler hole with shock absorber fluid. Work shock absorber arm up and down several times to expel air from system, and add more fluid if necessary. When air is removed and shock absorber is properly filled, install filler plug and connect shock absorber link.

(2) **ADJUSTMENT** (figs. 85 and 86). No adjustment of links is required. Shock absorber arm tension is increased or decreased by turning an adjusting pointer outside the shock absorber. Turn pointer counterclockwise to increase resistance, or clockwise to decrease resistance. Make adjustment one mark or $\frac{1}{16}$ inch at a time. **NOTE:** Full range of adjustment is one-half turn or between the two stops. Do not turn pointer beyond these stops.

c. **Removal** (figs. 85 and 86).

(1) **FRONT SHOCK ABSORBER.** Remove the jam nut and lock washer which secure link to spring clip plate, and disengage link from plate. Remove the two nuts, lock washers, and bolts which secure shock absorber to frame. Remove shock absorber, arm, and link as unit.

(2) **REAR SHOCK ABSORBER.** Remove the two nuts and washers from bolt securing link to rear spring shank, and remove bolt. Remove

STEERING GEAR

as a unit, the two nuts, lock washers, and bolts which secure shock absorber to frame.

d. Installation (figs. 85 and 86).

(1) **FRONT SHOCK ABSORBER.** Position shock absorber to frame, and secure with two bolts, lock washers, and nuts. Install link to spring clip plate, and secure with lock washer and jam nut.

(2) **REAR SHOCK ABSORBER.** Position shock absorber to frame, and secure with two bolts, lock washers, and nuts. Install link to rear spring shim, install bolt, and secure with two nuts and lock washers.

Section XXX

STEERING GEAR

139. DESCRIPTION AND TABULATED DATA.

a. **Description (figs. 87 and 89).** The steering gear is attached to the frame side rail at front left-hand side of vehicle, extending from the steering arm attached to left front wheel assembly through the steering gear housing to the steering wheel in the cab. The gear is the roller-mounted twin-lever type. The turning action of the steering wheel is relayed to the steering arm through a cam engaged to two studs mounted in tapered roller bearings on the lever shaft.

b. Tabulated Data.

Manufacturer	Ross
Model	T71
Type	Cam and lever

140. MAINTENANCE AND ADJUSTMENT.

a. **Maintenance (figs. 87 and 89).** Check the drag link regularly for excess slack or end play. Check steering jacket tube assembly for end play by attempting to move it back and forth on its axis. Keep steering gear housing filled with proper lubricant.

b. **Adjustment.** Major adjustments of steering gear concerns drag link end play, lever shaft end play, and steering gear jacket tube vertical end play.

(1) **ADJUST JACKET TUBE VERTICAL END PLAY (fig. 87).** Disconnect steering arm from drag link (par. 143). Loosen dash bracket clamp to prevent drag from hindering adjustment. Loosen side cover adjusting screw lock nut and side cover adjusting screw at right-hand side of housing. Remove the four nuts and lock washers which secure upper cover plate to housing. Slide cover plate up, and remove one of

4. TO 5-TON 4x4 TRACTOR TRUCK (AUTOCAR MODEL U-7144T)

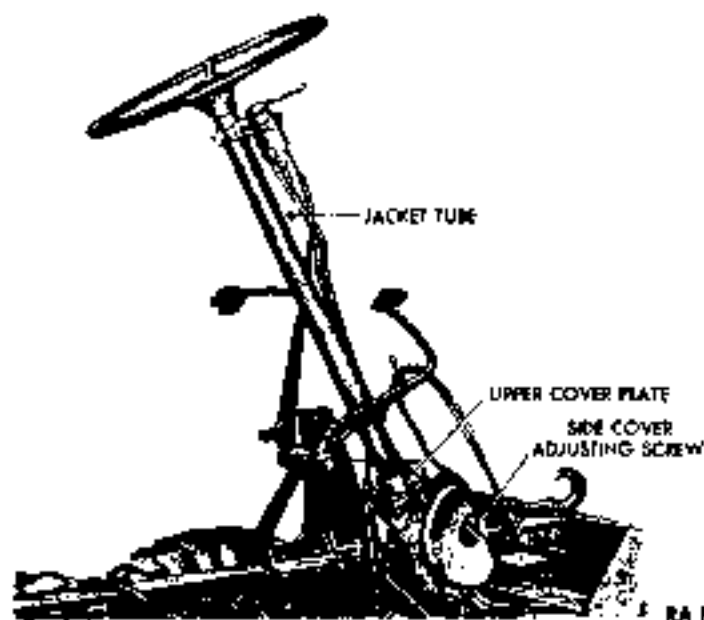

Figure 87 — Steering Gear Installed

the shims between cover plate and housing. Replace cover plate, and secure with the four lock washers and nuts. Test adjustment. If adjustment is not right, remove or replace shims as necessary to produce drag of 2 pounds on steering wheel rim. Adjust lever shaft end play (step (2) below).

(2) **ADJUST LEVER SHAFT END PLAY** (fig. 87). Turn wheels straight ahead, placing studs in cam groove at midposition of travel. Tighten side cover adjusting screw until a very slight drag is felt through the midposition. Tighten adjusting screw lock nut, and recheck drag after lock nut is tight.

(3) **ADJUST DRAG LINK END PLAY** (fig. 89). Remove the nut, lock washer, and bolt from adjusting plug at the end of drag link where adjustment is to be made. Screw in adjusting plug until slack is removed. Do not tighten more than necessary. Install bolt, lock washer, and nut which keep adjusting plug from turning.

141. STEERING WHEEL (fig. 88).

a. **Removal.** Remove horn button assembly (par. 166). Remove wheel nut, and lift steering wheel from jacket tube. Remove spring and spring seat from jacket tube ball bearing assembly.

b. **Installation.** Position spring and spring seat in jacket tube ball

STEERING GEAR

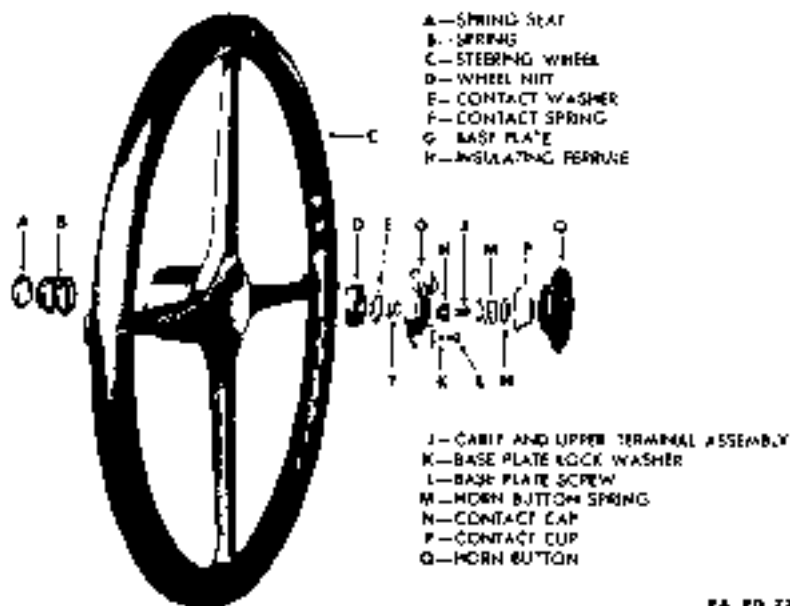

Figure 88 — Steering Wheel Assembly Disassembled

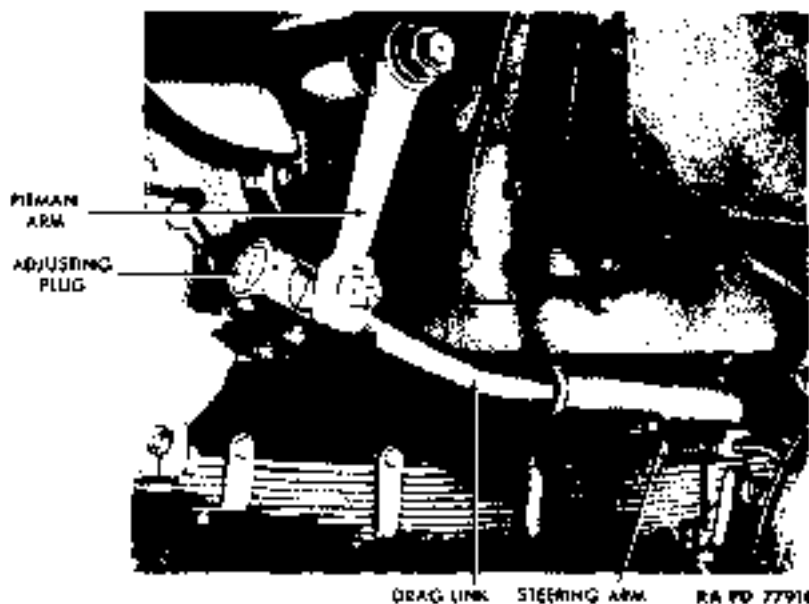

Figure 89 — Drag Link Installed

4- TO 5-TON 4 x 4 TRACTOR TRUCK (AUTOCAR MODEL U-7144T)

bearing assembly. Set steering wheel on jacket tube, and screw on steering wheel nut. Install horn button assembly (par. 155).

142. DRAG LINK (fig. 89).

a. **Removal.** Remove the cotter pin and nut which secure drag link to steering arm ball at each end, and remove drag link.

b. **Installation.** Position drag link to steering arm ball at each end. Secure with the two nuts and cotter pins, and check for proper adjustment (par. 140).

143. PITMAN ARM (fig. 89).

a. **Removal.** Remove cotter pin, nut, and lock washer which secures arm to tapered spline end of lever shaft. Tap arm from shaft, and disconnect arm from drag link.

b. **Installation.** Tap steering arm on tapered spline end of lever shaft, and secure with lock washer, nut, and cotter pin. Attach drag link to arm.

Section XXXI

BODY AND FRAME

144. DESCRIPTION (figs. 1 and 2).

a. The cab is mounted over the engine, access to which is obtained by removing the engine hood inside the cab and the fender skirts beneath the front fenders. Removable fabric top, rear curtain, and side curtains completely enclose the cab interior. Other parts include: an adjustable windshield, two windshield wipers, doors, rear vision mirrors, grab handles, fenders, and steps. The frame is riveted and welded construction. Frame attachments include bumper, towing hooks, and pintle hook.

145. WINDSHIELD WIPERS.

a. Description and Tabulated Data.

(1) **DESCRIPTION** (fig. 90). A wiper is mounted at top center of each half of the divided windshield with an air-operated motor for each wiper supported by a bracket attached to the inside top of the windshield frame. The power of the motor is transmitted through a shaft extending from the motor to a wiper arm with movable blade attached outside the windshield. The operation of the wipers is controlled by two valves attached to the instrument panel (fig. 3).

BODY AND FRAME

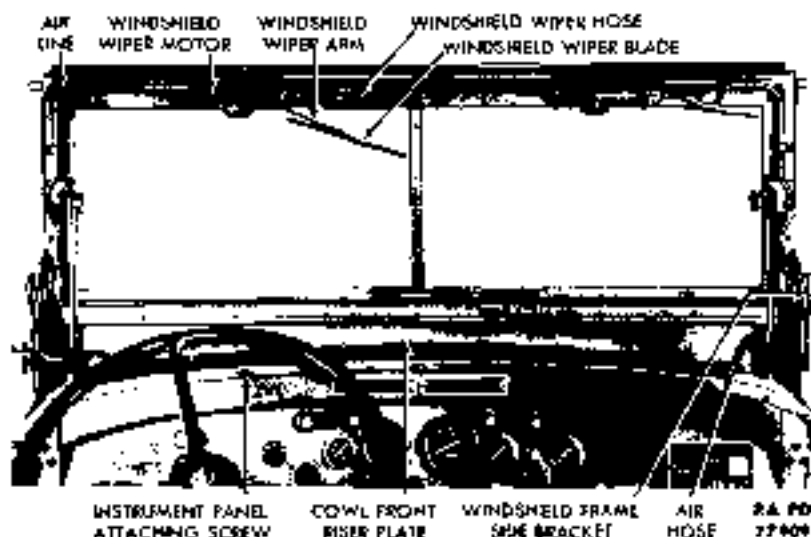

Figure 90 - Windshield Installed

(2) TABULATED DATA.

Manufacturer	Trico-Folberth
Number of assemblies	2

b. **Maintenance** (fig. 90). Check air lines for plugged line or fittings, kinked hose or tubing, and leaks. Tighten all connections. Lubricate seal felts around shaft with light engine oil regularly. If wiper fails to operate after line has been thoroughly checked, replace motor assembly. Replace worn wiper blades.

c. **Removal** (fig. 90). Disconnect hose from air line. Remove the nut which secures wiper arm to motor shaft, and remove arm and blade as a unit. Remove the two screws and lock washers which secure motor bracket to windshield frame, and remove motor assembly.

d. **Installation** (fig. 90). Position wiper motor assembly on windshield frame, and secure with the two screws and lock washers. Position wiper arm to motor shaft, and secure with lock washer and nut. Connect hose to tube.

146. WINDSHIELD ASSEMBLY.

a. **Description** (fig. 90). The windshield is attached at the top rear of the cowl assembly with manually operated quadrant arms controlling opening of the windshield from the bottom outward.

b. **Removal** (fig. 90). Disconnect air hose front tube at each side of windshield. Remove the five hex cap screws and lock washers which

4. TO 5-TON 4x4 TRACTOR TRUCK (AUTOCAR MODEL U-71A4T)

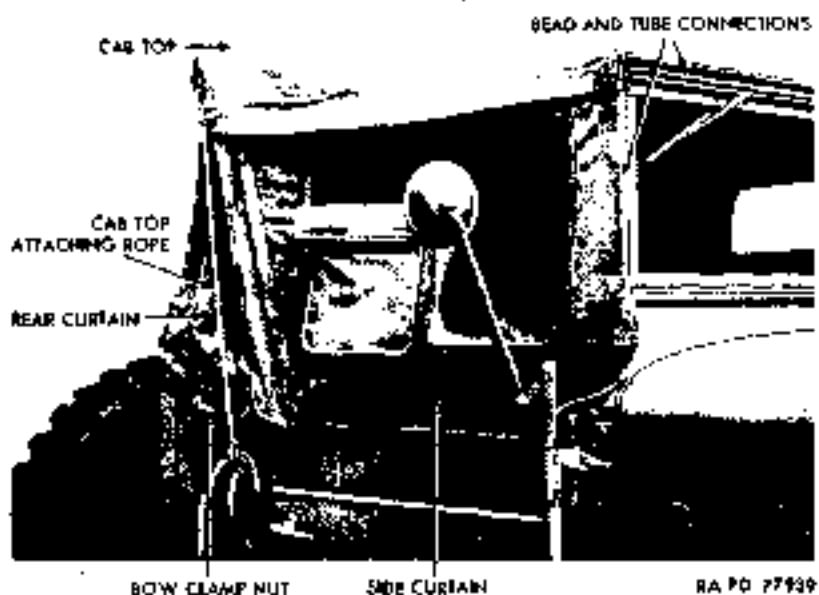

Figure 91 — Exterior of Installed Cab Top

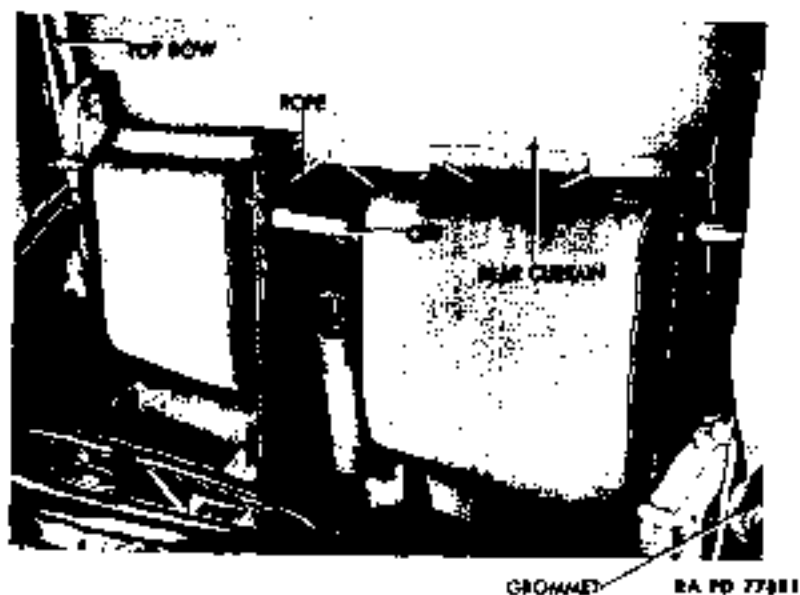

Figure 92 — Interior of Installed Cab Top

BODY AND FRAME

secure each of the windshield frame side brackets to cowl. Remove the two bolts, nuts, and lock washers which secure each bracket to cowl front riser plate; then remove windshield assembly.

n. **Installation** (fig. 90). Position windshield assembly on cowl. Secure brackets to cowl with the 10 hex cap screws and lock washers. Install the 2 bolts, lock washers, and nuts which secure brackets to cowl front riser plate.

147. CAB TOP.

a. **Description** (figs. 91 and 92). The cab top includes: a fabric top attached between windshield frame and top bow, fabric rear curtain attached between top bow and rear top of cab, and a fabric side curtain with window attached between windshield frame and rear curtain on each side. The top and sides are attached to windshield frame through a bead and tube connections. Ropes secure top and rear curtain to top bow and rear of cab.

b. **Maintenance**. Keep curtains and top securely fastened when installed and stowed safely out of way when removed. Do not fold top or curtains when wet.

c. **Removal** (figs. 91 and 92). Untie cab top attaching rope. Disengage top from the grommet which secures it to windshield frame on each side, and pull top over windshield assembly. Slide bead at front of top from tube at top of windshield, and remove top. Disengage side curtains from the four grommets which secure them to windshield frame, cowl, and door on each side. Slide curtain support rod from bracket on door, and pull rod from curtain. Slide bead at front edge of curtain from tube at side of windshield frame, and remove curtain. Disengage rear curtain from grommet which secures it to cab on each side. Loosen and unhook rope which secures curtain to rear top of cab. Loosen clamp nut which secures top bow to cab on each side. Remove cotter pin and flat washer at bottom of top bow on each side, and slide bow from bracket. Remove rear curtain and top bow as a unit.

d. **Installation** (figs. 91 and 92). Position top bow with rear curtain attached in bracket on cab. Install flat washer and cotter pin which hold bow in bracket. Tighten clamp nuts. Engage rope threaded through grommets in curtain to hooks on cab, and tighten and secure rope. Fasten curtain to grommet on each side of cab. Slide bead at front of side curtain through tube on windshield frame, slide support rod in curtain, and position rod end in door bracket. Fasten curtain to the four grommets which secure it to door, cowl, and windshield frame. Slide bead at front of top through tube on windshield frame. Fasten grommet on each side to windshield frame, and pull top over top bow. Pull rope tight, and tie to grab handle on each side.

4. TO 5-TON 4 x 4 TRACTOR TRUCK (AUTOCAR MODEL U-7144T)

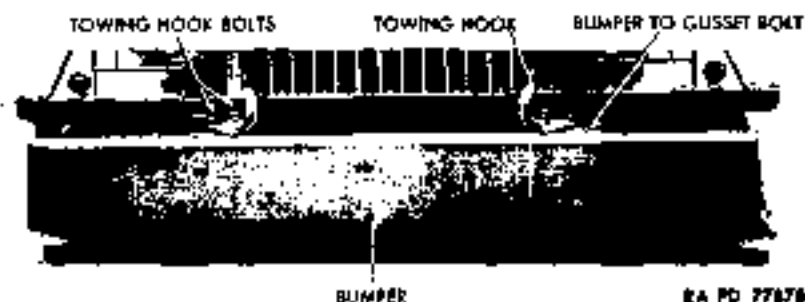

Figure 93 — Bumper and Towing Hooks Installed

148. BUMPER.

a. **Description** (fig. 93). The bumper is attached to frame side rails at front of the vehicle for protection of vehicle, and for attaching a towing or lifting device to truck. A hole in center permits use of the starting crank through the bumper.

b. **Removal.** Remove the two nuts, bolts, and four lock washers which secure the emergency towing hose assembly bracket to bumper on each side. Pull brackets free from bumper. Remove the 5 bolts, nuts, and 10 lock washers which secure bumper to bumper gussets on each side, and remove bumper.

c. **Installation.** Position bumper on frame brackets, and install the 5 bolts, nuts, and 10 lock washers which secure it to bumper gussets on each side. Attach emergency towing hose assembly bracket to bumper on each side, and secure with the 2 bolts, nuts, and 4 lock washers.

149. TOWING HOOKS.

a. **Description** (fig. 93). Two towing hooks are attached to bumper gussets at front of vehicle for attaching towing cable.

b. **Removal.** Remove the two bolts, nuts, spacers, four lock washers, and one toothed lock washer which secure hooks to bumper gusset on each side. Remove hooks.

c. **Installation.** Position hooks on bumper gussets. Install the two bolts, nuts, spacers, four lock washers, and one toothed lock washer which secure hook to gusset on each side.

150. PINTLE HOOK.

a. **Description** (fig. 94). The pintle hook is attached to two bearing plates mounted on two frame crossmembers at the rear of the truck. The top of the hook operates as a lever which can be pushed

BODY AND FRAME

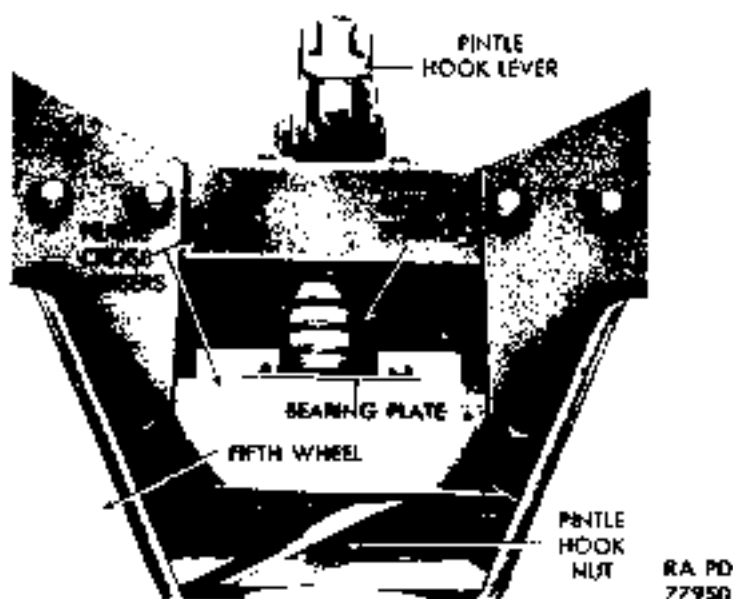

Figure 94 — Pintle Hook Installed

back to provide a 2-inch opening, and can be locked in either open or closed position. A heavy coil spring is mounted on the pintle shaft between the bearing plates to reduce shocks in stopping and starting. The pintle hook is used for towing.

b. **Maintenance.** If the pintle hook latch pin or the latch pin lock screw become worn it is possible for the pintle latch to open and release the lunette of the towed load. To avoid this, examine the pintle hook latch pin and latch pin lock screw. If worn, replace the pin with a steel bolt $3\frac{1}{4}$ inches long x $\frac{7}{8}$ inch in diameter. Two $1\frac{1}{2}$ -inch square tapered washers, one $\frac{3}{4}$ -inch nut, and a cotter pin are also required. When installing bolt and tightening nut be sure to clamp the pintle latch and lock the nut with the cotter pin. Discard the latch pin lock screw and plug the hole with a wood plug.

c. **Removal.** Remove cotter pin, pintle hook, nut, and flat washer which secure pintle assembly to frame crossmembers. Pull assembly from crossmembers.

d. **Installation.** Position pintle assembly on frame crossmembers. Install spring on shaft between bearing plates, and secure with the flat washer, nut, and cotter pin.

4- TO 5-TON 4x4 TRACTOR TRUCK (AUTOCAR MODEL U-7144T)

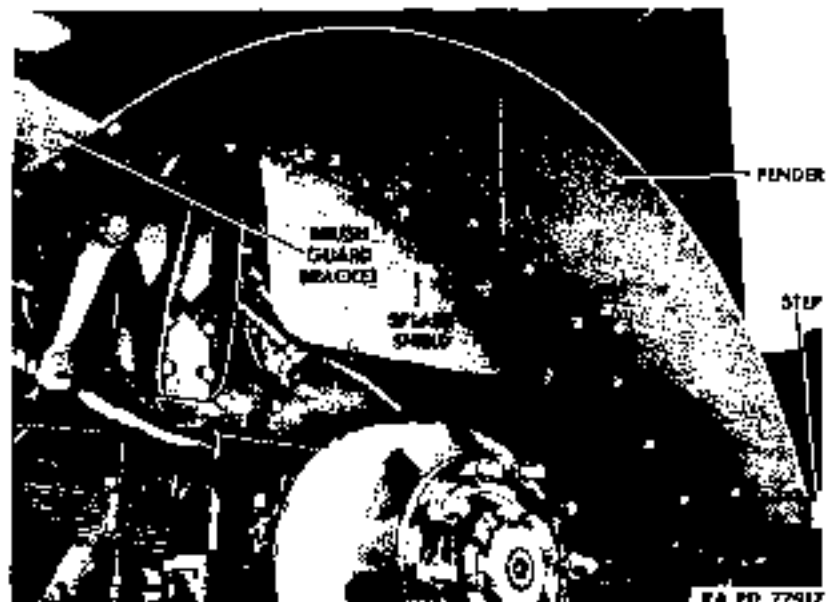

Figure 95 - Fender Installed

151. FENDERS.

a. **Description** (fig. 95). The front fenders are attached to cowl and cab above front wheels, to steps at rear, and to brush guard bracket at front. Rear quarter fenders are attached to fender cross supports in front of rear wheels.

b. **Maintenance.** Keep painted surfaces clean, and repaint when paint wears off. Keep mounting bolts and nuts tight at all times to prevent vibration.

c. **Removal.** Remove the 4 wing screws, lock washers, and flat washers which attach splash shield to fender, and pull shield free of fender. Remove the 3 bolts, nuts, and lock washers which secure front fender to step. Remove the 4 bolts, nuts, and lock washers which secure fender to brush guard bracket. Remove the 12 bolts, nuts, flat washers, and 24 lock washers which secure fender to cowl and cab, and remove front fender. Remove the 7 bolts, nuts, and 14 lock washers which secure rear quarter fender to cross support, and remove fender.

d. **Installation.** Position fender to cab and cowl, and attach to steps with the 3 bolts, nuts, and lock washers. Attach to brush guard bracket with the 4 bolts, nuts, and lock washers. Install the 12 bolts, nuts, and 24 lock washers which secure fender to cab and

BATTERY AND LIGHTING SYSTEM

cowl. Position splash shield on fender. Install the 4 lock washers, flat washers, and wing nuts which attach shield to fender. Position rear quarter fender on cross support, and secure with the 7 bolts, nuts, and 14 lock washers.

152. STEPS.

a. **Description.** A step is attached on each side to fender, cab, and an angle bracket. The steps facilitate mounting and demounting from vehicle.

b. **Maintenance.** Keep painted surfaces clean, and repaint when paint wears off. Keep mounting bolts and nuts tight at all times to prevent vibration.

c. **Removal.** Remove the six bolts, lock washers, and nuts securing each step to front fender and to cab. Remove steps and angle bracket as a unit.

d. **Installation.** Position steps and bracket to fenders and cab, and secure with the six bolts, nuts, and lock washers.

Section XXXII

BATTERY AND LIGHTING SYSTEM

153. DESCRIPTION (fig. 9b).

a. The battery and lighting system is directly connected to the ignition system and to the starting and generating systems. Current to operate lights and horns is provided by two 19-plate, 6-volt batteries connected in parallel. All lights except the blackout driving light and the instrument panel lights are controlled by the four-position light switch on the instrument panel (fig. 104).

154. BATTERIES.

a. **Description.** The two 19-plate 6-volt batteries are mounted in a steel battery box in the cab beneath the operator's seat. Easy access to batteries is provided by raising the hinged seat cover. Hold-down frames which fit around the top edges of batteries and are clamped to the box, hold the batteries in position.

(1) TABULATED DATA.

Manufacturer	Exide
Model	XH-194
Specific gravity:	
Full charge	1.275 — 1.285
Recharge	1.200

BATTERY AND LIGHTING SYSTEM



Figure 97 - Batteries Installed

b. Maintenance.

(1) **TEST ELECTROLYTE.** Use a hydrometer to test specific gravity. A reading of 1.275 or more in each cell indicates that battery is fully charged, while a reading of less than 1.225 in hot weather and 1.250 in cold weather indicates that battery needs charging. If difference of 20 points or more between cells is found, notify higher authority.

(2) **TEST FOR HIGH RESISTANCE.** If cranking motor action is slow and lights are brighter with increased engine speed, check for high resistance in battery circuit with a low reading voltmeter. Check voltage drop between grounded battery terminal and frame. Position voltmeter on grounded post and on frame, and with ignition switch "OFF," crank engine with cranking motor. A reading in excess of 1/10 volt indicates high resistance in this circuit. Use same method to check voltage drop between negative post of left-hand battery and positive post of right-hand battery, negative post of right-hand battery, and copper connector between cranking motor solenoid switch and cranking motor. High resistance in circuit is indicated by a reading greater than 1/10 volt.

(3) **REMOVE HIGH RESISTANCE IN BATTERY CIRCUIT.** Disengage cables in faulty circuit, clean connections, and replace cables that are worn or damaged. If high resistance still exists, replace series-parallel cranking motor switch (par. 91) and/or cranking motor solenoid switch (par. 90).

4. TO 5-TON 4 x 4 TRACTOR TRUCK (AUTOCAR MODEL U-7144T)

(4) **ADD WATER TO BATTERY** (fig. 97). Remove vent caps from battery and check level of electrolyte in cells. If level is less than $\frac{3}{8}$ inch above separators, add pure distilled water.

c. **Removal** (fig. 97). Remove cushion, and raise operator's seat cover. Loosen nuts on battery terminal clamps, and pry clamps from terminal posts. Remove the two battery hold-down frame stud nuts and lock washers. Lift off battery hold-down frame, and lift batteries from vehicle.

d. **Installation** (fig. 97). Position batteries in battery box so the positive posts are at rear, and place battery hold-down frame on batteries. Secure with the two stud nuts and lock washers, drawing nuts up snug but not tight. In installing left-hand battery, connect cable from "A" terminal of cranking motor switch to negative post; connect ground cable to positive post. In installing right-hand battery, connect cable from cranking motor solenoid switch to negative post; connect cable from "B+" terminal of cranking motor switch to positive post. Grease exposed metal parts of cable terminal and post after connection is made. Lower cover of operator's seat, and install cushion. Check installation of batteries, and start engine with cranking motor to test starting of engine and charging rate as shown by ammeter.

155. LIGHT SWITCH.

a. Description and Tabulated Data.

(1) **DESCRIPTION** (figs. 3 and 104). The push-pull type light switch, located on the instrument panel, controls all lights except the blackout driving light. The second position of the switch turns on all the blackout lights, and it is locked there by a spring plunger lock, which must be pushed in before the switch can be pulled out to another position. The third position of the switch turns on the service lights. The fourth position permits operation of the service stop light only.

(2) TABULATED DATA.

Manufacturer Delco-Remy
Type Push-pull

b. **Removal** (figs. 3 and 104). Disconnect batteries (par. 154), and disconnect all wires from switch. **CAUTION:** Tag wires to insure correct installation. Loosen set screw on knob, and screw knob from switch shaft. Loosen set screw on under side of push button housing, and pull housing from switch shaft. Remove nut and washer from switch collar, and pull switch from reverse side of instrument panel.

c. **Installation** (figs. 3 and 104). Position switch to instrument panel, and secure with washer and nut. Depress button at side of

BATTERY AND LIGHTING SYSTEM

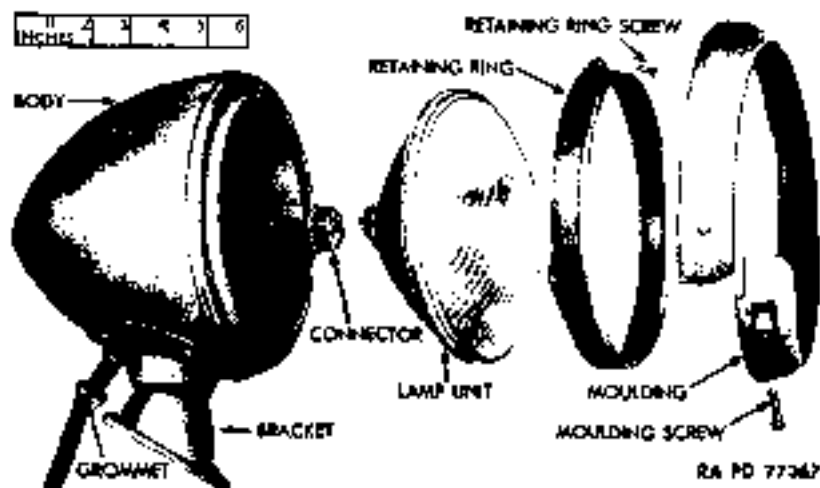

Figure 98 — Headlight Disassembled

push-button housing, slide into position on switch shaft, and tighten set screw on under side of housing. Screw knob on shaft, and tighten knob set screw. Connect wires to switch terminals in positions indicated by tags. If tags were not used, connect wires as follows: green wire from junction block to "S" terminal; green-yellow wire from junction block to "BS" terminal; black wire from junction block, red wire from instrument light switch, and orange-black wire from headlights to "HT" terminal; orange wire from blackout lights, blue-red wire from junction block, and black-white wire from blackout driving light switch to "HMT" terminal; red No. 10 wire from ammeter to "E" terminal; yellow-black wire from terminal block to "SW" terminal; black-yellow wire from terminal block to "TT" terminal; blue wire and green-red wire from junction block to "SS" terminal. Test correct installation of wires by operating switch in each of its four positions, and noting order in which lights operate.

156. HEADLIGHTS.

a. Description and Tabulated Data.

(1) DESCRIPTION (fig. 98). Two sealed-beam headlights are mounted outside the cowl above the front fenders. The unit, consisting of lens, lamp, and reflector, is held in place by a retaining ring covered by moulding.

(2) TABULATED DATA.

Type	Sealed-beam
Low beam	35 watts
High beam	45 watts

4. TO 5-TON 4 x 4 TRACTOR TRUCK (AUTOCAR MODEL U-71447)

b. Maintenance.

(1) **REPLACE LAMP.** Loosen molding screw, and pull molding from body. Remove the three retaining ring screws, and lift retaining ring from body. Carefully pull sealed beam lamp-unit several inches out, pull connector from prongs on unit, and remove lamp-unit. Position new lamp-unit to light, push connector on prongs, and adjust unit to position in light. Position retaining ring onto body, and secure with the three retaining ring screws. Push molding onto body, and tighten molding screw.

c. Removal.

(1) **REMOVE SPLASH SHIELD EXTENSION.** Remove the two wing nuts, flat washers, and lock washers which secure extension to cowl, and remove extension.

(2) **DISCONNECT WIRES.** Remove friction tape from wires where they join at frame side rail behind bumper. Remove the three bolts and nuts which join wires together.

(3) **DETACH LIGHT.** Remove the two nuts, bolts, and four lock washers which secure headlight bracket to cowl. Pull ground wire free, lift light from cowl, and pull wires free.

d. Installation.

(1) **ATTACH LIGHT.** Position headlight bracket to cowl, and secure with the two bolts, nuts, and four lock washers. **NOTE:** Attach ground wire to lower bolt inside cowl.

(2) **INSTALL WIRES.** Push wires through cowl opening behind light. Pull wires from underneath into position to join wires of opposite headlight. Connect wires from light to wires of matching color projecting from harness. Secure wires together with the three bolts and nuts, and insulate each from each other with friction tape. Wrap the three wires together with friction tape.

(3) **TEST INSTALLATION.** Turn lights on, and operate foot dimmer switch to check proper operation.

(4) **INSTALL SPLASH SHIELD EXTENSION.** Position extension to cowl, and secure with the two wing nuts, flat washers, and lock washers.

157. BLACKOUT DRIVING LIGHT.

a. Description and Tabulated Data.

(1) **DESCRIPTION** (fig. 99). The blackout driving light, attached to cowl above left headlight, is used while the vehicle is being operated during blackouts. The lens is opaqued except for a small portion at the top which is covered with a shield. The lamp, reflector, lens and shield are one sealed beam lamp-unit.

BATTERY AND LIGHTING SYSTEM

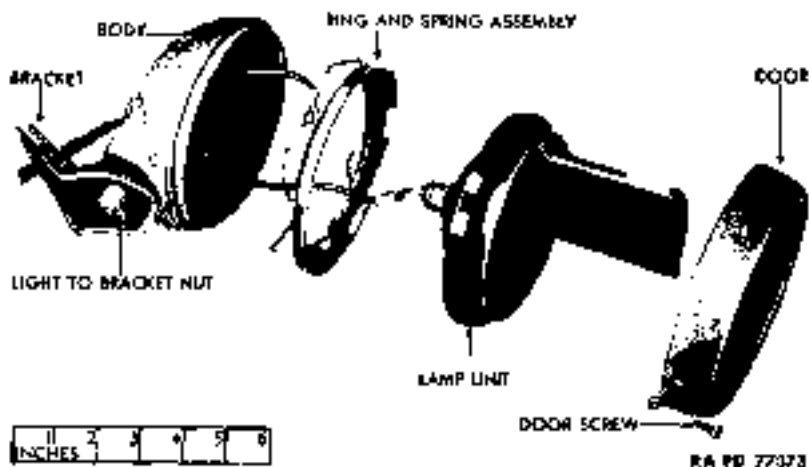

Figure 99 - Blackout Driving Light Disassembled

(2) TABULATED DATA.

Manufacturer	Guide
Model	3012-B
Type	Sealed-beam

b. Maintenance.

(1) **REPLACE SEALED BEAM LAMP-UNIT.** Remove screw which secures door to body, and remove door and sealed beam lamp-unit from body. Remove ring and spring assembly from door, and lift sealed beam lamp-unit from door. Disconnect wire from terminal at rear center of lamp-unit, and attach wire to terminal of new unit. Position unit in door, and install ring and spring assembly. Position door to body, and secure with screw.

c. Removal.

(1) **DISCONNECT WIRE.** Disengage wire from blackout driving light switch. Attach a 6-foot wire or cord to end of wire, and attach other end of cord to steering tube support bracket.

(2) **DETACH LIGHT.** Remove nut and lock washer which secure light to bracket. Lift light from bracket, and pull wire from cowling. Detach cord from end of wire.

d. Installation.

(1) **ATTACH LIGHT.** Position light on bracket, and secure with lock washer and nut.

(2) **CONNECT WIRE.** Attach free end of cord to end of wire. Pull cord from end in cab, and guide wire through cowling opening be-

4- TO 5-TON 4 x 4 TRACTOR TRUCK (AUTOCAR MODEL U-7144T)

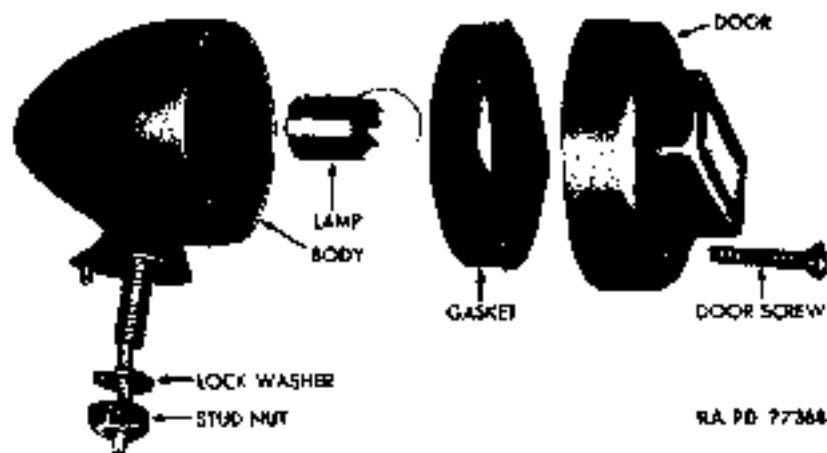

Figure 100 — Blackout Marker Light Disassembled

hind light to switch on instrument panel. Detach cord from wire and remove. Connect wire to terminal on switch.

(3) **TEST OPERATION.** Turn switch "ON," and check operation of light.

158. BLACKOUT MARKER LIGHTS.

a. Description and Tabulated Data.

(1) **DESCRIPTION** (fig. 100). Two blackout marker lights are mounted, one on each side, on brush guard at front of vehicle. Lens in door of light is covered except for two small, translucent, triangular portions. Door is shaped so that triangles are visible only from a straight-ahead position; thus no beam is cast, and light serves only as a marker. Light contains a conventional single-contact socket.

(2) **TABULATED DATA.**

Manufacturer	Guide
Lamp:	
Make	Mazda 63
Candlepower	3
Base	Single-contact

b. Maintenance.

(1) **REPLACE LAMP.** Remove screw which secures door to body, and remove door. Turn lamp and pull from socket, then push new lamp into socket and turn. Position door to body, and secure with door screw.

c. Removal.

(1) **DISCONNECT WIRE.** Disconnect small black-yellow wire at connection behind bumper.

BATTERY AND LIGHTING SYSTEM

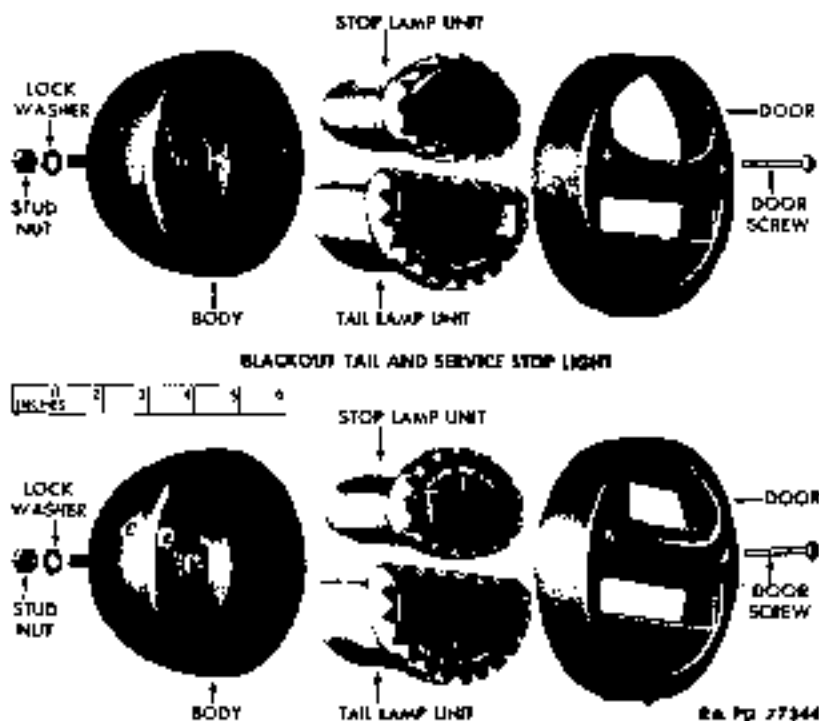

Figure 101 - Tail and Stop Lights Disassembled

(2) **DETACH LIGHT.** Remove nut and lock washer which secure light to bracket, lift light from bracket, and pull wire from cowl.

d. **Installation.**

(1) **ATTACH LIGHT.** Thread wire through opening in bracket. Position light on bracket, and secure with lock washer and nut.

(2) **CONNECT WIRE.** Push wire through cowl opening nearest light, and connect wire behind bumper.

(3) **TEST OPERATION.** Turn blackout lights "ON," and check installation.

159. **BLACKOUT TAIL AND SERVICE STOP LIGHT.**

a. **Description and Tabulated Data.**

(1) **DESCRIPTION** (fig. 101). The blackout tail and service stop light is attached to the frame rear crossmember at the left of the pintle hook. It contains two sealed beam lamp-units, each unit consisting of a lens, lamp, and reflector replaceable only as a unit. The blackout

4. TO 5-TON 4x4 TRACTOR TRUCK (AUTOCAR MODEL U-7144T)

taillight, which emits two small triangles of red light visible only from the rear, operates only when the four-position light switch is in the second position. The service stop light has a red oval lens, and operates with the other service light when the four-position light switch is in third or fourth position.

(2) TABULATED DATA.

Manufacturer	Guide
Type	Sealed-beam
Tail light:	
Model	5933078
Service stop light:	
Model	5933104

b. Maintenance.

(1) **REPLACE LAMP.** Remove the two screws which secure door to body, and remove door. Pull lamp-unit from body, insert new lamp-unit, and push it completely into socket. Position door on body, and secure with the two screws.

c. **Removal.** Disconnect both plugs at rear of light, and remove the two nuts and lock washers which secure light to bracket. Remove light.

d. **Installation.** Position light on bracket, and secure with two lock washers and nuts. Attach plug with two wires on top socket, and plug with one wire to bottom. Test lights for proper operation.

160. BLACKOUT TAIL AND BLACKOUT STOP LIGHT.

a. Description and Tabulated Data.

(1) **DESCRIPTION** (fig. 101). This light is attached to the frame rear crossmember at right of pintle hook, and is similar to the blackout tail and service stop light, except that the blackout stop light emits a small triangle of shielded light visible only from rear.

(2) TABULATED DATA.

Manufacturer	Guide
Type	Sealed-beam
Taillight:	
Model	5933078
Stop light:	
Model	5933121

b. Maintenance.

(1) **REPLACE LAMP** (par. 159).

c. **Removal** (par. 159).

BATTERY AND LIGHTING SYSTEM

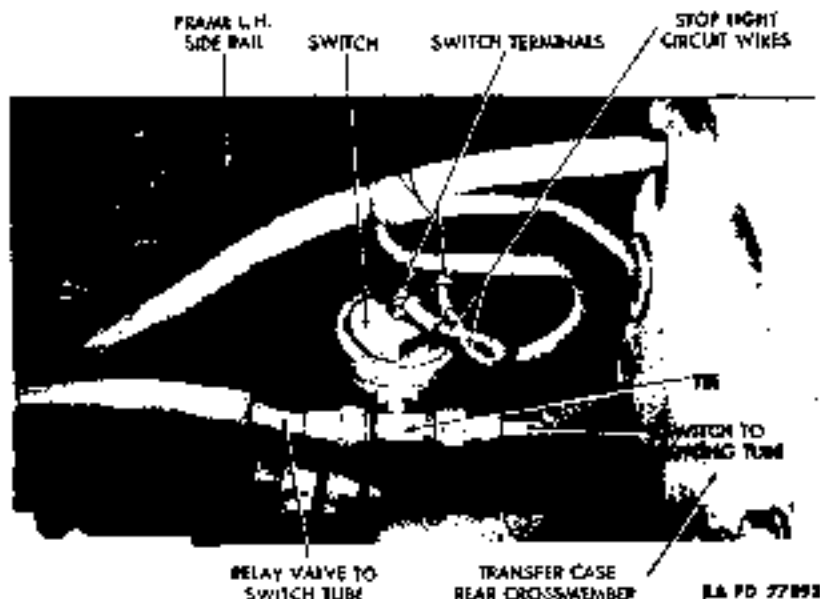

Figure 102 — Stop Light Switch Installed

d. Installation. Position light on frame, secure with the two lock washers and nuts, and install wires. If wires were not tagged, determine correct installation by test. Bottom light should be on with four-positioned light switch in the second position.

161. STOP LIGHT SWITCH.

a. Description and Tabulated Data.

(1) **DESCRIPTION** (fig. 102). This switch is mounted on the left frame side rail behind the transfer case rear crossmember. The switch is air-operated, the working parts consisting of a diaphragm, two contact points, and a coil spring. When brakes are applied, air enters the switch and lifts diaphragm, closing the contacts and lighting stop light. When brakes are released, a coil spring pushes diaphragm down, opening contact points and turning out stop light.

(2) **TABULATED DATA.**

Manufacturer	Westinghouse
Model	215537

b. Removal. Disconnect wires from terminals on switch, and remove hose from tubing on switch. Remove the two nuts, bolts, and four lock washers which secure switch to frame.

4- TO 5-TON 4 x 4 TRACTOR TRUCK (AUTOCAR MODEL U-7144T)

c. **Installation.** Position switch to frame, and secure with the two bolts, nuts, and four lock washers. Connect air hose to tubing on switch, and the two wires to switch terminals (either wire on either terminal). Test operation of stop lights, and check switch for air leakage.

162. INSTRUMENT LIGHTS.

a. Description and Tabulated Data.

(1) **DESCRIPTION** (figs. 3 and 104). Five instrument lights, constructed as a unit and requiring replacement of the entire unit when one light fails, are mounted on the instrument panel.

(2) TABULATED DATA.

Manufacturer	Mazda
Model	T51

b. **Removal.** Disconnect wire at connector behind light, and pull light from instrument panel.

c. **Installation.** Insert wire through instrument light hole in panel, and connect wire at connector. Push light into hole in panel, and pull out four-position light switch to third position. Turn instrument light switch "ON," and check for correct operation.

163. INSTRUMENT LIGHT SWITCH.

a. Description and Tabulated Data.

(1) **DESCRIPTION** (figs. 3 and 104). A rheostat-type switch, attached to instrument panel at right-hand side, operates the instrument panel lights independently when the four-position light switch is in the third position.

(2) TABULATED DATA.

Manufacturer	Delco-Remy
Type	Rheostat

b. **Removal.** Disengage wires from switch, loosen knob set screw, and unscrew knob from switch shaft. Remove switch retaining nut and lock washer, and pull switch from rear side of instrument panel.

c. **Installation.** Position switch to instrument panel, and secure with lock washer and retaining nut. Screw knob on switch shaft and tighten knob set screw. Connect wire from four-position light switch to one terminal, and wire from instrument panel lights to other terminal. Test switch for correct operation.

164. TWIN HORNS.

a. Description and Tabulated Data.

(1) **DESCRIPTION** (fig. 103). Two vibrator-type twin horns are mounted on the cab beneath the battery box. The high pitch of one is

BATTERY AND LIGHTING SYSTEM

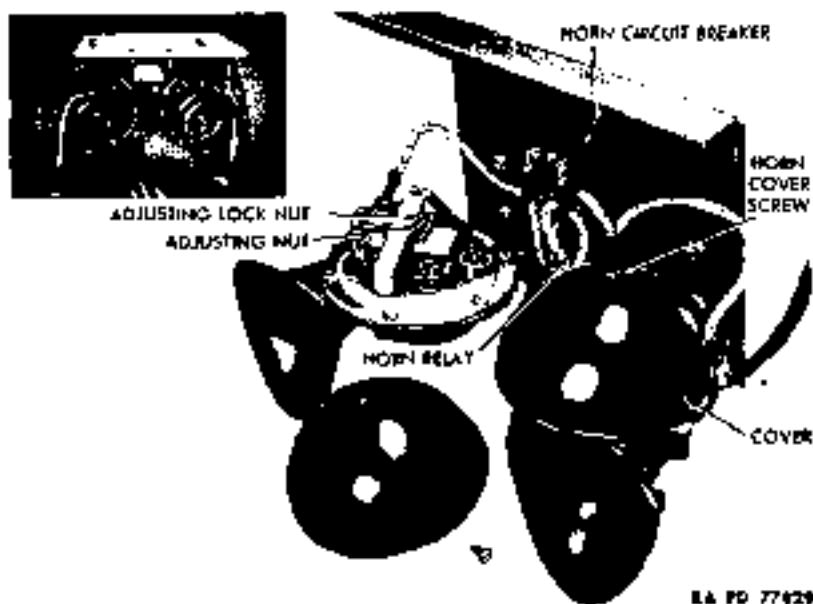

Figure 103 — Twin Horns

tuned to the low pitch of the other to produce the most noticeable type of warning sound. The current to operate the horns is drawn directly from the ammeter through a relay switch controlled by the horn button.

(2) TABULATED DATA.

Manufacturer	Delco
Model	1880391
Type	Air-electric

h. Maintenance.

(1) **ADJUST HORNS.** Remove horn cover screw, and lift cover from horn. Loosen adjusting nut lock nut, and screw or unscrew adjusting nut until desired pitch is obtained. Hold adjusting nut from turning, and tighten lock nut. Position cover on horn, and secure with cover screw.

c. Removal. Disconnect wire from horn terminal. Remove the two nuts, bolts, and four lock washers which secure horn to supporting bracket. Remove horn.

d. Installation. Position horn on bracket, and secure with the two bolts, nuts, and four lock washers. Attach horn wire to terminal. Press horn button, and test for correct operation.

4. TO 5-TON 4x4 TRACTOR TRUCK (AUTOCAR MODEL U-7144T)

165. HORN RELAY.

a. Description and Tabulated Data.

(1) DESCRIPTION (fig 103). A standard magnetic relay switch is attached to the horn support bracket between horns, and serves to supply current directly from ammeter to horns when the horn button is depressed.

(2) TABULATED DATA.

Manufacturer Delco
Model 111681B

b. Removal. Disconnect wires from terminals on relay switch. Remove the two nuts, bolts, and four lock washers which secure switch to bracket, and remove switch.

c. Installation. Position switch on bracket, and secure with the two bolts, nuts, and four lock washers. Attach horn button wire to right-hand terminal, and attach horn wire to left-hand terminal. Connect live wire from ammeter to middle relay terminal. Depress horn button, and test for correct operation.

166. HORN BUTTON.

a. Description and Tabulated Data.

(1) DESCRIPTION (figs 3 and 88). The horn button is located at the center of the steering wheel. Depressing button causes relay switch to direct current to horns as described in paragraph 165.

(2) TABULATED DATA.

Manufacturer Ross Gear
Model 450029

b. Removal (fig. 88). Disengage horn button wire from horn relay switch. Press button down firmly, and turn it to right or left far enough to release it from steering wheel. Remove button, contact cup, contact cap, and horn button spring from base plate. Pull cable, upper terminal assembly, and insulating ferrule from top of steering column.

c. Installation. Thread cable and upper terminal assembly through insulating ferrule down into steering column. Position horn button spring, contact cup, and contact cap on base plate. Position horn button on contact cup. Depress button firmly, and turn to left or right until button is secured to steering wheel. Connect horn button wire to relay switch, and test for correct operation.

167. CIRCUIT BREAKERS.

a. Description and Tabulated Data.

(1) DESCRIPTION. Five circuit breakers are mounted on vehicle as follows: Ammeter circuit breaker and solenoid circuit breaker

BATTERY AND LIGHTING SYSTEM

are attached to cranking motor switch bracket under floor board in front of operator's seat (fig. 51); buzzer and fuel gage circuit breaker are attached to center of cowl over generator regulator (fig. 49); horn circuit breaker is attached to horn supporting bracket above horns (fig. 103); light circuit breaker is an integral part of the regulator which is attached to cowl dash at center (fig. 49). All circuit breakers are of the thermal type. Heat produced by passage of excessive current due to a short circuit causes breaker to open and close intermittently until the short circuit is eliminated.

(2) TABULATED DATA.

Manufacturer	Spencer Thermostat
Type	Thermal cut-out

b. **Removal.** Remove each circuit breaker as follows: Remove both wires from terminals on circuit breaker. Remove the two nuts, lock washers, and bolts which secure breaker to vehicle.

c. **Installation.** Install each circuit breaker as follows: Position breaker to vehicle. Secure with the two bolts, lock washers, and nuts, and connect wire to each terminal on circuit breaker.

168. TRAILER LIGHT CONNECTION.

a. **Description** (fig. 53). The trailer light connection is attached to front center of deck platform. The receptacle is of the female type with four metal contact blades. A spring metal cover keeps receptacle closed when not in use. Wires from receptacle are attached to the stop light and lighting circuits.

b. **Removal.**

(1) **DISENGAGE RECEPTACLE FROM DECK PLATFORM.** Remove the two nuts, lock washers, and bolts which secure receptacle to deck platform.

(2) **DISCONNECT WIRING.** Remove the screw and lock washer which secure back cover to receptacle. Disconnect wires from receptacle terminals.

c. **Installation.**

(1) **CONNECT WIRES.** Attach blue wire to terminal marked "SL," black-yellow wire to terminal marked "YL," and ground wire to terminal marked "GR." Position back cover to receptacle, and secure with the lock washer and screw.

(2) **ATTACH RECEPTACLE TO DECK PLATFORM.** Position receptacle on platform, and secure with two bolts, lock washers, and nuts.

(3) **TEST INSTALLATION.** Insert trailer male plug into receptacle. Start engine, and build up air pressure, then turn lights "ON," apply brakes, and check for proper operation of trailer stop lights and marker lights.

4. TO 5-TON 4 x 4 TRACTOR TRUCK (AUTOCAR MODEL U-7144T)

Section XXXIII
INSTRUMENTS

169. AMMETERS.

a. Description and Tabulated Data.

(1) DESCRIPTION (figs 3 and 104). Two ammeters are located adjacent to each other on the left side of the instrument panel. The main ammeter registers charging or discharging rate for the entire system. The auxiliary ammeter registers the discharging or charging rate for the auxiliary battery only.

(2) TABULATED DATA.

Manufacturer	Stewart-Warner
Model:	
Ammeter	400056
Auxiliary ammeter	440008

b. Removal. Disconnect the four wires attached to ammeter and the two wires attached to auxiliary ammeter. Tag wires to aid correct installation. Remove the two nuts and lock washers which secure each ammeter to bracket and instrument panel, and pull bracket from each ammeter. Pull ammeters from front of instrument panel.

c. Installation. Position each ammeter in instrument panel. Place brackets on back of each, and secure with the two lock washers and nuts. If wires were not tagged in removal, connect ammeter as follows: red No. 14 wire from cranking motor switch to terminal on right-hand side of vehicle, red No. 10 wire from four-position light switch to left-hand terminal, green No. 10 wire from regulator to left-hand terminal, and wire from ignition switch to left-hand terminal. Connect auxiliary ammeter as follows: ground wire to terminal on right-hand side of vehicle; ground wire from circuit breaker to left-hand terminal. Test by turning lights on and noting ammeter operation; then turn lights off, start engine, and again check for satisfactory ammeter operation.

170. FUEL GAGE.

a. Description and Tabulated Data.

(1) DESCRIPTION (figs 3 and 104) (par. 4). The fuel gage is located on the right side of the instrument panel between the temperature and oil pressure gages. The fuel gage, which is electrically operated, is wired to the fuel gage tank unit which measures the fuel in the tank with a float. This measurement is registered on the dial of the fuel gage in terms of gallons.

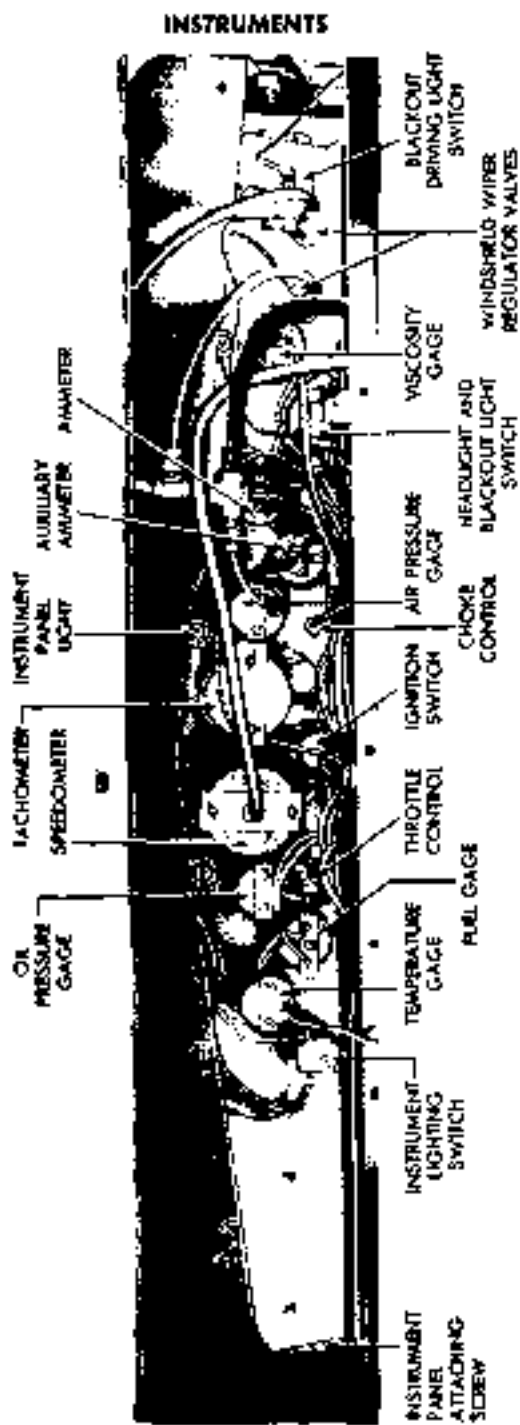

RA PD 77987

Figure 106 - Instrument Panel From Rear

4- TO 5-TON 4x4 TRACTOR TRUCK (AUTOCAR MODEL U-7144T)

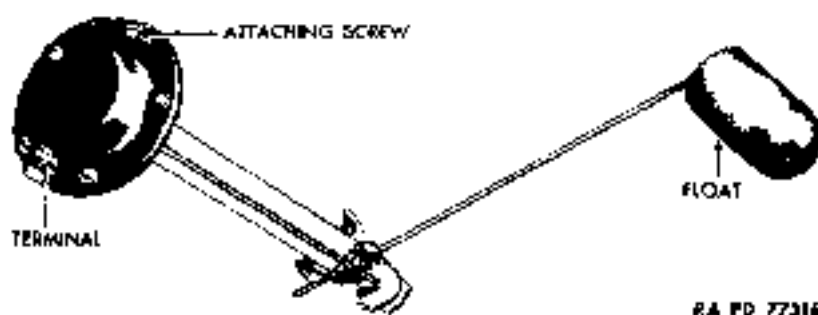

Figure 105 - Fuel Gage Tank Unit

(2) TABULATED DATA.

Manufacturer	Stewart-Warner
Model	441002
Type	Dial

b. **Tank Unit Removal** (fig. 105). Remove the five screws and lock washers which secure fuel tank shield to fuel tank brackets, and remove shield. Disconnect wire from terminal, remove the four screws and lock washers which secure tank unit to tank, and lift unit out.

c. **Tank Unit Installation.** Position unit in tank, and secure with the four screws and lock washers. Connect yellow tank unit to junction block wire to terminal on tank unit. Position fuel tank shield on fuel tank brackets, and secure with the five lock washers and screws.

d. **Gage Removal** (fig. 104). Disconnect the three wires attached to gage. Remove the two nuts and lock washers which secure gage to bracket and instrument panel. Remove bracket, and pull gage from front of panel.

e. **Gage Installation.** Place gage in instrument panel. Position bracket on back of gage, and secure with the two lock washers and nuts. Install circuit breaker to gage wire, gage to buzzer wire, lock washer, and nut on bottom terminal. Install junction block to gage wire, lock washer, and nut on bottom terminal.

171. TACHOMETER AND CABLE.

a. Description and Tabulated Data.

(1) **DESCRIPTION** (figs 3 and 104) (par. 4). The tachometer, located at the approximate center of the instrument panel, registers the revolutions per minute of the engine.

INSTRUMENTS

(2) TABULATED DATA.

Manufacturer	Stewart-Warner
Model	16UKS 31210
Range	0 to 2,400 rpm

b. Head.

(1) **REMOVAL** (fig 104). Disconnect cable at rear of tachometer. Remove the two wing nuts and lock washers which secure gage to bracket and instrument panel. Remove bracket, and pull gage from front of panel.

(2) **INSTALLATION.** Place gage in proper position in instrument panel. Position bracket on back of gage, and secure with two lock washers and wing nuts. Attach cable to rear of tachometer.

c. Cable.

(1) **REMOVAL.** Disconnect cable from tachometer head at instrument panel. Unscrew the knurled sleeve at other end of cable securing it to tachometer drive, and lift out cable.

(2) **INSTALLATION.** Connect cable to tachometer head at instrument panel. Position other end of cable to tachometer drive, and screw on knurled sleeve that holds cable to tachometer drive.

d. Drive.

(1) **REMOVAL.** Remove knurled sleeve at end of tachometer drive cable, and remove cable. Remove tachometer drive adapter, and remove tachometer drive gear.

(2) **INSTALLATION.** Install tachometer drive gear; then install tachometer drive adapter to drive gear. Position cable to adapter, and install by screwing knurled sleeve.

172. SPEEDOMETER AND CABLE.

a. Description and Tabulated Data.

(1) **DESCRIPTION.** The speedometer, located at the right of the tachometer on the instrument panel, registers the road speed of the vehicle in miles per hour.

(2) TABULATED DATA.

Manufacturer	Stewart-Warner
Model	590-X
Range	0 to 60 mph

b. Removal.

(1) **HEAD** (fig. 104). Disconnect cable from rear of speedometer. Remove the two wing nuts and lock washers which secure speedometer to bracket and instrument panel. Remove bracket, and pull gage from front of panel.

4. TO 5-TON 4 x 4 TRACTOR TRUCK (AUTOCAR MODEL U-7144T)

(2) **INSTALLATION.** Place speedometer in instrument panel. Position bracket on back of speedometer, and secure with two lock washers and wing nuts. Attach cable to speedometer.

c. Cable.

(1) **REMOVAL.** Screw off nut that attaches cable to speedometer head. Unscrew knurled screw that secures other end of cable to transfer case. Detach clip holding cable to frame side rail, and remove.

(2) **INSTALLATION.** Position cable between transfer case and speedometer head. Secure cable to head with nut, and other end of cable to transfer case with knurled sleeve. Attach clip which holds cable to frame side rail.

d. Drive.

(1) **REMOVAL.** Unscrew knurled sleeve at end of speedometer drive cable, and remove cable. Remove speedometer drive adapter, and remove speedometer drive gear.

(2) **INSTALLATION.** Install speedometer drive gear to transfer case; then install drive adapter to drive gear. Position cable to adapter, and install by screwing knurled sleeve.

173. OIL PRESSURE GAGE.

a. Description and Tabulated Data.

(1) **DESCRIPTION** (figs. 3 and 104) (par. 4). The oil pressure gage, located at the right of the speedometer, registers the pressure in pounds per square inch of the oil being circulated throughout the engine by the oil pump.

(2) TABULATED DATA.

Manufacturer	Stewart-Warner
Model	400060
Range	0 to 80 lb

b. **Removal.** Remove nut which secures tube to rear of gage. Remove the two nuts and lock washers which secure gage to bracket and instrument panel. Remove bracket, and pull gage from front of panel.

c. **Installation.** Place gage in instrument panel. Position bracket on back of gage. Install the two lock washers and nuts which secure gage to bracket and panel, and attach tube to rear of gage.

174. TEMPERATURE GAGE.

a. Description and Tabulated Data.

(1) **DESCRIPTION** (figs. 3 and 104) (par. 4). The temperature gage, located on the right side of the instrument panel, registers in degrees Fahrenheit the temperature of the fluid in the cooling system.

INSTRUMENTS

(2) TABULATED DATA.

Manufacturer Stewart-Warner
 Model 400059
 Range 100° to 220° F.

h. Removal. Disconnect wire from gage. Remove the two nuts and lock washers which secure gage to bracket and instrument panel. Remove bracket, and pull gage from front of panel.

c. Installation. Place gage in instrument panel. Position bracket on rear of gage. Secure with the two lock washers and nuts, and attach wire to rear of gage.

175. AIR PRESSURE GAGE.

a. Description and Tabulated Data.

(1) DESCRIPTION (par. 4). The air pressure gage is located on the left side of the instrument panel beside the ignition switch. It registers the amount of air pressure in the two air reservoirs.

(2) TABULATED DATA.

Manufacturer .. Stewart-Warner
 Model ... 400060
 Range 0 to 150 lb

h. Removal (fig. 104). Disconnect tube from gage. Remove the two nuts and lock washers which secure gage to bracket and instrument panel. Remove bracket, and pull gage from front of panel.

c. Installation. Place gage in instrument panel, and position bracket on back of gage. Secure with the two lock washers and nuts, and connect tube to gage.

176. VISCOSITY GAGE.

a. Description and Tabulated Data.

(1) DESCRIPTION (par. 4). The viscosity gage is the last gage on the left side of the instrument panel. This gage registers the viscosity of the oil being circulated through the lubricating system by the oil pump.

(2) TABULATED DATA.

Manufacturer Visco Meter Corp.
 Model S 804A

h. Removal (fig. 104). Disconnect tube from rear of gage. Remove the two nuts and lock washers which secure gage to bracket and instrument panel. Remove bracket, and pull gage from front of panel.

c. Installation. Place gage in instrument panel. Position bracket on back of gage, and install the two lock washers and nuts which secure gage to bracket and panel. Tighten tube nut which secures tube to gage.

4. TO 5-TON 4 x 4 TRACTOR TRUCK (AUTOCAR MODEL U-7144T)

Section XXXIV
FIFTH WHEEL

177. DESCRIPTION.

a. Description (fig. 106). The fifth wheel is attached to a mounting plate bolted to the frame side rails at the rear of the truck, and is used to couple tractor and trailer together. It is a swivel-mounted, flat, round steel plate. Rear half of plate forms a V-shaped opening which guides the kingpin neck of the trailer coupling to the coupler jaws at the center of the plate. The kingpin neck snaps the jaws shut, and releases a lever handle to a position that locks the jaws. Disengagement is effected by pulling handle forward, and pushing lever toward the center of the vehicle.

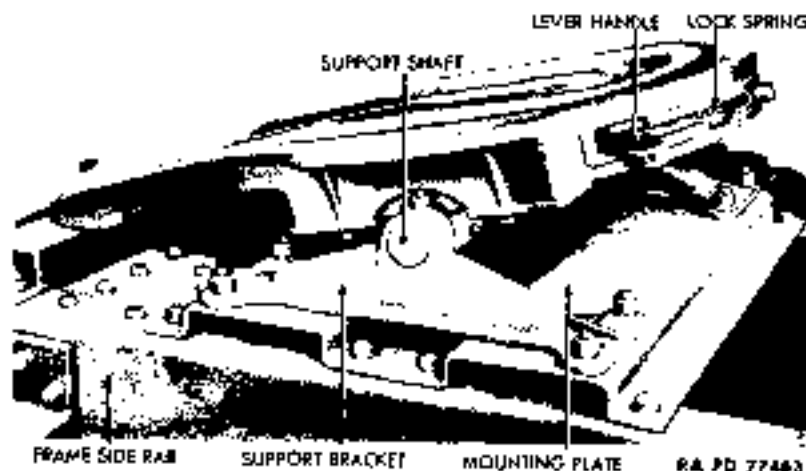

Figure 106 - Fifth Wheel Installed

178. REMOVAL.

a. Remove the four bolts, nuts, and lock washers which secure the two support brackets to the mounting plate. Remove brackets and wheel as an assembly.

179. INSTALLATION.

a. Position fifth wheel assembly on mounting plate. Install the four bolts, nuts, and lock washers which secure brackets to plate.

Section XXXV

RADIO NOISE SUPPRESSION**180. DESCRIPTION.**

a. Automotive ignition systems and ungrounded automotive parts broadcast radio waves which interfere with reception on nearby radios, and enable the enemy to locate the vehicle with detecting instruments. This is overcome by a radio noise suppression system consisting of a dual unit filter, 2 condensers, distributor suppressor, 6 spark plug suppressors, 14 bond straps, and necessary cadmium plated bolts, nuts, and toothed lock washers to bond sheet metal parts.

181. DUAL UNIT FILTER.a. **Description and Tabulated Data.**

(1) **DESCRIPTION** (fig. 107). Two filter units are combined in a single dual unit filter assembly mounted in driver's compartment on dash to left of regulator. The supply filter unit is connected in series in the generator regulator to ammeter battery circuit. The ignition filter unit is connected in series in the ignition switch to coil circuit. Each unit consists of a coil and one or more condensers connected internally in a grounded metal can. The filters cut down radio interference without interfering with the flow of current.

(2) **TABULATED DATA.**

Manufacturer	Tube Deutschmann
Model	1107-OK-DE
Type	Filterette

b. **Maintenance.**

(1) **GENERAL.** If filter is defective, replace entire unit. In an emergency, a filter can be cut out of a circuit, if no replacement is available, by removing both wires which are attached to it and connecting them. **CAUTION:** *Wzap connection with tape. Install new filter at first opportunity. The radio suppression system will not function without it.*

(2) **TEST FILTER UNIT.** Open or short circuit in supply filter unit causes ammeter to show discharge, while open or short circuit in ignition filter renders engine inoperative. Test for open circuit by placing probes of test light on two filter terminals. Failure of lamp to light indicates open circuit. There is no field test for short circuit, therefore, if one is suspected, replace filter.

c. **Removal.** Turn screw in center of face of filter cover one-quarter turn, and lift cover from filter. Disconnect all four wires from terminals of filter. Remove the four nuts, lock washers, and bolts which attach unit to dash. To do this, have one man hold nuts from

4. TO 5-TON 4x4 TRACTOR TRUCK (AUTOCAR MODEL U-7144T)

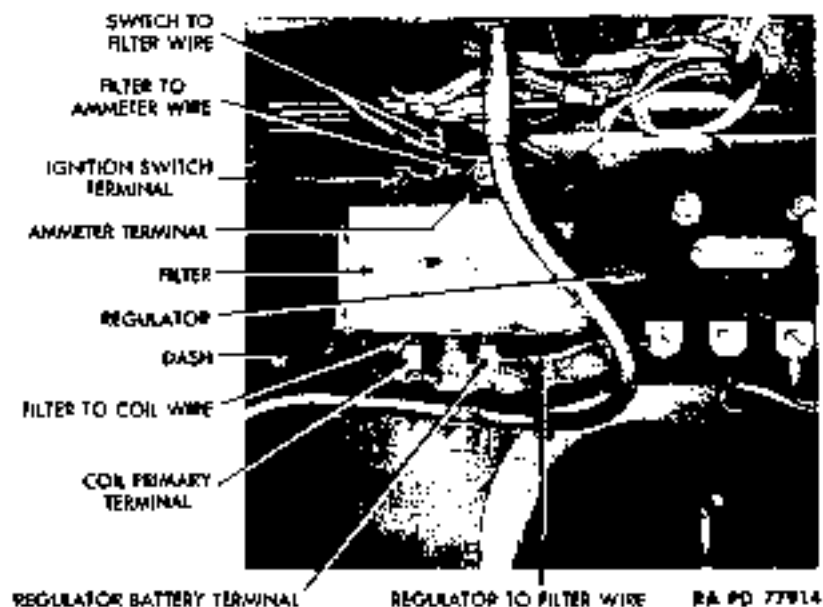

Figure 107 - Dual Unit Filter With Cover Removed

turning through radiator filler door, while another man inside cab turns bolts. Lift unit from dash.

d. **Installation.** Place unit in position on dash. Install the four bolts, lock washers, and nuts which secure unit to dash, with one man working inside cab, and another man working through radiator filler door. Connect red and black wire from ignition switch to terminal marked "IGN SW." Connect red and black wire from coil to terminal marked "COIL PRIM." Connect green wire from ammeter to terminal marked "AMM." Connect green wire from regulator to terminal marked "REG BATT."

182. CONDENSERS.

a. **Description.** One condenser is mounted on generator ground terminal with its lead attached to armature terminal (fig. 48), and one condenser is mounted on an ignition coil mounting screw (fig. 44). Its lead is attached to ignition coil primary terminal.

b. **Maintenance.** A short circuit in the generator condenser will cause ammeter to show discharge, and in the coil, condenser will render engine inoperative. Test condenser suspected of being shorted by disconnecting its lead. If circuit then functions normally, there is a short circuit in condenser, which must be replaced.

RADIO NOISE SUPPRESSION

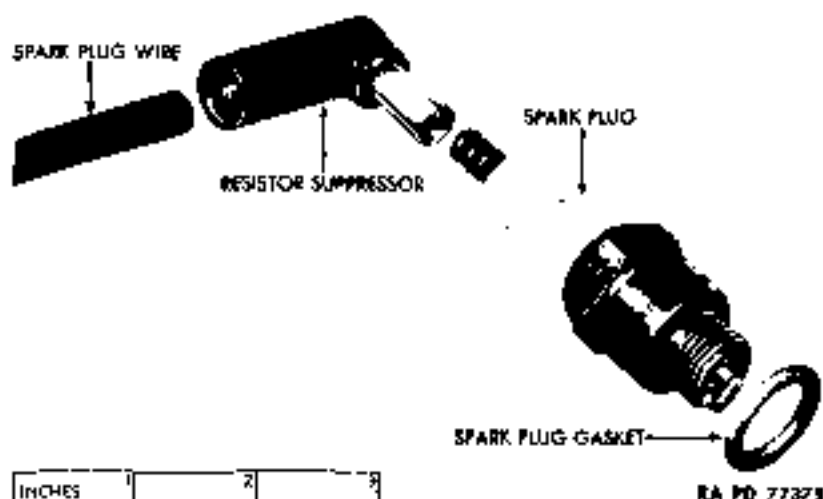

Figure 108 - Spark Plug Resistor Suppressor Installation

c. **Removal.** Disconnect lead, remove screw which attaches condensers, and lift them from vehicle.

d. **Installation.** Place generator condenser bracket in position on generator ground screw hole, and install lock washer and ground screw. Connect condenser lead to generator armature terminal. Place ignition coil condenser in position on ignition coil mounting screw and lock washer, and install screw. Connect condenser lead to coil terminal marked negative.

183. SUPPRESSORS.

a. **Description** (fig. 108). Seven resistor-type suppressors are used, one located on top of each spark plug, and the remaining suppressor in the coil to distributor high tension secondary wire about an inch above the distributor cap.

b. **Maintenance.** Clean dirt and moisture from suppressors with clean cloth. Examine each one carefully, and replace if cracked or scorched.

c. **Removal.** Pull spark plug suppressor from plug, and screw suppressor from spark plug wire. Pull distributor suppressor wire from distributor cap, and unscrew wire from each end of suppressor.

d. **Installation.** Screw spark plug suppressor on end of spark plug wire, and press suppressor on spark plug. Screw distributor suppressor on long portion of coil to distributor wire, and screw short portion of

4. TO 5-TON 4 x 4 TRACTOR TRUCK (AUTOCAR MODEL U-7144T)



RA Pp 77358

Figure 109 - Typical Bonding Installations

wire into other end of suppressor. Push wire into center tower of distributor cap.

184. BOND STRAPS AND BOLTS.

a. Description and Tabulated Data.

(1) DESCRIPTION. Bond straps, cadmium plated bolts, nuts, and lock washers are used to maintain an unbroken circuit through metal parts. Sheet metal parts are bonded to each other by special bolts with cadmium plated toothed lock washers used for good contact.

(2) TABULATED DATA.

Number of bond straps and jumpers	14
Location of bond straps:	
Radiator to crossmember	1
Front corners of cab to frame rail	2
Cab to rear cab support	2
Crankcase to front engine support	1
Right-hand engine support to frame rail	1
Left-hand engine support to frame rail	1
Cylinder head to cab angle	1
Splash shield to frame	2
Cylinder head to manifold shield	1
Fire carrier to cab support	2

b. Maintenance. Inspect bond straps and bond bolts. Replace broken or damaged straps, and tighten loose nuts.

c. Removal. To remove bond strap, remove nut, two lock washers, and bolt which attach each end of strap. Lift strap from vehicle.

SHIPMENT AND TEMPORARY STORAGE

To remove bond bolt, remove nut and lock washer. Pull bolt and second lock washer from sheet metal.

d. **Installation.** To install bond strap, clean corrosion from strap and attaching parts. Place strap in position, and install lock washer, bolt, second lock washer, and nut which attach each end of strap. Tighten nut securely. To install bond bolt, clean corrosion from bolt and attaching parts. Place lock washer on bolt, insert bolt, and install second lock washer and nut. Tighten nut securely.

Section XXXVI

SHIPMENT AND TEMPORARY STORAGE

1B5. GENERAL INSTRUCTIONS.

a. Preparation for domestic shipment of the vehicle is the same as preparation for temporary storage or bivouac. Preparation for shipment by rail includes instructions for loading and unloading the vehicle, blocking necessary to secure the vehicles on freight car, number of vehicles per freight car, clearance, weight, and other information necessary to properly prepare the vehicle for rail shipment. For more detailed information, and for preparation for indefinite storage, refer to AR 850-18.

1B6. PREPARATION FOR TEMPORARY STORAGE OR DOMESTIC SHIPMENT.

a. Vehicles to be prepared for temporary storage or domestic shipment are those ready for immediate service, but not used for less than 30 days. If vehicles are to be indefinitely stored after shipment by rail, they will be prepared for such storage at their destination.

b. If the vehicles are to be temporarily stored or bivouacked, take the following precautions:

(1) **LUBRICATION.** Lubricate the vehicle completely (pars. 16 and 17).

(2) **COOLING SYSTEM.** If freezing temperature may normally be expected during the limited storage or shipment period, test the coolant with a hydrometer and add the proper quantity of antifreeze compound, to afford protection from freezing at the lowest temperature anticipated during the storage or shipping period. Completely inspect the cooling system for leaks.

(3) **BATTERY.** Check battery and terminals for corrosion and if necessary, clean and thoroughly service battery (par. 154).

4- TO 5-TON 4 x 4 TRACTOR TRUCK (AUTOCAR MODEL U-7144T)

(4) **TIRES.** Clean, inspect, and properly inflate all tires. Replace with serviceable tires, all tires requiring retreading or repairing. Do not store vehicles on floors, cinders, or other surfaces which are soaked with oil or grease. Wash off immediately any oil, grease, gasoline, or kerosene which comes in contact with the tires under any circumstances.

(5) **ROAD TEST.** The preparation for limited storage will include a road test of at least 5 miles, after the battery, cooling system, lubrication, and tire services, to check on general condition of the vehicle. Correct any defects noted in the vehicle operation, before the vehicle is stored, or note on a tag attached to the steering wheel, stating the repairs needed, or describing the condition present. A written report of these items will then be made to the officer in charge.

(6) **FUEL IN TANKS.** It is not necessary to remove the fuel from the tanks for shipment within the United States, nor to label the tanks under Interstate Commerce Commission Regulations. Leave fuel in the tanks except when storing in locations where Fire Ordinances, or other local regulations, require removal of all gasoline before storage.

(7) **EXTERIOR OF VEHICLE.** Remove rust appearing on any part of the vehicle exterior with flint paper 2/0. Repaint painted surfaces whenever necessary to protect wood or metal from deterioration. Exposed polished metal surfaces which are susceptible to rust, such as winch cables, chains, and, in the case of track-laying vehicles, metal tracks, should be coated with a protective medium grade lubricating oil. Close firmly all cab doors, windows, and windshields. Vehicles equipped with open-type cabs with collapsible tops will have the tops raised, all curtains in place, and the windshield closed. Make sure tarpaulins and window curtains are in place and firmly secured. Leave rubber mats, such as floor mats, where provided, in an unrolled position on the floor, and not rolled or curled up. Equipment, such as Pioneer and truck tools, tire chains, and fire extinguishers, will remain in place in the vehicle.

(8) **INSPECTION.** Make a systematic inspection just before shipment or temporary storage, to insure all above steps have been covered, and that the vehicle is ready for operation on call. Make a list of all missing or damaged items and attach it to the steering wheel. Refer to Before-operation Service (par. 12).

(9) **ENGINE.** To prepare the engine for storage, remove the air cleaner from the carburetor. Start the engine, and set the throttle to run the engine at a fast idle. Pour 1 pint of medium grade, preservative lubricating oil, Ordnance Department Specification AXS-674, of the latest issue in effect, into the carburetor throat, being careful not to choke the engine. Turn off the ignition switch as quickly as possible after the oil has been poured into the carburetor. With the engine

SHIPMENT AND TEMPORARY STORAGE

switch off, open the throttle wide, and turn the engine five complete revolutions by means of the cranking motor. If the engine cannot be turned by the cranking motor with the switch off, turn it by hand, or disconnect the high tension lead and ground it before turning the engine by means of the cranking motor. Then reinstall the air cleaner.

(10) **BRAKES.** Release brakes, and chock the wheels or tracks.

c. Inspections in Limited Storage.

(1) Vehicles in limited storage will be inspected weekly for condition of tires and battery. If water is added when freezing weather is anticipated, recharge the battery with a portable charger, or remove the battery for charging. Do not attempt to charge the battery by running the engine.

187. LOADING AND BLOCKING FOR RAIL SHIPMENT.

a. **Preparation.** In addition to the preparation described in paragraph 186, when ordnance vehicles are prepared for domestic shipment, the following preparations and precautions will be taken:

(1) **EXTERIOR.** Cover the body of the vehicle with a canvas cover supplied as an accessory.

(2) **TIRES.** Inflate pneumatic tires from 5 to 10 pounds above normal pressure.

(3) **BATTERY.** Disconnect the battery to prevent its discharge by vandalism or accident. This may be accomplished by disconnecting the positive lead, taping the end of the lead, and tying it back away from the battery.

(4) **BRAKES.** The brakes must be applied and the transmission placed in low gear, after the vehicle has been placed in position with a brake wheel clearance of at least 6 inches ("A", fig. 110). The vehicles will be located on the car in such a manner as to prevent the car from carrying an unbalanced load.

(5) All cars containing ordnance vehicles must be placarded "DO NOT HUMP."

(6) Ordnance vehicles may be shipped on flat cars, end-door box cars, side-door box cars, or drop-end gondola cars, whichever type car is the most convenient.

b. **Facilities for Loading.** Whenever possible, load and unload vehicles from open cars under their own power, using permanent end ramps and spanning platforms. Movement from one flat car to another along the length of the train is made possible by cross-over plates or spanning platforms. If no permanent end ramp is available, an improvised ramp can be made from railroad ties. Vehicles may be loaded in gondola cars without drop ends by using a crane. In case of

4- TO 5-TON 4x4 TRACTOR TRUCK (AUTOCAR MODEL U-7144T)

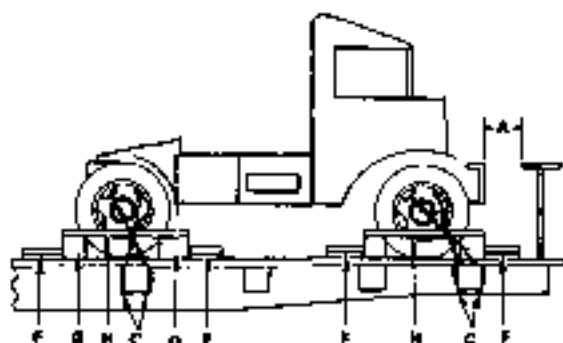
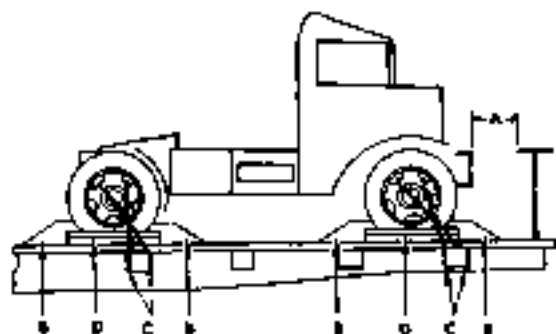

BLOCK-B



BLOCK-D



BLOCK-F



BLOCK-G



BLOCK-H

NA PD 335174

Figure 110 — Blocking Requirements for Securing Wheeled Vehicles on Railroad Cars

SHIPMENT AND TEMPORARY STORAGE

shipment in side-door box cars, use a dolly-type jack to fit the vehicles into position within the car.

c. **Securing Vehicles.** In securing or blocking a vehicle, three motions (lengthwise, sidewise, and bouncing), must be prevented. There are two approved methods of blocking the vehicles on freight cars, as described below. When blocking dual wheels, all blocking will be located against the outside wheel of the dual.

(1) **METHOD 1** (fig. 110). Locate eight blocks "B", one to the front, and one to the rear of each wheel. Nail the heel of each block to the car floor, using five 40-penny nails to each block. That portion of the block under the tread will be toenailed to the car floor with two 40-penny nails to each block. Locate two blocks "D" against the outside face of each wheel. Nail the lower block to the car floor with three 40-penny nails, and the top block to the lower block with three 40-penny nails. Pass four strands, two wrappings of No. 8 gage, black annealed wire "C" through the holes in the wheels and then through the stake pockets. Tighten the wires enough to remove slack. When a box car is used, this strapping must be applied in a similar fashion and attached to the floor by the use of blocking or anchor plates. This strapping is not required when gondola cars are used.

(2) **METHOD 2** (fig. 110). Place 4 blocks "G", 1 to the front and 1 to the rear of each set of wheels. These blocks are to be at least 8 inches wider than the over-all width of the vehicle at the car floor. Using 16 blocks "F", locate 2 against blocks "G" to the front of each wheel, and 2 against blocks "G" to the rear of each wheel. Place 4 blocks "H" against the outside face of each wheel and nail to blocks "G" with three 40-penny nails. Pass 4 strands, 2 wrappings, of No. 8 gage, black annealed wire "C" through the holes in the wheels, and secure as described in Method 1 above.

d. **Shipping Data.**

Length over-all	203½ in.
Width over-all	95½ in.
Height	112¾ in.
Shipping weight	11,660 lb
Approximate floor area	135 sq ft
Approximate volume	1,266 cu ft
Bearing pressure (lb per sq ft)	87

4- TO 5-TON 4 x 4 TRACTOR TRUCK (AUTOCAR MODEL U-7144T)

REFERENCES

PUBLICATIONS INDEXES.

The following publications indexes should be consulted frequently for latest changes or revisions of references given in this section and for new publications relating to material covered in this manual:

- a. Introduction to Ordnance Catalog (explaining SNL system) ... ASF Cat.
ORD 1 IOC
- b. Ordnance Publications for Supply Index (Index to SNL's) ... ASF Cat.
ORD 2 OPSt
- c. Index to Ordnance Publications (listing FM's, TM's, TC's, and TB's of interest to ordnance personnel, OPSE, MWO's, BSD, S of SR's, OSSC's, and OFSB's; and includes Alphabetical List of Major Items with Publications Pertaining Thereto) ... OFSB 1-1
- d. List of Publications for Training (lists MR's, MTP's, T/BA's, T/A's, FM's, TM's, and TR's concerning training) ... FM 21-6
- e. List of Training Films, Film Strips, and Film Bulletins (listing TF's, FS's, and FB's by serial number and subject) ... FM 21-7
- f. Military Training Aids (listing Graphic Training Aids, Models, Devices, and Displays).. ... FM 21-8

STANDARD NOMENCLATURE LISTS.

- Cleaning, preserving and lubricating materials, recoil fluids, special oils, and miscellaneous related items ... SNL K-1
- Soldering, brazing and welding materials, gases and related items ... SNL K-2
- Tool-sets, motor transport. ... SNL N-19
- Truck 4- to 5-ton, 4 x 4, C.O.E., Tractor ... SNL G-510

EXPLANATORY PUBLICATIONS.

Fundamental Principles.

- Automotive electricity ... TM 10-580
- Automotive lubrication ... TM 10-540
- Basic maintenance manual ... TM 38-250
- Driver selection and training ... TM 21-300
- Driver's manual ... TM 10-460
- Electrical fundamentals ... TM 1-455
- Military motor vehicles ... AR 850-15

REFERENCES

- Motor vehicle inspections and preventive maintenance service TM 9-2810
- Precautions in handling gasoline. AR 850-20
- Standard military motor vehicles TM 9-2800
- The internal combustion engine TM 10-570
- Maintenance and Repair.**
- Cleaning, preserving, lubricating and welding materials and similar items issued by the Ordnance Department TM 9-850
- Cold weather lubrication and service of combat vehicles and automotive materiel OFSB 6-11
- Maintenance and care of pneumatic tires and rubber treads TM 31-200
- Ordnance maintenance: 4- to 5-ton, 4 x 4 tractor truck (Autocar and Federal) TM 9-1816
- Ordnance maintenance: Carburetors (Zenith) TM 9-1826C
- Ordnance maintenance: Electrical equipment (Auto-Lite) TM 9-1825B
- Ordnance maintenance: Fuel Pumps TM 9-1828A
- Ordnance maintenance: Hercules engines TM 9-1832A
- Ordnance maintenance: Power brake systems (Bendix-Westinghouse) TM 9-1827A
- Protection of Material.**
- Camouflage FM 5-20
- Decontamination TM 3-220
- Decontamination of armored force vehicles FM 17-59
- Defense against chemical attack FM 21-40
- Explosives and demolitions FM 5-25
- Storage and Shipment.**
- Ordnance storage and shipment chart, group G—
Major items OSSC-G
- Registration of motor vehicles AR 850-10
- Rules governing the loading of mechanized and motorized army equipment also major caliber guns, for the United States Army and Navy, on open top equipment published by Operations and Maintenance Department of Association of American Railroads.
- Storage of motor vehicle equipment. AR 850-18

4- TO 5-TON 4x4 TRACTOR TRUCK (AUTOCAR MODEL U-7144T)

INDEX

A	Page		Page
AGO Form No. 6.....	43	lubrication notes ..	40
AGO Form No. #61		removal, installation and mainte-	
road test	54, 65	mence ..	144
second echelon maintenance	58	road test ..	68
AGO Form No. #78 ..	17, 50, 53, 54	run-in test	51
Aerolizer		trouble shooting	89
connect spring clip	178	Air compressor	
description of pedal	13	description, data, maintenance,	
road test	61	adjustment, and removal....	191
Accessories		installation	193
after-operation service	32	road test ..	66
before-operation service	25	Air pressure gage	
during operation service	30	before-operation service	26
road test	62	data, installation and removal	255
run-in test	51	description ..	12, 255
Adjusters, clock		road test ..	58, 60
data and adjustment.....	208	run-in test ..	53
description	207	trouble shooting ..	106
installation and removal ..	210	Ammeter	
road test		before-operation service ..	25
front brakes	74	data, removal and installation ..	230
rear brakes ..	79	description	9, 12, 250
Air brakes		run-in test	53
after-operation and weekly serv-		trouble shooting	105
ices (tanks) ..	34	Antifreeze compound	
before-operation service (tanks)	25	adding to coolant ..	17
road test		chart ..	18
air brake system ..	62	road test ..	65
air chambers ..	74	use of	17
application valve and reser-		Axes	
voir ..	78	adjustment (front axle) ..	185
rear brakes ..	79	after-operation and weekly serv-	
run-in test		ices (vents) ..	13
air brake tanks	51	connect declutch shift control rod	127
leaks	55	data and removal	
(See also Brakes)		front axle ..	8, 185
Air cleaner		rear axle	8, 189
after-operation and weekly serv-		description	
ice ..	34	front axle	185
cleaning	101	front axle declutch lever ..	9
cold-weather operation ..	20	rear axle ..	187
connect (to carburetor),	137	during-operation service (vents)	30
data	8, 144	installation	
description	143	front axle ..	187
disconnect (from carburetor)...	136	rear axle ..	180
during-operation service	30		
hot-weather operation	21		

INDEX

A — Cont'd		Page			Page
Axles — Cont'd					
road test					
front axle		77	maintenance and removal		
rear axle		79	driving lights		244
temperatures		62	marker lights		242
run-in test (vents)		52	taillights		244
trouble shooting					
front axle		95	(See also Lights and Lighting system)		
rear axle		90	Body (cab)		
B					
Batteries					
after-operation and weekly services					
		52	after-operation service		34
cold weather operation		19	before-operation service		17
descriptions and data		235	description		228
hot-weather operation		72	during-operation service		30
installation		246	run-in test		53
maintenance		257	trouble shooting		104
removal		238	Band straps and bolts		
road test		64			223, 260, 261
run-in test		51	Brake shoes		
storage and shipment	261, 263		description and data		210
trouble shooting	90, 91, 91		removal and installation		212
Bayonet gage					
installation					
		116	road test		
removal					
		115	front brakes		74
Bearings (road test)					
front wheels					
		76	rear brakes		73
rear wheels					
		73	(See also Propeller shaft brake system)		
Belts					
after-operation service					
		32	Brakes		
during-operation service					
		30	cold-weather operation (brake bands)		20
road test					
adjustment		67	data (diaphragm chambers)		204
unusual noises		61	description		
run-in test		51	application valve		197
Blackout lights					
data					
marker lights		242	brake pedal		9
taillights		244	diaphragm chambers		203
description					
driving lights		240	pedal and control rod		207
light switches	12, 13		service brake system		189
marker lights		242	valve operating lever		13
taillights		243, 244	lubrication notes (governor)		44
installation					
driving lights		241	removal and installation		
marker lights		243	application valve		198
taillights		244, 245	diaphragm chambers		204
road test					
brake pedal		78	pedal and control rod		207
linings and shoes		80, 82	front brakes		
front brakes		74			74
hand brakes		77	hand brakes		77
in general		60	in general		60
rear brakes		72	rear brakes		72
run-in test					
		54	storage and shipment		
storage and shipment					
		262, 263			

4- TO 5-TON 4x4 TRACTOR TRUCK (AUTOCAR MODEL U-7144T)

B - Cont'd		Page		Page
Brakes - Cont'd			disconnect	
trouble shooting	96	air pipe	144	
(See also Air brakes, Brake shoes, and Propeller shaft brake system)			controls	113
Breaker points			Fuel does not reach	88
adjustment of gap	68, 162	hot-weather operation	21	
replacement	162	removal and installation	136	
Breather caps			road test	68
after-operation and weekly services	31	(See also Accessories)		
road test	68	Carriers (See under Tires)		
run-in test	51	Centrifugal advance, (road test)		
Brush guards			68	
installation	151	Chains		
removal	148	data	46, 47	
road test	82	(See also Traction devices)		
Bumpers			Chassis (cold-weather operation)	
after-operation service	34	lubrication of points	16	
before-operation service	26	operation	20	
description, removal, and installation	237	Choke		
during-operation service	30	before-operation service	25	
road test	81	description of choke control	12	
run in test	52	road test	68	
Bushings (rubber), lubrication			run-in test	33
notes	45	use of (cold weather)	19	
C			Circuit breakers	
Cabs			data, removal and installation	249
connect to support brackets	128	descriptions	248	
description, maintenance, and installation (cab top)	231	road test	82	
disconnect support brackets	123	Clutch		
removal		data, maintenance, and adjustment	130	
cab	123	description		
cab top	231	clutch	130	
road test		pedal	9	
cab	82	installation		
cab mountings	79	clutch	133	
usual means	62	release bearing oil tube	178	
(See also Body)			lubrication notes	45
Cables	174	position transmission on bell housing	178	
Carbon removal			removal	
Carburetor		clutch	152	
air leaks	86	release bearing oil tube	176	
cold-weather operation	20	road test		
connect		clutch	60, 81	
air pipe	144	clutch pedal	77	
controls	113	run-in test	54	
descriptions, data, and adjustment	234	trouble shooting	87	
		Cold-weather operation		15
		Compression, engine, trouble shooting		86

INDEX

C — Cont'd	Page		Page
Compressor (See Accessories and Air compressor)		Cylinder heads and gaskets	
Condensers		fuel does not touch cylinder...	28
data	159	installation	111
description	159, 253	removal	109
installation	160, 259	road test	63
maintenance	258		
removal	159, 259	D	
road test	83	Dash, attach and detach generator	
Conduit (See Wiring and conduit)		regulator to	168
Controls (See Driving controls)		Data (See under specific item)	
Coolant supply, before-operation		Declutch shift control rod	
service	25	connect (front axle)	127
Cooling system		(See also under Linkage)	
data	9	Decontamination	23
description	148	Decontaminator	
drain	109	after-operation service	32
filling	111	before-operation service	27
hot-weather operation	21	road test	34
inspection	17	Description (See under specific item)	
storage and shipment	261	Differential	
trouble shooting	29	cold-weather lubrication	16
Commutator		oil levels (after operation service)	33
cleaning	166	Diluents, tabular data	17
trouble shooting	90	Distance switch, foot, description ..	9
Cowl, position radiator in	150	Distributor	
Crank, starting, data	47	data, maintenance, and adjustment	161
Crankcase		description	160
data	8	cold-weather operation	19
lubrication notes	44	faulty points	90
oil		installation	
installation	115	condenser in distributor	160
keeping fluid	16	distributor	163
road test	65	lubrication notes	45
(See also Ventilator, crankcase)		lubrication (road test)	68
Cranking motor		removal	162
cold-weather operation	18	road test	67, 68
connect switches	128	(See also Accessories)	
data (switch)	172	Doors (road test)	82
description		Drag link	
cranking motor	169	removal and installation	218
switch	9, 172	road test	76
disconnect switches	123	Drawbar, data	8
imperative	91, 92	Drive flanges (road test)	
inspection (cold weather)	19	front propeller shaft	73
installation and removal		front wheels	76
cranking motor	170	rear wheels	73, 74
cranking motor switch	171	Driver's Report Accident ..	27, 35, 84
trouble shooting	86		
(See also Accessories)			

4- TO 5-TON 4 x 4 TRACTOR TRUCK (AUTOCAR MODEL U-7144T)

D - Cont'd		Page	Page
Driver's Trip Ticket and Preventive Maintenance Service Record, Form No. 48	23	storage and shipment.....	261
Drives, before-operation service ..	25	trouble shooting	35, 86
Driving controls, description.....	9	run-up	109
Driving the vehicle.....	13	unusual noises	62
Duty roster (AGO Form No. 6) ...	45	warming	18, 15, 53
E		Equipment	
Echelon (maintenance services)		lubrication	40
first echelon	23, 56	(See also Tools and equipment)	
second echelon	55	Exhaust pipe	
Electrical systems, cold-weather operation	18	connect and disconnect	114
Engine		data, removal, and installation ..	143
after-operation service		description	144
controls	33	road test	80
operation	31	trouble shooting	89
attach and detach		(See Intake and exhaust system)	
fuel pump	138		
rope sling	125	F	
before-operation service		Fan	
operation	27	adjustment and installation of fan belts	137
warm-up	15	description, data, and removal	
cleaning	34	fan	155
cold-weather operation	19	fan belt	47, 157
data	109	maintenance (fan belt)	
description	107	but weather	21
disconnect support rods	127	loose or broken belt	89
engine idle and vacuum test ..	70	road test	65
excessive oil consumption ..	87	(See also Accessories)	
installation		Fenders	
engine	127	after-operation service	34
hood	151	before-operation service	26
misfires	87	description, maintenance, removal, and installation	234
overheating	89	during-operation service	36
removal		road test	81
engine	119	run-in test	52
hood	150	Filters	
hood assembly	155	dual unit filters	257, 258
replace lubricant and cooling fluid ..	130	road test	83
road test	64, 70, 77	(See also Oil filters and Fuel filters)	
run-in test		Fire extinguisher	
engine	55	after-operation service	32
engine controls	53	before-operation service	25
starting	13	data	47
starting in cold weather	10	road test	83
stopping	14, 87	run-in test	51
		First aid kit, road test.....	84
		Fittings (oil), lubrication notes	40

INDEX

F - Cont'd	Page	Page
Flange nuts (See Wheel and flange nuts)		
Floorboard		
installation	184	
removal	120, 191	
Floorboard insert, removal and installation	138	
Frame		
attach governor to	196	
description	228	
road test	79, 82	
trouble shooting	194	
Fuel filter		
after-operation and weekly services	32	
cleaning (road test)	69	
data, maintenance, and removal ..	119	
description	138	
installation	140	
run-in test	51	
Fuel gage		
before-operation service	28	
connect wire	142	
data, installation, and removal ..	152	
description	12, 250	
road test	60	
run-in test	53	
trouble shooting	105	
Fuel lines		
cleaning	69	
installation, description, removal, and maintenance	143	
road test	66, 79	
Fuel supply		
after-operation service	31	
before-operation service	25	
cans and brackets (road test) ..	84	
data	6	
leak (road test)	62, 69	
run-in test	51	
storage and shipment	262	
(See also Gasoline)		
Fuel system		
cold-weather operation	10	
data and maintenance (tank) ..	143	
description		
fuel system	134	
fuel tank	140	
removal and installation (tank)	142, 252	
road test	79	
trouble shooting	86, 88	
G		
Gages		
road test	59	
run-in test	54	
(See also Air pressure gage, Bayonet gage, Fuel gage, Oil pressure gage, Temperature gage, and Viscosity gage)		
Gaskets (See Cylinder heads and gaskets and Manifolds and gaskets)		
Gasoline (cold-weather operation)	15	
Gear cover, lubrication notes	44	
Gearshift finish plate		
installation	128	
removal	123	
Generating system		
description	165	
trouble shooting	90	
Generator		
cold-weather operation	18	
data and maintenance	166	
description	165	
installation and removal	167	
polarize	168	
road test	66	
trouble shooting	107	
(See also Accessories)		
Generator regulator	168	
Gloss and mirrors		
after operation service	31	
before-operation service	26	
during-operation service	30	
road test	60	
run-in test	52	
Governor		
attach and detach valve box	114	
data, maintenance, adjustment, and removal	105	
description	194	
installation	196	
lubrication notes	44	
road test	66, 68	
trouble shooting	86	
Grille (road test)	87	

4- TO 5-TON 4 x 4 TRACTOR TRUCK (AUTOCAR MODEL U-7144T)

H	Page	I	Page
Handling gasoline (cold weather) ..	15	Idle, engine road test	61, 70
Headlights		Ignition system	
description and data		data, removal, and installation	
headlights	239	ignition coil	158
switch	12	ignition switch	164
maintenance, removal and installation	140	description	
(See also Lights and Lighting system)		ignition switch	12, 164
Hercules RXC engine (See Engine)		ignition system	157
Hood, engine		timing	
installation	111, 130, 151	road test	69
removal	109, 120, 150, 155	set	161
road test	82	trouble shooting .	86, 90, 107
Horns		Instrument panel	
after-operation service	31	connect to cowl.....	129
before-operation	16	disengage	123
data, removal, and installation		Instruments	
horn button and horn relay	148	after-operation service	31
twin horns	147	before-operation service	25
description		description	
horn button	13, 248	instruments	250
horn relay	248	lighting switch	12, 248
twin horns	246	lights	246
maintenance (twin horns)	247	road test	59
road test	60	run-in test	53, 54
run-in test	31	trouble shooting	103
Hose connections		Intake and exhaust system	
description, data, removal, and installation	153	description	143
maintenance (hot weather)	21	installation (manifolds and gaskets)	114
road test (tractor-to-trailer) .	81	removal (manifold and gaskets) 113	
Hoses		trouble shooting	88
data	47		
description, maintenance, and removal	206		
installation	207		
road test	74		
Hubs and drums			
adjustment (hub bearings).....	217		
description (hub bearings).....	216	Leaf units, data	47
installation (hub bearings).....	219	(See also Lights and Lighting system)	
removal (hub bearings).....	218	Leaks	
road test		after-operation service	83
drums and supports	72	before-operation service	25
front brakes	74	during-operation service	30
rear brakes	61	repair	17
run-in test	55	road test	62, 65, 69
trouble shooting (hubs)	101	run-in test	54, 55
		Lighting system	
		data	
		instrument lights and switch... 246	
		light switch	238

INDEX

L — Cont'd	Page	Page
Lighting system — Cont'd		
description		first echelon 23
instrument lights and switch..... 116		second echelon 55
light switch 138		Major unit assembly replacement
lighting system .. 135		record 50, 55, 84
trailer light connections..... 149		Manifolds and gaskets (road test) 68
installation and removal		Markings (See Paint and markings)
instrument lights and switch.... 146		Metal surfaces
light switch 138		effect of low temperatures on .. 20
trailer light connections 178, 149		exposed to salt water 21
trailer lighting receptacle..... 176		Mirrors (See Glass and mirrors)
maintenance 237		Misfires (engine) 87
trouble shooting 92		Muffler
(See also Lights)		description, data, removal, and
Lights		installation ... 147
after-operation service 51		road test 80
before-operation service 26		trouble shooting 80
cold-weather operation 10		
road test 82		N
run-in test 54		Noise, unusual
(See also Headlights, Blackout		run-in test ... 55
lights, and Lighting system)		road test 67
Linkage		O
description, installation, and re-		Oil capacity (transmission) 175
moval		Oil filter
propeller shaft brake system . 115		installation and removal 118
transfer case 179, 180		lubrication notes 44
road test		maintenance 117
brakes 77		road test 65
carburetor .. 68		(See also Accessories)
(See also Clutch linkage)		Oil gage
Lubrication		before-operation service ... 25
by ordnance personnel 43		trouble shooting 105
detailed instructions ... 40		Oil levels
equipment 40		after-operation service 33
lubrication guide 35		road test 62, 65
points requiring none..... 45		Oil lens (road test)..... 65
road test		Oil pan
5th wheel 81		cleaning and removal 115
rear wheels ... 74		installation ... 116
steering knuckles 75		Oil pressure adjustment* 117
vehicle 80		Oil pressure gage
(See also under specific items)		description, data, installation,
M		and removal 12, 104
MWO (Modification Work		disconnect ... 121
Order) 50, 11, 84		road test .. 59
Maintenance		
before operation 11		

INDEX

5 -- Cont'd		Page	Page
Shock absorber—Cont'd			
installation		215	
road test			
front shock absorbers		76	
rear shock absorbers		79	
trouble shooting		102	
(See also Springs and shock absorbers)			
Slip joints (lubrication notes)		14	
Solenoid switch		171	
Spark plugs			
cold-weather operation		19	
data		47, 163	
description, removal, maintenance and adjustment		163, 165	
faulty plugs		90	
installation		111, 164, 165	
road test		64	
Specific gravity			
data		235	
hot-weather operation		22	
road test		64	
use of electrolyte		237	
Speedometer			
cold-weather operation (cable)		20	
description, data, installation and removal		12, 253, 254	
road test		69	
trouble shooting		105	
Spends			
data		8	
road test		61	
Splash shield			
installation		113, 114, 160, 163	
removal		112, 148, 159, 162	
road test		83	
Springs			
description			
front springs		210	
rear springs		211	
installation			
front springs		210	
rear springs		222	
removal			
front springs		220	
rear springs		221	
road test			
front springs		75	
rear springs		79	
trouble shooting		102	
(See also Springs and shock absorbers)			
Springs and shock absorbers			
after-operation service		33	
before-operation service		30	
during-operation service		30	
run-in test		52	
Starter (road test)		69	
Starting system			
description		165	
trouble shooting		90	
Starting the engine		13, 19	
Steering			
road test		61, 76	
run-in test		55	
Steering gear			
after-operation service		33	
data		8, 225	
description, maintenance, and adjustment		225	
lubrication of housing (cold weather)		16	
removal and installation of wheel		226	
trouble shooting		103	
Steering knuckles (road test)		75	
Steering linkage			
after-operation service		33	
before-operation service		26	
during-operation service		30	
run-in test		51	
Steps		235	
Stop lights			
data, maintenance, and removal			
blackout stop light		244	
service stop light		244	
switch		245	
description			
blackout stop light		244	
service stop light		243	
switch		243	
installation			
blackout stop light		245	
service stop light		244	
switch		246	
(See also Lights)			
Stopping			
engine		14, 27	
vehicle		14	

4- TO 5-TON 4 x 4 TRACTOR TRUCK (AUTOCAR MODEL U-3144T)

5 - Cont'd		Page			Page
Storage and shipment			Tire carrier		
cold weather (gasoline)	15		installation	119	
data	265		removal	120	
hot weather	22		road test	71	
rail shipment	263		Tires		
temporary or domestic	261		after-operation and weekly		
Strainer and water trap	115		service	33	
Suppressors	83, 259		before-operation service	26	
Suspensions			data	5, 219	
after-operation service	33		description, maintenance,		
before-operation service	30		removal and installation	219	
during-operation service	30		during-operation service	30	
run-in test	52		road test	70, 71	
			run-in test	52	
			storage and shipment	163	
			trouble shooting	102	
			Toeboards and inserts		
			installation	130, 194	
			removal	120, 191	
			Toe-in		
			road test	80	
			test and adjustment	185	
			Tools and equipment		
			after-operation and weekly		
			services	35	
			before operation service	27	
			data	47	
			organizational	85	
			road test	83	
			run-in test	54	
			storage on vehicle	46	
			Tow hooks		
			description, removal, and		
			installation	132	
			road test	82	
			Towing		
			data	8	
			devices	84	
			disabled vehicle	14	
			Towing connections		
			after-operation and weekly		
			service	34	
			before-operation service	27	
			during-operation service	30	
			run-in test	52	
			Traction devices, road test	84	
			Tractor truck		
			adjustment	57	
			cleaning	34, 40, 57	

INDEX

T — Cont'd	Page	V	Page
Tractor truck — Cont'd		Valves	
data	6, 8	adjustment	
description ..	5	unloader valve	67
driving controls	9	valve tappet	112
first echelon maintenance.....	23, 36	data	
lubrication	34, 51, 57, 67	double check valve	202
operation	13, 15, 20, 21	hand control valve	199
road test	59	relay valve	200
run-in test	51, 55	safety valve ..	197
second echelon maintenance.....	55, 56	single check valve ..	203
tools (See Tools and equipment)		description	
trouble shooting	85	double check valve ..	201
Transfer		hand control valve ..	199
after-operation and weekly		quick release valve ..	200
service	33	relay valve	200
during-operation service	30	safety valve	196
road test	61, 62, 78	single check valve ..	203
run-in test ..	52, 54	removal and installation	
Transfer case		double check valve ..	202
description and data		hand control valve ..	200
shift lever	9	quick release valve ..	201
transfer case ..	8, 179	relay valve ..	200
installation ..	181	safety valve ..	197
trouble shooting	94	single check valve ..	203
Transmission		road test	
after-operation service	33	unloader valve	66, 67
data	8	valve mechanism	63
description and data	175	Vehicle (See Tractor truck)	
installation	178	Ventilator, crankcase	
lubrication (cold weather).....	16	connect and disconnect tube	114
removal ..	126	installation	110, 128
road test ..	61, 62, 78	maintenance ..	118
run-in test ..	54	removal	119
trouble shooting	94	road test	82
Trouble shooting	85	Vents, axle and transfer	
Tubing, maintenance	20b	after-operation and weekly	
Turning stops (road test)...	80	services ..	33
Turntable (fifth wheel) lubrication		during-operation service ..	30
notes	45	run-in test	52
U			
Universal joints		Vicrometer	
data ..	184	before-operation service	26
description ..	181	road test	59
installation and removal	184	Viscosity gage	
lubrication notes	44	connect and disconnect	
road test	62	tube ..	116, 122, 129
trouble shooting	95	data, installation, and removal...	155
Vacuum test (engine) ..	70	description	8, 255

4- TO 5-TON 4 x 4 TRACTOR TRUCK (AUTOCAR MODEL U-71447)

V - Cont'd	Page		Page
Viscosity gauge - Cont'd		road test	
run-in test	53	fifth wheel	81
trouble shooting	10b	front wheels	76
		rear wheels	73
W		unusual noises	62
W.D. Form No. 48	23	wheel rims	71
Water outlet manifold		trouble shooting	102
installation	113	(See also Steering wheel)	
removal	116	Winch (road test)	81
Water supply		Windshield assembly	
after-operation service	31	description and removal	129
road test		installation	231
cans and brackets	84	road test	82
leaks	62, 69	Windshield wipers	
run-in test	51	after-operation service	31
Water trap (See Steamer and		before-operation service	26
water trap)		connect air tube to regulator	
Wheel and flange data		valve	129
before-operation service	76	data, maintenance, removal,	
during-operation service	30	and installation	229
lubrication notes (turntable)	45	description	
run-in test	52	regulator valves	12
Wheels		wipers	218
description and data		disconnect air tube from	
fifth wheel	256	regulator valve	123
wheels	216	road test	60
installation		run-in test	53
fifth wheel	256	trouble shooting	104
spare wheel	179	Wiring, electrical	
wheels	216	after-operation service	32
removal		cold-weather operation	18
fifth wheel	256	description	164
spare wheel	176	maintenance, removal, and	
wheels	216	installation	165
		run-in test	52
		Wiring and conduit (road test)	62, 79

TECHNICAL MANUAL

4- to 5-TON 4 X 4 TRACTOR TRUCK

(AUTOCAR MODEL U-7144T AND WHITE MODEL 444T)

CHANGES]
No. 1]

DEPARTMENT OF THE ARMY
WASHINGTON 25, D. C., 1 June 1951

TM 9-816, 21 March 1944, is changed as follows:

The title of the manual is changed to: 4- TO 5-TON 4X4 TRACTOR TRUCK (AUTOCAR MODEL U-7144T AND WHITE MODEL 444T).

1. Scope

b. In addition to a description of the 4- to 5 ton 4x4 tractor truck (Autocar Model U-7144T and White Model 444T), this manual contains technical information required for the identification, use, and care of the matériel. The manual is divided into three parts. Part one, section one through section VI, gives operating instructions. Part two, section IX through section XXXV.I, gives vehicle maintenance instructions to using arm personnel charged with the responsibility of doing maintenance work within their jurisdiction. Part three, sections XXXVII and XXXVIII, contains instructions for shipment and limited storage and destruction to prevent enemy use of the vehicle. The appendix at the end of the manual contains a list of references including supply catalogs, forms, technical manuals, and other publications applicable to the matériel.

c. In all cases proper instructions issued.

Note. The replacement of certain assemblies, that is, front axle, rear axle, clutch, engine, transmission, and transfer case is normally an ordnance maintenance operation, but may be performed in an emergency by the using organization, provided authority for performing these replacements is obtained from the responsible commander. A replacement assembly, any tools needed for the operation which are not carried by the using organization, and any necessary special instructions may be obtained from the supporting ordnance maintenance unit.

1.1 Forms, Records, and Reports (Added)

a. GENERAL. Forms, records, and reports are designed to serve

* This change supersedes those portions of TB ORD 196, 2 January 1949; TB ORD 206, 29 September 1944; TB ORD 219, 4 April 1945; TB ORD 342, 3 July 1946, pertaining to the matériel covered herein.

necessary and useful purposes. Responsibility for the proper execution of these forms rests upon commanding officers of all units operating and maintaining vehicles. It is emphasized, however, that forms, records, and reports are merely aids. They are not a substitute for thorough practical work, physical inspection, and active supervision.

b. **AUTHORIZED FORMS.** The forms generally applicable to units operating and maintaining these vehicles are listed in the appendix. No forms other than those approved for the Department of the Army will be used. For a current and complete listing of all forms, refer to current SR 316-20-G.

c. **FIELD REPORT OF ACCIDENTS.** The reports necessary to comply with the requirements of the Army safety program are prescribed in detail in the SIT 385-10-40 series of special regulations. These reports are required whenever accidents involving injury to personnel or damage to matériel occur.

d. **REPORT OF UNSATISFACTORY EQUIPMENT OR MATERIALS.** Any suggestions for improvement in design and maintenance of equipment, safety and efficiency of operation, or pertaining to the application of prescribed petroleum fuels, lubricants, and/or preserving materials will be reported through technical channels, as prescribed in SR 700-45-5, to the Chief of Ordnance, Washington 25, D. C., ATTN: DRDFM, using DA AGO Form 468, Unsatisfactory Equipment Report. Such suggestions are encouraged in order that other organizations may benefit.

2. Description

(figs. 1 and 2)

a. The 4- to 5-ton 4x4 tractor truck (Autocar Model U-7144T and White Model 444T) is a cab-over-engine vehicle. Power is furnished * * * the right side.

b. (Rescinded)

2.1 Differences Between Models

(Added)

a. These tractor trucks are manufactured in both open and closed cab-type vehicles.

b. The Autocar Model U-7144T and White Model 444T are identical except that they are manufactured by different manufacturers.

Section IV
OPERATION UNDER UNUSUAL CONDITIONS
(Superseded)

7. General Conditions

a. In addition to the operating procedures described for usual conditions, special instructions of a technical nature for operating and servicing this vehicle under unusual conditions are contained or referred to herein. In addition to the normal preventive maintenance service, special care in cleaning and lubrication must be observed where extremes of temperature, humidity, and terrain conditions are present or anticipated. Proper cleaning, lubrication, and storage and handling of fuels and lubricants not only insure proper operation and functioning, but also guard against excessive wear of the working parts and deterioration of the matériel.

b. TM 21-800 contains very important instructions on driver selection, training, and supervision and TM 21-305 prescribes special driving instructions for operating wheeled vehicles under unusual conditions.

Caution: It is imperative that the approved practices and precautions be followed. A detailed study of these technical manuals is essential for use of this matériel under unusual conditions.

c. Refer to the lubrication order for lubrication, to tables I and II for preventive maintenance checks, and to section XXXV.1 for maintenance procedures under unusual conditions.

d. When chronic failure of matériel results from subjection to extreme conditions, report of the condition should be made on DA AGO Form 468 (par. 1.1).

8. Extreme-Cold Weather Conditions

a. GENERAL PROBLEMS.

- (1) Extensive preparation of matériel scheduled for operation in extreme-cold weather is necessary. Generally, extreme cold will cause lubricants to thicken or congeal, freeze batteries or prevent them from furnishing sufficient current for cold-weather starting, crack insulation and cause electrical short circuits, prevent fuel from vaporizing and properly combining with air to form a combustible mixture for starting, and will cause the various construction materials to become hard, brittle, and easily damaged or broken.
- (2) For description of operations in extreme-cold, refer to FM 70-15 and TM 9-2855.

Caution: It is imperative that the approved practices and precautions be followed. TM 9-2855 contains information which is specifically applicable to this vehicle as well as to all other vehicles. It must be considered an essential part of this manual, not merely an explanatory supplement to it.

b. WINTERIZATION EQUIPMENT. Information on winterization equipment used for operation in extreme-cold weather (0° to -65° F.) is contained in TM 9-2855.

c. FUELS, LUBRICANTS, AND ANTIFREEZE COMPOUNDS (STORAGE, HANDLING, AND USE). The operation of equipment at Arctic temperatures will depend to a great extent upon the condition of the fuels, lubricants, and antifreeze compounds used in the equipment. Immediate effects of careless storage and handling or improper use of these materials are not always apparent, but any deviation from proper procedures may cause trouble at the least expected time. Refer to TM 9-2855 for detailed instructions.

9. Extreme-Cold Weather Operation

a. GENERAL.

- (1) The driver must always be on the alert for indications of the effect of cold weather on the vehicle.
- (2) The driver must be very cautious when placing the vehicle in motion after a shutdown. Congealed lubricants may cause failure of parts. Tires frozen to the ground or frozen to the shape of the flat spot while not inflated must be considered. One or more brake shoes may be frozen fast and require preheating to avoid damage to the clutch surfaces. After warming up the engine thoroughly, place transmission in first gear and drive vehicle slowly about 100 yards, being careful not to stall the engine. This should heat gears and tires to a point where normal operation can be expected.
- (3) Constantly note instrument readings. If temperature gage reading consistently exceeds normal temperature, stop the vehicle and investigate the cause.

b. AT HALT OR PARKING.

- (1) When halted for short shut-down periods, park the vehicle in a sheltered spot out of the wind. If no shelter is available, park so that the vehicle does not face into the wind. For long shut-down periods, if high ground is not available, prepare a footing of planks or brush. Check in place if necessary.

- (2) When preparing a vehicle for shut-down periods, place control levers in the neutral position to prevent them from possible freezing in an engaged position. Freezing may occur when water is present due to condensation.
- (3) Clean all parts of the vehicle of snow, ice, and mud as soon as possible after operation. Refer to table I for detailed after-operation procedures. If the winter front and side covers are not available or installed, be sure to protect all parts of engine and engine accessories against entrance of loose, drifting snow during the halt. Snow flurries penetrating the engine compartment may enter the crankcase filler vent, etc. Cover and shield the vehicle but keep the ends of the canvas paulins off the ground to prevent them from freezing to the ground.
- (4) If no power plant heater is present, the battery should be removed and stored in a warm place.
- (5) Refuel immediately in order to prevent condensation in the fuel tank.
- (6) Check tire pressure (par. 135c).

10. Operation in Extreme-Hot Weather Conditions

a. GENERAL. Continuous operation of the vehicle at high speed or long hard pulls in low gear positions on steep grades or in soft terrain may cause the vehicle to register overheating. Avoid the continuous use of low gear ratios whenever possible. Continuously watch the temperature and halt the vehicle for a cooling-off period whenever necessary and the tactical situation permits. Frequently inspect and service cooling unit, oil filter, and air cleaner. If the engine temperature consistently rises above 200° F., look for dust, sand, or insects in radiator fins and blow out any accumulation with compressed air or water under pressure. Flush cooling system if necessary.

b. AT HALT OR PARKING.

- (1) Do not park the vehicle in the sun for long periods, as the heat and sunlight will shorten the life of the tires. If possible, place vehicle under cover to protect it from sun, sand, and dust.
- (2) Cover inactive vehicles with paulins if no other suitable shelter is available. Where entire vehicle cannot be covered, protect window glass against sand etching, and protect engine compartment against entry of sand.
- (3) Vehicles inactive for long periods in hot humid weather are subject to rapid rusting and accumulation of fungus

growth. Make frequent inspections and clean and lubricate to prevent excessive deterioration.

- (4) Check tire pressure (par. 135a).

11. Operation on Unusual Terrain

a. GENERAL.

- (1) Vehicle operation on snow or ice and in deep mud requires the use of tire chains. Tire chains must be installed in pairs (front and rear) to prevent power train damage and wear. Select a gear ratio low enough to move vehicle steadily and without imposing undue driving strain on engine and power train. However, racing of the engine for extended periods must be avoided.

Note. Avoid excessive clutch slippage.

- (2) Operators must at all times know the position in which the front wheels are steering, as the vehicle may travel straight ahead even though the wheels are cranked right or left. A piece of string tied to the front portion of the steering wheel rim in "straight-ahead" position will indicate to the driver whether the front wheels are "ploughing." This ploughing action may cause the vehicle to stall or suddenly veer to right or left.
- (3) If one or more wheels become mired and others spin, it may be necessary for the vehicle to be winched or towed by a companion vehicle or to jack up the wheel which is mired and insert planking or matting beneath it. Do not jam sticks or stones under a spinning wheel, as this only forms an effective block and will wear the tire tread unnecessarily.
- (4) Operation in sand requires daily cleaning of air cleaners and fuel and oil filters. Engine vents and other exposed vents should be covered with cloth.
- (5) At high altitudes, coolant in vehicles boils at proportionately lower points than 212° F., thus it will be necessary to keep a close watch on the engine temperature during the summer months.
- (6) Check tire pressure (par. 135a).

b. AFTER-OPERATION PROCEDURES. Clean all parts of the vehicle of snow, ice, mud, dust, and sand as soon as possible after operation. Particular care should be taken to remove collections of ice, snow, and mud from the radiator core, engine compartment, steering knuckles and arms, brake chambers and hoses, crankcase ventilator oil filter, air cleaners, and electrical connections.

Caution: Carefully remove accumulations of ice, caked mud, etc. from under fenders.

12. Forging Operations

a. GENERAL. In forging, vehicles may be subjected to water varying in depth from only a few inches to an amount sufficient to completely submerge the vehicle. Factors to be considered are spray splashing precautions, normal forging capabilities, deep-water forging using forging kits, and accidental complete submersion.

b. NORMAL FORDING. Forging of bodies of water up to maximum vehicle forging depth of 24½ inches is based on the standard vehicle with special protection provided for critical units, but without deep-water forging kit. Observe the following precautions:

- (1) Do not exceed the known forging limits of the vehicle.
- (2) The engine must be operated at maximum efficiency before attempting to ford.
- (3) Engage front axle drive; shift transfer case and transmission gearshifts into low range. Speed up engine to overcome the possibility of a "stall" when the cold water chills the engine. Enter the water slowly. If engine stalls while forging, it may be started in the usual manner.
- (4) All normal forging should be at speeds of from 3 to 4 mph to avoid forming a "bow wave." Avoid using the clutch if possible because frequent use while submerged may cause the clutch to slip. If the ford is deep enough for the spinning fan blades to catch water, loosen the fan belt before crossing to prevent the blades from throwing water over the electrical units. The brakes will usually be "lost" but in some cases may "grab" after emergence. Applying the brakes a few times will help dry out the brake linings after dry land has been reached.
- (5) If accidental complete submersion occurs, the vehicle will be salvaged, temporary preservation applied by performing a complete lubrication service (par. 16) and by checking engine crankcase and oil filter (par. 184.3b(5)), and then sent to the ordnance maintenance unit as soon as possible for necessary permanent maintenance.

c. DEEP-WATER FORDING. Refer to TM 9-2853 for general information, descriptions, and methods of use of deep-water forging kits.

d. AFTER-FORDING OPERATIONS. Immediately after vehicle emerges from the water, if tactical situation permits, remove

water from compartments, check engine oil level, and check for presence of water in crankcase. Heat generated by driving will evaporate or force out most water which has entered at various points. Also, any small amount of water which has entered the crankcase either through leakage or due to condensation will usually be dissipated by the ventilating system. Refer to paragraph 11.5 for maintenance operations after fording.

Section V

PREVENTIVE MAINTENANCE BY DRIVER OR OPERATOR

(Superseded)

13. General

a. **RESPONSIBILITY AND INTERVALS.** Preventive maintenance services are the responsibility of the using organization. These services consist generally of before-operation, during-operation, at-the-halt, after-operation, and weekly services performed by the driver or operator; and of the scheduled services performed at designated intervals by organization mechanic or maintenance crews. Intervals are based on normal operations. Reduce intervals for abnormal operations or severe conditions. Intervals during inactive periods may be extended accordingly.

b. **DEFINITION OF TERMS.** The general inspection of each item applies also to any supporting member or connection and is generally a check to see whether the item is in good condition, correctly assembled, secure, and not excessively worn.

- (1) The inspection for "good condition" is usually an external visual inspection to determine whether the unit is damaged beyond safe or serviceable limits. The term "good condition" is explained further by the following: not bent or twisted, not chafed or burred, not broken or cracked, not bare or frayed, not dented or collapsed, not torn or cut, and not deteriorated.
- (2) The inspection of a unit to see that it is "correctly assembled" is usually an external visual inspection to see if it is in its normal assembled position in the vehicle.
- (3) Inspection of a unit to determine if it is "secure" is usually an external visual examination or a check by hand, wrench, or pry-bar for looseness. Such an inspection must include any brackets, lock washers, lock nuts, locking wires, or cotter pins used.

- (4) By "excessively worn" is meant worn beyond serviceable limits or to a point likely to result in failure if the unit is not replaced before the next scheduled inspection.

14. Cleaning

a. **GENERAL.** Any special cleaning instructions required for specific mechanisms or parts are contained in the pertinent section. General cleaning instructions are as follows:

- (1) Use dry-cleaning solvent or volatile mineral spirits paint thinner to clean or wash grease or oil from all parts of the vehicle.
- (2) A solution of one part grease-cleaning compound to four parts of dry-cleaning solvent or volatile mineral spirits paint thinner may be used for dissolving grease and oil from engine blocks, chassis, and other parts. Use cold water to rinse off any solution which remains after cleaning.
- (3) After the parts are cleaned, rinse and dry them thoroughly. Apply a light grade of oil to all polished metal surfaces to prevent rusting.
- (4) Before installing new parts, remove any preservative materials, such as rust-preventive compounds, protective grease, etc.; prepare parts as required (oil seals, etc.); and for those parts requiring lubrication, apply the lubricant prescribed in the lubrication order.

b. **GENERAL PRECAUTIONS IN CLEANING.**

- (1) Dry-cleaning solvent and volatile mineral spirits paint thinner are inflammable and should not be used near an open flame. Fire extinguishers should be provided when these materials are used. Use only in well-ventilated places.
- (2) These cleaners evaporate quickly and have a drying effect on the skin. If used without gloves, they may cause cracks in the skin and, in the case of some individuals, a mild irritation or inflammation.
- (3) Avoid getting petroleum products, such as dry-cleaning solvent, volatile mineral spirits paint thinner, engine fuels, or lubricants on rubber parts, as they will deteriorate the rubber.
- (4) The use of Diesel fuel oil, gasoline, or benzene (benzol) for cleaning is prohibited.

15. Preventive Maintenance by Driver or Operator

a. **PURPOSE.** To insure mechanical efficiency, it is necessary that the vehicle be systematically inspected at intervals each day it is operated, and also weekly, so that defects may be discovered and corrected before they result in serious damage or failure. Certain scheduled maintenance services will be performed at these designated intervals. Any defects or unsatisfactory operating characteristics beyond the scope of the driver or operator to correct must be reported at the earliest opportunity to the designated individual in authority.

b. **SERVICES.** Driver's or operator's preventive maintenance services are listed in table I. Every organization must thoroughly school its personnel in performing the maintenance procedures for this vehicle as set forth in this manual.

Table I. Driver's or operator's preventive maintenance services

Inspection	Interval			Procedure	
	During operation	At the end of	At the end of		
		hour	operation	Weekly	
					USUAL CONDITIONS .
X		X	X	X	<i>Caution:</i> Place all tags describing condition of vehicle in the driver's compartment in a conspicuous location so that they will not be overlooked.
					<i>Fuel, oil, water.</i> Check fuel, oil, and water levels. Look for leaks in engine compartment. Check spare containers for contents.
X			X	X	<i>Tires.</i> Gage tires for correct pressure.
		X	X	X	Remove penetrating objects such as nails or glass. Remove stones from between duals. Note any apparent loss of air, unusual wear, or missing valve caps.
X		X	X	X	<i>Leaks, general.</i> Look under vehicle for indication of fuel, engine oil, gear oil, or water leaks.
X					<i>Vehicle equipment.</i> Visually inspect fire extinguishers and vehicle publications, including necessary forms.
				X	See that fire extinguishers are charged.
X			X	X	Operate lights, horn or siren (if tactical situation permits), and windshield wipers. Visually inspect mirrors, reflectors, etc.
X			X	X	Visually inspect body, towing connections, doors, tractor truck fifth wheel, paulins, tools, etc.

Table 1. Driver's or operator's preventive maintenance services. Continued.

Before operation	Interval				Procedure
	During operation	After half	After operation	Weekly	
X	X			X	<p>USUAL CONDITIONS—Continued</p> <p>Check for any tampering or damage that may have occurred since last inspection. Instruments. Observe for normal readings during warm-up and during operation of vehicle.</p> <p>Caution: If oil pressure gage registers zero or excessively low, shut off engine immediately and investigate cause.</p> <p>General operations. Be alert for any unusual noises or improper operation of steering, clutch, brakes, or gear shifting.</p>
	X			X	<p>Operating faults. Investigate and correct or report any faults noted during operation.</p>
		X	X	X	<p>Springs and suspensions. Look at springs, suspensions, shock absorbers, and torque rods to see if they have been damaged.</p>
			X	X	<p>Fuel filters. Check all fuel filters for leaks.</p>
				X	<p>Remove the drain plug or sediment bowl and remove all water and sediment from the filter (par. 64).</p>
			X	X	<p>Air-brake reservoirs. Drain condensation.</p>
			X	X	<p>Lubricate. Lubricate daily and weekly items specified on lubrication order.</p>
			X	X	<p>Clean. Clean glass and inside of vehicle. Wipe off exterior of vehicle.</p>
				X	<p>Wash vehicle, clean engine, and engine compartment.</p>
				X	<p>Battery. Clean, check water level, and inspect terminals for tightness and coating of grease.</p>
				X	<p>Assemblies and belts. Inspect assemblies such as carburetor, generator, compressor, starter, and water pump for looseness of mounting or connections. Press drive belts to determine if tension is correct (par. 7E).</p>
				X	<p>Electrical wiring. Inspect, visually, electrical wiring, harnesses, and shielding.</p>
				X	<p>Air and transfer vents. Inspect for clogging.</p>

Table I. Driver's or operator's preventive maintenance services—Continued.

	Intervals				Weekly	Procedure
	Before operation	During operation	At-the-halt	After operation		
						<p align="center">UNUSUAL CONDITIONS</p> <p>Preventive maintenance services for usual conditions will apply with emphasis on servicing by the operator to combat the effect of unusual conditions of extreme cold, extreme heat, unusual terrain, and fording. The special services described below are required to assure optimum results under unusual conditions.</p> <p align="center">EXTREME COLD (pars. 8, 9, 184.1 and TM 9-2355)</p> <p>X <i>Cooling and fuel systems.</i> Refuel and add denatured alcohol as required.</p> <p>X <i>Drain fuel tank and fuel tank sump to remove condensation, refuel tank.</i></p> <p>X <i>Check level and specific gravity of radiator coolant. Add ethylene glycol and/or water if needed.</i></p> <p><i>Note: If system contains only antifreeze compound make up a warning tag and place it on or near the radiator filler neck. The tag should read: "THIS COOLING SYSTEM IS FILLED WITH ANILINE ANTIFREEZE COMPOUND. CAUTION. DO NOT ADD WATER OR ANY OTHER TYPE OF ANTIFREEZE."</i></p> <p>X <i>Transmission and transfer interax.</i> Position levers in neutral position.</p> <p>X <i>Tires.</i> Check for tires frozen to ground or for frozen flat spots.</p> <p>X <i>Check for availability and serviceability of air chains.</i></p> <p>X <i>Check for proper pressure (par. 135c).</i></p> <p>X <i>Battery.</i> Check for proper charge.</p> <p>X <i>Remove battery and store in warm place, if vehicle is not equipped with power plant heater.</i></p> <p>X <i>Clean.</i> Clean snow, ice, and mud from all parts of vehicle.</p> <p>X <i>Brakes.</i> Check for frozen brake shoes.</p> <p>X <i>Winterization equipment (if available).</i></p> <p>X <i>Check personnel heater and windshield defrosters for proper operation.</i></p> <p>X <i>Fill power plant heater fuel tank and check unit for proper functioning.</i></p> <p>X <i>Check all winterization equipment for secure installation and proper functioning.</i></p>

Table 1. *Driver's or operator's preventive maintenance services* Continued.

Before operation	Interval				Procedure
	During operation	At the halt	After operation	Weekly	
					UNUSUAL CONDITIONS Continued
X			X		EXTREME COLD—Continued Check winterfront cover, hood blankets, underchassis blankets, hard top enclosure, etc. for security and proper adjustment.
X				X	EXTREME HEAT (para. 10 and 104.2) Cooling and fuel systems. Check air cleaner, fuel and oil filters, and radiator fins and clean as often as necessary to keep them in good condition.
X				X	Battery. Check electrolyte level. Check for proper charge.
		X	X		If necessary to park for extended periods, remove battery and store in cool place.
X				X	Tires. Shield tires, if possible, from direct rays of the sun.
X				X	Check for proper pressure (par. 135c).
			X		UNUSUAL TERRAIN (para. 13 and 104.4) Lubrication. Check for fueled lubricants and lubricate as necessary.
X				X	Tires. Check for proper pressure (par. 135c).
X				X	Check for availability and serviceability of tire chains.
X				X	Cooling and fuel systems. Check air cleaner, fuel and oil filters, and radiator fins and clean as often as necessary to keep them in good condition.
X			X	X	Glaze. Clean all parts of vehicle of snow, ice, mud, dust, and sand.
				X	Check for any sand-blasted surfaces and touch up paint as required.
X			X		Vents. Check engine vents and other exposed vents and keep them covered with cloth.
X					PUMPING OPERATIONS (para. 13 and 104.3) Fording limits. Check vehicle fording limits. Loosen fan belt if required. See paragraph 10.2 for operation precautions.
X			X		Tires. Check for proper pressure (par. 135a).
X				X	Check for availability and serviceability of tire chains. Install if necessary.

Table 1. Driver's or operator's preventive maintenance services—Continued.

Before operation	Interval				Weekly	Procedure
	During operation	After 1 hr	After 100 mi	After 1000 mi		
X				X		UNUSUAL CONDITIONS—Continued FUELING OPERATIONS—Continued Clean. Remove water and sludge from all parts of vehicle and wash with fresh water.
				X		Battery. Check electrolyte for contamination.
				X		Check vent caps for tightness.
				X		Cooling and fuel systems. Check air cleaner, oil and fuel filters, and clean or replace if necessary.
				X		Lubrication. Lubricate as instructed in the lubrication order.

Section VII

TOOLS AND EQUIPMENT STORAGE ON THE VEHICLE

(Rescinded)

Note. For information on parts, special tools, and equipment for organizational maintenance, refer to section XI.

Section VIII. VEHICLE MODIFICATION RECORDS

(Rescinded)

20. Introduction

a. PURPOSE. (Superseded)

- When a new or reconditioned vehicle is first received by the using organization, it is necessary for the organization mechanics to determine whether the vehicle has been properly prepared for service by the supplying organization and to be sure it is in condition to perform any mission to which it may be assigned when placed in service. For this purpose, inspect all assemblies, subassemblies, and accessories to be sure they are properly assembled, secure, clean, and correctly adjusted and/or lubricated. Check all tools and equipment to be sure every item is

present, in good condition, clean, and properly mounted or stowed.

- (2) In addition, perform a run-in test of at least 50 miles on all new or reconditioned vehicles and a sufficient number of miles on used vehicles to completely check their operation, according to procedures in paragraph 21.
- (3) Whenever practicable, the vehicle driver will assist in the performance of these services.

* * * * *

21. Run-In Test Procedures

* * * * *

a. VEHICLE PUBLICATIONS AND REPORTS.

- (1) *Publications.* See that vehicle technical manuals, lubrication order, and Standard Form 91 (**Operator's Report of Motor Vehicle Accident**) are in the vehicle, legible, and properly stowed.

Note. USA registration number and vehicle nomenclature must be filled in on DA AGO Form No. 475, for new vehicles.

* * * * *

22. Second Echelon Preventive Maintenance Services

ii. Regular scheduled maintenance * * * of operating organizations.

- * * * * *
- (4) *General procedures.*

(a) *Special services.*

2. *Clean.* (Superseded) Clean the unit as outlined in paragraph 14 to remove old lubricant, dirt, and other foreign material.

- * * * * *
- (5) *Specific procedures.* The procedures for performing each item in the 1,000 miles or 60 days and 6,000 miles or 6 months maintenance procedures are described in table II. Each page of the table has two columns at its left edge corresponding to the 6,000 miles or 6 months and 1,000 miles or 60 days maintenance respectively. Very often it * * * opposite the number.

Table II. Organizational mechanic or maintenance crew preventive maintenance services

Interval		Procedure
14,000 miles or 6 months ¹	1,000 miles or 60 days ²	
		ROAD TEST
		<p>The driver of a vehicle is often unaware of defects in his vehicle which have developed gradually and to which he has become accustomed. The fact that many drivers lack the ability to detect the developing causes of vehicle failures makes it desirable for the mechanic to road-test the vehicle as part of the periodic preventive maintenance services. Before and during this road test, any repairs and adjustments necessary to insure safe operation should be made. The appropriate paragraph in the following service procedures should be consulted. If a defect found on the road test does not require immediate correction, note it on the check sheet. The defect can be corrected later during the service. Make provisions for securing necessary replacement parts or units.</p> <p>Note: (Superseded) When the tactical situation does not permit a full road test, perform items 2, 3, 4, 5, 6, 8, 10, 12, and 14 which require little or no movement of the vehicle. When a road test is possible, it should be under suitable conditions and for a great enough distance to determine the condition of the vehicle.</p> <p><i>Before-operation service.</i> Perform the before-operation service as described in table I as a check to determine whether the vehicle is in a satisfactory condition to make the road test safely and to see also that the supply of fuel, engine oil, and coolant is adequate.</p>
1	1	
13	13	<p>(Superseded) <i>Temperatures.</i> After completing the run, note as follows:</p> <p><i>Check drums and hubs.</i> Feel all the brake drums and wheel hubs cautiously for abnormal temperatures. An overheated brake drum or wheel hub is an indication of a dragging brake or a defective, dry, or improperly adjusted wheel bearing; an abnormally cool brake drum is an indication of an inoperative brake.</p>

¹ The chart which appears in TM 9-115, 21 March 1944 (pages 58-63, incl.) will be changed so that the "1,000 mile" and "1,000 mile" figures will read "14,000 miles or 6 months" and "1,000 miles or 60 days", as above.

² Whichever occurs first.

Table II. Organizational mechanic or maintenance crew preventive maintenance services—Continued.

Intervals		Procedure
1,600 miles or 6 months ¹	1,000 miles or 60 days ²	
		<p>ROAD TEST—Continued</p> <p><i>Arise, transmission, and torque.</i> Cautiously feel the axle differentials and carriers, transmission, and transfer case for overheating. If any gear case is excessively hot for the distance traveled, an abnormal condition in the unit is indicated. This should be corrected or reported to proper authority.</p>
*	*	<p style="text-align: center;">* * * * *</p> <p style="text-align: center;">MAINTENANCE OPERATIONS</p> <p style="text-align: center;">Raise Vehicle—Block Safely</p> <p>Caution: Use necessary precautions to block the vehicle so it may be operated safely in gear at reasonable speeds. If facilities are not available for adequately and safely jacking up and blocking vehicle, omit the services which follow that require running the engine with power train engaged.</p>
*	*	* * * * *
	19	<p><i>Valve mechanism (clearances, cover gaskets).</i> Adjust valve-stem clearance only if noisy; intake clearance is 0.008 inch (hot). Exhaust clearance is 0.010 inch (hot).</p>
*	*	* * * * *
22	22	<p><i>Battery (cables, hold-down frames, carrier, record gravity, and voltage)</i> Inspect battery case * * * recharged or replaced. Electrolyte level should extend 1/2 inch above plates.</p>
*	*	* * * * *
22	22	<p>Bring electrolyte to * * * damage in battery. Grease terminal connections lightly with general purpose grease.</p>
*	*	* * * * *
21		<p><i>Compression test.</i> Test compression with * * * Form No. 461. If pressure in a cylinder is appreciably below normal, squirt sufficient engine oil on the piston head and recheck compression.</p>

¹ The chart which appears in TM 9-816, 21 March 1943 (pages 58-59, incl.), will be changed so that the "1,600 miles" and "1,000 miles" columns will read "1,600 miles or 6 months" and "1,000 miles or 60 days", as above.

² Whichever occurs first.

Table II. Organizational weakness or non-response crew preventive maintenance services—Continued.

Intervals		Procedure
1,000 miles or 6 months ¹	1,000 miles or 60 days ²	
		<p>MAINTENANCE OPERATIONS— Continued</p> <p><i>Note.</i> Be sure no oil gets on valves. Low compression brought up to normal by oil sealing indicates piston ring or cylinder wear or damage. Low compression not brought up to normal by this method indicates valve or gasket leakage.</p>
32	32	<p><i>Coil and wiring.</i> Inspect coil, ignition * * * in like manner.</p> <p><i>Note.</i> Do not tighten wiring connections unless actually loose as overtightening of terminals will cause damage.</p>
36	36	<p><i>Tire-in and tread-in steps.</i> With front wheels * * * is as specified. The gage should read $3/16$ inch. Turn wheels fully * * * by higher wheelon.</p>
37	37	(Revised)
37	37	(Revised)
96	96	<p><i>Club (doors, hardware, windshield and glass, top and frames, side curtains, seats, pin racks, grab rails, floor boards, ventilators, plat-forms).</i> Inspect these items * * * and not damaged.</p> <p><i>Note.</i> Glass, even if cracked or if laminated layers are separated, need not be replaced as unserviceable unless its condition constitutes a safety hazard or obstructs the vision of driver or crew.</p>
103	103	<p><i>Paint and markings.</i> Examine paint of * * * mountings of furnished. Steel plates rust very readily. When identification plates are found to be in a rusty condition, they should be cleaned thoroughly and heavily coated with applications of clear lacquer.</p>

¹The chart which appears in TM 3 516, 21 March 1914 (pages 55-56, last), will be changed so that the "1,000 mile" and "1,000 mile" columns will read "6,000 miles or 6 months" and "1,000 miles or 60 days", as above.

²Whichever occurs first.

Table II. Organizational procedure or maintenance crew prescriptive maintenance services. Continued.

Interval		Procedure
4,000 miles or 3 months ¹	11,000 miles (¹) 60 days ²	
131	131	<p>TOOLS AND EQUIPMENT</p> <p>(Superseded) <i>Tools and equipment.</i> Check Department of the Army Supply Catalogs ORD 7 SNL G-310 (Antecar) and SNL G-691 (White) to see that all tools and equipment issued with and carried on the vehicle are present, in good condition, clean, and properly stowed or mounted. Any tools having bright or polished surfaces, mounted on outside of vehicle, should be treated to prevent glare or reflections. Tools with cutting edges should be sharp and their edges protected.</p>
135	135	<p>(Superseded) <i>Publications and Standard Form 97.</i> All vehicle and equipment manuals, lubrication order, and Standard Form 91 (Operator's Report of Motor Vehicle Accident) should be present, legible, and properly stowed.</p>
133	141	<p>(Superseded) <i>Modifications.</i> Check DA AGO Form 478 to determine whether all modification work orders have been properly completed. A list of current modification work orders is contained in SR 810-20-4. Enter any modifications or major unit assembly replacements made during this service on DA AGO Form 478.</p>
		<p>UNUSUAL CONDITIONS (Added)</p> <p>Maintenance operations and road tests as prescribed under usual conditions will apply equally under unusual conditions for all occasions except in extreme-cold weather. Intervals are necessarily shortened in extreme-cold weather servicing and maintenance. Vehicles subjected to salt-water immersion or complete submersion should be evacuated to ordnance maintenance unit as soon as possible after the exposure (par. 184.3).</p>

¹ The chart which appears in TM 9-810, 21 March 1947 (pages 55, 56, incl.), will be changed so that the "6,000 mile" and "1,000 mile" columns will read "6,000 miles or 4 months" and "1,000 miles or 60 days", as above.

² Whenever occur first.

Section XI

PARTS, SPECIAL TOOLS, AND EQUIPMENT FOR ORGANIZATIONAL MAINTENANCE

(Superseded)

23. General

Tools, equipment, and spare parts are issued to the using organization for maintaining the matériel. Tools and equipment should not be used for purposes other than prescribed and, when not in use, should be properly stored in the chest and/or roll provided for them.

23.1 Parts

Spare parts are supplied to the using organization for replacement of those parts most likely to become worn, broken, or otherwise unserviceable, provided such operations are within the scope of organizational maintenance functions. Spare parts, tools, and equipment supplied for the 4- to 6-ton 4x4 tractor truck (Autocar Model U-7144T, COE and White Model 444T, COE) are listed in Department of the Army Supply Catalogs ORD 7 SNL G-510 and ORD 7 SNL G-691 which are the authorities for requisitioning replacements.

23.2 Common Tools and Equipment

Standard and commonly used tools and equipment having general application to this matériel are authorized for issue by the ORD 7 catalog and by T/A and T/O&E.

23.3 Special Tools and Equipment

Certain tools and equipment, specially designed for organizational maintenance, repair, and general use with the matériel are listed in table III for information only. This list is not to be used for requisitioning replacements.

Table III. Special organizational tools and equipment

Item	Identifying number	Reference		Use
		Fig.	Par.	
ADAPTER, puller, shackle bolt.	41-A-18-241	10.12	136 and 137	Removal of spring pins. Used with PULLER - 41-P-2057.
EYE, lifting, engine, threaded end 1/2-13 NC-3. OD of eye 2 1/4 in, lgh overall 5 3/4 in.	41-E-029	10.12	56 and 57	Removal and installation of engine.
PULLER, pitman arm.	41-P-2051-35	10.12	143	Removal of pitman arm.
WRENCH, tubular, sgle end hex, size of opng 1 1/4 in, lgh overall 13 in.	41-W-3053-150	10.10	54	Removal and installation of oil-filter-case bolt.
WRENCH, wheel brg nut, dble end, net opngs 8 7/16 and 8 3/4 in.	41-W-2012-25	10.10	124	Removal and installation of rear - wheel - bearing nuts.
WRENCH, wheel brg nut, sgle end oct opng 4 1/4 in, lgh 3 1/4 in.	41-W-3625-126	10.12	134	Removal and installation of front - wheel - bearing nuts.

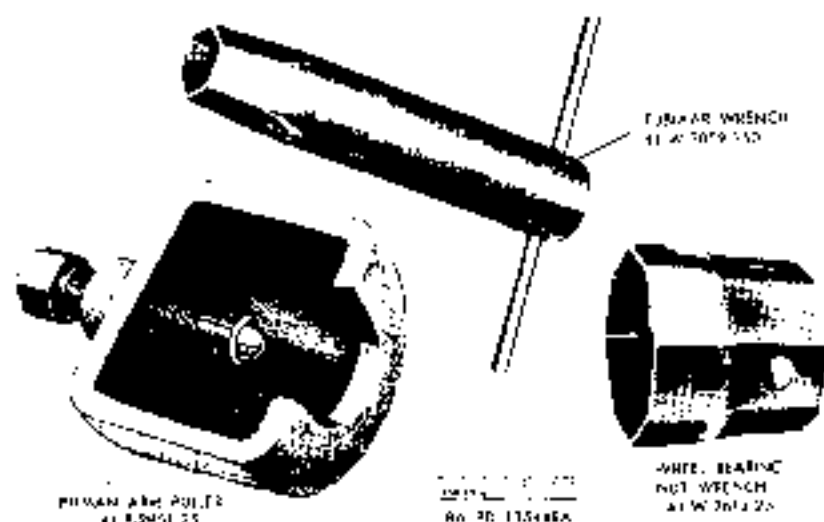

Figure 20.3 Special organizational tools.

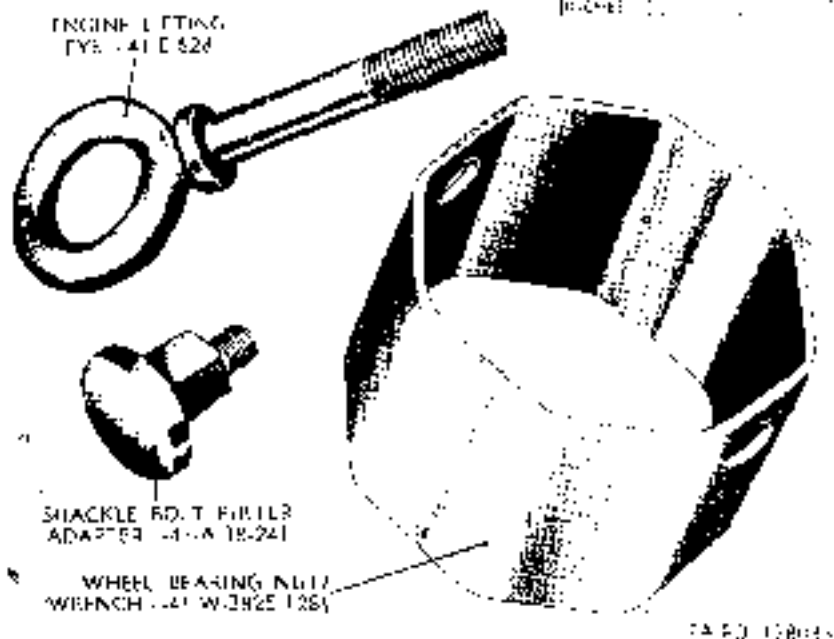

Figure 16.1 Continued.

51. Valve Tappet Adjustment

e. ADJUST TAPPETS (fig. 14). Beginning at either * * * screw lock nut. Insert feeler gage between the lower end of the valve stem and the valve tappet adjusting screw. Turn valve tappet * * * other valve tappets. Proper clearance for exhaust valves is 0.016 inch and for the intake valves 0.008 inch.

54. Oil Filter

a. MAINTENANCE.

(2) Adjust oil pressure (fig. 11). Remove the oil * * * to decrease pressure. Correct oil pressure is 26 psi at 1,500 rpm. When correct pressure * * * ascertained and corrected.

(4) Install oil filter element (fig. 17).

Note. After removing wrapper and before using the element, thoroughly remove any wax coating with a clean cloth and dry-cleaning solvent or volatile mineral spirits paint thinner. Unless the wax coating is completely removed, it will be dissolved by the passage of oil through the element and be carried into the oil lines where it will cause clogging.

Insert oil filter * * * floor board insert.

d. (Added) **REPLACEMENT OF OIL FILTERS.**

- (1) *Removal.* Remove cover and element as described in *a*(3) above. Using wrench 41-W-3059-150, remove the case bolt and lift off case from bracket. Scrape out case gasket from groove in bracket.
- (2) *Installation.* Place new case gasket in groove of bracket. Seat case carefully. Screw case bolt in tight, using wrench 41-W-3059-150. Install element and cover as described in *a*(4) above.

56. Removal

Note. Refer to paragraph 1c for information on coordination with an ordnance maintenance unit.

wa. (Superseded) Install engine lifting eyes 41-E-628 in engine (fig. 24). Remove cylinder head cap screw No. 16 from front cylinder head and cylinder head cap screw No. 15 from rear cylinder head. Install two engine lifting eyes 41-E-628 in place of the two cap screws removed. Attach a chain to engine lifting eyes and fasten hoist lift hook to chain.

wv. Remove engine from vehicle. Raise engine slowly * * * support bracket spacer.

57. Installation

a. (Superseded) **INSTALL ENGINE LIFTING EYES—41-E-628 IN ENGINE** (fig. 24). Refer to paragraph 56*wa.*

b. **POSITION ENGINE ON VEHICLE.** Install four new * * * parts and assemblies.

c. **INSTALL ENGINE SUPPORT BOLTS** (figs. 23 and 16). Install the 2 bolts * * * rear support extensions. Disconnect hoist from chain and remove chain and lifting eyes. Install the two cylinder head screws in place of the two eyes.

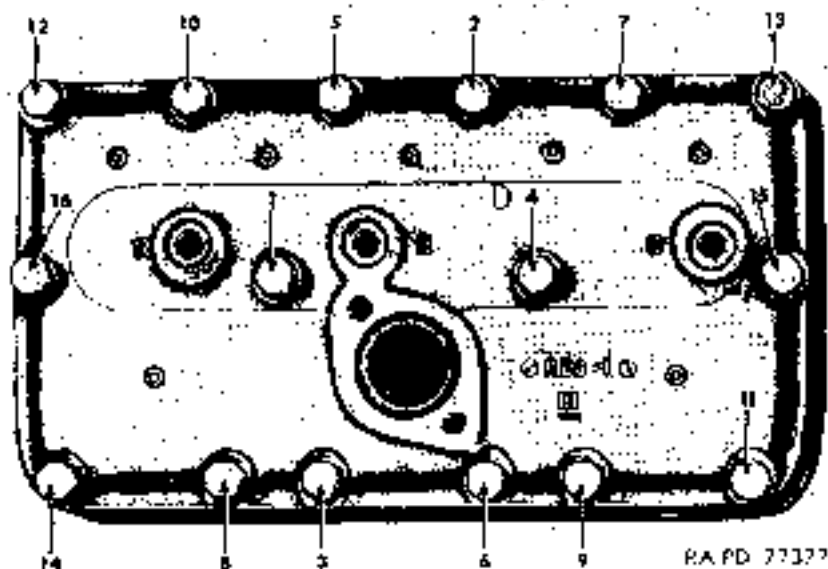

Figure 26. (Superseded.) Cylinder head cap screws.

60.1 Removal of Clutch and Pilot Bearing (Added)

Note. Refer to paragraph 16 for information on coordination with an ordnance maintenance unit.

- a. REMOVE TRANSMISSION. Refer to paragraph 94.
- b. REMOVE CLUTCH PLATE ASSEMBLY. Remove cap screws and shakeproof lock washers attaching pressure plate assembly to engine flywheel. Lift out pressure plate assembly.
- c. REMOVE CLUTCH DISK. Lift clutch disk from inside of engine flywheel.
- d. REMOVE CLUTCH PILOT BEARING. Remove clutch pilot bearing from seat in engine flywheel (fig. 27.1).

60.2 Installation of Clutch and Pilot Bearing (Added)

a. INSTALL PILOT BEARING (fig. 27.1). Care must be taken when installing clutch pilot bearing into engine flywheel. Bearing must be seated perfectly in order to maintain alignment of main drive gear, clutch disk, and pilot bearing. Pack bearing with lubricant (par. 16). Use a clutch pilot if available. If pilot is not available, carefully tap clutch pilot bearing into seat in flywheel with brass drift. Open side of bearing must face toward engine. Make certain bearing is started into flywheel evenly before forcing it fully into seat.

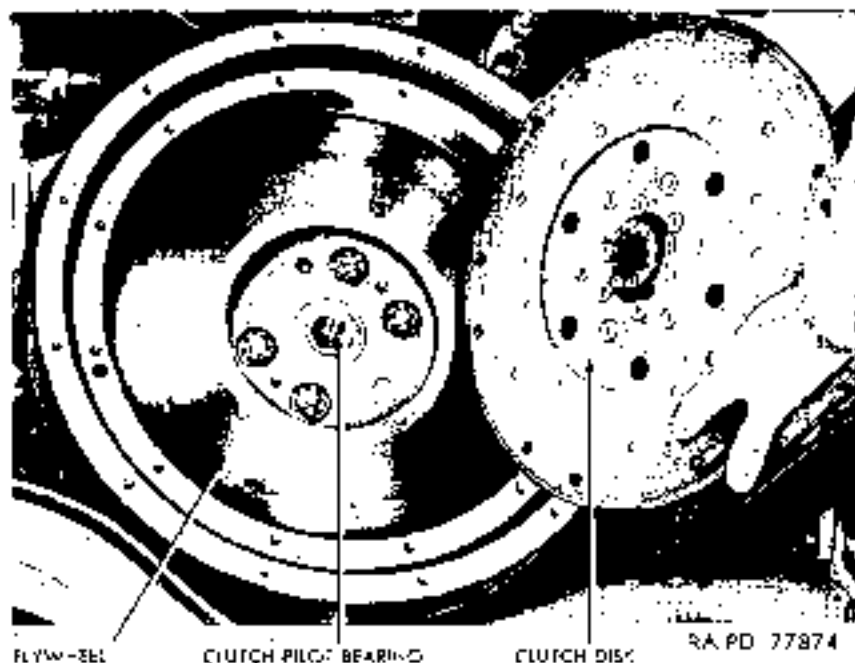

Figure 27.1 Clutch disk and pilot bearing.

b. **INSTALL CLUTCH DISK** (fig. 27.1). Place clutch disk against engine flywheel. Tapered ends of splines in disk hub must face away from flywheel. A pilot may be used for alignment of disk with clutch pilot bearing. If a pilot is not available, proper alignment can be obtained after installation of pressure plate assembly.

c. **INSTALL PRESSURE PLATE ASSEMBLY.** Lift pressure plate assembly into position against clutch disk, and install shakeproof lock washers and cap screws. Before fully tightening cap screws, bring the clutch disk into perfect alignment with clutch pilot bearing. A clutch pilot or a spare main drive gear can be used. Insert spline on main drive gear into spline in clutch disk hub, and push bearing surface on end of main drive gear into clutch pilot bearing. Clutch disk is not centered. Tighten cap screws to securely attach clutch pressure plate assembly to engine flywheel, and remove clutch pilot or spare main drive gear, if either was used.

d. **INSTALL TRANSMISSION.** Refer to paragraph 95.

72. Description and Maintenance

b. (Added) **MAINTENANCE.**

(1) *Draining.* To drain the cooling system thoroughly, open

the two petcocks, one on cylinder jacket above water pump, the other on radiator bottom outlet elbow.

Caution: Attach a "NO WATER" warning card to the steering wheel if cooling system is to remain empty.

- (2) *Filling.* Remove cover from radiator cap opening, and then remove radiator cap. Fill cooling system. Start engine and allow it to run until heat indicator reads 180° F. Shut off engine and add sufficient additional water to fill system.

Caution: Do not fill radiator when engine is overheated. Cylinder head or block may crack by cooling too rapidly. Allow engine to cool 1/4 hour, then run at idling speed while gradually filling radiator.

- (3) *Inspection.* Inspect all hose connections and hose connection clamps. Clamps must be tight, and hose connections must not leak. Inspect drain cocks on radiator outlet elbow and cylinder block for leakage. Examine all gaskets at water connections for leaks and tighten all bolts and nuts at these water connections.

- (4) *Flushing.* Start engine, run at idling speed, and pour water slowly into the radiator until the system is full (10 quarts). Run the engine at fast idle keeping the radiator covered if necessary until the coolant is heated to the normal operating temperature. Drain the system by removing the radiator cap and opening the drain cocks. Repeat the flushing operation until the drain water is clear. Allow the engine to cool and then clean all sediment and foreign matter from the radiator cap valves and the overflow valves. Blow insects and dirt from radiator core air passages with compressed air, blowing in a direction opposite to the normal flow of air. Use water, if necessary, to soften obstructions.

93. Description and Tabulated Data

a. DESCRIPTION (fig. 52). The transmission, which * * * on the countershaft.

* * * * *

94. Removal

Note. Refer to paragraph 1c for information on coordination with an ordnance maintenance unit.

* * * * *

98. Removal

Note. Refer to paragraph 1c for information on coordination with an ordnance maintenance unit.

105. Adjustment

a. (Superseded) TOE-IN TEST (fig. 57.1). With the front wheels in a straight-forward position, move the vehicle at least 3 feet forward to get the tires in free rolling condition. Place the alignment gage between the tires forward of the axle with both pendant chains barely touching the floor. Set the gage so that the pointer registers zero. Move the vehicle forward until the gage is back of the axle with the pendant chains barely touching the floor and read the gage. The amount the scale has moved in relation to the pointer will indicate the amount of wheel toe-in or toe-out. Since toe-out is never desirable, the gage is calibrated in inches for toe-in only.

b. TOE-IN ADJUSTMENT (fig. 58). Remove the cotter * * * threads per inch. When toe-in of $\frac{1}{8}$ = 1/16 inch is attained, position tube end to wheel assembly. Install tube end * * * and bolt nuts.

106. Removal

(fig. 58)

Note. Refer to paragraph 1c for information on coordination with an ordnance maintenance unit.

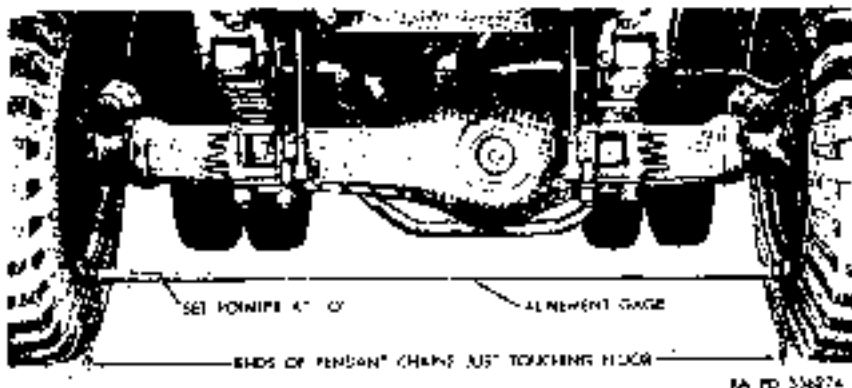

Figure 57.1 Toe-in test.

109. Removal (fig. 59)

Note. Refer to paragraph 1c for information on coordination with an ordnance maintenance unit.

134. Hubs and Wheel Bearings

b. ADJUSTMENT (figs. 81 and 82). Block wheels to * * * on rear axle.

Note. For removing wheel bearing nuts, use wheel bearing wrench 41-W-3825-128 for front wheels and wheel bearing wrench 41-W-2612-25 for rear wheels. Rotate wheel alternately * * * and remove blocks.

c. REMOVAL (figs. 81 and 82). Remove wheel (par. 133), * * * and nut lock.

Note. For removing wheel bearing nuts, use wheel bearing wrench 41-W-3825-128 for front wheels and wheel bearing wrench 41-W-2612-25 for rear wheels. If rear wheel, * * * from all parts.

d. INSTALLATION (figs. 81 and 82). Position brake drum * * * nut on shaft.

Note. For installing wheel bearing nuts, use wheel bearing wrench 41-W-3825-128 for front wheels and wheel bearing wrench 41-W-2612-25 for rear wheels.

Finish wheel installation * * * Install wheel (par. 133).

136. Front Springs

b. REMOVAL (fig. 83).

- (1) *Lubricate removal points.* Set propeller shaft brake. Remove dirt and grease from spring with dry-cleaning solvent or volatile mineral spirits paint thinner. Lubricate spring clips, clip nuts, and spring pins with preservative lubricating oil (special) to facilitate removal.

- (7) *Remove springs.* (Superseded) Lower vehicle until weight of spring is supported by axle. Screw the puller shackle bolt adapter 41-A-18-241 into the lubrication fitting hole of the spring pin. Using puller with the adapter for removal of each spring pin, pull spring pins out and remove spring.

137. Rear Springs

b. REMOVAL (fig. 84).

- (1) (Superseded) *Lubricate removal points.* Set propeller shaft brake. Remove dirt and grease from spring with dry-cleaning solvent or volatile mineral spirits paint thinner. Lubricate spring clips, clip nuts, and spring pins with preservative lubricating oil (special) to facilitate removal.

(5) *Remove draw keys* (fig. 83). Remove the two nuts and lock washers which secure the two draw keys at rear end of each spring, and drive out keys.

(6) *Remove spring.* (Superseded) Screw the puller shackle bolt adapter 41-A-18-241 into the lubrication fitting hole of the rear spring pin. Using puller with the adapter for removal of each spring pin, pull spring pins out. Remove cotter pin and nut from spring stud at inner side of front end of spring. Drive stud and tube out and remove spring.

c. **INSTALLATION** (fig. 84).

(2) *Install draw keys.* Wedge draw keys at each end against slotted side of pin and secure with the two nuts and lock washers at rear end of each spring.

Note. Use new draw keys and nuts.

143. Pitman Arm

(fig. 89)

a. **REMOVAL.** (Superseded) Remove cotter pin, nut, and lock washer which secure arm to tapered serrated end of lever shaft. Remove arm from shaft, using pitman arm puller 41-P-2951-35, and disconnect arm from drag link.

145. Windshield Wipers

e. (Added) **ADJUSTMENT.** A maximum wiper speed of not more than 60 cycles or 120 strikes per minute should be maintained at all times with the wiper blade and arm in position. If the wiper speed is not correct, remove the wiper blade, wiper arm, and control knob, and set the valve shaft to obtain a speed of 80 cycles per minute of wiper motor operation. After adjustment, install the control knob, wiper blade, and wiper arm.

156. Head Lights

c. (Added) AIMING ADJUSTMENT PROCEDURE (fig. 98.1).

- (1) Place unloaded truck on a smooth horizontal surface so that headlights are 25 feet away from a vertical wall or other vertical surface. The center line of the truck must be at right angles to the vertical surface.
- (2) Measure the height of the headlight center from the floor, and mark a horizontal line at this height on the vertical surface (line X—X, fig. 98.1).
- (3) Mark line A—A, below X—X, at one-twelfth the distance between line X—X and the floor.
- (4) Draw vertical lines B—B and C—C directly in front of each headlight.
- (5) Turn on headlights at main light switch and select high beam with dimmer switch. It is not necessary to make adjustment on low beam.
- (6) Loosen headlight mounting bolt nut on each headlight. Cover one headlight and aim the other so that the center of the zone of greatest intensity (hot spot) is centered at the intersection of lines A—A and B—B or A—A and C—C, depending on which headlight is being aimed. Tighten the headlight mounting bolt nut securely, making sure adjustment is not disturbed. Aim the other headlight in the same manner.
- (7) After each headlight is aimed separately, check both headlights simultaneously for conformity to line A—A.

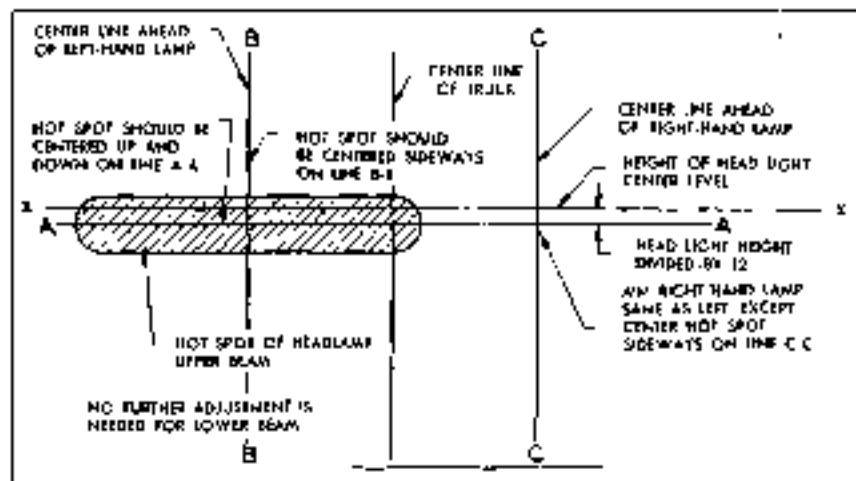

Figure 98.1 Head light adjustment.

RA PD 344344

Section XXXV.1

MAINTENANCE UNDER UNUSUAL CONDITIONS

(Added)

184.1 Extreme-Cold Weather Maintenance

Refer to TM 9-2855 for a general discussion of maintenance problems, the application of antifreeze compounds and Arctic-type lubrication, handling of storage batteries in extreme cold, and dewinterization procedure.

184.2 Extreme-Hot Weather Maintenance

a. **COOLING SYSTEM.** Thoroughly clean and flush the cooling system at frequent intervals and keep system filled to within a few inches of the overflow pipe with clean water when operating in extremely high temperatures. Formation of scale and rust in the cooling system occurs more often during operation in extremely high temperatures, therefore, corrosion-inhibitor compound should always be added to the cooling liquid. Avoid the use of water that contains alkali or other substances which may cause scale and rust formations. Use soft water whenever possible.

b. BATTERIES.

- (1) *Electrolyte level.* In torrid zones, check level of electrolyte in cells daily and replenish, if necessary, with pure, distilled water. If this is not available, rain or drinking water may be used. However, continuous use of water with high mineral content will eventually cause damage to the battery and should be avoided.
- (2) *Specific gravity.* Batteries operating in torrid climates should have a weaker electrolyte than for temperate climates. Instead of 1.260 specific gravity as issued, the electrolyte (sulphuric acid, sp. gr. 1.280) should be diluted with pure distilled water, as specified in TM 9-2857, to readings of 1.200 to 1.240 specific gravity. This is the correct reading for a fully-charged battery. This procedure will prolong the life of the negative plates and separators. Under this condition, a discharged battery should be recharged at about 1.160 specific gravity.
- (3) *Self-discharge.* A battery will self-discharge if left standing for long periods at high temperatures. This must be taken into consideration when operating in torrid zones. If necessary to park for several days, remove battery and store in a cool place.

Note. Do not store acid-type storage batteries near stacks of tires, as the acid fumes have a deleterious effect on rubber.

c. CHASSIS AND BODY.

- (1) In hot, dry climates, a careful watch must be kept for evidence of the presence of moths and termites.
- (2) In hot, damp climates, corrosive action on all parts of the vehicle will occur and will be accelerated in areas of high humidity and during the rainy season. Evidences will appear in the form of rust and paint blisters on metal surfaces and mildew or fungi mold on fabrics, leather, and unpainted surfaces.
- (3) Protect all exposed exterior painted surfaces from the atmosphere by touch-up painting and protect unfinished exposed metal surfaces by a film of engine lubricating oil (OE-10). Cables and terminals will be protected by ignition-insulation compound.
- (4) Make frequent inspections of idle, inactive vehicles. Remove corrosion from exterior surfaces with abrasive paper or cloth and apply a protective coating of paint, oil, or suitable rust preventive.

184.3 Maintenance After Fording

a. GENERAL. Although all of the vehicle unit housings are vented to atmospheric pressure, with the exception of the steering gear and front axle spindles, and seals are provided which prevent the free flow of water into the housings, it must be realized that, due to the necessary design of these assemblies, some water may enter, especially during submersion. It is advisable, therefore, that the following service be accomplished on all vehicles which have been exposed to some depth of water or completely submerged, especially in salt water, and precautions taken as soon as practicable to halt deterioration and avoid damage before the vehicle is driven extensively in regular road service.

b. CLEANING AND LUBRICATION.

- (1) *Body and chassis.* Drain and clean out body, engine, and tool compartment; clean all exposed unpainted parts and coat with a film of engine lubricating oil (OE-10). Cables and terminals will be protected by ignition-insulation compound. In the case of assemblies which have to be disassembled for cleaning, perform these operations as soon as the situation permits or refer to ordnance maintenance unit. Lubricate the chassis thoroughly as directed in the lubrication order. Do more than the usual lubrication job, making sure that lubricant is generously forced into each bearing to force out any water present. Wheels will be removed for bearing cleaning and repacking in every case.

- (2) *Transmission, transfer case, and axles.* Check the lubricant in the transmission, transfer case, and both axle housings. Should there be evidence that water has entered, drain the housings and flush them thoroughly with a half-and-half mixture of oil (OE-10) and dry-cleaning solvent or volatile mineral spirits paint thinner. Locate and remedy the cause of the leak. Refill to filler plug level with the correct grade of lubricant.
- (3) *Wheels and brakes.*
 - (a) Remove the front wheels and flush out the knuckle housings with a half-and-half mixture of oil (OE-10) and dry-cleaning solvent or volatile mineral spirits paint thinner. Refill to filler plug level with the correct lubricant. Remove rear wheels. Wash all wheel bearings thoroughly with dry-cleaning solvent or volatile mineral spirits paint thinner, after which repack, assemble, and adjust as outlined in paragraph 134.
 - (b) With wheels removed, dry out brake linings and clean rust and scum from brake drum face. Check wheel brake reservoirs for water.
- (4) *Steering gear.* Remove and disassemble steering gear. If the lubricant is contaminated, clean the housing thoroughly with a half-and-half mixture of oil (OE-10) and dry-cleaning solvent or volatile mineral spirits paint thinner. Assemble, refill with correct grade of lubricant, and adjust (par. 140).
- (5) *Engine crankcase and oil filter.* Drain and clean oil filter if necessary. Inspect crankcase for presence of water. If water or sludge is found, drain, flush, and refill with correct lubricant.
- (6) *Engine valve chamber.* Clean out engine valve chamber.

c. **BATTERY.** Check the battery for quantity and specific gravity of electrolyte to be sure no water entered through the vent caps. This is of special importance should the vehicle have been submerged in salt water. Add electrolyte and charge if necessary.

d. **DISTRIBUTOR.** Remove the distributor cap and check to determine if any water has entered the distributor. If any water is present, remove the distributor for cleaning (par. 82).

e. **ELECTRICAL CONNECTIONS.** Check all electrical connections for corrosion, particularly the bayonet-type connectors used in the various circuits.

f. **CARBURETOR BOWL, FUEL STRAINER, ETC.** Clean carburetor bowl, fuel strainer, pump, filter, tank, and lines as found necessary

after inspection. If water is found in the air cleaner, clear and change the oil.

g. ALUMINUM OR MAGNESIUM PARTS. If vehicle remains in salt water for any appreciable length of time, aluminum or magnesium parts which were exposed to the water will probably be unfit for further use and must be replaced.

h. CONDENSATION. Although most units are sealed and vented, the sudden cooling of the warm interior air upon submersion may cause condensation, with resultant collection of moisture within the cases or instruments. A period of exposure to warm air after fording should eliminate this fault. Cases which can be opened may be uncovered and dried.

184.4 Maintenance After Operation on Unusual Terrain

a. MUD. Thorough cleaning and lubrication of all parts affected must be accomplished as soon as possible after operation in mud, particularly when a sea of liquid mud has been traversed. Clean out radiator fins and interior of engine compartment. Repack wheel bearings if necessary. Clean, oil, and stow chains in vehicle.

b. SAND OR DUST. Replace badly "frosted" windshield and door glasses. Repaint surfaces blasted by sand. Clean engine compartment. Lubricate vehicle completely to force out lubricants contaminated by sand, salt, or dust. Air cleaners and fuel and oil filters must be cleaned at least daily. Engine and other exposed vents should be covered with cloth.

Section XXXVI (Rescinded)

PART THREE

(Added)

SHIPMENT AND LIMITED STORAGE AND DESTRUCTION TO PREVENT ENEMY USE

Section XXXVII. SHIPMENT AND LIMITED STORAGE

188. Domestic Shipping Instructions

a. **PREPARATION FOR SHIPMENT IN ZONE OF INTERIOR.** When shipping the 4- to 5-ton 4x4 tractor truck interstate or within the zone of interior, except directly to port of embarkation, the officer in charge of preparing the shipment will be responsible for furnishing vehicles to the carriers for transport in a serviceable condition, properly cleaned, preserved, painted, lubricated, etc. as prescribed in SB 9-4.

Note. For loading and blocking instructions of vehicles on freight cars, refer to paragraphs 100 and 101.

b. PREPARATION FOR SHIPMENT TO PORTS.

(1) *Inspection.* All used vehicles destined for oversea use will be inspected prior to shipment in accordance with TB ORD 385.

(2) *Processing for shipment to ports.* All vehicles destined to ports of embarkation for oversea shipment will be further processed in accordance with SB 9-4.

Note. Ports of embarkation will supplement any necessary or previously omitted processing upon receipt of vehicle.

c. **REMOVAL OF PRESERVATIVES FOR SHIPMENT.** Personnel withdrawing vehicles from a limited storage status for domestic shipment *must not remove preservatives*, other than to insure that the matériel is complete and serviceable. If it has been determined that preservatives have been removed, they must be restored prior to domestic shipment. The removal of preservatives is the responsibility of depots, ports, or field installations (posts, camps, and stations) receiving the shipments.

d. **ARMY SHIPPING DOCUMENTS.** Prepare all Army shipping documents accompanying freight in accordance with TM 38-705.

189. Limited Storage Instructions

a. GENERAL.

(1) Vehicles received for storage already processed for domestic shipment, as indicated on the vehicle processing

record tag (DA AGO Form 9-3), must not be reprocessed unless the inspection performed on receipt of vehicles reveals corrosion, deterioration, etc.

- (2) Completely process vehicle upon receipt directly from manufacturing facilities or if the processing data recorded on the tag indicates that vehicle has been rendered ineffective by operation or freight shipping damage.
- (3) Vehicle to be prepared for limited storage must be given a limited technical inspection and be processed as prescribed in SB 9-63. The results and classification of vehicle will be entered on DA AGO Form 461-5.

b. RECEIVING INSPECTIONS.

- (1) Report of vehicles received for storage in a damaged condition or improperly prepared for shipment will be reported on DD Form 6 in accordance with SR 745-45-5.
- (2) When vehicles are inactivated, they are to be placed in a limited storage status for periods not to exceed 90 days. Stand-by storage for periods in excess of 90 days will normally be handled by ordnance maintenance personnel only.
- (3) Immediately upon receipt of vehicles of storage, they must be inspected and serviced as prescribed in section X. Perform a systematic inspection and replace or repair all missing or broken parts. If repairs are beyond the scope of the unit and the vehicles will be inactivated for an appreciable length of time, place vehicles in a limited storage status and attach tags to the vehicles specifying the repairs needed. The reports of these conditions will be submitted by the unit commander for action by an ordnance maintenance unit.

c. INSPECTIONS DURING STORAGE. Perform a visual inspection periodically to determine general condition. If corrosion is found on any part, remove the rust spots, clean, paint, and treat with the prescribed preservatives.

Note. Touch-up painting will be in accordance with TM 9-2851

d. REMOVAL FROM LIMITED STORAGE.

- (1) If the vehicles are not shipped or issued upon expiration of the limited storage period, vehicles may either be processed for another limited storage period or be further treated for stand-by storage (vehicles inactivated for periods in excess of 90 days up to 3 years) by ordnance maintenance personnel.

- (2) If vehicles to be shipped will reach their destination within the scope of the limited storage period, they need not be reprocessed upon removal from storage unless inspection reveals it to be necessary according to anticipated in-transit weather conditions.

Note. All used vehicles that are to be issued to troops within the continental limits of the United States will be inspected prior to issue or shipment in accordance with TB ORD 385.

- (3) Deprocess vehicles when it has been ascertained that they are to be placed into immediate service. Remove all rust-preventive compounds as prescribed in section V and thoroughly lubricate as prescribed in section VI. Inspect and service vehicles as prescribed in section X.
- (4) Repair and/or replace all items tagged in accordance with b(3) above.

c. **STORAGE SITE.** The preferred type of storage for vehicles is under cover in open sheds or warehouses whenever possible. Where it is found necessary to store vehicles outdoors, the storage site must be selected in accordance with AR 700-105 and protected against the elements as prescribed in TB ORD 379.

190. Loading the 4- to 5-ton 4x4 Tractor Truck for Rail Shipment

a. PREPARATION.

- (1) When vehicles are shipped by rail, every precaution must be taken to see that they are properly loaded and securely fastened and blocked to the floor of car. All on-vehicle material (OVM) will be thoroughly cleaned, preserved, packed, and securely stowed in or on the vehicle for transit.
- (2) Prepare all vehicles for rail shipment in accordance with paragraph 188a. In addition, take the following precautions:
 - (a) Disconnect the truck battery to prevent its discharge by vandalism or accident. This is accomplished by disconnecting the positive lead, taping the end, and tying it back away from the battery.
 - (b) Apply the truck hand brake and place the transmission in neutral position after the vehicle has been finally spotted on the freight car. The vehicles must be loaded on the car in such a manner as to prevent the car from carrying an unbalanced load.
 - (c) Increase tire pressure slightly higher than normal except where shipment is to be exposed to extremely hot weather conditions.

5. TYPES OF CARS. Instructions contained herein pertain to the loading of vehicles in boxcars (cars equipped with side or side and end doors), gondola cars (an open top car having fixed sides, fixed or drop ends and solid bottom), and flatcars (cars with wooden floors laid over sills and without sides or ends but equipped with stake pockets).

C. METHOD OF LOADING VEHICLES ON FREIGHT CARS.

(1) *Flatcar loading.*

(a) When suitable hoisting equipment is not available for loading vehicles on or for subsequent unloading from a flatcar, an end ramp must be used in cases where the vehicle is not on a level with the flatcar deck. Vehicles on a warehouse platform or loading dock can be pivoted over spanning platforms alward a flatcar adjacent to the platform, then again pivoted into lateral position on the flatcar.

(b) When unboxed vehicles must be loaded from ground level, a ramp may be improvised (4) below) by borrowing railroad ties normally found stacked in railroad yards and by procuring necessary planking. An end ramp is shown in place in figure 111.

Note. Railroad ties alone, stacked without deck planking and not securely anchored, provide a very unstable ramp and must be rearranged upon each successive use. The torque action of the wheels of self-propelled vehicles will tend to collect and collapse a single stack of railroad ties and should, therefore, not be attempted except under conditions of extreme emergency.

(c) To accomplish loading, the vehicle is towed onto the improvised apron at base of ramp and unhitched. Using a cable laid along the center line of the flatcar, attached to vehicle, the vehicle is pivoted to point towards the ramp. A chock behind one wheel of the vehicle will prevent undesirable rearward travel and assist pivoting.

Caution: Personnel used to assist in pivoting the vehicle into position must be careful to avoid injury by the violent side-whipping liable to occur when strain is applied to the cable. Follow up forward movement of the vehicle by chocking behind one wheel on the ramp.

(d) For powering the towing cable, a vehicle with winch is spotted at right angles to the train. It is located at about the third or fourth flatcar to facilitate signaling and because of cable length limits. A single-sheave snatch block located between cars on the train center line will provide the necessary lateral pull. A vehicle

passing this point can be towed by a vehicle on the ground with personnel guiding its passage. A long tow cable from the towing vehicle will lessen the tendency of the towed vehicle to stray from the center line of the train.

Note. The snatch hook fastening chain must be lashed to an adjacent solidly fixed object or stake to offset the cross pull of the powered winch.

- (e) After the first vehicle is loaded on the flatcar, additional vehicles may be similarly hoisted aboard by passing the towing cable beneath the loaded vehicle. When a train of flatcars is being loaded, steel or wooden spanning platforms or bridges are used to cover the gaps between cars. Flatcar brake wheels must first be lowered to floor level to permit passage. A pair of improvised spanning platforms is shown in place in figure 111. These spanning platforms are moved along the train by hand as the vehicle advances.
- (f) The above method of train loading requires careful advance planning as to the order of loading, so that vehicles are arranged on each flatcar under prescribed methods and combinations.

(2) Gondola car loading.

- (a) Fixed-end gondola cars may be loaded only when hoisting facilities are available for initial loading and for unloading at destination. Hopper- or drop-bottom gondola cars without false flooring and hoisting facilities are not to be used for shipments of unboxed vehicles.
- (b) Drop-end gondola cars may be loaded exactly as described for flatcars ((1) above). Height of fixed sides is immaterial. Vehicles may progress through a gondola car by passing over the two inwardly-dropped ends and over spanning platforms. Vehicles selected to remain in a gondola car are first moved to the *closed* end of the car, then spread out for blocking after the remaining end is closed and latched.

Note. Do not block vehicle flush against ends of gondola car. When ordering gondola cars, specify inside width required as some may be received with gussets along the inner sides which affect clearance.

(3) Boxcar loading.

- (a) End-door boxcars are spotted with the door end toward the ramp and loaded as described for flatcars ((1) above) except that loading must be accomplished by

pushing the vehicle or towing by cable and block through the side door (fig. 113). When the height of the vehicle to be loaded is close to the inside height limits of the boxcar, it will be necessary to first load the vehicle on an adjacent flatcar. The two end doors must be opened *before* the flatcar is coupled to the door end of the boxcar.

Note. When ordering end-door boxcars, it must be remembered that some automobile boxcars may be received with an overhead built-in rack which affects inside height calculations. Specify inside height required. Keep open end doors clear of traffic on adjacent tracks.

- (b) Side-door boxcars are provided with either single or double rolling doors at each side and **must** be loaded from a platform of about the same level as the boxcar floor or from an adjacent flatcar. Automobile cars of this type have large side door openings and present less difficulty in loading. However, ordinary boxcars may require the use of roller automobile jacks to maneuver the vehicle into place. Steel plates or spanning platforms must be used to bridge the gap between platform and car.

Note. In emergencies when no roller jack is available, the vehicles may be moved sideways by means of an ordinary jack canted against the axle from the floor. Wetting both floor of the car and bridging will reduce the friction of the tires.

(4) *Loading ramp.*

- (a) A ramp for end-loading of vehicles on open-top freight cars may be improvised when no permanent ramps or hoisting facilities are available. A ramp suitable for the loading of most ordnance items is shown in figures 111 and 112. For loading the 4- to 6-ton 4x4 tractor truck, the width of the ramp may be reduced to two double-plank runways, each cleated together. Length of planking must be determined with consideration to underchassis clearance, in order to clear the hump at upper end of ramp.

Caution: Personnel guiding the vehicle up the ramp must exercise care when working close to the edges of the ramp planking.

- (b) The car bearing the ramp must be securely blocked against rolling, particularly when the car brakes are not applied as in train loading. Successive cars must remain coupled and be additionally chocked at several points along the train when ground towing of vehicles aboard the train is being effected.

- (c) Whenever the freight cars are not on an isolated track or blocked siding, each end approach to the train must be posted with a blue flag or light to advise that men are at work and that the siding may not be entered beyond those points.
- (d) Upon completion of the loading operation, the ramp planks and bridging devices should be loaded on the train for use in unloading operations. Random sizes of timbers used in building the approach apron up to rail level should be included. All materials should be securely fastened to the car floors, after vehicles are blocked in place, and entered upon the bill of lading (B/L). Railroad ties borrowed for the operation should not be forwarded to the unloading point unless specifically required and only with the consent of the owner.

d. **LOADING RULES.** For general loading rules pertaining to rail shipment of ordnance vehicles, refer to TB 9-OSSC-G.

Warning: The height and width of vehicles when prepared for rail transportation must not exceed the limitations indicated by the loading table as prescribed in AR 700-105, section II. Whenever possible, local transportation officers must be consulted about the limitations of the particular railroad lines to be used for the movement to avoid delays, danger, or damage to equipment.

191. Blocking the 4- to 5-ton 4x4 Tractor Truck for Rail Shipment

a. **GENERAL.** All blocking instructions specified herein are minimum and are in accordance with the Association of American Railroads "Rules Governing the Loading of Commodities on Open Top Cars." Additional blocking may be added as required at the discretion of the officer in charge. Double-headed nails may be used if available, except in the lower piece of two-piece cleats. All item reference letters given below refer to the details and locations as shown in figure 114.

Note: Any loading methods or instructions developed by any source which appear in conflict with this publication or existing loading rules of the carriers must be submitted to the Chief of Ordnance, Washington 25, D. C. for approval.

b. **BRAKE WHEEL CLEARANCE "A."** Load trucks on flatcars with a minimum clearance of at least 4 inches below and 6 inches above, behind, and to each side of the brake wheel (fig. 114). Increase clearance as much as is consistent with proper location of load.

Note: Vehicles should be laterally spotted on flatcar so that wheels are centrally positioned between stake pockets in order that wheel straining "G" (A below) provides uniform cross wiring.

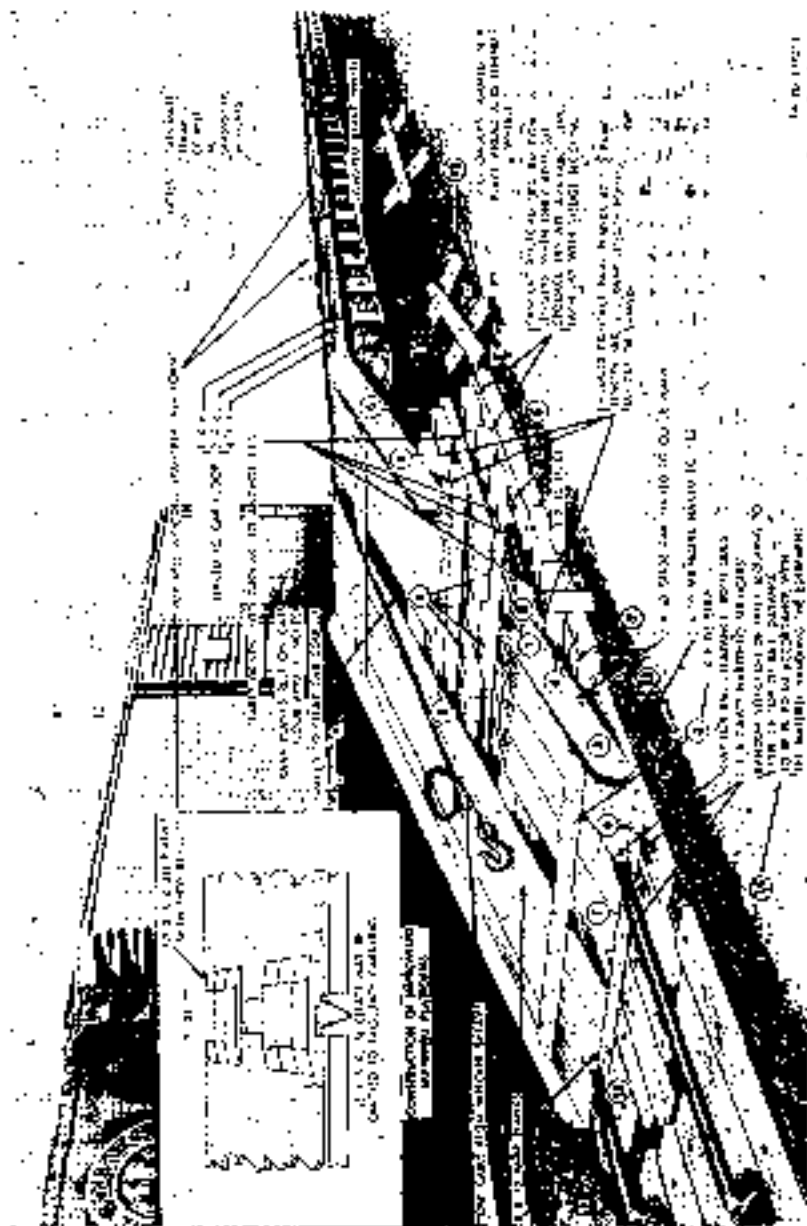

Figure 111. Construction of temporary loading ramp and spanning platform.

NOTES

- 1 RAMP WIDTH IS OF CAPACITY OF LARGEST END (ACING) (RAMP) LAR FOR LESSER LOADS, REDUCE NUMBER OF RAMP PLANES
- 2 W/OUT DELAY, END BY TRAIL OF MATERIAL BEING LOADED
- 3 FOR LOADING, END OF RAMP SHOULD BE STRENGTHENED OR SHORT W/OUT RELEASE MATERIAL IN RAMP PLANES MAY BE SHIFTER
- 4 CAUTION: WHEN RAMP IS TOO SHORT, UNDERPINNING OF MATERIAL WILL STRIKE END OF RAMP FOR W/OUT RAMP
- 5 FOR RAMP CENTER MAY BE PULLED UP TO THE CAR COUPLER TO AVOID INJURY TO MEN, LOADING PERSONNEL
- 6 FOR LOADING PERSONNEL APPROACH END OF RAMP MUST BE BLOCKED UP TO AVOID SPRING OF RAMP
- 7 THIS APPROACH IS NEARLY AVAILABLE TO RAMP END TO RAMP AND MUST BE BLOCKED UP TO AVOID LOADING
- 8 IN RAMP LOADING, END OF RAMP MUST BE BLOCKED UP TO AVOID INJURY TO MEN, LOADING PERSONNEL
- 9 WHEN LOADING BY WHEELER CAR, WITH PULL AT 90 DEGREES TO TRAIN, USING A 5-BASE PLATING AT RAMP OF PULL MUST BE LAINED TO ADJACENT RAIL CAR, OR OTHER FIXED POINT

RA 60 117513

PART NO	BILL OF MATERIALS FOR RAMP AS ILLUSTRATED				THICKNESS
	QUANTITY	PART NAME	LENGTH	WIDTH	
1	4	RAMP PLANKS	27'	10"	1/2"
2	8	WOOD ENDS	24"	5 1/2"	3/4"
3	2	1 1/2" x 2" PL	8 1/2"	8 1/2"	1/2"
4	8	1 1/2" x 2"	18"	8 1/2"	1/2"
5	1	1 1/2" x 2"	20"	8 1/2"	1/2"
6	1	RAILROAD TIES	11'	6 1/2"	5 1/2"
7	AS BLDG	FULLS	AS BLDG	10 1/2"	2 1/2"
8	AS REQD	W/OUT TO BE	11'	10 1/2"	2 1/2"
9	1	STRIPPER PILE	21'	4 1/2"	4 1/2"
10	1	STRIPPER PILE	21'	6 1/2"	5 1/2"
11	1	STRIPPER PILE	11'	6 1/2"	1 1/2"
12	1	STRIPPER PILE	AS BLDG	4 1/2"	4 1/2"
13	AS REQD	STRIPPER	AS BLDG	10 1/2"	2 1/2"
14	AS REQD	STRIPPER	AS REQD	10 1/2"	2 1/2"

Figure 112. Legend for figure 111.

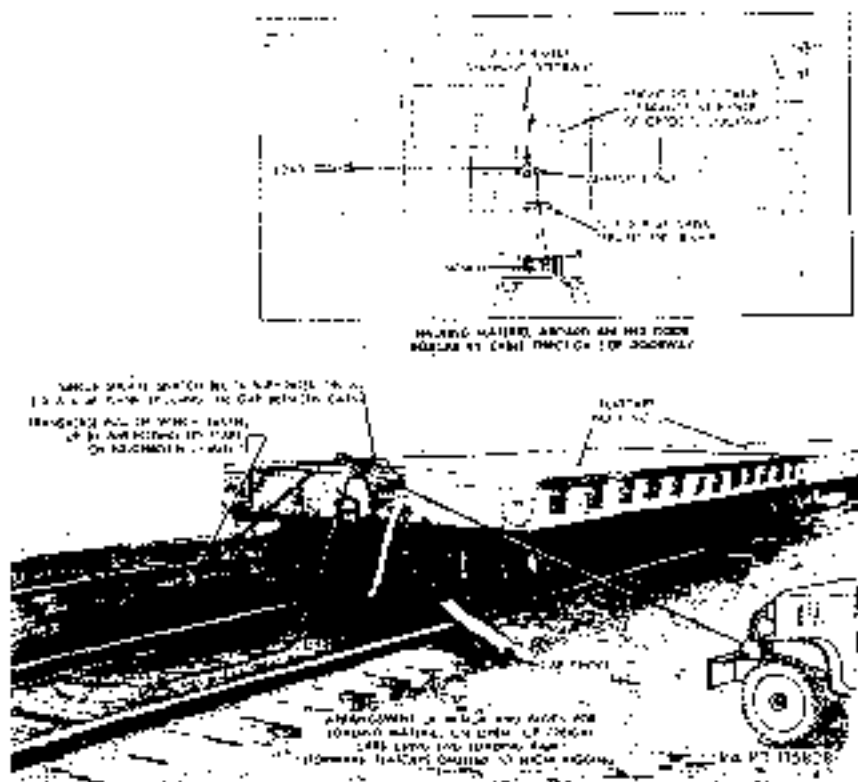

Figure 113. Method of powering the towing cable

c. **CHOCK BLOCKS "B"** (6 x 8 x 24 INCHES, 12 REQUIRED PER TRUCK). Locate the 45-degree face of blocks against the front and rear of each wheel. Blocks are to be positioned in such a manner as to allow flush application of wheel side cleats "D" (e below) when nailed to chock blocks. Nail heel of blocks to car floor with three forty-penny nails and toenail both sides of blocks to car floor with two forty-penny nails each.

Note. Chock blocks may be cut from timbers (or railroad ties, when available) as shown in figure 115.

d. **CUSHIONING MATERIAL "C."** Locate suitable cushioning material, such as waterproof paper, burlap, etc., between tires and cleats "D." The cushioning material should protrude beyond cleats "E" at floor and above cleats "D."

e. **WHEEL SIDE CLEATS "D"** (1 x 8 x 46 INCHES, FOUR REQUIRED PER TRUCK). Locate and nail cleats "D" to chock blocks "B" with four ten-penny nails at each end.

f. FLOOR SIDE CLEATS "E" (2 X 4 X 38 INCHES, EIGHT REQUIRED PER TRUCK). Locate two floor side cleats against each wheel side cleat "D" with cushioning material protruding underneath cleats. Nail lower cleats to car floor with four thirtypenny nails and upper cleats to lower cleats and car floor with four forty-penny nails.

g. CROSS CLEATS "F" (2 X 4 INCHES, LENGTH TO SUIT, FOUR REQUIRED PER TRUCK). Locate two cleats across the top of the front chock blocks and two cleats across the rear chock blocks. Nail lower cleats to the top of chock blocks with two thirtypenny nails at each end. Nail upper cleats to the lower cleats and top of chock blocks with two forty-penny nails, staggered at each end.

h. WHEEL STRAPPING "G" (NO. 8 GAGE BLACK ANNEALED WIRE, LENGTH TO SUIT).

Note. For gondola or boxcar loading, wheel strapping will not be required.

- (1) *Front wheels.* Form a cable by twist-tying four strands of wire together. Pass cable through ventilating hole in upper part of front wheel slightly *forward* of center and out through adjacent ventilating hole. Pass the other end of the cable through a stake pocket *rearward* of front wheel. Form a 6-inch loop in the end by winding each of the four wires tightly around the cable a few turns. Position the loop midway between the wheel and stake pocket. Pass the free end of the cable through the loop, hand tighten, and again wind the ends of the wires around their cable lightly to form another loop. Place a random length 2 x 2-inch cleat between cables. Insert a tightening tool at center of cable and twist just taut enough to remove all slack. Withdraw tightening tool, leaving cleat in cable to maintain an aperture for tightening cable during transit. Form another cable and pass through ventilating hole at upper part of front wheel slightly *rearward* of center and out through adjacent ventilating hole, crossing initial cable. Pass other end of cable through a stake pocket *forward* of front wheel. Complete and twist-tie as described above. Repeat above operations for the other front wheel.
- (2) *Rear wheels.* Each outside rear wheel will be cross-cabled to stake pocket as prescribed for the front wheel ((1) above) (fig. 114).

Note. Cables are passed through stake pockets in such a manner that the cable loop lays against the car frame. A short stake driven into the stake pocket will protect the cable loop from chafing and loosening. (This stake is omitted in fig. 114.) When slackers which are provided with well-type stake pockets are received, a loop of

The strapping cable is passed through the stake pocket and a short piece of wood, about 2 by 1 by 18 inches, is inserted in the loop below the stake pocket. Subsequent tightening of the strapping will cause the cable to draw the wooden block securely against the bottom of the stake pocket.

i. **AXLE STRAPPING "H."** Locate two pieces of 1½ x 0.035-inch hot-rolled steel strapping over each axle close to brakes. Coil strapping around steel anchor plates as shown in figure 114. Secure by nailing anchor plates to car floor with not less than six twenty-penny nails (double-headed nails preferred). As an alternate method of securing axles, form and substitute a cable "G," consisting of four strands of No. 8 gage black annealed wire or wires of equivalent strength, at each location for steel strapping "H." Pass cables over axle and around wooden cleats "J" (2 x 4 x 18 inches). Locate cleats lengthwise of car and nail to car floor with four thirty-penny nails in each cleat. As in *h*(1) above, join both ends of cable together, twist, and tighten with rod or bolt just taut enough to take up slack (fig. 114 inset).

Section XXXVIII

DESTRUCTION OF MATERIEL TO PREVENT ENEMY USE

192. General

a. Destruction of the vehicle and equipment, when subject to capture or abandonment in the combat zone, will be undertaken by the using arm only when, in the judgment of the unit commander concerned, such action is necessary in accordance with orders of, or policy established by, the army commander.

b. The information which follows is for guidance only. Certain of the procedures outlined require the use of explosives and incendiary grenades which normally may not be authorized items for the vehicle. The issue of these and related materials, and the conditions under which destruction will be effected, are command decisions in each case, according to the tactical situation. Of the several means of destruction, those most generally applicable are—

- Mechanical— Requires ax, pick mattock, sledge, crowbar, or similar implement.
- Burning — Requires gasoline, oil, incendiary grenades, or other inflammables.
- Demolition — Requires suitable explosives or ammunition.
- Gunfire — Includes artillery, machine guns, rifles using rifle grenades, and launchers using antitank rockets. Under some circumstances hand grenades may be used.

VIEW OF WHEELS WITH BUSHINGS AND STRAP

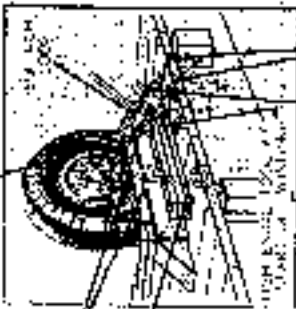

3-WOODEN RINGS ARE SLID ON WHEELS IN ORDER TO HOLD STRAPS IN POSITION. THIS METHOD OF STRAPPING WILL HOLD WHEELS IN POSITION AT ALL TIMES.

WHEELS TO BE STRAPPED

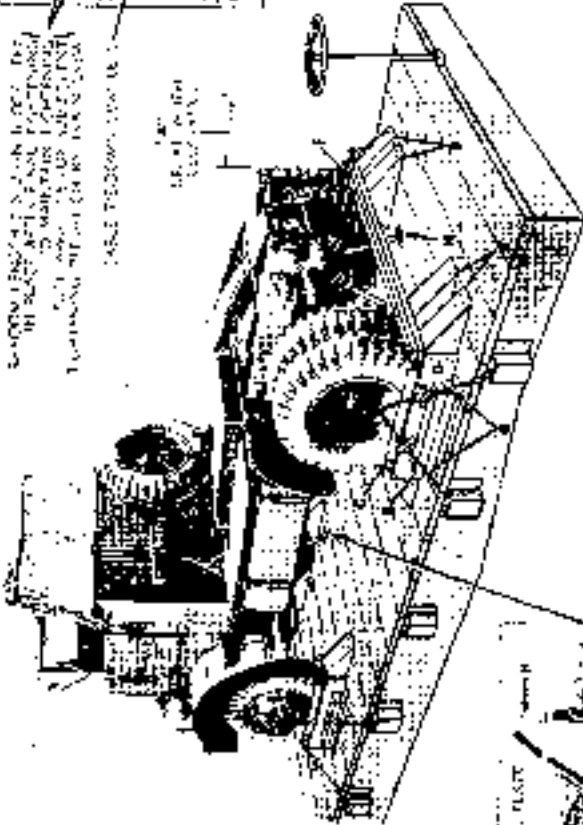

AS SHOWN IN FIG. 1, THE WHEELS ARE STRAPPED TO THE CHASSIS IN ORDER TO HOLD THEM IN POSITION AT ALL TIMES. THIS METHOD OF STRAPPING WILL HOLD WHEELS IN POSITION AT ALL TIMES.

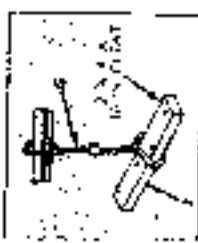

DETAIL 1
ALTERNATE METHOD
OF STRAPPING WHEEL

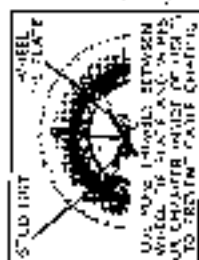

DETAIL 2
METHOD OF STRAPPING
SOLID DISK WHEELS

US WAVE THROUGH BETWEEN WHEELS TO HOLD STRAP IN POSITION AT ALL TIMES. THIS METHOD OF STRAPPING WILL HOLD WHEELS IN POSITION AT ALL TIMES.

DETAIL 3
METHOD OF STRAPPING
SOLID DISK WHEELS



DETAIL 2
METHOD OF STRAPPING ANCHOR PLATE WHEELS FOR TRUCK CAR BLOCKING

DETAIL 1
METHOD OF STRAPPING
WHEELS

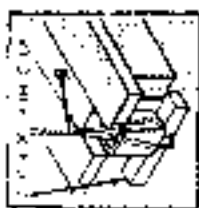

DETAIL 3
METHOD OF STRAPPING
ANCHOR PLATE
WHEELS

Figure 11. Method of blocking 1-1/2 ton motor trucks for rest alignment.

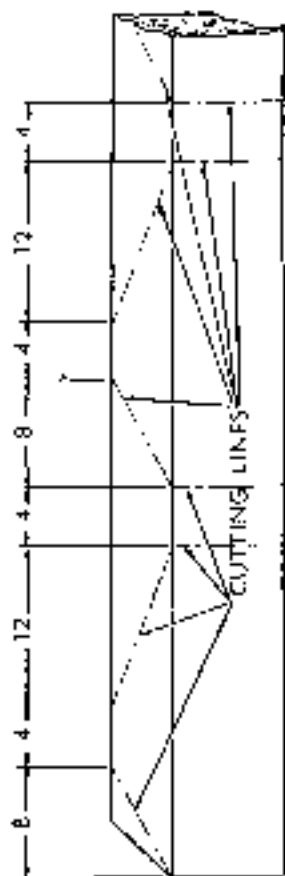

METHOD OF MARKING TIMBER
FOR CUTTING CHOCK BLOCKS

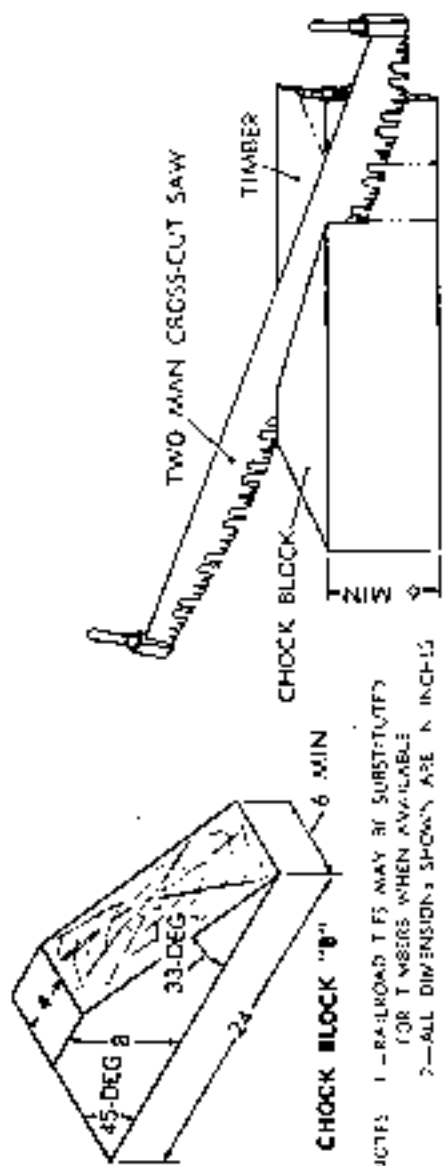

CHOCK BLOCK "B"

NOTES 1—RAILROAD TIES MAY BE SUBSTITUTES

FOR TIMBERS WHEN AVAILABLE

2—ALL DIMENSIONS SHOWN ARE IN INCHES

RA PD 115924B

Figure 376. Cutting chock blocks from timbers.

In general, destruction of essential parts, followed by burning, usually will be sufficient to render the matériel useless. However, selection of the particular method of destruction requires imagination and resourcefulness in the utilization of the facilities at hand under the existing conditions. Time is usually critical.

c. If destruction to prevent enemy use is resorted to, the matériel must be so badly damaged that it cannot be restored to a usable condition in the combat zone either by repair or cannibalization. Adequate destruction requires that all parts essential to the operation of the matériel, including essential spare parts, be destroyed or damaged beyond repair. However, when lack of time and personnel prevents destruction of all parts, priority is given to the destruction of those parts most difficult to replace. Equally important, the same essential parts must be destroyed on all like matériel so that the enemy cannot construct one complete unit from several damaged ones.

d. If destruction is directed, due consideration should be given to —

- (1) Selection of a point of destruction that will cause greatest obstruction to enemy movement and also prevent hazard to friendly troops from fragments or ricocheting projectiles which may occur incidental to the destruction.
- (2) Observance of appropriate safety precautions.

193. Destruction of the 4- to 5-ton 4x4 Tractor Truck

a. METHOD NO. 1—BY BURNING.

- (1) Remove and empty portable fire extinguishers.
- (2) Puncture fuel tank as near the bottom as possible, collecting gasoline for use as outlined in (5) below.
- (3) Using an ax, pick mattock, sledge, or other heavy implement, smash all vital elements such as distributor, carburetor, generator, air compressor, ignition coil, fuel pump, spark plugs, air cleaner, lights, trailer sockets, trailer brake couplings, brake valves, instruments and controls. If time permits and a sufficiently heavy implement is available, smash the engine cylinder block and head, crankcase, and transmission.
- (4) Slash tires. Exercise care to prevent injury from inflated tires blowing out while being slashed. Whenever practicable, it is usually preferable to deflate tires before slashing.
- (5) Pour gasoline and oil over the wheels, brakes, and elec-

trical wiring and then ignite. If gasoline and oil are not available, use incendiary grenades. If gasoline, oil, and incendiary grenades are available, a combination of them may be used. Elapsed time: about 6 minutes.

Caution: Due consideration should be given to the highly inflammable nature of gasoline and its vapor. Carelessness may result in painful burns.

b. METHOD NO. 2—WITH DEMOLITION MATERIALS.

- (1) Remove and empty portable fire extinguishers.
- (2) Puncture fuel tank.
- (3) Prepare two 2-pound charges of explosive (two 1-lb. blocks of TNT or equivalent per charge). Set one charge on top of the clutch housing and the other on the left side of the engine, as low as possible. Connect the two charges for simultaneous detonation with detonating cord. Provide for dual priming to minimize the possibility of a misfire. For priming, either a nonelectric blasting cap crimped to at least 5 feet of safety fuse (safety fuse burns at the rate of 1 foot in 30 to 45 seconds; test before using) or an electric blasting cap and firing wire may be used. The safety fuse, which contains black powder, and blasting caps must be protected from moisture at all times. The safety fuse may be ignited by a fuse lighter or a match; the electric blasting cap requires a blasting machine or equivalent source of electricity.

Caution: Keep the blasting caps, detonating cord, and safety fuse separated from the charges until required for use.

Note: For the successful execution of methods of destruction involving the use of demolition materials, all personnel concerned will be thoroughly familiar with the pertinent provisions of FM 5-35. Training and careful planning are essential.

- (4) Destroy the tires by placing an incendiary grenade under each tire. The detonation of the explosive charges should be delayed until the incendiary fires are well started. This will prevent the fires from being extinguished by the blast when the charges are detonated.
- (5) Detonate the charges. If primed with nonelectric blasting cap and safety fuse, ignite and take cover. If primed with electric blasting cap, take cover before firing. Elapsed time: about 6 minutes.

c. METHOD No. 3—BY GUNFIRE.

- (1) Remove and empty portable fire extinguishers.
- (2) Puncture fuel tank.
- (3) Destroy the tires as in method No. 1 or 2 above.
- (4) Destroy the vehicle by gunfire using artillery and machine guns, by rifles using rifle grenades, or by launchers using antitank rockets. Fire on the vehicle aiming at the engine, axles, wheels, and body. Although one well placed direct hit may destroy the vehicle, several hits are usually required for complete destruction unless an intense fire is started, in which case the vehicle may be considered destroyed. Elapsed time: about 6 minutes.

Caution: Firing at ranges of 500 yards or less should be from cover.

REFERENCES

(Rescinded)

APPENDIX

(Added)

REFERENCES

1. Publication Indexes

The following publication indexes and lists of current issue should be consulted frequently for latest changes or revisions of references given in this appendix and for new publications relating to the matériel covered in this manual:

Index to Administrative Publications.	SR 310-20-5
Index of Army Motion Pictures and Film Strips	SR 110- 1-1
Index of Training Publications.	SR 310-20-3
Index of Blank Forms and Army Personnel Classification Tests.	SR 310-20-6
Index of Technical Manuals, Technical Regulations, Technical Bulletins, Supply Bulletins, Lubrication Orders, Modification Work Orders, Tables of Organization and Equipment, Reorganization Tables, Tables of Allowances, Tables of Organization, and Tables of Equipment.	SR 310-20-4
Introduction and Index (supply catalogs)	ORD 1
Military Training Aids	FM 21-8

2. Supply Catalogs

The following catalogs of the Department of the Army Supply Catalog pertain to this matériel:

a. AMMUNITION.

Ammunition, rifle, carbine, and automatic gun ORD 11 SNL T-1

b. ARMAMENT.

Gun, machine, cal. .30, Browning, M1919A1, fixed and flexible; M1919A5, fixed; and M1919A6; and Ground Mounts. ORD (*) SNL A-6

Gun, machine, cal. .50, Browning, M2, heavy barrel, fixed and flexible and Ground Mounts. ORD (*) SNL A-89

(*) See ORD 1 Introduction and Index, for published catalogs of the Ordnance Section of the Department of the Army Supply Catalog.

Mount, truck, M32, M36, M37, M37A1, M37A2, M37A3, and M50; Mount, ring M40, M49A1, M49A1C, and M49C.	ORD (*) SNL A-55, Sec 19
Mount, truck, M61	ORD (*) SNL A-55, Sec 55

c. DESTRUCTION TO PREVENT ENEMY USE.

Land mines and fuzes, demolition material and ammunition for simulated artillery and grenade fire.	ORD 11 SNL R-7
--	----------------

d. MAINTENANCE AND REPAIR

Cleaner, preservatives, lubricants, reveal fluids, special oils, and related maintenance materials.	ORD 3 SNL K 1
Items of soldering, metallizing, brazing, and welding materials; gases and related items.	ORD 3 SNL K-2
Lubricating equipment, accessories, and related dispensers.	ORD (*) SNL K-3
Tool-sets (common), specialists' and organizational.	ORD 6 SNL C-27, Sec 2

e. VEHICLE.

Truck, 4- to 5-ton, 4 x 4, COE, tractor (Autocar Model U-7144T).	ORD (*) SNL G-610
Truck, 4- to 5-ton, 4 x 4 tractor (White Model 444T, COE).	ORD (*) SNL G-691

3. Forms

The following forms pertain to this matériel:

Standard Form 91, Operator's report of motor vehicle accident.
Standard Form 91A, Transcript of operator's report of motor vehicle accident.
Standard Form 93, Report of investigating officer.
Standard Form 94, Statement of witness.
DA Form 30b, Report of claims officer.
DA AGO Form 9-3, Processing record for storage and shipment.
DA AGO Form 9-4, Vehicular storage and servicing record.
DA AGO Form 9-68, Spot check inspection report for wheeled and half-track vehicles.
DA AGO Form 9-74, Motor vehicle operator's permit.
DA AGO Form 9-75, Daily dispatching record of motor vehicles.
DA AGO Form 348, Driver qualification record.
DA AGO Form 460, Preventive maintenance roster.

* (*) See ORD 1, Introduction, and Index, for published status of the reference sections of the Department of the Army Supply Catalog.

- DA AGO Form 461, Work sheet for wheeled and half track vehicles:
 - Preventive maintenance service and technical inspection.
 DA AGO Form 461-5, Limited technical inspection.
 DA AGO Form 468, Unsatisfactory equipment report.
 DA AGO Form 478, MWO and major unit assembly replacement records and organizational equipment file.
 DA AGO Form 811, Work request and job order.
 DA AGO Form 811-1, Work request and hand receipt.
 DD Form 6, Report of damaged or improper shipment.
 DD Form 110, Vehicle and equipment operational record.
 DD Form 317, Preventive maintenance service due.

4. Other Publications

The following explanatory publications contain information pertinent to this matériel and associated equipment:

a. AMMUNITION.

Regulations for Firing Ammunition for Training, SR 385-310 & Target Practice, and Combat.

b. ARMAMENT.

Browning Machine Guns Caliber .30, M1917A1, M1919A1, and M1919A6. FM 23-55

Browning Machine Gun, Caliber .50, HB, M2. FM 23-45

Machine Gun Mounts for Trucks. TM 9-224

c. CAMOUFLAGE.

Camouflage. TM 5-267

Camouflage, Basic Principles. FM 5-20

Camouflage of Vehicles. FM 5-203

d. DECONTAMINATION.

Decontamination. TM 3-229

Decontamination of Armored Force Vehicles. FM 17-59

Defense Against Chemical Attack. FM 21-40

e. DESTRUCTION TO PREVENT ENEMY USE.

Explosives and Demolitions. FM 5-25

f. GENERAL.

Cooling Systems: Vehicles and Powered Ground Equipment. TM 9-2858

Driver Selection, Training, and Supervision: Wheeled Vehicles. TM 21-300

Driver's Manual. TM 21-305

Instruction Guide: Operation and Maintenance of Ordnance Matériel in Extreme Cold (0° to -65° F.). TM 9-2856

Motor Transport	FM 23-10
Motor Vehicles	AR 700-105
Mountain Operations	FM 70-10
Operations in Snow and Extreme Cold	FM 70-15
Precautions in Handling Gasoline	AR 850-20
Preparation of Ordnance Matériel for Deep-water Forging.	TM 9-2853
Principles of Automotive Vehicles	TM 9-2790
Reports of Accident Experience	SR 385-10-40
Spark Plugs	TB ORD 313
Storage Batteries—Lead-Acid Type	TM 9-2857
Supplies and Equipment—General: Unsatisfactory Equipment Report.	SR 700-45-5
g. MAINTENANCE AND REPAIR.	
Maintenance Responsibilities and Shop Operation	AR 750-5
Cleaning, Preserving, Sealing, and Related Materials Issued for Ordnance Matériel.	TM 9-859
Hand, Measuring, and Power Tools	TM 10-590
Lubrication Order	LO 2-815
Maintenance and Care of Hand Tools	TM 9-867
Maintenance and Care of Pneumatic Tires and Rubber Treats.	TM 31-200
Motor Vehicle Inspection and Preventive Maintenance Services.	TM 37-2810
Painting Instructions for Field Use	TM 9-2851
Preparation of Ordnance Matériel for Deep-Water Forging.	TM 9-2853
h. SHIPMENT AND LIMITED STORAGE.	
Army Marking Directive	TM 88 414
Army Shipping Document	TM 88 505
Inspection, Preservation, and Maintenance in Storage of Small Arms Matériel.	SR 9-65
Instruction Guide: Ordnance Packaging and Shipping (Posts, Camps, and Stations).	TM 9-2854
Ordnance Storage and Shipment Chart—Group G.	TB 9-OSSC-6
G.	
Preparation of Unboxed Ordnance Matériel for Shipment.	SR 9-4
Protection of Ordnance General Supplies in Open Storage.	TB ORD 379
Shipment of Supplies and Equipment: Report of Damaged or Improper Shipment.	SR 745-45-5
Standards for Overseas Shipment and Domestic Issue of Ordnance Matériel Other Than Ammunition and Army Aircraft.	TB ORD 385

Storage, Inspection, and Issue of Unboxed Serviceable Motor Vehicles; Preparation of Unserviceable Vehicles for Storage; and Deprocessing of Matériel Prior to Operation. SB 9-63

[AG 300.7 (20 Apr 51)]

BY ORDER OF THE SECRETARY OF THE ARMY:

OFFICIAL:

Wm. E. BERGIN

Major General, USA

Acting The Adjutant General

J. LAWTON COLLINS

Chief of Staff

United States Army

DISTRIBUTION:

Tech Svc (2) except 9 (25), Arms & Svc Bd (2); AFF (2); AA Comd (2); OS Maj Comd (10); Base Comd (2); MDW (3); LOG Comd (5); A (20), CHQ (2), D (2); R 9 (2); Bn 9 (2); C 9 (2); FC (2); Sch (5) except 9 (50); Gen Dep (2); Dep 9 (10); PE (Ord O) (5), OSD (2); PG 9 (10); Ars 9 (10); Dist 9 (10); One (1) copy to each of the following T/O&E's: 5-57, 5-184, 8-750, 10-237, 10-247, 11-95, 11-97, 11-98, 11-99, 11-107, 11-547, 11-597, 12-317, 20-1528, 53-37; SPECIAL DISTRIBUTION.

For explanation of distribution formula, see SR 310-99-1.

U. S. GOVERNMENT PRINTING OFFICE: 1951 O-314992